

REV.	DESCRIPTION	ECN NO.	NAME	DATE

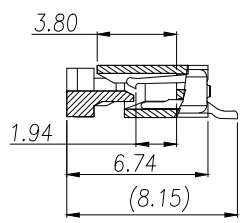

Part No	Pin	A	B	C
FC-10C4P11H25	4	3.00	5.03	11.10
FC-10C5P11H25	5	4.00	6.03	12.10
FC-10C6P11H25	6	5.00	7.03	13.10
FC-10C7P11H25	7	6.00	8.03	14.10
FC-10C8P11H25	8	7.00	9.03	15.10
FC-10C9P11H25	9	8.00	10.03	16.10
FC-10C10P11H25	10	9.00	11.03	17.10
FC-10C11P11H25	11	10.00	12.03	18.10
FC-10C12P11H25	12	11.00	13.03	19.10
.....	....	...	....	....
FC-10C40P11H25	40	(40-1)*1.0	(40+1)*1.0+0.03	(40+6)*1.0+0.10

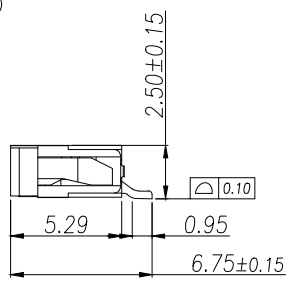
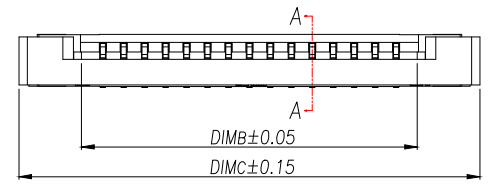
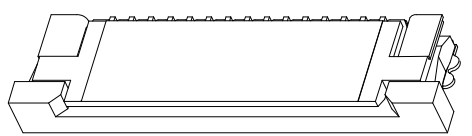
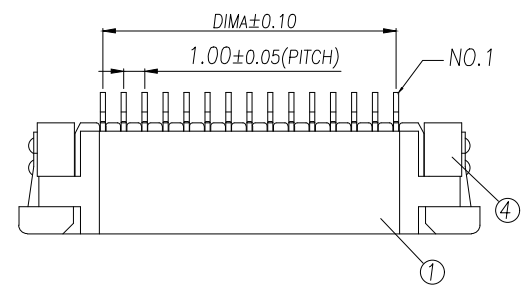
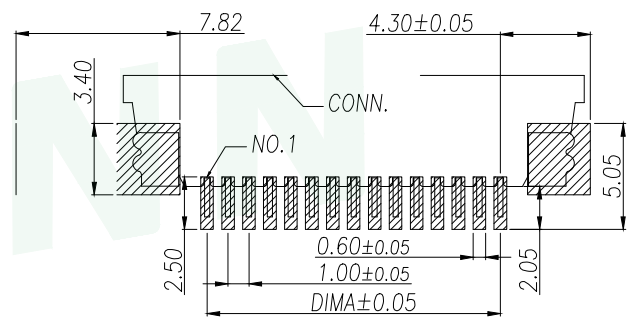
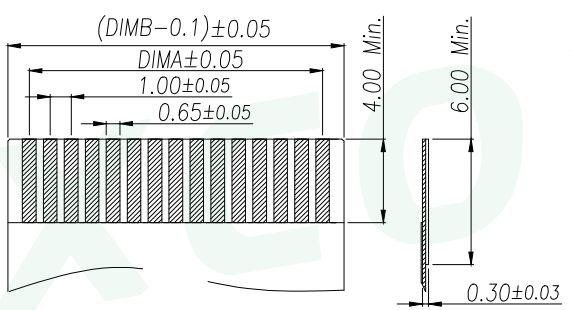
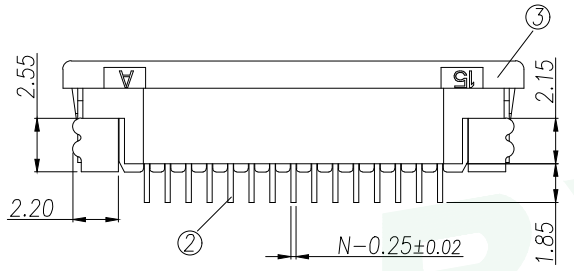

序号	品名	材质
1	1.0触点(H2.5)	LCP UL94V-0 本色
2	1.0上端子(H2.5)	铜合金/表面镀镍
3	1.0卧式后盖(H2.5)	LCP UL94V-0 黑色
4	1.0卧式弹片(H2.5)	铜合金/表面镀镍

适用扁平线(Applicable Flat Cable)

技术指标:

1. 塑件表面应光洁, 无毛边, 无明显收缩、缺陷、裂纹等现象.
2. 温度范围: -25°C~+85°C.
3. 额定电压: 50V, AC/DC.
4. 接触电阻: ≤0.03Ω.
5. 绝缘电阻: ≥500MΩ

GENERAL TOLERANCE		DONGGUAN BAOXUN PRECISION TECHNOLOGY CO., LTD			
DIM.	TOL.	TITLE: 1.0 Pitch H2.5 ZIF R/A Type Top CONN.			
X		DWG. NO.: FC-10CNP11H25		DRAWN: MAX	
X.X	±0.30	PART NO.: FC-10CNP11H25		CHECKED: ELLA	
X.XX	±0.25	UNIT: mm		APPROVED: WILL	
X.XXX	±0.15	SCALE: none	SHEET: 1 of 1	DWG. SIZE: A4	LAYER: bxconn
GENERAL ANGLE:	±3°				

**BXCONN**<sup>®</sup>



## X-ON Electronics

Largest Supplier of Electrical and Electronic Components

*Click to view similar products for [FFC & FPC Connectors](#) category:*

*Click to view products by [BXCONN](#) manufacturer:*

Other Similar products are found below :

[00-6200-227-022-800](#) [006205250500825+](#) [006205280500825+](#) [FPH-1602G](#) [086222026001800](#) [52610-0675](#) [62674-201121DLF](#) [52746-1671-TR250](#) [10051922-1610EHLF](#) [10051922-2810EHLF](#) [686322124422](#) [XF3M-2915-1B-R100](#) [AYF353125A](#) [AYF530665TA](#) [AYF534065TA](#) [20FLH-RSM1-TB](#) [PCA-7F-25-HL-3-G](#) [207356-1](#) [52807-0430](#) [FFC05011-10SBB114W5M](#) [502250-8027](#) [FH28K-40S-0.5SH](#) [200528-0260](#) [FH28K-10S-0.5SH](#) [501951-1250](#) [X05B20U43T](#) [0.5K-DX-30PWB](#) [DS1020-08-10VBT12](#) [THD0515-34CL-GF](#) [X05A10L28G](#) [ECC2841061EU](#) [1.0K-DHQX-16PWB](#) [1.0K-DHQX-30PWB](#) [1775333-6](#) [10054365-202110ELF](#) [10054365-242110ELF](#) [10054365-282110ELF](#) [10064555-392220HLF](#) [59453-041110EBHLF](#) [59453-091110EDHLF](#) [62674-241141ALF](#) [62684-432100ALF](#) [62684-451100AHLF](#) [62684-5721N0ALF](#) [HFW11R-1STE1MTLF](#) [HFW12R-1STE9LF](#) [HFW14R-1STE9MTLF](#) [HFW18S-2STE9LF](#) [HFW20R-1STAE1HLF](#) [HFW20R-1STE1MTLF](#)