

A	B	C	D	E	
REV.	DESCRIPTION		ECN NO.	NAME	DATE

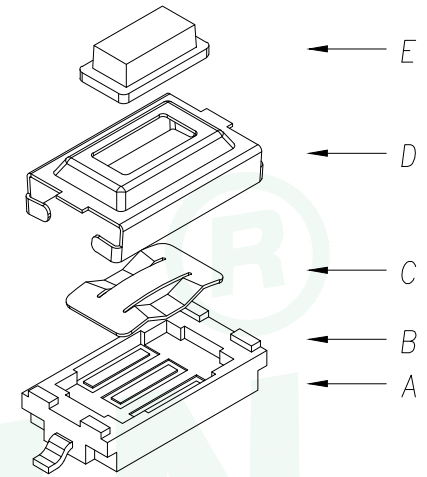
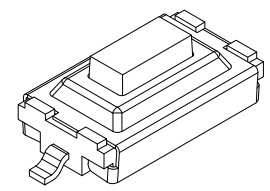
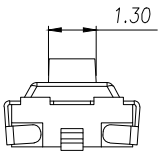
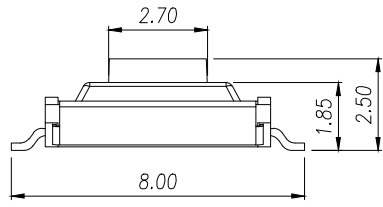

T S 1 3 0 7 - [] [] [] [] H [] []

安装方式:
 T:贴片
 C:插件
 B:沉板
 J:包脚

定位柱:
 D:带柱
 Z:不带柱

高度:
 35:3.5H
 38:3.8H
 43:4.3H

力度:
 A:160g
 B:260g

包装方式:
 M:盘装
 S:袋装

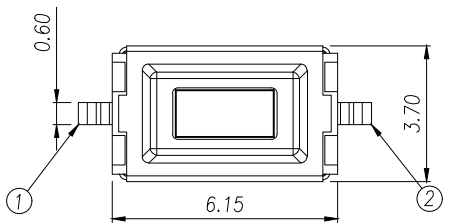

主要技术参数、性能

The Main Thchnology Performance

额定电流、电压 Rate voltage,current	50mA DC12V
接触电阻 Contact resistance	≤100mΩ
按力 Operating force	±50gf
行程 Travel	0.20±0.10mm
绝缘电阻 Insulated resistance	≥100MΩ
介电强度 Dielectric strength	≥250VAC/1min

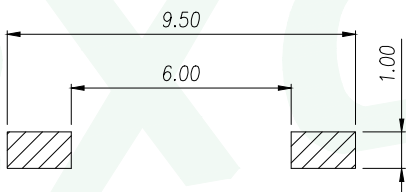

PCB.焊接图
PCB.WELDING DRAWING

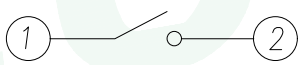

电路图
CIRCUIT DIAGRAM

E	按钮	PPA	1	白色
D	盖板	不锈钢	1	清洗
C	弹片	不锈钢	1	镀银
B	本体	PPA	1	黑色
A	卡件	黄铜	1	镀银
项目 ITEM	名称 DESCRIPTION	材质 MATERIAL	数量 QTY	表面处理/颜色 FINISH/COLOR

GENERAL TOLERANCE		DONGGUAN BAOXUN PRECISION TECHNOLOGY CO., LTD			
DIM.	TOL.	TITLE: TACT SWITCH			
X		DWG. NO.: TS1307-TZXXHXM		DRAWN: MAX	
X.X	±0.30	PART NO.: TS1307-TZXXHXM		CHECKED: ELLA	
X.XX	±0.25	APPROVED: WILL			
X.XXX	±0.15	UNIT: mm	SCALE: none	SHEET: 1 of 1	DWG. SIZE: A4
GENERAL ANGLE:	±3°	LAYER: bxconn			



X-ON Electronics

Largest Supplier of Electrical and Electronic Components

Click to view similar products for [Tactile Switches](#) category:

Click to view products by [BXCONN](#) manufacturer:

Other Similar products are found below :

[6407-250V-25273P](#) [ADTSA62NV](#) [B3F-3123](#) [1977177-8](#) [1977266-1](#) [ADTSA63NV](#) [ADTSM21NSVTR](#) [ADTSM25RVTR](#) [ADTSM32NVTR](#)
[ADTSMW64RV](#) [1977120-6](#) [FSMRA4JHA04](#) [GS4.70F300QP](#) [KSC241J SP DELTA LFS](#) [3FTL600RAS](#) [3FTL640RAS](#) [Y96K132V0FPLFS](#)
[09158](#) [6407-250V-25343P](#) [ADTSM31NVTR](#) [2-1977120-7](#) [TSJW-5.2-260-TR](#) [TME1-01-Z](#) [Y651050400P](#) [KMT011MNGJLHS](#) [70-201.0](#)
[ADTSG648NV](#) [ADTSM62KSVTR](#) [ADTSM648NV](#) [95C06E3RAT](#) [3ATH9Q](#) [FSMRA8JHA04](#) [HARS0073](#) [Y33R411N9FPLFT](#)
[Y33R51139FPLFT](#) [Y31C01402FPLFS](#) [PTS645SK50SMTR92](#) [ADTSM32NVB](#) [KMS233GPWTLFG](#) [Y78B64124FP](#) [Y33A812C5FP LFT](#)
[Y56B2D120FP LFS](#) [PTS645 DVM83-BN125-2 LFS](#) [B3W 1000G](#) [B3F 1002C](#) [B3F 0047H](#) [B3W 1002C](#) [B3F 5001G](#) [B3W 1100C](#) [1-](#)
[1571563-4](#)