

A	B	C	D	E
---	---	---	---	---

REV.	DESCRIPTION	ECN NO.	NAME	DATE

1

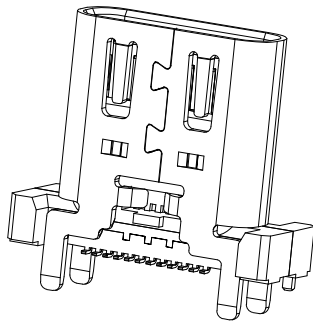
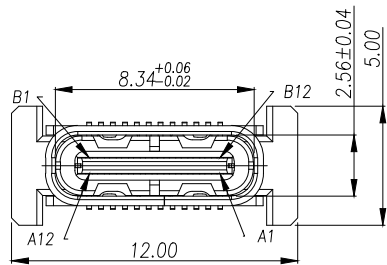

NOTE:

- MATERIAL SPECIFICATION:
  - HOUSING: PA9T, UL94 V-0.
  - TERMINAL: COPPER ALLOY (C1814)
  - MID PLATE: STAINLESS STEEL (SUS301)
  - FRONT SHELL: STAINLESS STEEL (SUS304)
- PLATING SPECIFICATION:
  - TERMINAL:
    - Ni 50u" MIN. UNDER PLATED OVER ALL.
    - Au PLATED ON THE FUNCTIONAL AREA OF CONTACT.
    - CONTACT FUNCTIONAL AREA PLATED : Au G/F
    - CONTACT SOLDER AREA PLATED : Au G/F
  - SHELL:
    - Ni 50u" MIN. UNDER PLATED OVER ALL.
  - MID PLATE:
    - CLEAR ONLY
- MECHANICAL PERFORMANCE,
  - INSERTION FORCE: 0.5~2.0kgf.
  - REMOVAL FORCE: 0.8kgf~2.0kgf.
  - DURABILITY: 10000 CYCLES.
- ELECTRICAL PERFORMANCE,
  - VOLTAGE RATING: 5 V DC/AC (RMS. max)  
CURRENT RATING: 5 AMPS. FOR TOTAL VBUS/GND PINS;  
1.25AMPS FOR CC PIN, 0.25 AMPS. FOR ALL OTHER CONTACT.
  - LLCR:
    - VBUS & GND PINS AND OTHER PINS: 40mΩ/PIN MAX.
    - SHIELD: 50mΩ/MAX.
    - LLCR MAX. CHANGE OF ALL PINS: 10mΩ.
  - INSULATION RESISTANCE: 100MΩ MIN
  - DIELECTRIC WITHSTAND VOLTAGE, AC 100V FOR 1 MINUTE.
- ENVIRONMENTAL PERFORMANCE:
  - OPERATING TEMPERATURE: -40°C~+85°C.
- IR REFLOW:
  - THE PEAK TEMPERATURE ON THE BOARD SHALL BE MAINTAINED FOR 10 SECONDS AT 260°C.

2

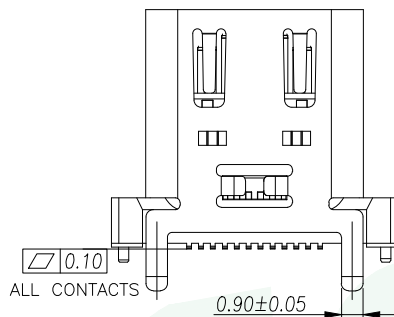
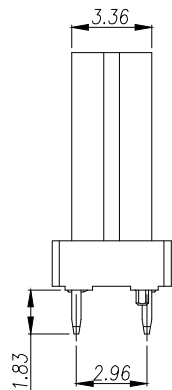
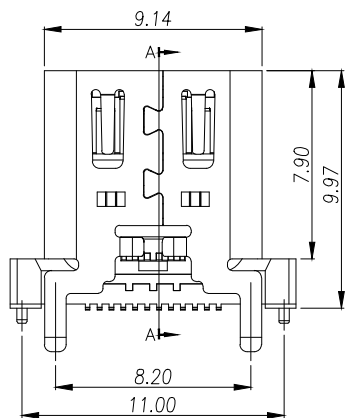

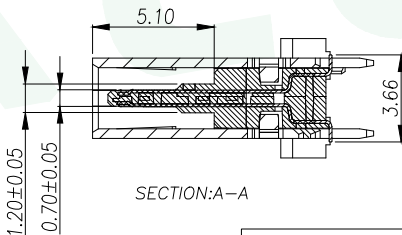
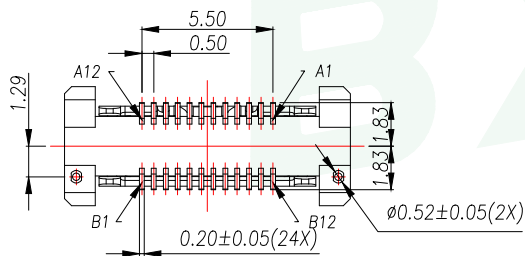

3

4



5

GENERAL TOLERANCE		DONGGUAN BAOXUN PRECISION TECHNOLOGY CO., LTD				 
DIM.	TOL.	TITLE: USB CF24P VERTICAL SMT				
X		DWG. NO.: UC04-OB24F00P11		DRAWN: MAX		
X.X	±0.30	PART NO.: UC04-OB24F00P11		CHECKED: ELLA		
X.XX	±0.25	UNIT: mm		SCALE: none	APPROVED: WILL	
X.XXX	±0.15	SHEET: 1 of 1	DWG. SIZE: A4	LAYER: bxconn		
GENERAL ANGLE:	±3°					

A

B

C

D

E

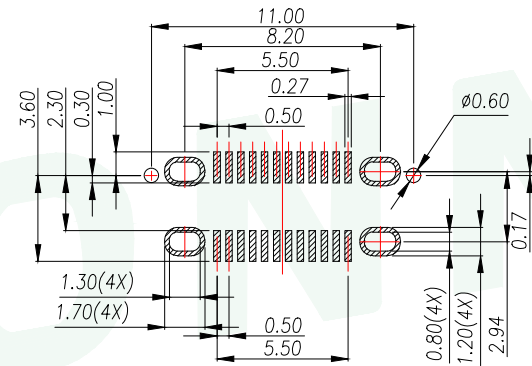
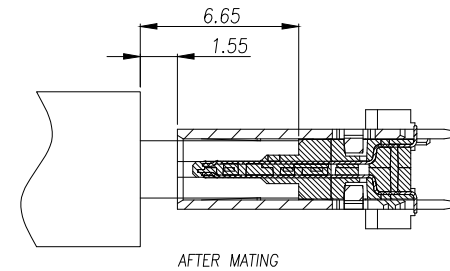
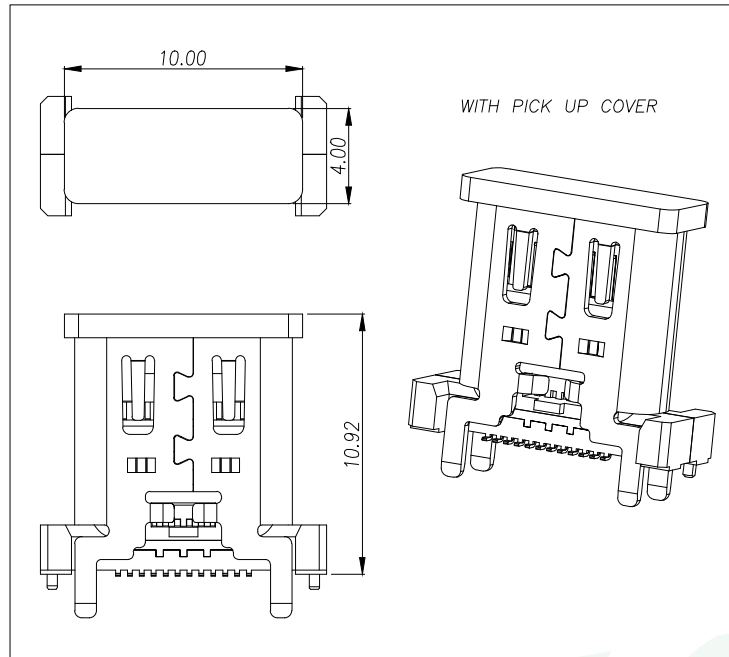

REV.	DESCRIPTION	ECN NO.	NAME	DATE



RECOMMENDED PCB LAYOUT(TOP VIEW)  
THICKNESS 1.0±0.10MM;DEFAULT TOLERANCE:±0.05

#### USB TYPE-C PIN ASSIGNMENTS

PIN NUMBER	SIGNAL NAME	PIN NUMBER	SIGNAL NAME
A1	GND	B12	GND
A2	SSTXp1	B11	SSRXp1
A3	SSTXn1	B10	SSRXn1
A4	Vbus	B9	Vbus
A5	CC1	B8	SBU2
A6	Dp1	B7	Dn2
A7	Dn1	B6	Dp2
A8	SBU1	B5	CC2
A9	Vbus	B4	Vbus
A10	SSRXn2	B3	SSTXn2
A11	SSRXp2	B2	SSTXp2
A12	GND	B1	GND

GENERAL TOLERANCE		DONGGUAN BAOXUN PRECISION TECHNOLOGY CO., LTD				 
DIM. TOL.		TITLE: USB CF24P VERTICAL SMT				
X		DWG. NO.: UC04-OB24F00P11		DRAWN: MAX		
X.X ±0.30		PART NO.: UC04-OB24F00P11		CHECKED: ELLA		
X.XX ±0.25		UNIT: mm		APPROVED: WILL		
X.XXX ±0.15		SCALE: none	SHEET: 1 of 1	DWG. SIZE: A4	LAYER: bxconn	
GENERAL ANGLE: ±3°						

## X-ON Electronics

Largest Supplier of Electrical and Electronic Components

*Click to view similar products for [USB Connectors](#) category:*

*Click to view products by [BXCONN](#) manufacturer:*

Other Similar products are found below :

[950](#) [A-USB A-LP-SMT-C](#) [A-USB B-TOP-C](#) [MUSBD11135](#) [17-200721](#) [217450-1](#) [KMBVX-TH-5S-B30](#) [KUSBX-AS2N-W](#) [KUSBX-SMT2AP1S-W30](#) [935](#) [957](#) [30-498-6](#) [SK-60A-2](#) [1734082-1](#) [30-470](#) [30-489](#) [30-541](#) [MIKROE-1451](#) [USBFTVSCCG](#) [1-1734084-2](#) [10135326-001LF](#) [4198](#) [USB-A-D-VT](#) [USB-A-S-RA-TSMT](#) [1310-1023-02](#) [690-024-633-031](#) [UB-20PMFP-LC7001](#) [17-200011](#) [UB-20AFMM-LL7A01](#) [1040870124](#) [CAP-WCCMLPB1](#) [2274475-3](#) [UB-20BMFA-SL8001](#) [914-614A2025S10200](#) [ZX40-B-5S-1500-STDA\(30\)](#) [GSB3116344HR](#) [USB3FTV2SAZNF459](#) [U221-041N-1WVS62-F5D](#) [HYCW153-USBD05-500B](#) [HYCW219-USBD05-075B](#) [HYCW148-USBD05-117B](#) [HYCW149-USBD05-740B](#) [HYCW204-USBD05-108B](#) [HYCW214-USBA04-113B](#) [HYCW213-USBA04-113B](#) [UB-20AMFM-SL7A01](#) [KMMX-BSMT35S-1-B30TR](#) [2345986-1](#) [10082141-N340LF](#) [10117836-011LF](#)