

REV.	DESCRIPTION	ECN NO.	NAME	DATE

1
2
3
4
5

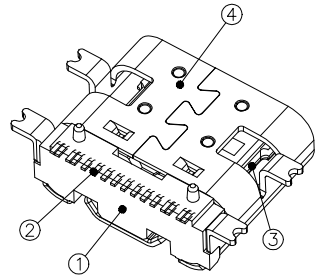

NOTE:
 1.MATERIAL SPECIFICATION:
 1.HOUSING:HIGH TEMPERATURE RESISTANT PLASTIC,UL94 V-0.
 2.TERMINAL: COPPER ALLOY(C1814)
 3.MID PLATE: STAINLESS STEEL(SUS301)
 4.FRONT SHELL: STAINLESS STEEL(SUS304)
 2.PLATING SPECIFICATION:
 2-1.TERMINAL:
 Ni 50u" MIN. UNDER PLATED OVER ALL.
 Au PLATED ON THE FUNCTIONAL AREA OF CONTACT.
 CONTACT FUNCTIONAL AREA PLATED : Au 3u"
 CONTACT SOLDER AREA PLATED : Au G/F"
 2-2.FRONT SHELL:
 Ni 30u" MIN. UNDER PLATED OVER ALL.
 2-3.MID PLATE PLATE:
 CLEAR ONLY
 3.MECHANICAL PERFORMANCE,
 3-1.INSERTION FORCE: 0.5~2.0kgf.
 3-2.REMOVAL FORCE: 0.8kgf~2.0kgf.
 3-3.DURABILITY: 10000 CYCLES.
 4.ELECTRICAL PERFORMANCE,
 4-1. VOLTAGE RATING:5 V DC/AC (RMS. max)
 CURRENT RATING:5 AMPS. FOR TOTAL VBUS/GND PINS;
 1.25AMPS FOR CC PIN,0.25 AMPS. FOR ALL OTHER CONTACT.
 4-2. LLCR:
 VBUS & GND PINS AND OTHER PINS: 40mΩ/PIN MAX.
 SHIELD: 50mΩ/MAX.
 LLCR MAX. CHANGE OF ALL PINS: 10mΩ.
 4-3.INSULATION RESISTANCE: 100MΩ MIN
 4-4.DIELECTRIC WITHSTAND VOLTAGE,AC 100V FOR 1 MINUTE.
 5. ENVIRONMENTAL PERFORMANCE:
 OPERATING TEMPERATURE: -40°C~+85°C.
 6.IR REFLOW:
 THE PEAK TEMPERATURE ON THE BOARD SHALL
 BE MAINTAINED FOR 10 SECONDS AT 260°C.

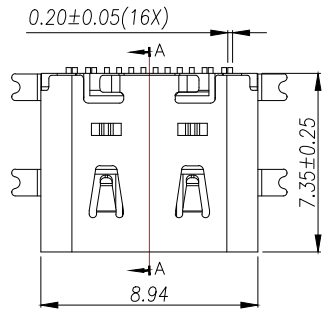
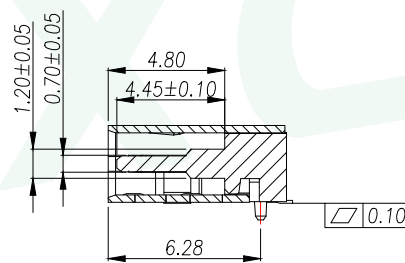
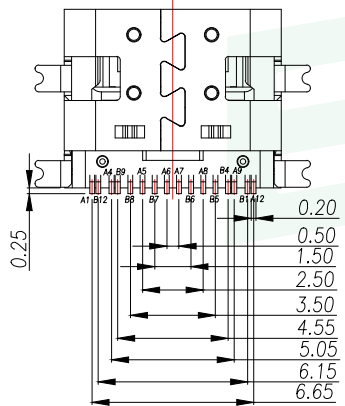
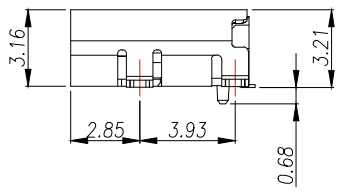
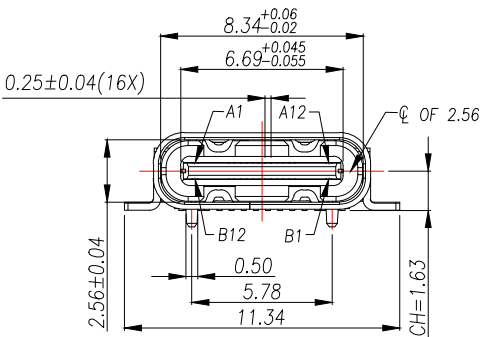

GENERAL TOLERANCE		DONGGUAN BAOXUN PRECISION TECHNOLOGY CO., LTD				
DIM. TOL.		TITLE: USB CF 16PIN (L=7.35) WITH POST				
X		DWG. NO.: UC09-2B16F00P11		DRAWN: MAX		
X.X	±0.30	PART NO.: UC09-2B16F00P11		CHECKED: ELLA		
X.XX	±0.25	UNIT: mm		APPROVED: WILL		
X.XXX	±0.15	SCALE: none	SHEET: 1 of 1	DWG. SIZE: A4	LAYER: bxconn	
GENERAL ANGLE: ±3°						

REV.	DESCRIPTION	ECN NO.	NAME	DATE

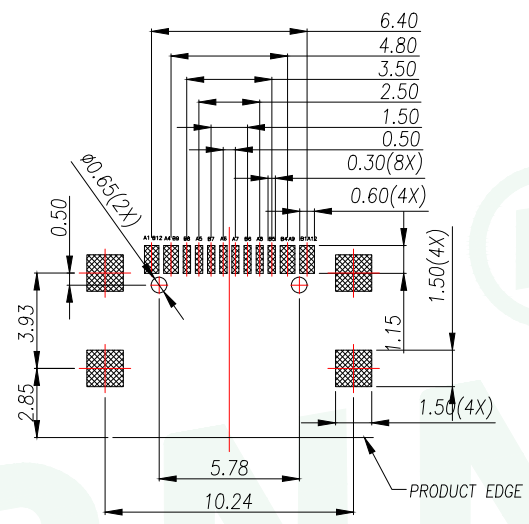
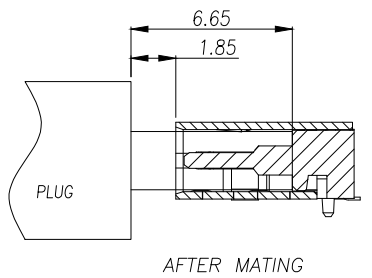



RECOMMENDED PCB LAYOUT(TOP VIEW)
THICKNESS 0.80MM;DEFAULT TOLERANCE:±0.05

USB TYPE-C PIN ASSIGNMENTS

PIN NUMBER	SIGNAL NAME	PIN NUMBER	SIGNAL NAME
A1	GND	B12	GND
A4	VBUS	B9	VBUS
A5	CC1	B8	SBU2
A6	Dp1	B7	Dn2
A7	Dn1	B6	Dp2
A8	SBU1	B5	CC2
A9	VBUS	B4	VBUS
A12	GND	B1	GND

1
2
3
4
5

GENERAL TOLERANCE		DONGGUAN BAOXUN PRECISION TECHNOLOGY CO., LTD				 
DIM.	TOL.	TITLE: USB CF 16PIN (L=7.35) WITH POST				
X		DWG. NO.: UC09-2B16F00P11		DRAWN: MAX		
X.X	±0.30	PART NO.: UC09-2B16F00P11		CHECKED: ELLA		
X.XX	±0.25	UNIT: mm		SCALE: none	APPROVED: WILL	
X.XXX	±0.15	SHEET: 1 of 1	DWG. SIZE: A4	LAYER: bxconn		
GENERAL ANGLE:	±3°					

X-ON Electronics

Largest Supplier of Electrical and Electronic Components

Click to view similar products for [USB Connectors](#) category:

Click to view products by [BXCONN](#) manufacturer:

Other Similar products are found below :

[950](#) [A-USB A-LP-SMT-C](#) [A-USB B-TOP-C](#) [MUSBD11135](#) [17-200721](#) [217450-1](#) [KMBVX-TH-5S-B30](#) [KUSBX-AS2N-W](#) [KUSBX-SMT2AP1S-W30](#) [935](#) [957](#) [30-498-6](#) [SK-60A-2](#) [1734082-1](#) [30-470](#) [30-489](#) [30-541](#) [MIKROE-1451](#) [USBFTVSCCG](#) [1-1734084-2](#) [10135326-001LF](#) [4198](#) [USB-A-D-VT](#) [USB-A-S-RA-TSMT](#) [1310-1023-02](#) [690-024-633-031](#) [UB-20PMFP-LC7001](#) [17-200011](#) [UB-20AFMM-LL7A01](#) [1040870124](#) [CAP-WCCMLPB1](#) [2274475-3](#) [UB-20BMFA-SL8001](#) [914-614A2025S10200](#) [ZX40-B-5S-1500-STDA\(30\)](#) [GSB3116344HR](#) [USB3FTV2SAZNF459](#) [U221-041N-1WVS62-F5D](#) [HYCW153-USBD05-500B](#) [HYCW219-USBD05-075B](#) [HYCW148-USBD05-117B](#) [HYCW149-USBD05-740B](#) [HYCW204-USBD05-108B](#) [HYCW214-USBA04-113B](#) [HYCW213-USBA04-113B](#) [UB-20AMFM-SL7A01](#) [KMMX-BSMT35S-1-B30TR](#) [2345986-1](#) [10082141-N340LF](#) [10117836-011LF](#)