

REV.	DESCRIPTION	ECN NO.	NAME	DATE

1

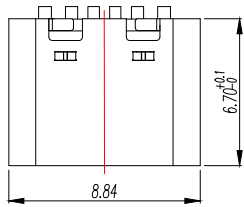

2

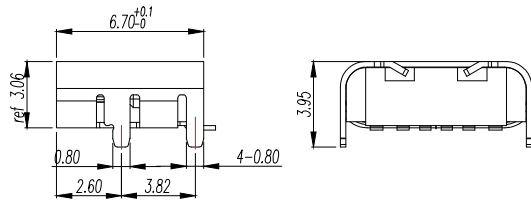
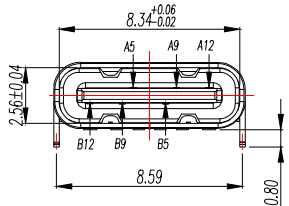

3

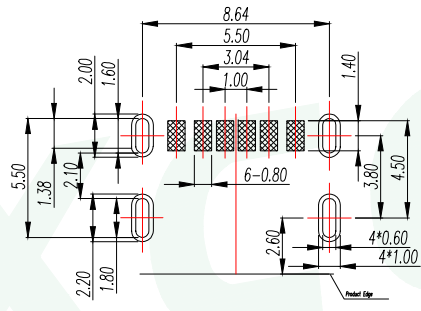
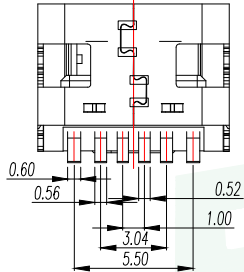

RECOMMENDED PCB LAYOUT  
GENERAL TOLERANCE ±0.05

PIN ASSIGNMENTS

A5	CC1	B12	GND
A9	VBUS	B9	VBUS
A12	GND	B5	CC2
PIN	SIGNAL NAME	PIN	SIGNAL NAME

4

5

备注(NOTE): 1 材质:

1.1 胶芯: LCP UL94 V-0

1.2 端子: (C2680, 镍底, 镀金0.5U)

1.3 外壳: 不锈钢304—表面镀镍50U

2. 电气特性:

2.1. 接触区: 接触电阻30mQMax,

允许10mΩ变化量,

测试条件: 20mv, 100mA下测量,

2.2. 额定电流: 最大3A

2.3. 额定电压: 5V.

2.4. 耐电电压: 100VAC.

2.5. 绝缘电阻: 至少100兆欧

3. 机械性能:



3.1. 插入力: 0.5—2.0Kg

3.2. 拔出力: 0.8—2.0Kg

3.3. 插拔次数: 5000+.

4. 工作环境: -20℃to +85℃

4.1. 盐雾测试: 24H

GENERAL TOLERANCE		DONGGUAN BAOXUN PRECISION TECHNOLOGY CO., LTD				 
DIM. TOL.		TITLE: TYPE-C 6P SMT 四脚插板				
X ±0.30		DWG. NO.: UC17-OB06F68011		DRAWN: MAX		
X.X ±0.25		PART NO.: UC17-OB06F68011		CHECKED: ELLA		
X.XX ±0.15		UNIT: mm		APPROVED: WILL		
X.XXX ±0.15		SCALE: none	SHEET: 1 of 1	DWG. SIZE: A4	LAYER: bxconn	
GENERAL ANGLE: ±3°						

## X-ON Electronics

Largest Supplier of Electrical and Electronic Components

*Click to view similar products for [USB Connectors](#) category:*

*Click to view products by [BXCONN](#) manufacturer:*

Other Similar products are found below :

[950](#) [A-USB A-LP-SMT-C](#) [A-USB B-TOP-C](#) [MUSBD11135](#) [17-200721](#) [217450-1](#) [KMBVX-TH-5S-B30](#) [KUSBX-AS2N-W](#) [KUSBX-SMT2AP1S-W30](#) [935](#) [957](#) [30-498-6](#) [SK-60A-2](#) [1734082-1](#) [30-470](#) [30-489](#) [30-541](#) [MIKROE-1451](#) [USBFTVSCCG](#) [1-1734084-2](#) [10135326-001LF](#) [4198](#) [USB-A-D-VT](#) [USB-A-S-RA-TSMT](#) [1310-1023-02](#) [690-024-633-031](#) [UB-20PMFP-LC7001](#) [17-200011](#) [UB-20AFMM-LL7A01](#) [1040870124](#) [CAP-WCCMLPB1](#) [2274475-3](#) [UB-20BMFA-SL8001](#) [914-614A2025S10200](#) [ZX40-B-5S-1500-STDA\(30\)](#) [GSB3116344HR](#) [USB3FTV2SAZNF459](#) [U221-041N-1WVS62-F5D](#) [HYCW153-USBD05-500B](#) [HYCW219-USBD05-075B](#) [HYCW148-USBD05-117B](#) [HYCW149-USBD05-740B](#) [HYCW204-USBD05-108B](#) [HYCW214-USBA04-113B](#) [HYCW213-USBA04-113B](#) [UB-20AMFM-SL7A01](#) [KMMX-BSMT35S-1-B30TR](#) [2345986-1](#) [10082141-N340LF](#) [10117836-011LF](#)