

REV.	DESCRIPTION	ECN NO.	NAME	DATE

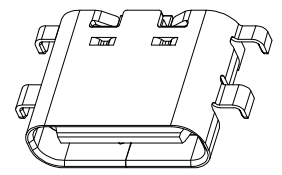

备注(NOTE): 1 材质:
 1.1 胶芯: LCP UL94 V-0
 1.2 端子: C2680(H65); 镀底, 镀金0.5U
 1.3 外壳: 不锈钢201—表面镀镍50U
 2. 电气特性:
 2.1. 接触区: 接触电阻30mQMax, 允许10mΩ变化量,
 测试条件: 20mv, 100mA下测量,
 2.2. 额定电流: 最大3A
 2.3. 额定电压: 5V.
 2.4. 耐电压: 100VAC.
 2.5. 绝缘电阻: 至少100兆欧
 3. 机械性能:
 3.1. 插入力: 0.5—2.0Kg
 3.2. 拔出力: 0.8—2.0Kg
 3.3. 插拔次数: 5000+.
 4. 工作环境: -20℃to +85℃
 4.1. 盐雾测试: 24H

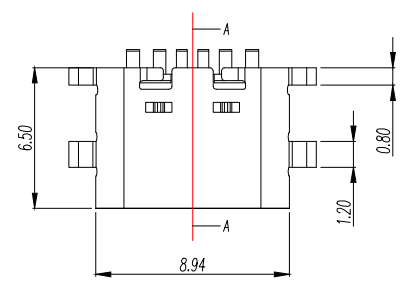
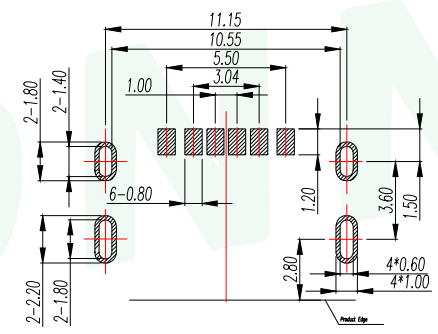
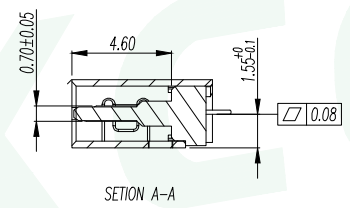
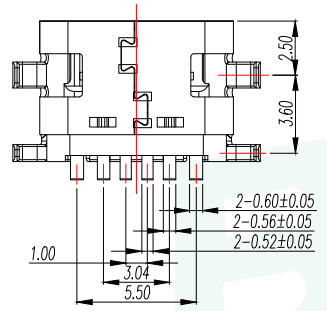
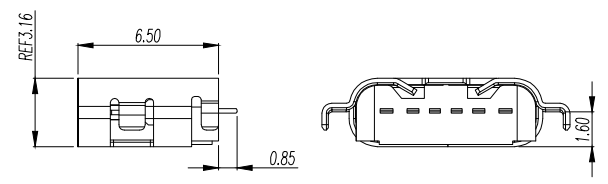
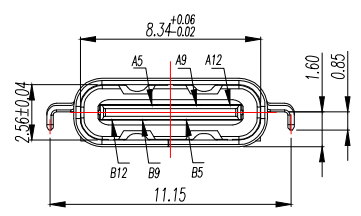

RECOMMENDED PCB LAYOUT
 GENERAL TOLERANCE ±0.05

PIN ASSIGNMENTS

A5	CC1	B12	GND
A9	VBUS	B9	VBUS
A12	GND	B5	CC2
PIN	SIGNAL NAME	PIN	SIGNAL NAME

GENERAL TOLERANCE	DONGGUAN BAOXUN PRECISION TECHNOLOGY CO., LTD				
DIM. TOL.	TITLE: USB-typeC 6pin 规格书 1.6/6.5H				
X ±0.30	DWG. NO.: UC19-OB06F65011		DRAWN: MAX		
X.X ±0.25	PART NO.: UC19-OB06F65011		CHECKED: ELLA		
X.XX ±0.15	UNIT: mm	SCALE: none	SHEET: 1 of 1	DWG. SIZE: A4	LAYER: bxconn
X.XXX ±0.15	APPROVED: WILL				
GENERAL ANGLE: ±3°					



X-ON Electronics

Largest Supplier of Electrical and Electronic Components

Click to view similar products for [USB Connectors](#) category:

Click to view products by [BXCONN](#) manufacturer:

Other Similar products are found below :

[950](#) [A-USB A-LP-SMT-C](#) [A-USB B-TOP-C](#) [MUSBD11135](#) [17-200721](#) [217450-1](#) [KMBVX-TH-5S-B30](#) [KUSBX-AS2N-W](#) [KUSBX-SMT2AP1S-W30](#) [935](#) [957](#) [30-498-6](#) [SK-60A-2](#) [1734082-1](#) [30-470](#) [30-489](#) [30-541](#) [MIKROE-1451](#) [USBFTVSCCG](#) [1-1734084-2](#) [10135326-001LF](#) [4198](#) [USB-A-D-VT](#) [USB-A-S-RA-TSMT](#) [1310-1023-02](#) [690-024-633-031](#) [UB-20PMFP-LC7001](#) [17-200011](#) [UB-20AFMM-LL7A01](#) [1040870124](#) [CAP-WCCMLPB1](#) [2274475-3](#) [UB-20BMFA-SL8001](#) [914-614A2025S10200](#) [ZX40-B-5S-1500-STDA\(30\)](#) [GSB3116344HR](#) [USB3FTV2SAZNF459](#) [U221-041N-1WVS62-F5D](#) [HYCW153-USBD05-500B](#) [HYCW219-USBD05-075B](#) [HYCW148-USBD05-117B](#) [HYCW149-USBD05-740B](#) [HYCW204-USBD05-108B](#) [HYCW214-USBA04-113B](#) [HYCW213-USBA04-113B](#) [UB-20AMFM-SL7A01](#) [KMMX-BSMT35S-1-B30TR](#) [2345986-1](#) [10082141-N340LF](#) [10117836-011LF](#)