

REV.	DESCRIPTION	ECN NO.	NAME	DATE

1

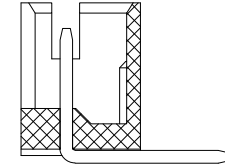
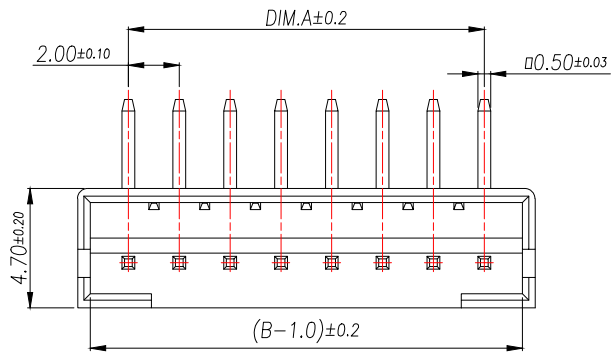

SECTION A-A

PRELIMINARY
DESIGN IS SUBJECT
TO CHANGE WITHOUT
PRIOR NOTICE

2

- 技术要求:
- 1、塑件材料:PA66 (UL-94V-0)
 - 2、接触件:黄铜镀锡
 - 3、接触电阻: ≤10mΩ
 - 4、绝缘电阻: ≥1000MΩ
 - 5、额定电压:250V AC DC
 - 6、额定电流:2.0A AC DC
 - 7、耐压:能承受1000V AC/Min ute
 - 8、工作温度: -25° ~ +85°
 - 9、可焊性试验:浸锡面积≥95%温度220⁺⁵₀,时间 2.5±0.5秒
 - 10、铅和铜等六大有害物质含量要符合环保要求

Part No	PIN	A	B
WF-1B200A2P-Y	2	2	6
WF-1B200A3P-Y	3	4	8
WF-1B200A4P-Y	4	6	10
WF-1B200A5P-Y	5	8	12
WF-1B200A6P-Y	6	10	14
WF-1B200A7P-Y	7	12	16
WF-1B200A8P-Y	8	14	18
WF-1B200A9P-Y	9	16	20
WF-1B200A10P-Y	10	18	22
WF-1B200A11P-Y	11	20	24
WF-1B200A12P-Y	12	22	26
WF-1B200A13P-Y	13	24	28
...
WF-1B200A20P-Y	20	(20-1)*2	(20+1)*2

3

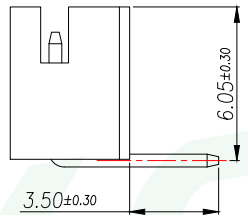
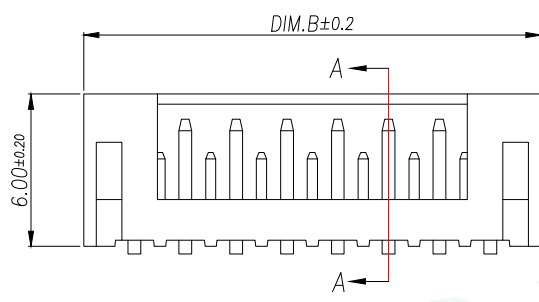

4

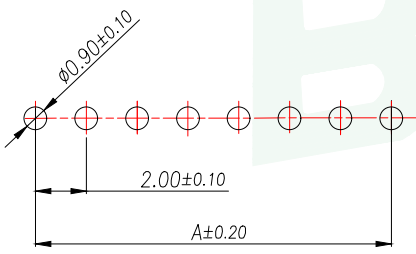

SUGGESTED PCB LAYOUT
(COMPONENT SIDE)

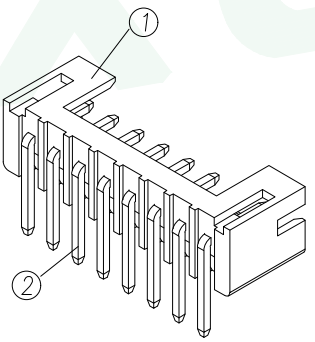

5

2	Contact	Brass	n*1	电镀(锡): 整个表面镀底镍30u"MIN,再镀锡80u".MIN.
1	Wafer	PA66(UL94V-0)	1	黄色
序号	名称	材料	数量	附注

GENERAL TOLERANCE: DONGGUAN BAOXUN PRECISION TECHNOLOGY CO., LTD

DIM.	TOL.
X	
X.X	±0.30
X.XX	±0.25
X.XXX	±0.15
GENERAL ANGLE:	±3°

TITLE: WAFER 2.0mm H6.0mm 90° DIP 黄色

DWG. NO.: WF-1B200ANP-Y

DRAWN: MAX

PART NO.: WF-1B200ANP-Y

CHECKED: ELLA

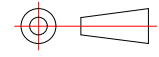

UNIT: mm	SCALE: none	SHEET: 1 of 1	DWG. SIZE: A4	LAYER: bxconn	APPROVED: WILL
----------	-------------	---------------	---------------	---------------	----------------

BXCONN[®]



X-ON Electronics

Largest Supplier of Electrical and Electronic Components

Click to view similar products for [Headers & Wire Housings](#) category:

Click to view products by [BXCONN](#) manufacturer:

Other Similar products are found below :

[0015917161](#) [0022155065](#) [57102-F02-18ULF](#) [58102-G61-06LF](#) [582553-1](#) [01.001.5753.1](#) [0050291907](#) [02.125.8002.8](#) [609-3404](#) [61062-3](#)
[CSU011177004](#) [622-0430](#) [622-3653LF](#) [63453-116](#) [636-1030](#) [636-1427](#) [636-3427](#) [636-4007](#) [641938-9](#) [65495-038](#) [65692-001LF](#) [65781-018](#)
[65781-047](#) [65817-010LF](#) [65817-015LF](#) [67095-007LF](#) [67601157](#) [68631-112](#) [699319-000](#) [70.362.1628.0](#) [70-4210](#) [70-4226B](#) [70-4853B](#) [707-](#)
[5028](#) [71.350.2428.0](#) [733-134](#) [733-162](#) [760-3052](#) [MHR-64-VUAL](#) [80.063.4001.1](#) [800-90-001-10-001000](#) [801-43-002-10-013000](#)
[801-43-006-10-002000](#) [803-43-024-10-001000](#) [803-93-012-10-001000](#) [8-1437020-4](#) [819-22-004-30-001101](#) [820-22-006-30-001101](#)
[820-22-008-30-001101](#) [821-22-002-10-001101](#)