

REV.	DESCRIPTION	ECN NO.	NAME	DATE

1

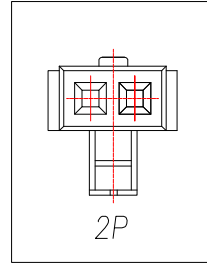
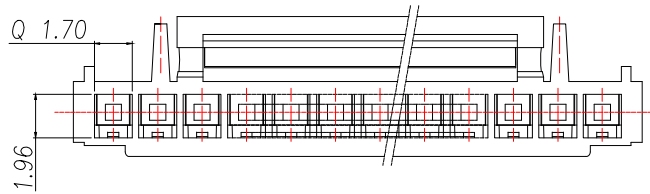

技术要求 Specification:

1. 材质 Material: PA66 UL94V-0:
2. 额定电流 Current rating: 2.0A AC, DC
3. 额定电压 Voltage rating: 250V AC, DC
4. 温度范围 Temperature range: -25°C to +85°C
5. 接触电阻 Contact resistance: $\leq 20m\Omega$
6. 绝缘电阻 Insulation resistance: $\geq 1000M\Omega$
7. 耐压 Withstand voltage: 500V AC/minute
8. 塑件表面平整光洁, 无明显的毛刺、气泡、变形、浇口拉伤、缺料等不良现象。

Plastic surface smooth and clean, no obvious glitches, bubbles, distortion, gate strain, lack of material and other undesirable phenomena.

2

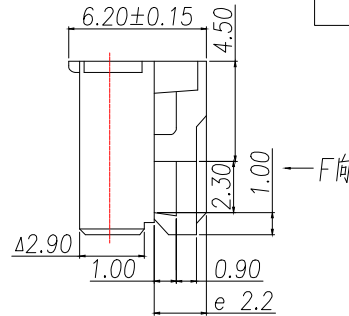
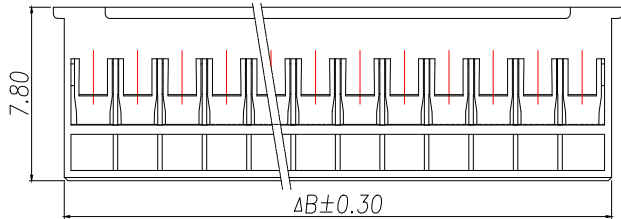

3

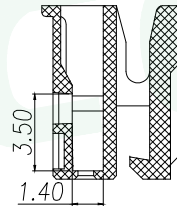
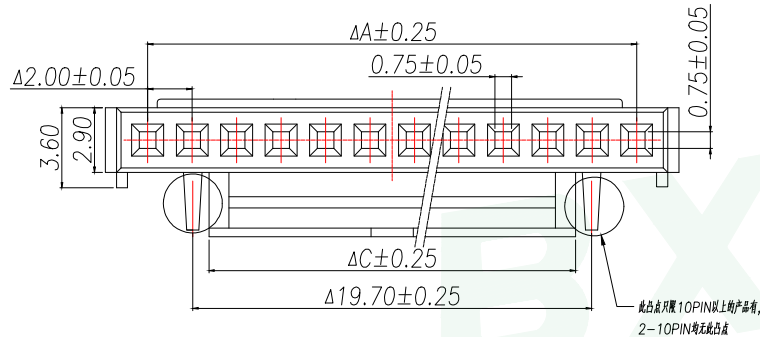

4

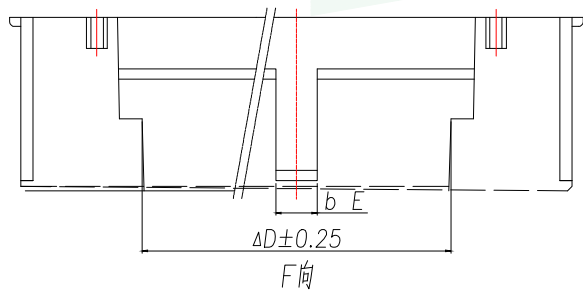

Part No	Pin	A	B	C	D	E
WF-1D200B2P	2	2.00	4.70	2.30	1.00	0.60
WF-1D200B3P	3	4.00	6.70	2.30	1.00	0.60
WF-1D200B4P	4	6.00	8.70	4.30	1.70	1.00
WF-1D200B5P	5	8.00	10.70	4.30	1.70	1.00
WF-1D200B6P	6	10.00	12.70	8.30	5.90	1.95
WF-1D200B7P	7	12.00	14.70	10.30	7.90	1.95
WF-1D200B8P	8	14.00	16.70	12.30	9.90	1.95
WF-1D200B9P	9	16.00	18.70	12.30	9.90	1.95
WF-1D200B10P	10	18.00	20.70	12.30	9.90	1.95
WF-1D200B11P	11	20.00	22.70	16.30	13.90	1.95
WF-1D200B12P	12	22.00	24.70	16.30	13.90	1.95
WF-1D200B13P	13	24.00	26.70	16.30	13.90	1.95
WF-1D200B14P	14	26.00	28.70	16.30	13.90	1.95
WF-1D200B15P	15	28.00	30.70	16.30	13.90	1.95
WF-1D200B16P	16	30.00	32.70	16.30	13.90	1.95

5

GENERAL TOLERANCE	DONGGUAN BAOXUN PRECISION TECHNOLOGY CO., LTD				
DIM. TOL.	TITLE: HY2.0MM HOUSING				
X	DWG. NO.: WF-1D200BNP		DRAWN: MAX		
X.X ±0.30	PART NO.: WF-1D200BNP		CHECKED: ELLA		
X.XX ±0.25	UNIT: mm	SCALE: none	SHEET: 1 of 1	DWG. SIZE: A4	LAYER: bxconn
X.XXX ±0.15	APPROVED: WILL				
GENERAL ANGLE: ±3°					



X-ON Electronics

Largest Supplier of Electrical and Electronic Components

Click to view similar products for [Headers & Wire Housings](#) category:

Click to view products by [BXCONN](#) manufacturer:

Other Similar products are found below :

[0015917161](#) [0022155065](#) [57102-F02-18ULF](#) [58102-G61-06LF](#) [582553-1](#) [01.001.5753.1](#) [0050291907](#) [02.125.8002.8](#) [609-3404](#) [61062-3](#)
[CSU011177004](#) [622-0430](#) [622-3653LF](#) [63453-116](#) [636-1030](#) [636-1427](#) [636-3427](#) [636-4007](#) [641938-9](#) [65495-038](#) [65692-001LF](#) [65781-018](#)
[65781-047](#) [65817-010LF](#) [65817-015LF](#) [67095-007LF](#) [67601157](#) [68631-112](#) [699319-000](#) [70.362.1628.0](#) [70-4210](#) [70-4226B](#) [70-4853B](#) [707-](#)
[5028](#) [71.350.2428.0](#) [733-134](#) [733-162](#) [760-3052](#) [MHR-64-VUAL](#) [80.063.4001.1](#) [800-90-001-10-001000](#) [801-43-002-10-013000](#)
[801-43-006-10-002000](#) [803-43-024-10-001000](#) [803-93-012-10-001000](#) [8-1437020-4](#) [819-22-004-30-001101](#) [820-22-006-30-001101](#)
[820-22-008-30-001101](#) [821-22-002-10-001101](#)