

REV.	DESCRIPTION	ECN NO.	NAME	DATE

1

NOTES:

1. Working temp: -25°C~85°C.
2. Voltage rating: 50V AC/DC(rms)
3. Contact resistance: 40mΩ max.
4. Insulation resistance: 100MΩ min.
5. Current rating: 1A AV/DC
6. Withstanding Voltage: 500V AC/minute
7. Pin Retention Force: 3N min.
8. Housing material: LCP UL94-V0, Natural
9. Terminal materl: Brass,
plating Ni 40u" min , plating Tin 100u" min.
10. Solder tab material: Brass,
plating Ni 40u" min , plating Tin 100u" min.

2

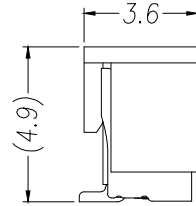
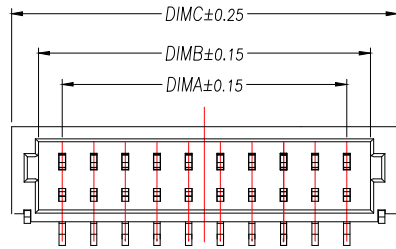

3

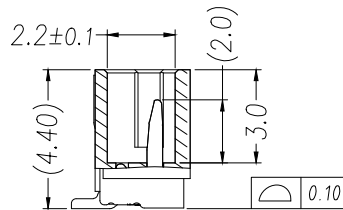
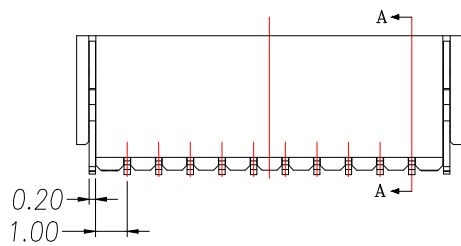

SECTION A-A

4

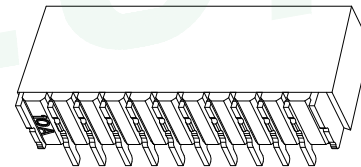
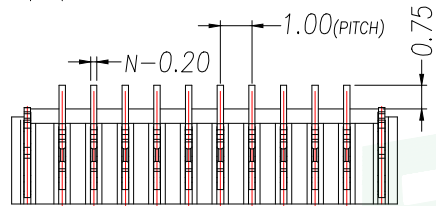

PIN	NO.	Dim A	Dim B	Dim C
2	WF-1E11002P	1.00	2.50	4.20
3	WF-1E11003P	2.00	3.50	5.20
4	WF-1E11004P	3.00	4.50	6.20
5	WF-1E11005P	4.00	5.50	7.20
6	WF-1E11006P	5.00	6.50	8.20
7	WF-1E11007P	6.00	7.50	9.20
8	WF-1E11008P	7.00	8.50	10.20
9	WF-1E11009P	8.00	9.50	11.20
10	WF-1E110010P	9.00	10.50	12.20
11	WF-1E110011P	10.00	11.50	13.20
12	WF-1E110012P	11.00	12.50	14.20
13	WF-1E110013P	12.00	13.50	15.20
14	WF-1E110014P	13.00	14.50	16.20
15	WF-1E110015P	14.00	15.50	17.20
16	WF-1E110016P	15.00	16.50	18.20

5

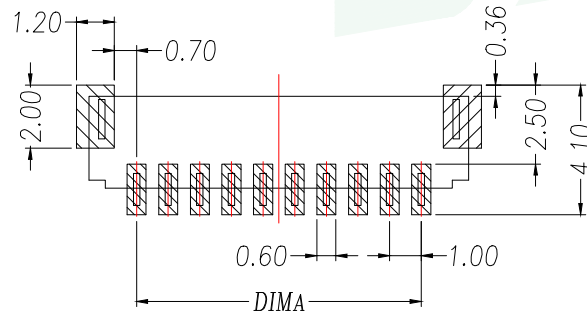

RECOMMENDED PCB LAYOUT TOP VIEW (TOLERANCE:±0.05)

SMT SOLDER AREA

GENERAL TOLERANCE	DONGGUAN BAOXUN PRECISION TECHNOLOGY CO., LTD				
DIM. TOL.	TITLE: 线对板针座 间距: SH1.0 立式贴片				
X.X ±0.30	DWG. NO.: WF-1E100ANP		DRAWN: MAX		
X.XX ±0.25	PART NO.: WF-1E100ANP		CHECKED: ELLA		
X.XXX ±0.15	UNIT: mm		APPROVED: WILL		
GENERAL ANGLE: ±3°	SCALE: none	SHEET: 1 of 1	DWG. SIZE: A4	LAYER: bxconn	

REV.	DESCRIPTION	ECN NO.	NAME	DATE

1

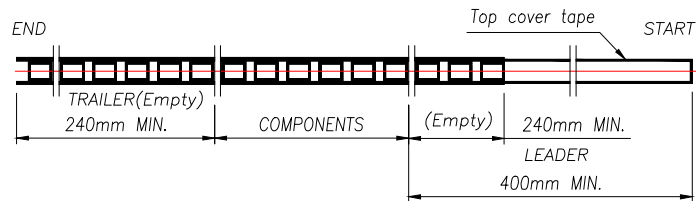

2

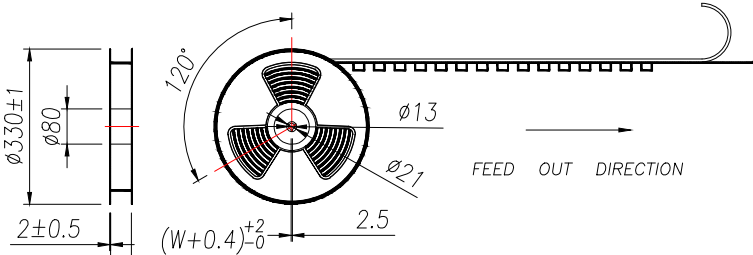

3

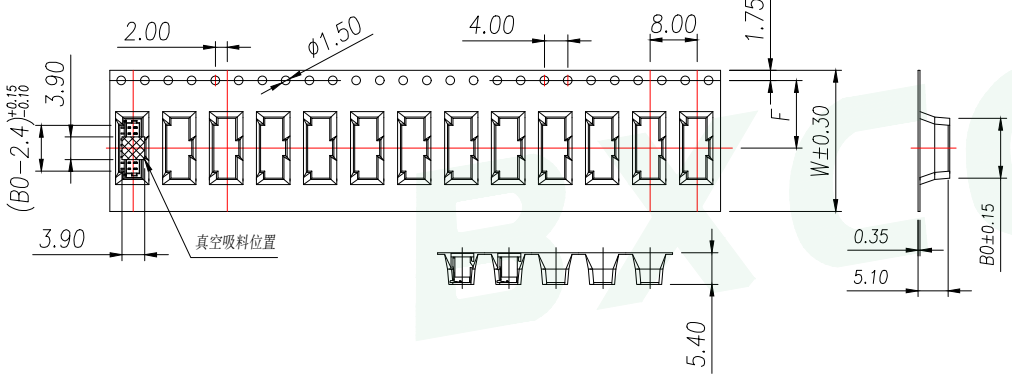

4

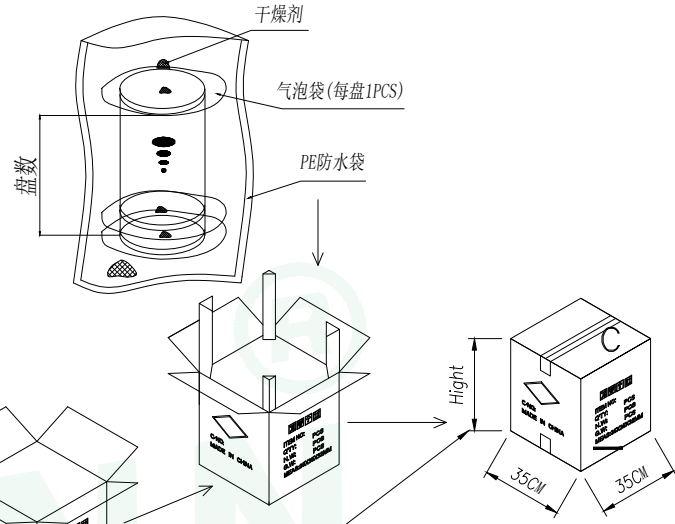

Carton Type	Small Siz	Medium	Standard
Hight(CM)	7.5	15	32

- NOTE:
- 1.10 SPROCKET HOLE PITCH CUMULATIVE TOLERANCE $\pm 0.2\text{mm}$.
 - 2.CARRIER CAMBER NOT TO EXCEED 1mm IN 100mm.
 - 3.ALL DIMENSIONS MEET EIA-481 REQUIREMENTS.
 - 4.MATERIAL: CLEAR ANTISTATIC PS, COLD SEALING.
 - 5.COMPONENT LOAD PER REEL: 1500 PCS.

PIN	NO.	B0	Dim W	Dim F	PCS/RELL	RELL/CARTON	PCS/CARTON
2	WF-1E11002P	4.15	16	7.50	1500	14	21000
3	WF-1E11003P	5.15					
4	WF-1E11004P	6.15					
5	WF-1E11005P	7.15					
6	WF-1E11006P	8.15	24	11.50	1500	10	15000
7	WF-1E11007P	9.15					
8	WF-1E11008P	10.15					
9	WF-1E11009P	11.15					
10	WF-1E110010P	12.15					
11	WF-1E110011P	13.15					
12	WF-1E110012P	14.15					
13	WF-1E110013P	15.15					

5

GENERAL TOLERANCE		DONGGUAN BAOXUN PRECISION TECHNOLOGY CO., LTD					
DIM.	TOL.	TITLE: 线对板针座 间距: SH1.0 立式贴片					
X		DWG. NO.: WF-1E100ANP					
X.X	± 0.30						DRAWN: MAX
X.XX	± 0.25	PART NO.: WF-1E100ANP					
X.XXX	± 0.15					CHECKED: ELLA	
GENERAL ANGLE: $\pm 3^\circ$		UNIT: mm	SCALE: none	SHEET: 1 of 1	DWG. SIZE: A4	LAYER: bxconn	APPROVED: WILL

REV.	DESCRIPTION	ECN NO.	NAME	DATE

1

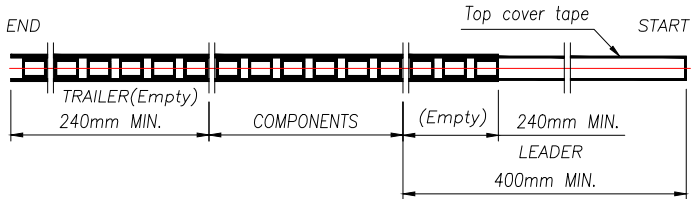

2

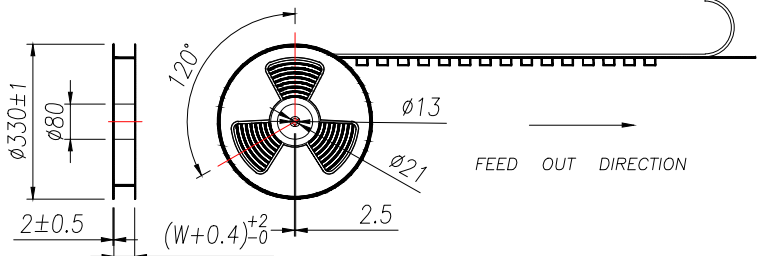

3

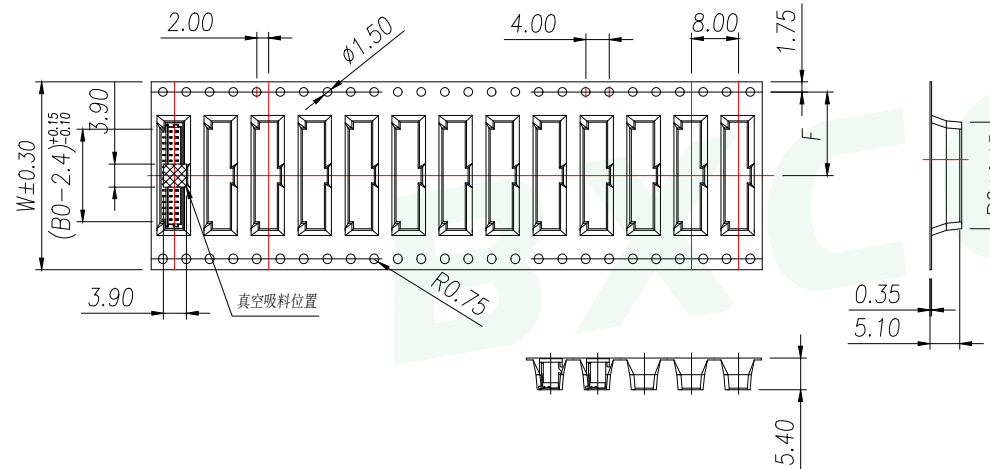

4

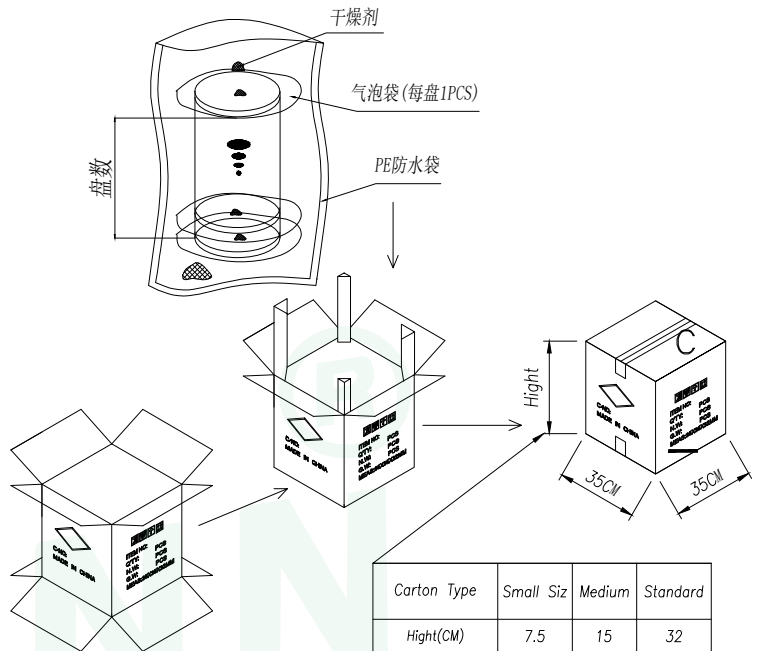

Carton Type	Small Siz	Medium	Standard
Height(CM)	7.5	15	32

- NOTE:
- 1.10 SPROCKET HOLE PITCH CUMULATIVE TOLERANCE $\pm 0.2\text{mm}$.
 - 2.CARRIER CAMBER NOT TO EXCEED 1mm IN 100mm.
 - 3.ALL DIMENSIONS MEET EIA-481 REQUIREMENTS.
 - 4.MATERIAL: CLEAR ANTISTATIC PS. COLD SEALING.
 - 5.COMPONENT LOAD PER REEL: 1500 PCS.

5

PIN	NO.	B0	Dim W	Dim F	PCS/RELL	RELL/CARTON	PCS/CARTON
14	WF-1E110014P	16.15	32	14.2	1500	8	12000
15	WF-1E110015P	17.15					
16	WF-1E110016P	18.15					

GENERAL TOLERANCE		DONGGUAN BAOXUN PRECISION TECHNOLOGY CO., LTD				
DIM. TOL.		TITLE: 线对板针座 间距: SH1.0 立式贴片				
X		DWG. NO.: WF-1E100ANP		DRAWN: MAX		
X.X		PART NO.: WF-1E100ANP		CHECKED: ELLA		
X.XX		UNIT: mm		APPROVED: WILL		
X.XXX		SCALE: none	SHEET: 1 of 1	DWG. SIZE: A4	LAYER: bxconn	
GENERAL ANGLE: $\pm 3^\circ$						

X-ON Electronics

Largest Supplier of Electrical and Electronic Components

Click to view similar products for [Headers & Wire Housings](#) category:

Click to view products by [BXCONN](#) manufacturer:

Other Similar products are found below :

[0015917161](#) [0022155065](#) [57102-F02-18ULF](#) [58102-G61-06LF](#) [582553-1](#) [01.001.5753.1](#) [0050291907](#) [02.125.8002.8](#) [609-3404](#) [61062-3](#)
[CSU011177004](#) [622-0430](#) [622-3653LF](#) [63453-116](#) [636-1030](#) [636-1427](#) [636-3427](#) [636-4007](#) [641938-9](#) [65495-038](#) [65692-001LF](#) [65781-018](#)
[65781-047](#) [65817-010LF](#) [65817-015LF](#) [67095-007LF](#) [67601157](#) [68631-112](#) [699319-000](#) [70.362.1628.0](#) [70-4210](#) [70-4226B](#) [70-4853B](#) [707-](#)
[5028](#) [71.350.2428.0](#) [733-134](#) [733-162](#) [760-3052](#) [MHR-64-VUAL](#) [80.063.4001.1](#) [800-90-001-10-001000](#) [801-43-002-10-013000](#)
[801-43-006-10-002000](#) [803-43-024-10-001000](#) [803-93-012-10-001000](#) [8-1437020-4](#) [819-22-004-30-001101](#) [820-22-006-30-001101](#)
[820-22-008-30-001101](#) [821-22-002-10-001101](#)