

A		B		C		D		E	
REV.	DESCRIPTION				ECN NO.	NAME	DATE		

NOTES:

- Working temp: -25°C~85°C.
- Voltage rating: 50V AC/DC(rms)
- Contact resistance: 40mΩ max.
- Insulation resistance: 100MΩ min.
- Current rating: 1A AV/DC
- Withstanding Voltage: 500V AC/minute
- Pin Retention Force: 5N min.
- Housing material: LCP UL94-V0, Natural
- Terminal materl: Brass,
plating Ni 40u" min , plating Tin 100u"min.
- Solder tab material: Brass,
plating Ni 40u" min , plating Tin 100u"min.

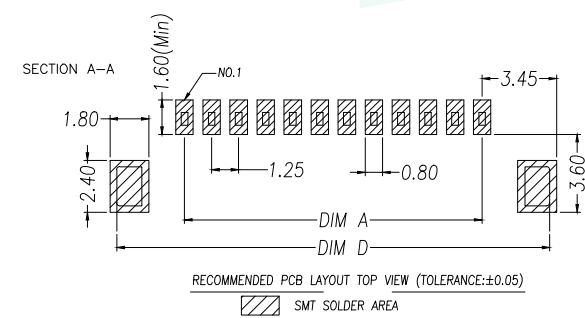
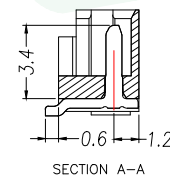
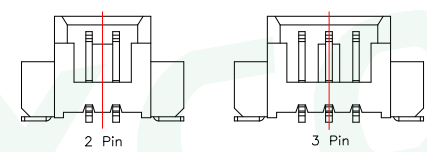
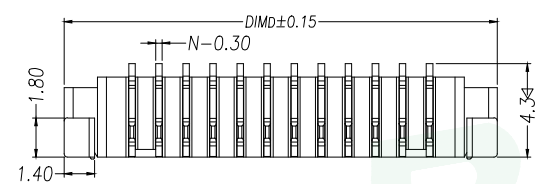
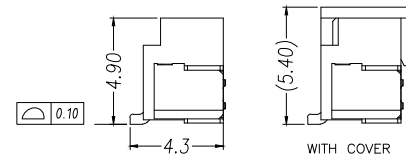
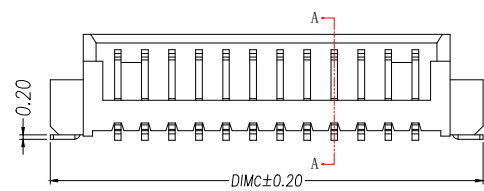
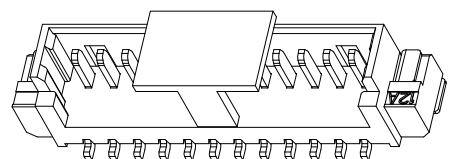
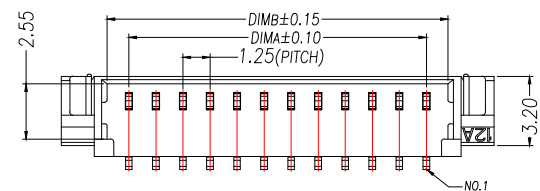

PIN	NO.	Dim A	Dim B	Dim C	Dim D
2	WF-1E125A2P	1.25	3.25	7.50	7.50
3	WF-1E125A3P	2.50	4.50	8.75	8.75
4	WF-1E125A4P	3.75	5.75	10.00	10.00
5	WF-1E125A5P	5.00	7.00	11.25	11.25
6	WF-1E125A6P	6.25	8.25	12.50	12.50
7	WF-1E125A7P	7.50	9.50	13.75	13.75
8	WF-1E125A8P	8.75	10.75	15.00	15.00
9	WF-1E125A9P	10.00	12.00	16.25	16.25
10	WF-1E125A10P	11.25	13.25	17.50	17.50
11	WF-1E125A11P	12.50	14.50	18.75	18.75
12	WF-1E125A12P	13.75	15.75	20.00	20.00
13	WF-1E125A13P	15.00	17.00	21.25	21.25
14	WF-1E125A14P	16.25	18.25	22.50	22.50
15	WF-1E125A15P	17.50	19.50	23.75	23.75
16	WF-1E125A16P	18.75	20.75	25.00	25.00

GENERAL TOLERANCE		DONGGUAN BAOXUN PRECISION TECHNOLOGY CO., LTD				
DIM.	TOL.	TITLE: 线对板针座 MX1.25 立式贴片				
X		DWG. NO.: WF-1E125ANP		DRAWN: MAX		
X.X	±0.30	PART NO.: WF-1E125ANP		CHECKED: ELLA		
X.XX	±0.25	UNIT: mm		APPROVED: WILL		
X.XXX	±0.15	SCALE: none	SHEET: 1 of 1	DWG. SIZE: A4	LAYER: bxconn	
GENERAL ANGLE: ±3°						

A		B		C		D		E	
REV.	DESCRIPTION				ECN NO.	NAME	DATE		

1

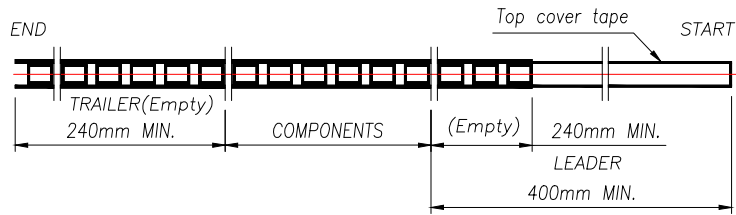

2

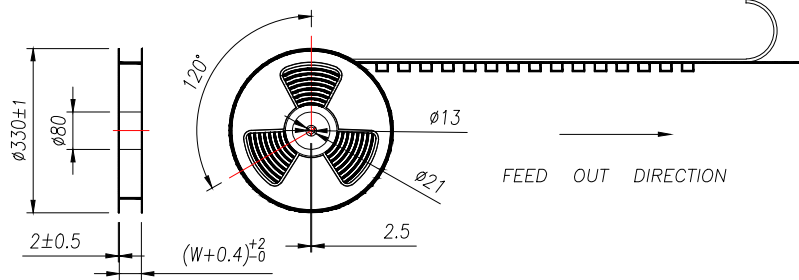

3

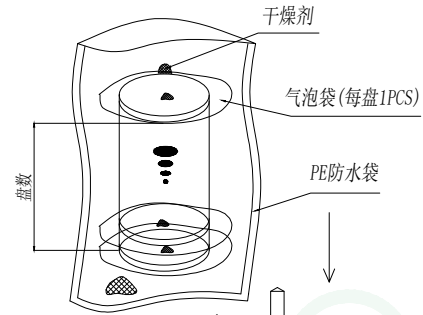

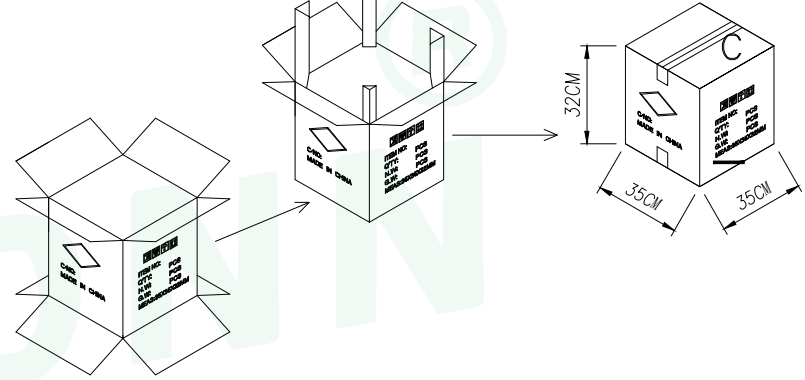
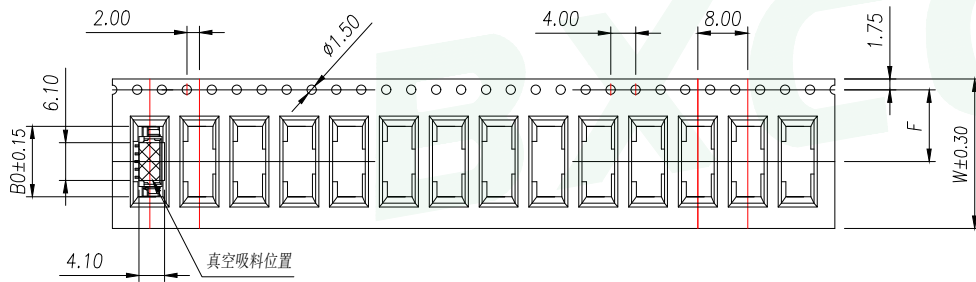

4



- NOTE:
- 1.10 SPROCKET HOLE PITCH CUMULATIVE TOLERANCE $\pm 0.2\text{mm}$.
 - 2.CARRIER CAMBER NOT TO EXCEED 1mm IN 100mm.
 - 3.ALL DIMENSIONS MEET EIA-481 REQUIREMENTS.
 - 4.MATERIAL: CLEAR ANTISTATIC PS, COLD SEALING.
 - 5.COMPONENT LOAD PER REEL: 1500 PCS.

5

PIN	NO.	B0	Dim W	Dim F	PCS/RELL	RELL/CARTON	PCS/CARTON
2	WF-1E125A2P	7.80	16	7.50	1500	14	21000
3	WF-1E125A3P	9.05					
4	WF-1E125A4P	10.30					
5	WF-1E125A5P	11.55	24	11.50	1500	10	15000
6	WF-1E125A6P	12.80					
7	WF-1E125A7P	14.05					
8	WF-1E125A8P	15.30					

GENERAL TOLERANCE		DONGGUAN BAOXUN PRECISION TECHNOLOGY CO., LTD				 	
DIM.	TOL.	TITLE: 线对板针座 MX1.25 立式贴片					
X		DWG. NO.: WF-1E125ANP					
X.X	± 0.30	DRAWN: MAX					
X.XX	± 0.25	CHECKED: ELLA					
X.XXX	± 0.15	PART NO.: WF-1E125ANP					
GENERAL	ANGLE: $\pm 3^\circ$	UNIT: mm	SCALE: none	SHEET: 1 of 1	DWG. SIZE: A4	LAYER: bxconn	APPROVED: WILL

A		B		C		D		E	
REV.	DESCRIPTION				ECN NO.	NAME	DATE		

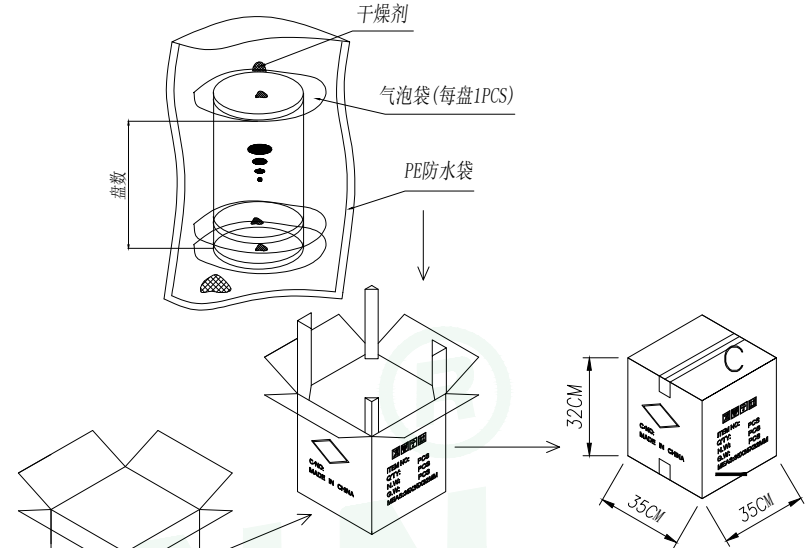
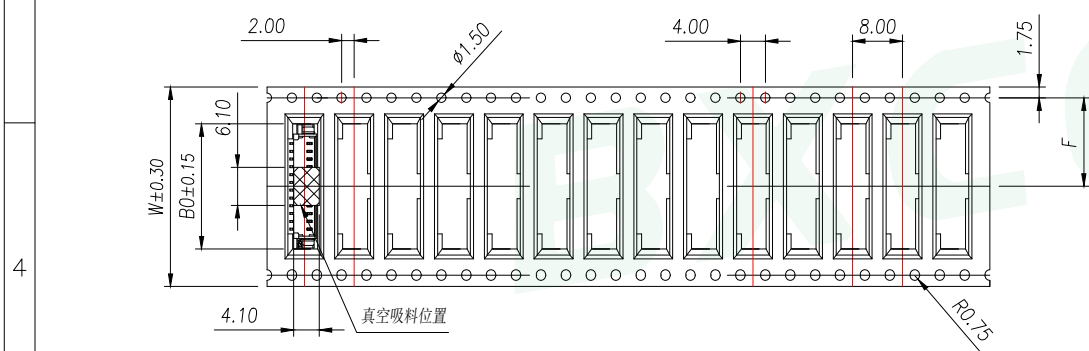
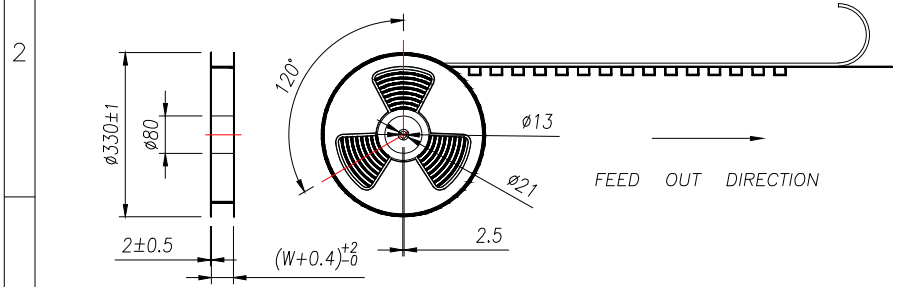
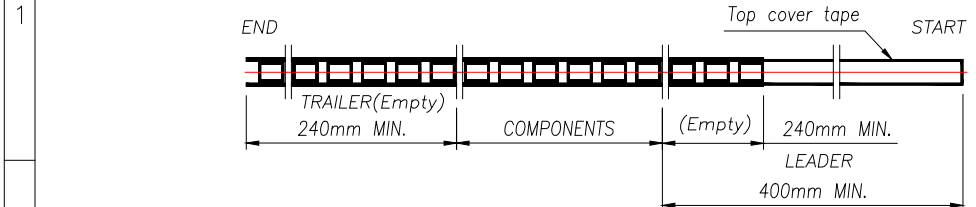

NOTE:
 1.10 SPROCKET HOLE PITCH CUMULATIVE TOLERANCE $\pm 0.2\text{mm}$.
 2.CARRIER CAMBER NOT TO EXCEED 1mm IN 100mm.
 3.ALL DIMENSIONS MEET EIA-481 REQUIREMENTS.
 4.MATERIAL: CLEAR ANTISTATIC PS, COLD SEALING.
 5.COMPONENT LOAD PER REEL: 1500 PCS.

PIN	NO.	B0	Dim W	Dim F	PCS/REEL	REEL/CARTON	PCS/CARTON
09	WF-1E125A9P	16.55	32	14.2	1500	8	12000
10	WF-1E125A10P	17.80					
11	WF-1E125A11P	19.05					
12	WF-1E125A12P	20.30					
13	WF-1E125A13P	21.55	44	20.2	1500	6	9000
14	WF-1E125A14P	22.80					
15	WF-1E125A15P	24.05					
16	WF-1E125A16P	25.30					

GENERAL TOLERANCE		DONGGUAN BAOXUN PRECISION TECHNOLOGY CO., LTD				
DIM.	TOL.	TITLE: 线对板针座 MX1.25 立式贴片				
X		DWG. NO.: WF-1E125ANP		DRAWN: MAX		
X.X	± 0.30	PART NO.: WF-1E125ANP		CHECKED: ELLA		
X.XX	± 0.25	UNIT: mm		SCALE: none	SHEET: 1 of 1	APPROVED: WILL
X.XXX	± 0.15	DWG. SIZE: A4		LAYER: bxconn		
GENERAL	ANGLE: $\pm 3^\circ$					

X-ON Electronics

Largest Supplier of Electrical and Electronic Components

Click to view similar products for [Headers & Wire Housings](#) category:

Click to view products by [BXCONN](#) manufacturer:

Other Similar products are found below :

[0015917161](#) [0022155065](#) [57102-F02-18ULF](#) [58102-G61-06LF](#) [582553-1](#) [01.001.5753.1](#) [0050291907](#) [02.125.8002.8](#) [609-3404](#) [61062-3](#)
[CSU011177004](#) [622-0430](#) [622-3653LF](#) [63453-116](#) [636-1030](#) [636-1427](#) [636-3427](#) [636-4007](#) [641938-9](#) [65495-038](#) [65692-001LF](#) [65781-018](#)
[65781-047](#) [65817-010LF](#) [65817-015LF](#) [67095-007LF](#) [67601157](#) [68631-112](#) [699319-000](#) [70.362.1628.0](#) [70-4210](#) [70-4226B](#) [70-4853B](#) [707-](#)
[5028](#) [71.350.2428.0](#) [733-134](#) [733-162](#) [760-3052](#) [MHR-64-VUAL](#) [80.063.4001.1](#) [800-90-001-10-001000](#) [801-43-002-10-013000](#)
[801-43-006-10-002000](#) [803-43-024-10-001000](#) [803-93-012-10-001000](#) [8-1437020-4](#) [819-22-004-30-001101](#) [820-22-006-30-001101](#)
[820-22-008-30-001101](#) [821-22-002-10-001101](#)