

A

B

C

D

E

REV.	DESCRIPTION	ECN NO.	NAME	DATE

1

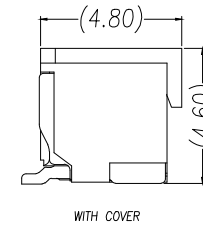
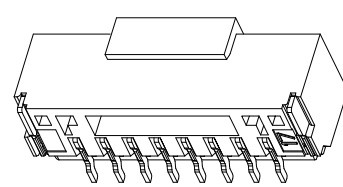
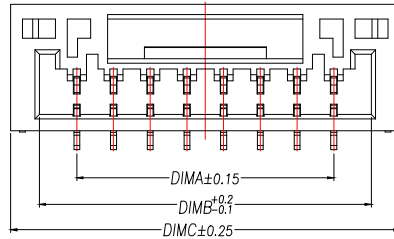

WITH COVER

NOTES:

1. Working temp: $-25^{\circ}\text{C} \sim 85^{\circ}\text{C}$.
2. Voltage rating: 50V AC/DC(rms)
3. Contact resistance: 40mΩ max.
4. Insulation resistance: 100MΩ min.
5. Current rating: 1A AV/DC
6. Withstanding Voltage: 500V AC/minute
7. Pin Retention Force: 0.5N min.
8. Housing material: LCP UL94-V0, Natural
9. Terminal mater: Brass,
plating Ni 40u" min , plating Tin 100u" min.
10. Solder tab material: Brass,
plating Ni 40u" min , plating Tin 100u" min.

2

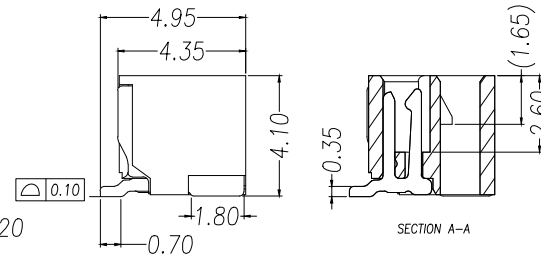
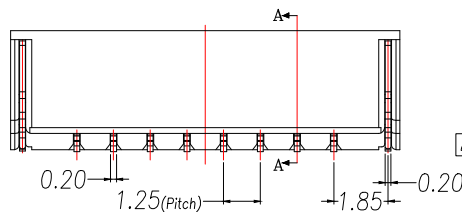

SECTION A-A

3

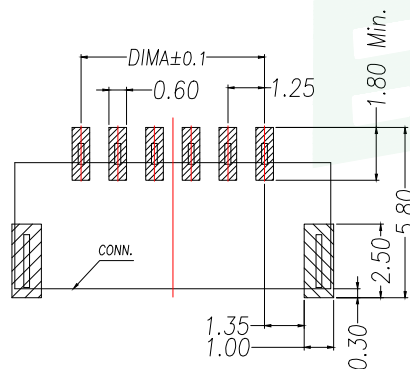

RECOMMENDED PCB LAYOUT TOP VIEW (TOLERANCE: ±0.05)

SMT SOLDER AREA

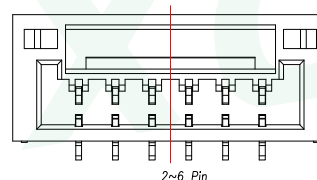

2~6 Pin

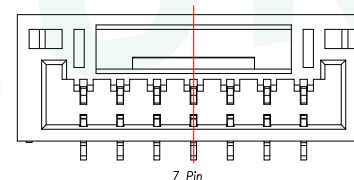

7 Pin

4

PIN	NO.	Dim A	Dim B	Dim C
2	XY-GH1.25-2A51	1.25	3.80	5.75
3	XY-GH1.25-3A51	2.50	5.05	7.00
4	XY-GH1.25-4A51	3.75	6.30	8.25
5	XY-GH1.25-5A51	5.00	7.55	9.50
6	XY-GH1.25-6A51	6.25	8.80	10.75
7	XY-GH1.25-7A51	7.50	10.05	12.00
8	XY-GH1.25-8A51	8.75	11.30	13.25
9	XY-GH1.25-N951	10.00	12.55	14.50
10	XY-GH1.25-10A51	11.25	13.80	15.75
11	XY-GH1.25-11A51	12.50	15.05	17.00
12	XY-GH1.25-12A51	13.75	16.30	18.25
13	XY-GH1.25-13A51	15.00	17.55	19.50
14	XY-GH1.25-14A51	16.25	18.80	20.75
15	XY-GH1.25-15A51	17.50	20.05	22.00
16	XY-GH1.25-16A51	18.75	21.30	23.25

5

GENERAL TOLERANCE	DONGGUAN BAOXUN PRECISION TECHNOLOGY CO., LTD					
DIM. TOL.	TITLE: 线对板针座 GH1.25 带扣 立式贴片					
X ±0.30	DWG. NO.: WF-1E125BNP		DRAWN: MAX			
X.X ±0.25	PART NO.: WF-1E125BNP		CHECKED: ELLA			
X.XX ±0.15	UNIT: mm		SCALE: none	SHEET: 1 of 1		APPROVED: WILL
X.XXX ±0.10	DWG. SIZE: A4		LAYER: bxconn			
GENERAL ANGLE: ±3°						

REV.	DESCRIPTION	ECN NO.	NAME	DATE

1

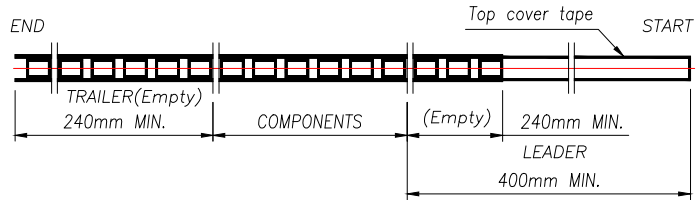

2

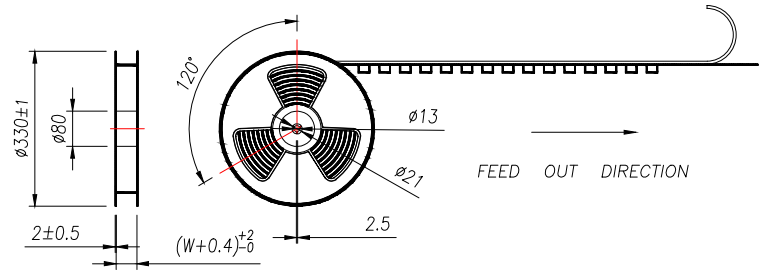

3

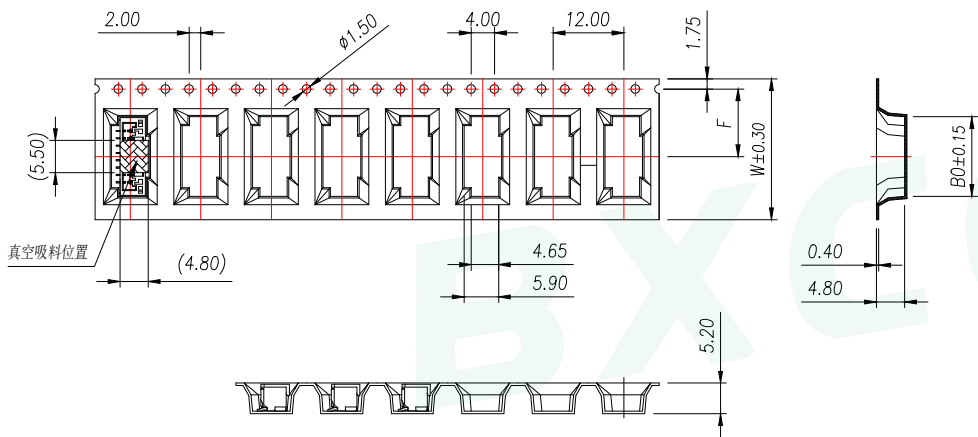

4

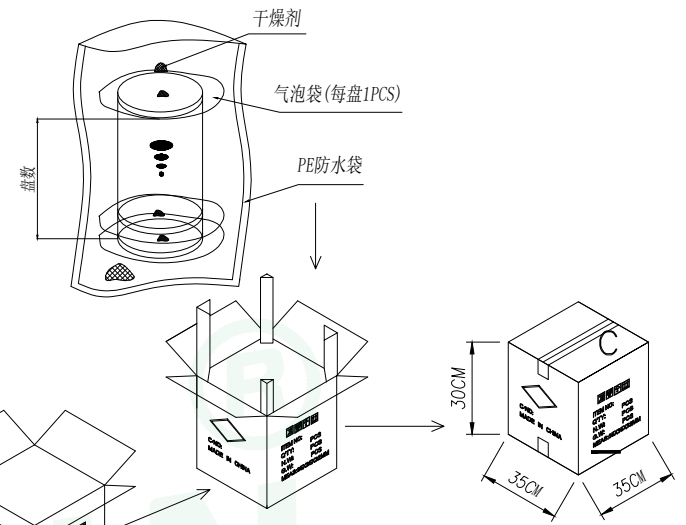

NOTE:
 1.10 SPROCKET HOLE PITCH CUMULATIVE TOLERANCE $\pm 0.2\text{mm}$.
 2.CARRIER CAMBER NOT TO EXCEED 1mm IN 100mm.
 3.ALL DIMENSIONS MEET EIA-481 REQUIREMENTS.
 4.MATERIAL: CLEAR ANTISTATIC PS, COLD SEALING.
 5.COMPONENT LOAD PER REEL: 1000 PCS.

5

PIN	NO.	B0	Dim W	Dim F	PCS/REEL	REEL/CARTON	PCS/CARTON
2	XY-GH1.25-2A51	6.05	16	7.50	1000	14	14000
3	XY-GH1.25-3A51	7.30					
4	XY-GH1.25-4A51	8.55					
5	XY-GH1.25-5A51	9.80	24	11.50	1000	10	10000
6	XY-GH1.25-6A51	11.05					
7	XY-GH1.25-7A51	12.30					
8	XY-GH1.25-8A51	13.55					
9	XY-GH1.25-9A51	14.80					

GENERAL TOLERANCE		DONGGUAN BAOXUN PRECISION TECHNOLOGY CO., LTD			
DIM.	TOL.	TITLE: 线对板针座 GH1.25 带扣 立式卧贴			
X		DWG. NO.: WF-1E125BNP		DRAWN: MAX	
X.X	± 0.30	PART NO.: WF-1E125BNP		CHECKED: ELLA	
X.XX	± 0.25	UNIT: mm		SCALE: none	
X.XXX	± 0.15	SHEET: 1 of 1		DWG. SIZE: A4	
GENERAL	ANGLE: $\pm 3^\circ$	LAYER: bxconn		APPROVED: WILL	

BXCONN[®]



REV.	DESCRIPTION	ECN NO.	NAME	DATE

1

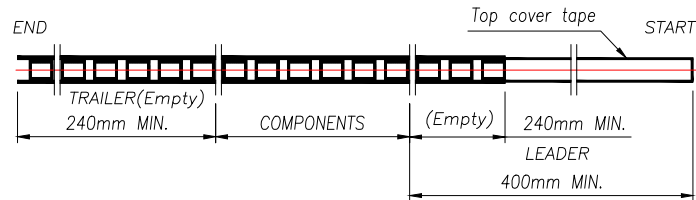

2

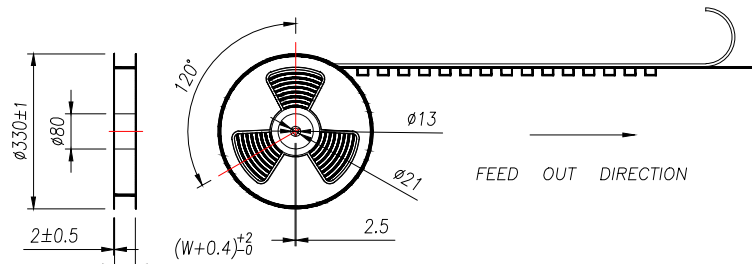

3

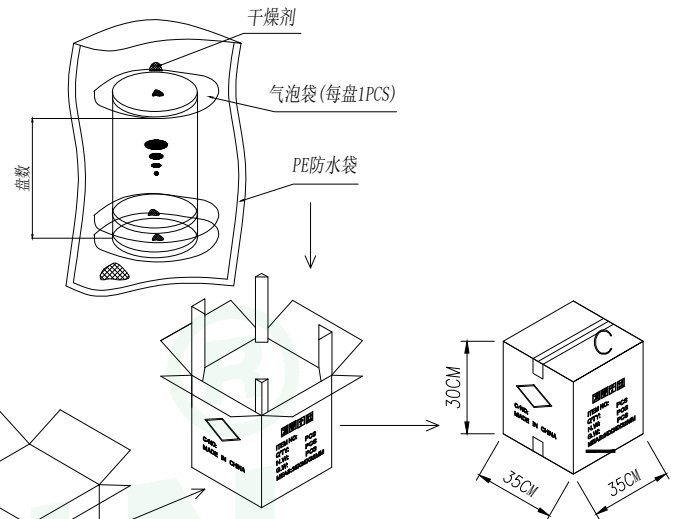
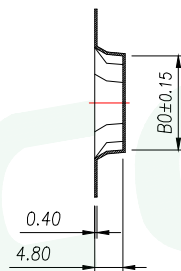
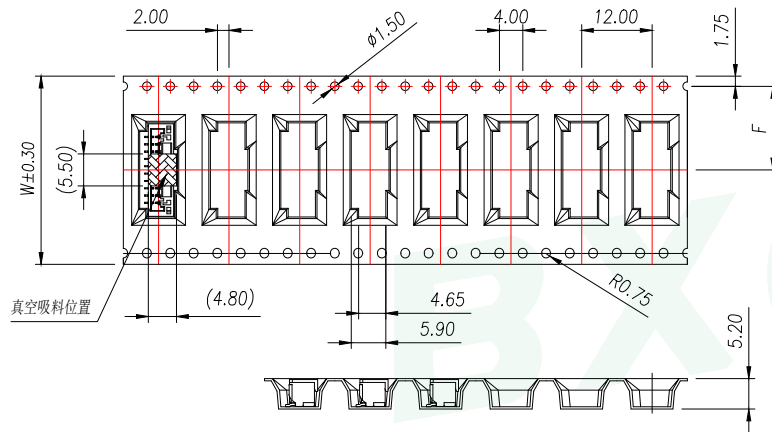

- NOTE:
- 1.10 SPROCKET HOLE PITCH CUMULATIVE TOLERANCE $\pm 0.2\text{mm}$.
 - 2.CARRIER CAMBER NOT TO EXCEED 1mm IN 100mm.
 - 3.ALL DIMENSIONS MEET EIA-481 REQUIREMENTS.
 - 4.MATERIAL: CLEAR ANTISTATIC PS, COLD SEALING.
 - 5.COMPONENT LOAD PER REEL: 1000 PCS.

5

PIN	NO.	B0	Dim W	Dim F	PCS/REEL	REEL/CARTON	PCS/CARTON
10	XY-GH1.25-10A51	16.05	32	14.2	1000	8	8000
11	XY-GH1.25-11A51	17.30					
12	XY-GH1.25-12A51	18.55					
13	XY-GH1.25-13A51	19.80					
14	XY-GH1.25-14A51	21.05	44	20.2	1000	6	6000
15	XY-GH1.25-15A51	22.30					
16	XY-GH1.25-16A51	23.55					

GENERAL TOLERANCE		DONGGUAN BAOXUN PRECISION TECHNOLOGY CO., LTD			
DIM. TOL.		TITLE: 线对板针座 GH1.25 带扣 立式贴片			
X		DWG. NO.: WF-1E125BNP		DRAWN: MAX	
X.X	± 0.30	PART NO.: WF-1E125BNP		CHECKED: ELLA	
X.XX	± 0.25	UNIT: mm		SCALE: none	
X.XXX	± 0.15	SHEET: 1 of 1		DWG. SIZE: A4	
GENERAL ANGLE:	$\pm 3^\circ$	LAYER: bxconn		APPROVED: WILL	



X-ON Electronics

Largest Supplier of Electrical and Electronic Components

Click to view similar products for [Headers & Wire Housings](#) category:

Click to view products by [BXCONN](#) manufacturer:

Other Similar products are found below :

[0015917161](#) [0022155065](#) [57102-F02-18ULF](#) [58102-G61-06LF](#) [582553-1](#) [01.001.5753.1](#) [0050291907](#) [02.125.8002.8](#) [609-3404](#) [61062-3](#)
[CSU011177004](#) [622-0430](#) [622-3653LF](#) [63453-116](#) [636-1030](#) [636-1427](#) [636-3427](#) [636-4007](#) [641938-9](#) [65495-038](#) [65692-001LF](#) [65781-018](#)
[65781-047](#) [65817-010LF](#) [65817-015LF](#) [67095-007LF](#) [67601157](#) [68631-112](#) [699319-000](#) [70.362.1628.0](#) [70-4210](#) [70-4226B](#) [70-4853B](#) [707-](#)
[5028](#) [71.350.2428.0](#) [733-134](#) [733-162](#) [760-3052](#) [MHR-64-VUAL](#) [80.063.4001.1](#) [800-90-001-10-001000](#) [801-43-002-10-013000](#)
[801-43-006-10-002000](#) [803-43-024-10-001000](#) [803-93-012-10-001000](#) [8-1437020-4](#) [819-22-004-30-001101](#) [820-22-006-30-001101](#)
[820-22-008-30-001101](#) [821-22-002-10-001101](#)