

REV.	DESCRIPTION	ECN NO.	NAME	DATE

- NOTES:
- Working temp:-25°C~85°C.
 - Voltage rating:100V AV/DC(rms)
 - Contact resistance:20mΩ max.
 - Insulation resistance:1000MΩ min.
 - Current rating:2A AV/DC
 - Withstanding Voltage:800V AC/minute
 - Pin Retention Force:15N min.
 - Housing material:LCP UL94-V0,Natural
 - Terminal materl:Brass,
plating Ni 50u" min , plating Tin 100u"min.
 - Solder tab material:Brass,
plating Ni 50u" min , plating Tin 100u"min.

PIN	NO.	Dim A	Dim B	Dim C
2	WF-1E200A2P	2.00	4.80	7.95
3	WF-1E200A3P	4.00	6.80	9.95
4	WF-1E200A4P	6.00	8.80	11.95
5	WF-1E200A5P	8.00	10.80	13.95
6	WF-1E200A6P	10.00	12.80	15.95
7	WF-1E200A7P	12.00	14.80	17.95
8	WF-1E200A8P	14.00	16.80	19.95
9	WF-1E200A9P	16.00	18.80	21.95
10	WF-1E200A10P	18.00	20.80	23.95
11	WF-1E200A11P	20.00	22.80	25.95
12	WF-1E200A12P	22.00	24.80	27.95
13	WF-1E200A13P	24.00	26.80	29.95
14	WF-1E200A14P	26.00	28.80	31.95
15	WF-1E200A15P	28.00	30.80	33.95
16	WF-1E200A16P	30.00	32.80	35.95

GENERAL TOLERANCE	DONGGUAN BAOXUN PRECISION TECHNOLOGY CO., LTD				
DIM. TOL.	TITLE: 线对板针座 PH2.0 立式贴片				
X	±0.30	DWG. NO.: WF-1E200ANP			DRAWN: MAX
X.X	±0.25	PART NO.: WF-1E200ANP			CHECKED: ELLA
X.XX	±0.15	UNIT: mm	SCALE: none	SHEET: 1 of 1	APPROVED: WILL
X.XXX	±0.10	DWG. SIZE: A4	LAYER: bxconn		
GENERAL ANGLE: ±3°					



REV.	DESCRIPTION	ECN NO.	NAME	DATE

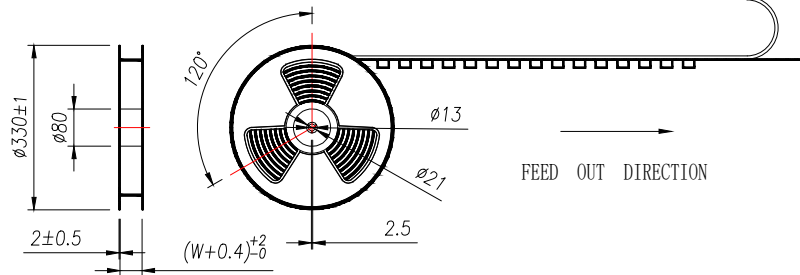
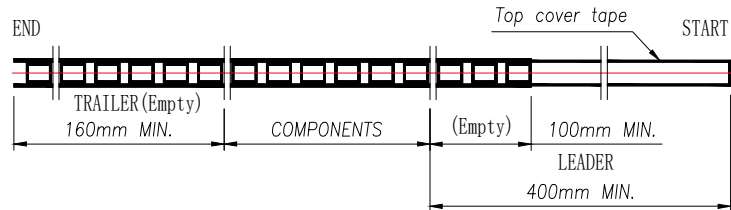

FEED OUT DIRECTION

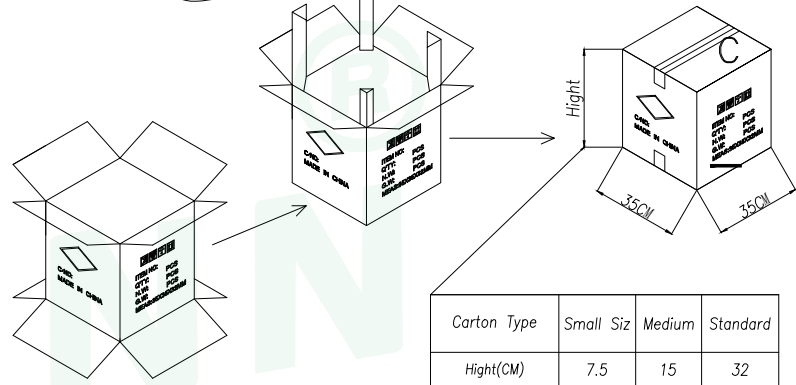
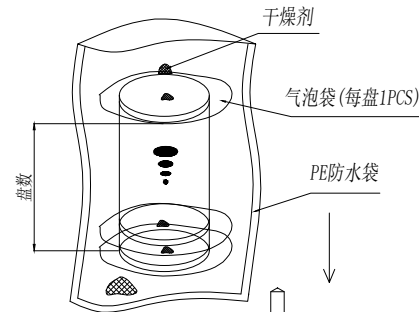
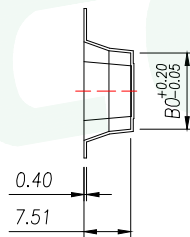
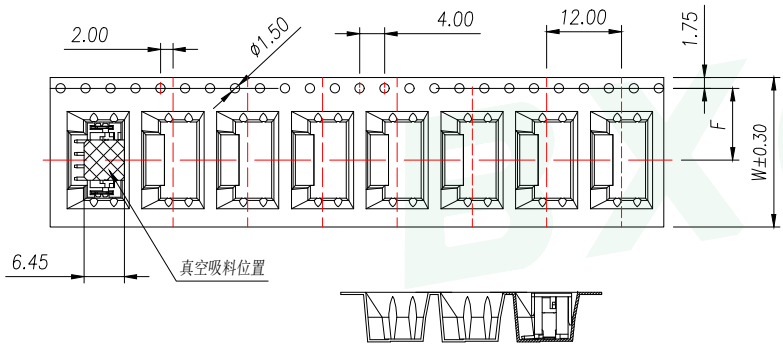

Carton Type	Small Siz	Medium	Standard
Hight(CM)	7.5	15	32

- NOTE:
- 1.10 SPROCKET HOLE PITCH CUMULATIVE TOLERANCE $\pm 0.2\text{mm}$.
 - 2.CARRIER CAMBER NOT TO EXCEED 1mm IN 100mm.
 - 3.ALL DIMENSIONS MEET EIA-481 REQUIREMENTS.
 - 4.MATERIAL: CLEAR ANTISTATIC PS, COLD SEALING.
 - 5.THICKNESS: $0.40 \pm 0.05\text{mm}$.
 - 6.PACKING LENGHT PER REEL: 8.8 METERS.
 - 7.COMPONENT LOAD PER REEL: 700 PCS.

PIN	NO.	Dim BO	Dim W	Dim F	PCS/RELL	RELL/CARTON	PCS/CARTON
2	WF-1E200A2P	8.20	16	7.5	700	14	9800
3	WF-1E200A3P	10.20					
4	WF-1E200A4P	12.20	24	11.50	700	10	7000
5	WF-1E200A5P	14.20					

GENERAL TOLERANCE	DONGGUAN BAOXUN PRECISION TECHNOLOGY CO., LTD				
DIM. TOL.	TITLE: 线对板针座 PH2.0 立式贴片				
X	DWG. NO.: WF-1E200ANP				
X.X	DRAWN: MAX				
X.XX	PART NO.: WF-1E200ANP				
X.XXX	CHECKED: ELLA				
GENERAL ANGLE: $\pm 3^\circ$	APPROVED: WILL				
	UNIT: mm	SCALE: none	SHEET: 1 of 1	DWG. SIZE: A4	LAYER: bxconn

BXCONN[®]



REV.	DESCRIPTION	ECN NO.	NAME	DATE

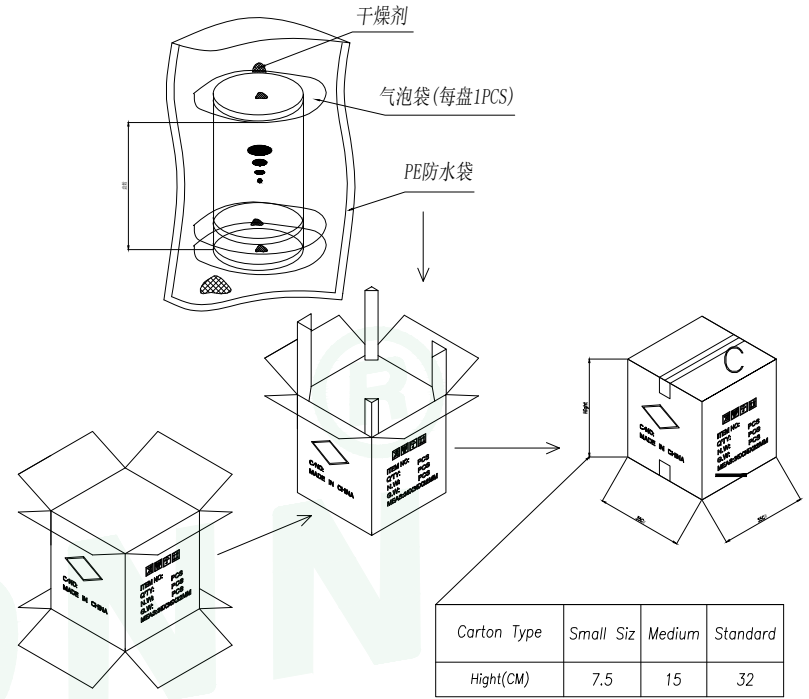
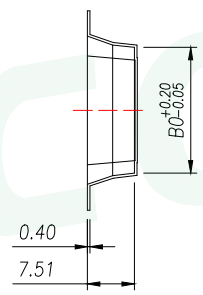
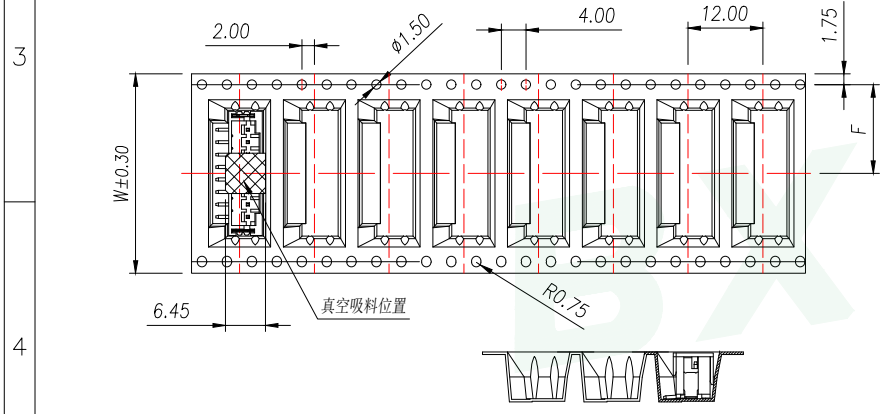
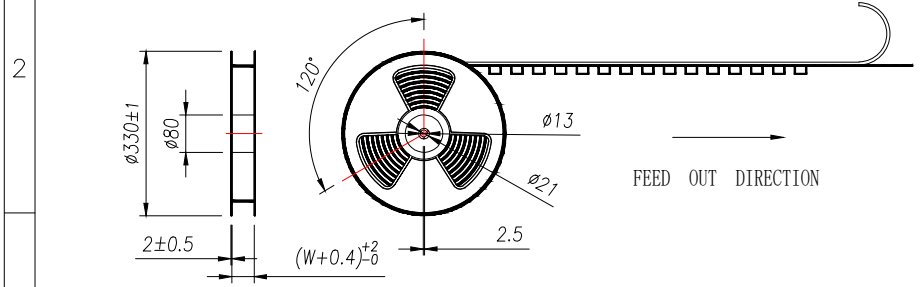
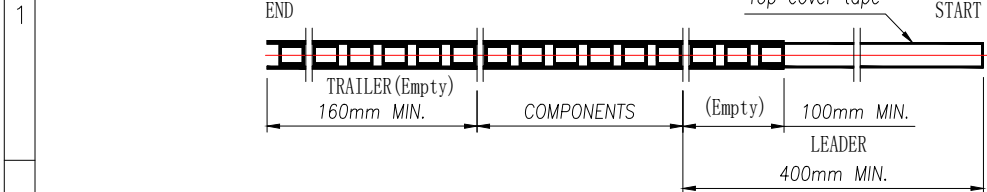

Carton Type	Small Siz	Medium	Standard
Height(CM)	7.5	15	32

- NOTE:
- 1.10 SPROCKET HOLE PITCH CUMULATIVE TOLERANCE $\pm 0.2\text{mm}$.
 - 2.CARRIER CAMBER NOT TO EXCEED 1mm IN 100mm.
 - 3.ALL DIMENSIONS MEET EIA-481 REQUIREMENTS.
 - 4.MATERIAL: CLEAR ANTISTATIC PS, COLD SEALING.
 - 5.THICKNESS: $0.40 \pm 0.05\text{mm}$.
 - 6.PACKING LENGHT PER REEL: 8.8 METERS.
 - 7.COMPONENT LOAD PER REEL: 700 PCS.

PIN	NO.	Dim BO	Dim W	Dim F	PCS/RELL	RELL/CARTON	PCS/CARTON
6	WF-1E200A6P	16.20	32	14.2	700	8	5600
7	WF-1E200A7P	18.20					
8	WF-1E200A8P	20.20					
9	WF-1E200A9P	22.20					
10	WF-1E200A10P	24.20	44	20.2	700	6	4200
11	WF-1E200A11P	26.20					
12	WF-1E200A12P	28.20					
13	WF-1E200A13P	30.20					
14	WF-1E200A14P	32.20	56	26.2	700	5	3500
15	WF-1E200A15P	34.20					
16	WF-1E200A16P	36.20					

GENERAL TOLERANCE		DONGGUAN BAOXUN PRECISION TECHNOLOGY CO., LTD			
DIM.	TOL.	TITLE: 线对板针座 PH2.0 立式贴片			
X		DWG. NO.: WF-1E200ANP		DRAWN: MAX	
X.X	± 0.30	PART NO.: WF-1E200ANP		CHECKED: ELLA	
X.XX	± 0.25	UNIT: mm		APPROVED: WILL	
X.XXX	± 0.15	SCALE: none	SHEET: 1 of 1	DWG. SIZE: A4	LAYER: bxconn
GENERAL ANGLE:	$\pm 3^\circ$				



X-ON Electronics

Largest Supplier of Electrical and Electronic Components

Click to view similar products for [Headers & Wire Housings](#) category:

Click to view products by [BXCONN](#) manufacturer:

Other Similar products are found below :

[0015917161](#) [0022155065](#) [57102-F02-18ULF](#) [58102-G61-06LF](#) [582553-1](#) [01.001.5753.1](#) [0050291907](#) [02.125.8002.8](#) [609-3404](#) [61062-3](#)
[CSU011177004](#) [622-0430](#) [622-3653LF](#) [63453-116](#) [636-1030](#) [636-1427](#) [636-3427](#) [636-4007](#) [641938-9](#) [65495-038](#) [65692-001LF](#) [65781-018](#)
[65781-047](#) [65817-010LF](#) [65817-015LF](#) [67095-007LF](#) [67601157](#) [68631-112](#) [699319-000](#) [70.362.1628.0](#) [70-4210](#) [70-4226B](#) [70-4853B](#) [707-](#)
[5028](#) [71.350.2428.0](#) [733-134](#) [733-162](#) [760-3052](#) [MHR-64-VUAL](#) [80.063.4001.1](#) [800-90-001-10-001000](#) [801-43-002-10-013000](#)
[801-43-006-10-002000](#) [803-43-024-10-001000](#) [803-93-012-10-001000](#) [8-1437020-4](#) [819-22-004-30-001101](#) [820-22-006-30-001101](#)
[820-22-008-30-001101](#) [821-22-002-10-001101](#)