

A		B		C		D		E	
REV.	DESCRIPTION				ECN NO.	NAME	DATE		

1  
2  
3  
4  
5

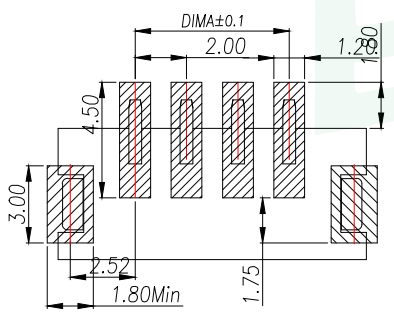

RECOMMENDED PCB LAYOUT TOP VIEW (TOLERANCE:±0.05)  
 SMT SOLDER AREA

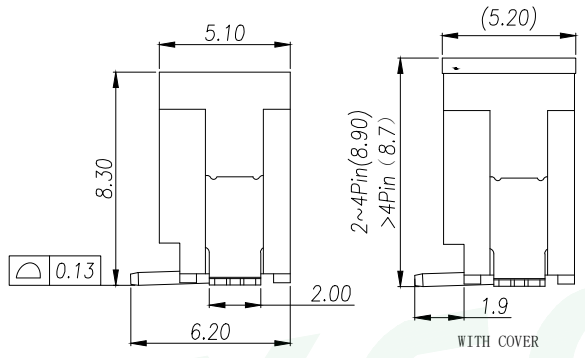
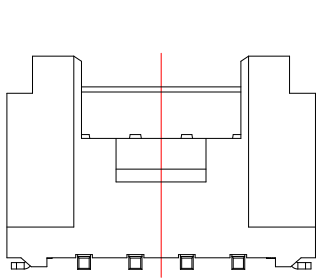
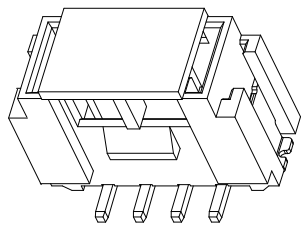
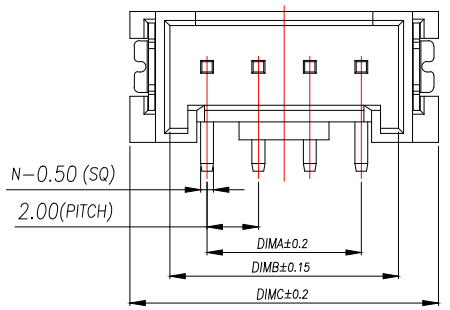
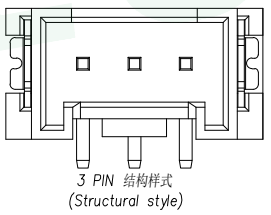
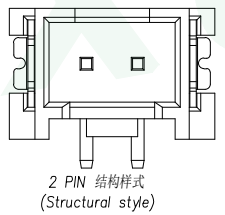

NOTES:

- Working temp: -25°C~85°C.
- Voltage rating: 100V AV/DC(rms)
- Contact resistance: 20mΩ max.
- Insulation resistance: 1000MΩ min.
- Current rating: 2A AV/DC
- Withstanding Voltage: 800V AC/minute
- Pin Retention Force: 15N min.
- Housing material: LCP UL94-V0, Natural
- Terminal materl: Brass,  
plating Ni 50u" min , plating Tin 100u"min.
- Solder tab material: Brass,  
plating Ni 50u" min , plating Tin 100u"min.

PIN	NO.	Dim A	Dim B	Dim C
2	WF-1E200B2P	2.00	4.90	8.00
3	WF-1E200B3P	4.00	6.90	10.00
4	WF-1E200B4P	6.00	8.90	12.00
5	WF-1E200B5P	8.00	10.90	14.00
6	WF-1E200B6P	10.00	12.90	16.00
7	WF-1E200B7P	12.00	14.90	18.00
8	WF-1E200B8P	14.00	16.90	20.00
9	WF-1E200B9P	16.00	18.90	22.00
10	WF-1E200B10P	18.00	20.90	24.00
11	WF-1E200B11P	20.00	22.90	26.00
12	WF-1E200B12P	22.00	24.90	28.00
13	WF-1E200B13P	24.00	26.90	30.00
14	WF-1E200B14P	26.00	28.90	32.00
15	WF-1E200B15P	28.00	30.90	34.00
16	WF-1E200B16P	30.00	32.90	36.00

GENERAL TOLERANCE		DONGGUAN BAOXUN PRECISION TECHNOLOGY CO., LTD			
DIM.	TOL.	TITLE: 线对板插座 HY2.0 带扣 立式贴片			
X		DWG. NO.: WF-1E200BNP		DRAWN: MAX	
X.X	±0.30	PART NO.: WF-1E200BNP		CHECKED: ELLA	
X.XX	±0.25	UNIT: mm		APPROVED: WILL	
X.XXX	±0.15	SCALE: none	SHEET: 1 of 1	DWG. SIZE: A4	LAYER: bxconn
GENERAL ANGLE:	±3°				



REV.	DESCRIPTION	ECN NO.	NAME	DATE

1

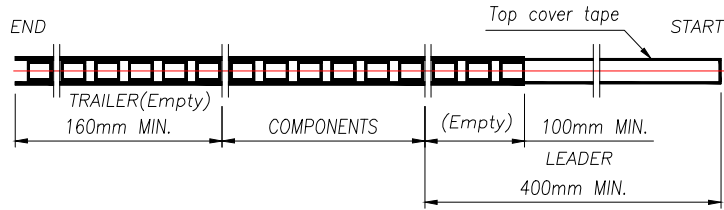

2

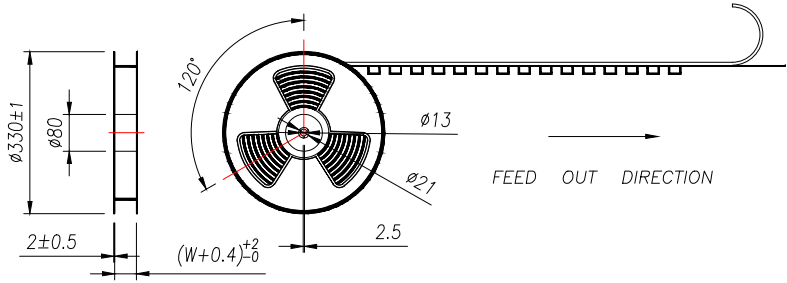

3

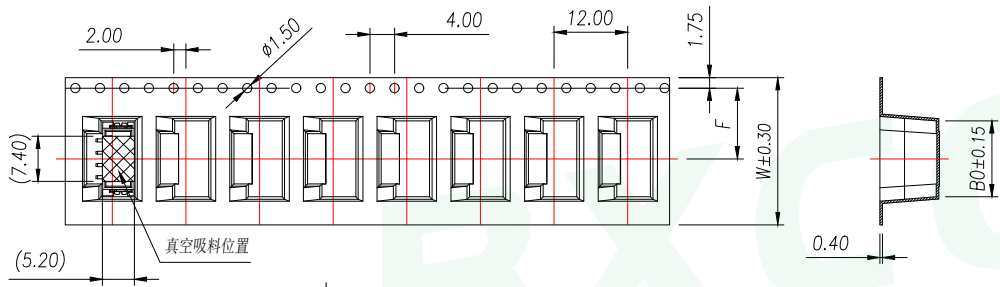

4

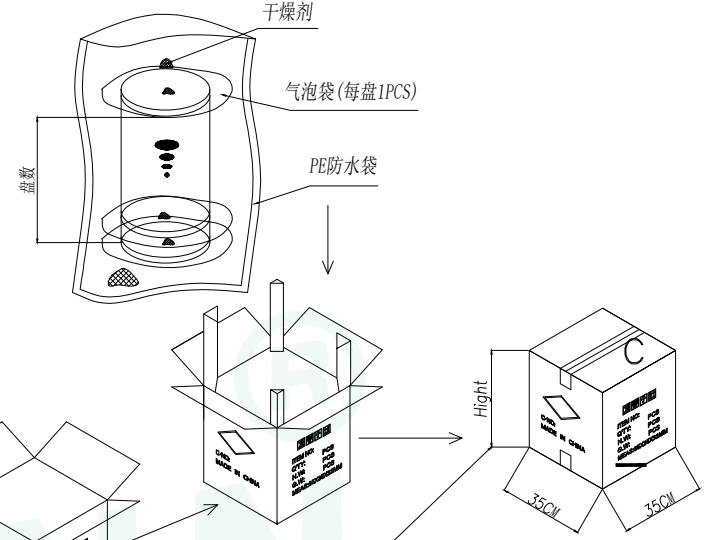
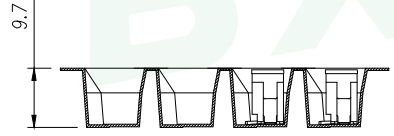



Carton Type	Small Siz	Medium	Standard
Hight(CM)	7.5	15	32

- NOTE:
- 1.10 SPROCKET HOLE PITCH CUMULATIVE TOLERANCE  $\pm 0.2\text{mm}$ .
  - 2.CARRIER CAMBER NOT TO EXCEED 1mm IN 100mm.
  - 3.ALL DIMENSIONS MEET EIA-481 REQUIREMENTS.
  - 4.MATRIAL: CLEAR ANTISTATIC PS, COLD SEALING.
  - 5.THICKNESS:  $0.40 \pm 0.05\text{mm}$ .
  - 6.PACKING LENGHT PER REEL: 7.6 METERS.
  - 7.COMPONENT LOAD PER REEL: 600 PCS.

5

PIN	NO.	Dim B0	Dim W	Dim F	PCS/RELL	RELL/CARTON	PCS/CARTON
2	WF-1E200B2P	8.40	24	11.50	600	10	6000
3	WF-1E200B3P	10.40					
4	WF-1E200B4P	12.40					
5	WF-1E200B5P	14.40					
6	WF-1E200B6P	16.40					

GENERAL TOLERANCE		DONGGUAN BAOXUN PRECISION TECHNOLOGY CO., LTD				 
DIM. TOL.		TITLE: 线对板针座 HY2.0 带扣 立式贴片				
X $\pm 0.30$		DWG. NO.: WF-1E200BNP		DRAWN: MAX		
X.X $\pm 0.25$		PART NO.: WF-1E200BNP		CHECKED: ELLA		
X.XX $\pm 0.15$		UNIT: mm		APPROVED: WILL		
X.XXX $\pm 0.15$		SCALE: none		SHEET: 1 of 1		
GENERAL ANGLE: $\pm 3^\circ$		DWG. SIZE: A4		LAYER: bxconn		

REV.	DESCRIPTION	ECN NO.	NAME	DATE

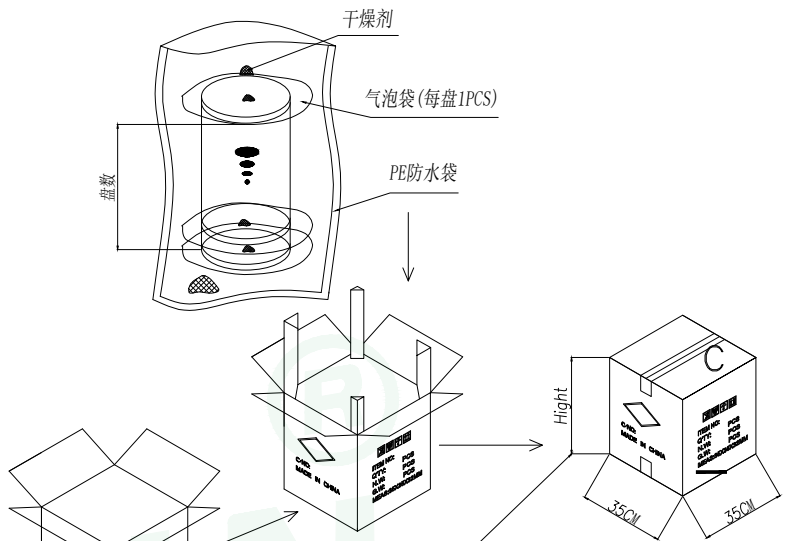
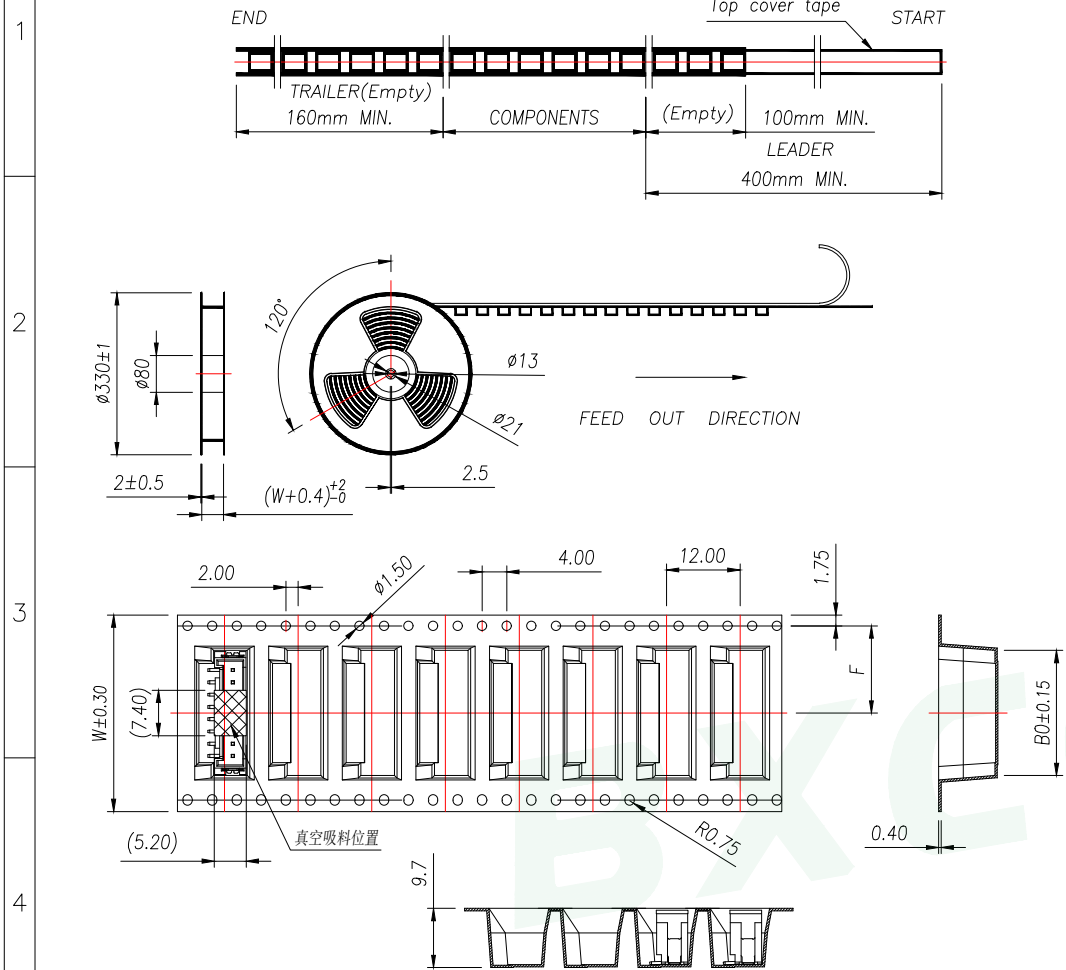

Carton Type	Small Siz	Medium	Standard
Hight(CM)	7.5	15	32

- NOTE:
- 1.10 SPROCKET HOLE PITCH CUMULATIVE TOLERANCE  $\pm 0.2\text{mm}$ .
  - 2.CARRIER CAMBER NOT TO EXCEED 1mm IN 100mm.
  - 3.ALL DIMENSIONS MEET EIA-481 REQUIREMENTS.
  - 4.MATERIAL: CLEAR ANTISTATIC PS, COLD SEALING.
  - 5.THICKNESS:  $0.40 \pm 0.05\text{mm}$ .
  - 6.PACKING LENGHT PER REEL: 7.6 METERS.
  - 7.COMPONENT LOAD PER REEL: 600 PCS.

PIN	NO.	Dim B0	Dim W	Dim F	PCS/RELL	RELL/CARTON	PCS/CARTON
7	WF-1E200B7P	18.40	32	14.2	600	8	4800
8	WF-1E200B8P	20.40					
9	WF-1E200B9P	22.40					
10	WF-1E200B10P	24.40	44	20.2	600	6	3600
11	WF-1E200B11P	26.40					
12	WF-1E200B12P	28.40					
13	WF-1E200B13P	30.40					
14	WF-1E200B14P	32.40	56	26.2	600	5	3000
15	WF-1E200B15P	34.40					
16	WF-1E200B16P	36.40					

GENERAL TOLERANCE		DONGGUAN BAOXUN PRECISION TECHNOLOGY CO., LTD			
DIM.	TOL.	TITLE: 线对板针座 HY2.0 带扣 立式贴片			
X		DWG. NO.: WF-1E200BNP		DRAWN: MAX	
X.X	$\pm 0.30$	PART NO.: WF-1E200BNP		CHECKED: ELLA	
X.XX	$\pm 0.25$	UNIT: mm		APPROVED: WILL	
X.XXX	$\pm 0.15$	SCALE: none	SHEET: 1 of 1	DWG. SIZE: A4	LAYER: bxconn
GENERAL ANGLE:	$\pm 3^\circ$				



## X-ON Electronics

Largest Supplier of Electrical and Electronic Components

*Click to view similar products for [Headers & Wire Housings](#) category:*

*Click to view products by [BXCONN](#) manufacturer:*

Other Similar products are found below :

[0015917161](#) [0022155065](#) [57102-F02-18ULF](#) [58102-G61-06LF](#) [582553-1](#) [01.001.5753.1](#) [0050291907](#) [02.125.8002.8](#) [609-3404](#) [61062-3](#)  
[CSU011177004](#) [622-0430](#) [622-3653LF](#) [63453-116](#) [636-1030](#) [636-1427](#) [636-3427](#) [636-4007](#) [641938-9](#) [65495-038](#) [65692-001LF](#) [65781-018](#)  
[65781-047](#) [65817-010LF](#) [65817-015LF](#) [67095-007LF](#) [67601157](#) [68631-112](#) [699319-000](#) [70.362.1628.0](#) [70-4210](#) [70-4226B](#) [70-4853B](#) [707-](#)  
[5028](#) [71.350.2428.0](#) [733-134](#) [733-162](#) [760-3052](#) [MHR-64-VUAL](#) [80.063.4001.1](#) [800-90-001-10-001000](#) [801-43-002-10-013000](#)  
[801-43-006-10-002000](#) [803-43-024-10-001000](#) [803-93-012-10-001000](#) [8-1437020-4](#) [819-22-004-30-001101](#) [820-22-006-30-001101](#)  
[820-22-008-30-001101](#) [821-22-002-10-001101](#)