

REV.	DESCRIPTION	ECN NO.	NAME	DATE

1  
  
2  
  
3  
  
4  
  
5

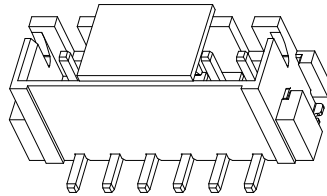
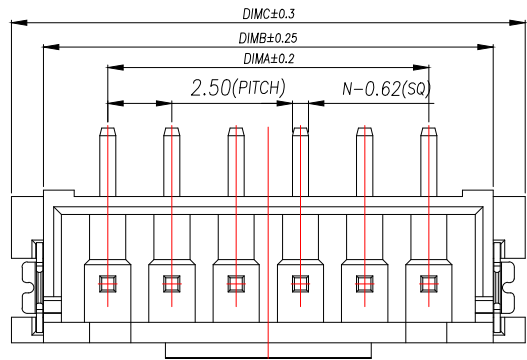

**NOTES:**

1. Working temp: -25°C~85°C.
2. Voltage rating: 250V AV/DC(rms)
3. Contact resistance: 20mΩ max.
4. Insulation resistance: 1000MΩ min.
5. Current rating: 3A AV/DC
6. Withstanding Voltage: 1000V AC/minute
7. Pin Retention Force: 15N min.
8. Housing material: LCP UL94-V0, Natural
9. Terminal materl: Brass,  
plating Ni 50u" min , plating Tin 100u"min.
10. Solder tab material: Brass,  
plating Ni 50u" min , plating Tin 100u"min.

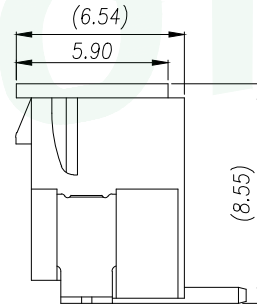
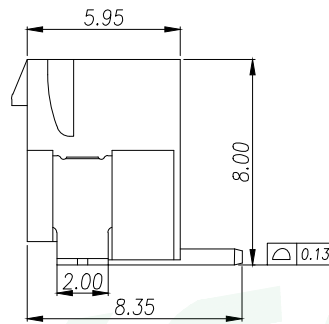
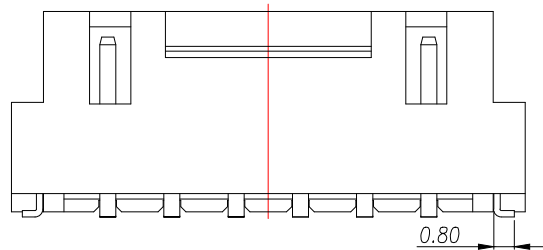

WITH COVER

PIN	NO.	Dim A	Dim B	Dim C
2	WF-1E254B2P	2.50	7.50	10.00
3	WF-1E254B3P	5.00	10.00	12.50
4	WF-1E254B4P	7.50	12.50	15.00
5	WF-1E254B5P	10.00	15.00	17.50
6	WF-1E254B6P	12.50	17.50	20.00
7	WF-1E254B7P	15.00	20.00	22.50
8	WF-1E254B8P	17.50	22.50	25.00
9	WF-1E254B9P	20.00	25.00	27.50
10	WF-1E254B10P	22.50	27.50	30.00
11	WF-1E254B11P	25.00	30.00	32.50
12	WF-1E254B12P	27.50	32.50	35.00
13	WF-1E254B13P	30.00	35.00	37.50
14	WF-1E254B14P	32.50	37.50	40.00
15	WF-1E254B15P	35.00	40.00	42.50
16	WF-1E254B16P	37.50	42.50	45.00

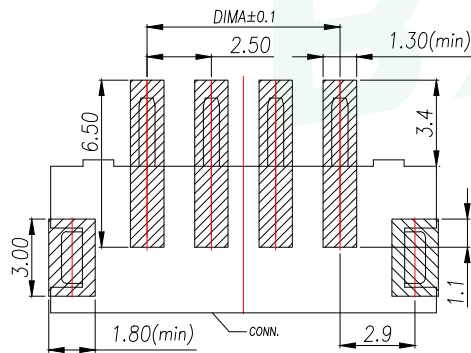

RECOMMENDED PCB LAYOUT TOP VIEW (TOLERANCE:±0.05)

SMT SOLDER AREA

GENERAL TOLERANCE		DONGGUAN BAOXUN PRECISION TECHNOLOGY CO., LTD			
DIM.	TOL.	TITLE: 线对板针座 XHB2.54 带扣 立式贴片			
X		DWG. NO.: WF-1E254BNP		DRAWN: MAX	
X.X	±0.30	PART NO.: WF-1E254BNP		CHECKED: ELLA	
X.XX	±0.25	UNIT: mm		APPROVED: WILL	
X.XXX	±0.15	SCALE: none	SHEET: 1 of 1	DWG. SIZE: A4	LAYER: bxconn
GENERAL ANGLE: ±3°					

**BXCONN**<sup>®</sup>



REV.	DESCRIPTION	ECN NO.	NAME	DATE

1

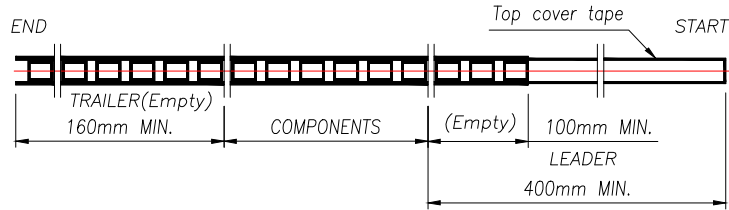

2

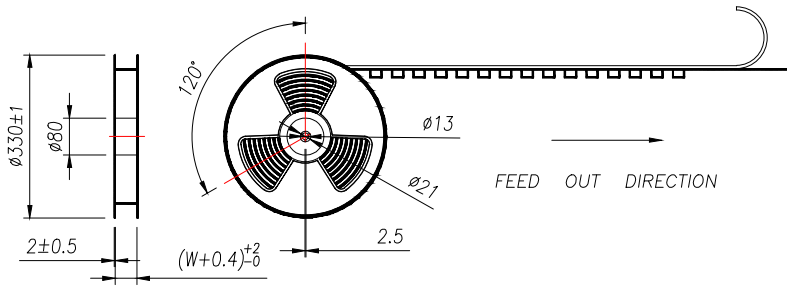

3

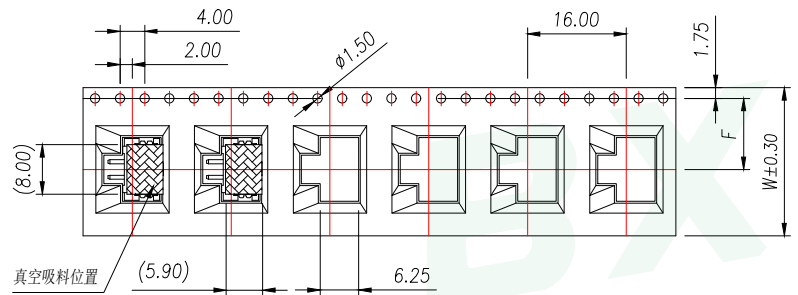

4

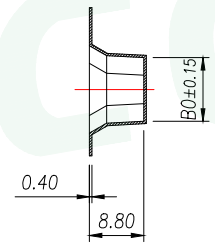

5

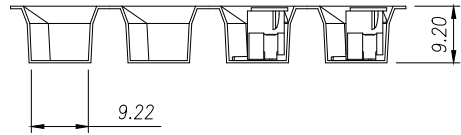

PIN	NO.	Dim B0	Dim W	Dim F	PCS/RELL	RELL/CARTON	PCS/CARTON
2	WF-1E254B2P	10.30	24.00	11.50	500	10	5000
3	WF-1E254B3P	12.80					
4	WF-1E254B4P	15.30					

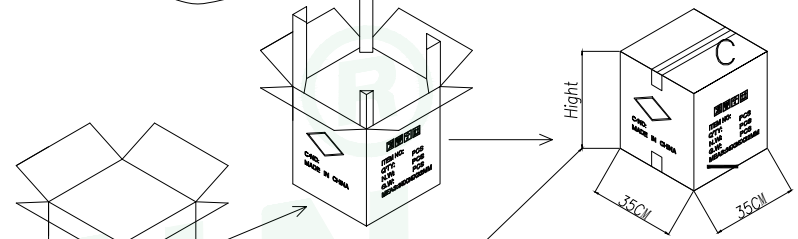
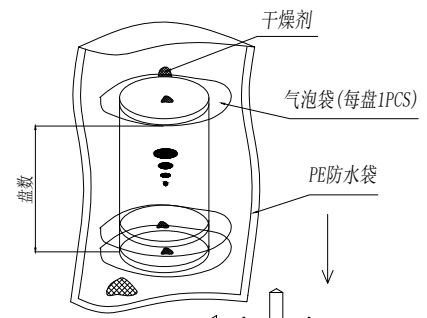

Carton Type	Small Siz	Medium	Standard
Height(CM)	7.5	15	32

- NOTE:
- 1.10 SPROCKET HOLE PITCH CUMULATIVE TOLERANCE ±0.2mm.
  - 2.CARRIER CAMBER NOT TO EXCEED 1mm IN 100mm.
  - 3.ALL DIMENSIONS MEET EIA-481 REQUIREMENTS.
  - 4.MATERIAL: CLEAR ANTISTATIC PS, GOLD SEALING.
  - 5.THICKNESS: 0.40±0.05mm.
  - 6.PACKING LENGTH PER REEL: 8.4 METERS.
  - 7.COMPONENT LOAD PER REEL: 500 PCS.

GENERAL TOLERANCE	DONGGUAN BAOXUN PRECISION TECHNOLOGY CO., LTD				
DIM. TOL.	TITLE: 线对板针座 XHB2.54 带扣 立式贴片				
X ±0.30	DWG. NO.: WF-1E254BNP		DRAWN: MAX		
X.X ±0.25	PART NO.: WF-1E254BNP		CHECKED: ELLA		
X.XX ±0.15	UNIT: mm	SCALE: none	SHEET: 1 of 1	DWG. SIZE: A4	LAYER: bxconn
X.XXX ±0.15	APPROVED: WILL				
GENERAL ANGLE: ±3°					



REV.	DESCRIPTION	ECN NO.	NAME	DATE

1

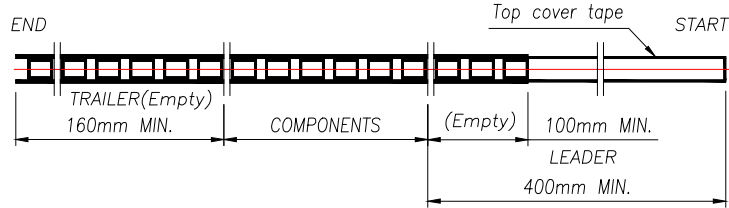

2

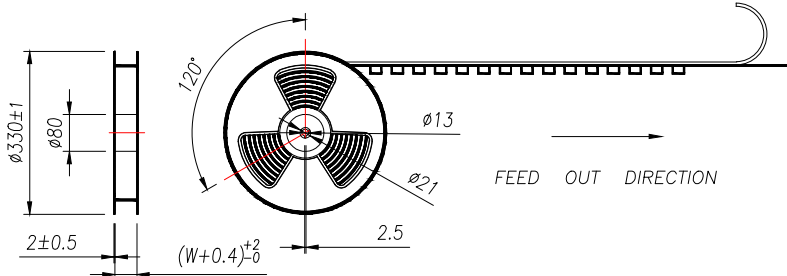

3

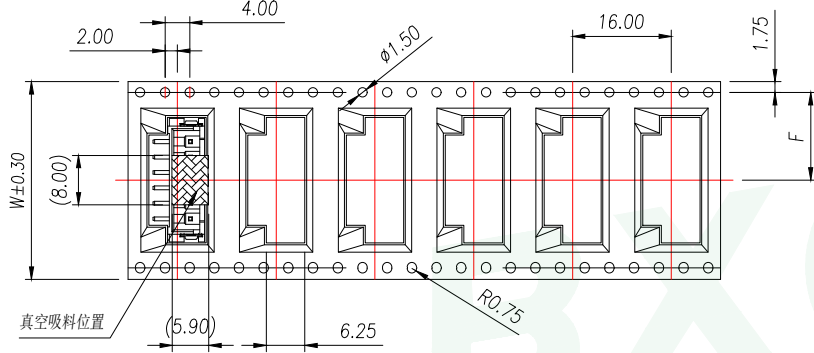

4

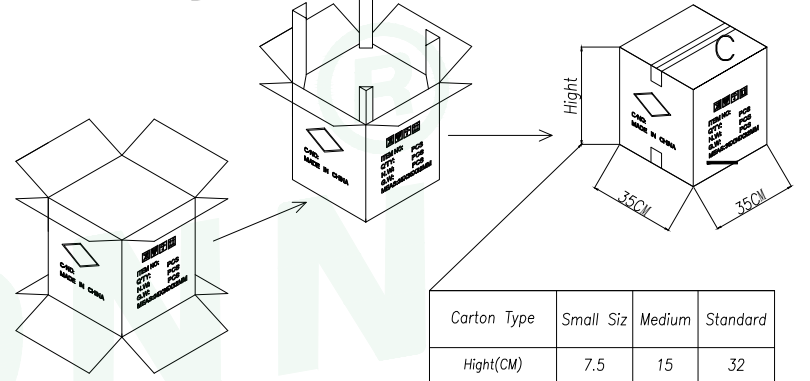
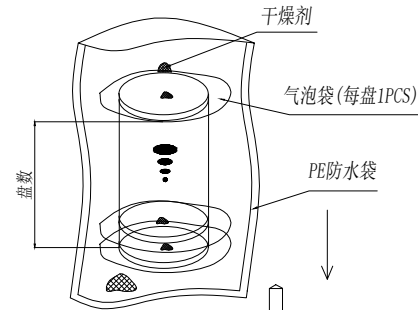
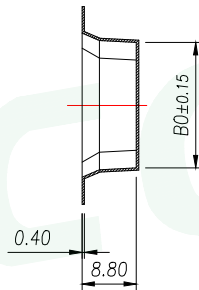
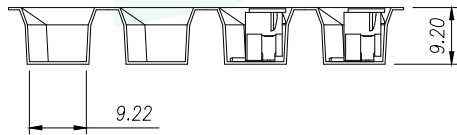

- NOTE:
- 1.10 SPROCKET HOLE PITCH CUMULATIVE TOLERANCE  $\pm 0.2\text{mm}$ .
  - 2.CARRIER CAMBER NOT TO EXCEED 1mm IN 100mm.
  - 3.ALL DIMENSIONS MEET EIA-481 REQUIREMENTS.
  - 4.MATERIAL: CLEAR ANTISTATIC PS, COLD SEALING.
  - 5.THICKNESS:  $0.40 \pm 0.05\text{mm}$ .
  - 6.PACKING LENGTH PER REEL: 8.4 METERS.
  - 7.COMPONENT LOAD PER REEL: 500 PCS.

5

PIN	NO.	Dim B0	Dim W	Dim F	PCS/RELL	RELL/CARTON	PCS/CARTON
5	WF-1E254B5P	17.80	32	14.2	500	8	4000
6	WF-1E254B6P	20.30					
7	WF-1E254B7P	22.80					
8	WF-1E254B8P	25.30	44	20.2		6	3000
9	WF-1E254B9P	27.80					
10	WF-1E254B10P	30.30					
11	WF-1E254B11P	32.80	56	26.2	5	2500	
12	WF-1E254B12P	35.30					

GENERAL TOLERANCE		DONGGUAN BAOXUN PRECISION TECHNOLOGY CO., LTD				
DIM. TOL.		TITLE: 线对板针座 XHB2.54 带扣 立式贴片				
X $\pm 0.30$		DWG. NO.: WF-1E254BNP		DRAWN: MAX		
X.X $\pm 0.25$		PART NO.: WF-1E254BNP		CHECKED: ELLA		
X.XX $\pm 0.15$		UNIT: mm		SCALE: none		
X.XXX $\pm 0.15$		SHEET: 1 of 1		DWG. SIZE: A4		
GENERAL ANGLE: $\pm 3^\circ$		LAYER: bxconn		APPROVED: WILL		

## X-ON Electronics

Largest Supplier of Electrical and Electronic Components

*Click to view similar products for [Headers & Wire Housings](#) category:*

*Click to view products by [BXCONN](#) manufacturer:*

Other Similar products are found below :

[0015917161](#) [0022155065](#) [57102-F02-18ULF](#) [58102-G61-06LF](#) [582553-1](#) [01.001.5753.1](#) [0050291907](#) [02.125.8002.8](#) [609-3404](#) [61062-3](#)  
[CSU011177004](#) [622-0430](#) [622-3653LF](#) [63453-116](#) [636-1030](#) [636-1427](#) [636-3427](#) [636-4007](#) [641938-9](#) [65495-038](#) [65692-001LF](#) [65781-018](#)  
[65781-047](#) [65817-010LF](#) [65817-015LF](#) [67095-007LF](#) [67601157](#) [68631-112](#) [699319-000](#) [70.362.1628.0](#) [70-4210](#) [70-4226B](#) [70-4853B](#) [707-](#)  
[5028](#) [71.350.2428.0](#) [733-134](#) [733-162](#) [760-3052](#) [MHR-64-VUAL](#) [80.063.4001.1](#) [800-90-001-10-001000](#) [801-43-002-10-013000](#)  
[801-43-006-10-002000](#) [803-43-024-10-001000](#) [803-93-012-10-001000](#) [8-1437020-4](#) [819-22-004-30-001101](#) [820-22-006-30-001101](#)  
[820-22-008-30-001101](#) [821-22-002-10-001101](#)