

A

B

C

D

E

REV.	DESCRIPTION	ECN NO.	NAME	DATE

1

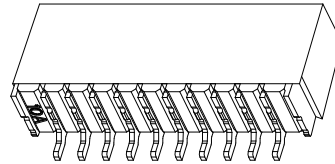
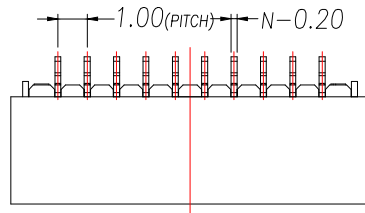

NOTES:

- Working temp:-25°C~85°C.
- Voltage rating:50V AC/DC(rms)
- Contact resistance:40mΩ max.
- Insulation resistance:100MΩ min.
- Current rating:1A AV/DC
- Withstanding Voltage:500V AC/minute
- Pin Retention Force:3N min.
- Housing material:LCP UL94-V0,Natural
- Terminal materl:Brass,
plating Ni 40u" min , plating Tin 100u"min.
- Solder tab material:Brass,
plating Ni 40u" min , plating Tin 100u"min.

2

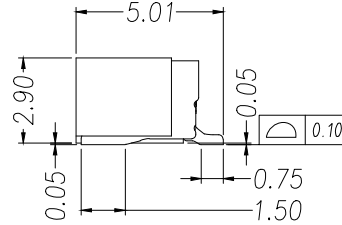
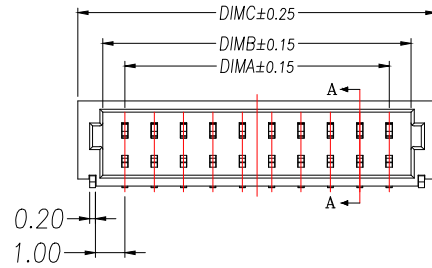

3

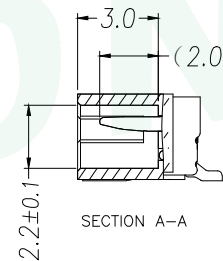
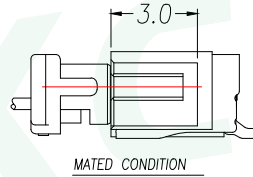
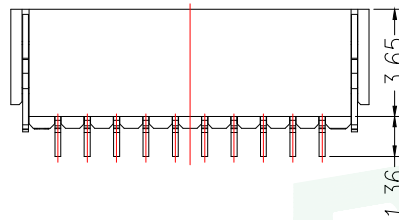

4

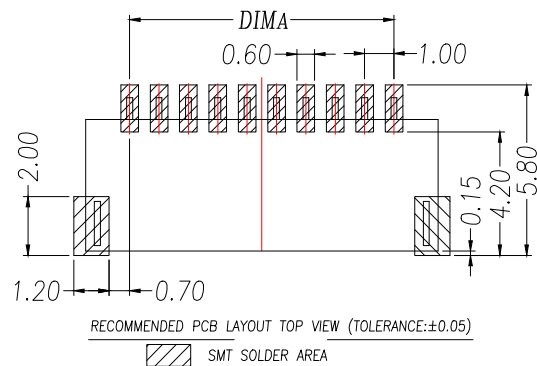

5

PIN	NO.	Dim A	Dim B	Dim C
2	WF-1F11002P	1.00	2.50	4.20
3	WF-1F11003P	2.00	3.50	5.20
4	WF-1F11004P	3.00	4.50	6.20
5	WF-1F11005P	4.00	5.50	7.20
6	WF-1F11006P	5.00	6.50	8.20
7	WF-1F11007P	6.00	7.50	9.20
8	WF-1F11008P	7.00	8.50	10.20
9	WF-1F11009P	8.00	9.50	11.20
10	WF-1F110010P	9.00	10.50	12.20
11	WF-1F110011P	10.00	11.50	13.20
12	WF-1F110012P	11.00	12.50	14.20
13	WF-1F110013P	12.00	13.50	15.20
14	WF-1F110014P	13.00	14.50	16.20
15	WF-1F110015P	14.00	15.50	17.20
16	WF-1F110016P	15.00	16.50	18.20

GENERAL TOLERANCE

DONGGUAN BAOXUN PRECISION TECHNOLOGY CO., LTD

BXCONN[®]

DIM.	TOL.
X	
X.X	±0.30
X.XX	±0.25
X.XXX	±0.15
GENERAL ANGLE:	±3°

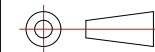

TITLE: 线对板插座 SH1.0 卧式贴片

DWG. NO.: WF-1F100ANP

DRAWN: MAX

PART NO.: WF-1F100ANP

CHECKED: ELLA

UNIT: mm

SCALE: none

SHEET: 1 of 1

DWG. SIZE: A4

LAYER: bxconn

APPROVED: WILL



A		B		C		D		E	
---	--	---	--	---	--	---	--	---	--

REV.	DESCRIPTION	ECN NO.	NAME	DATE

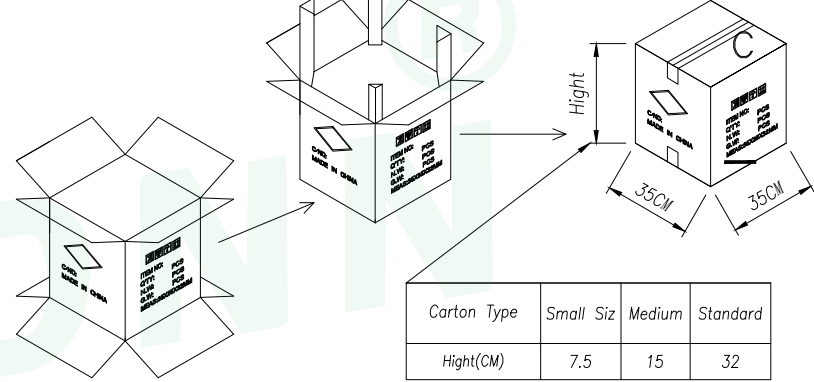
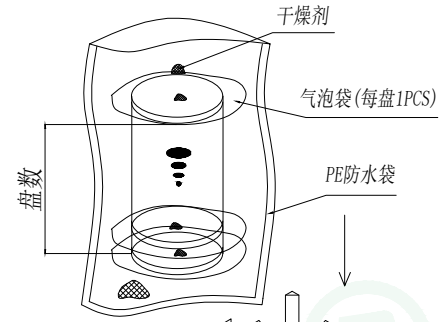
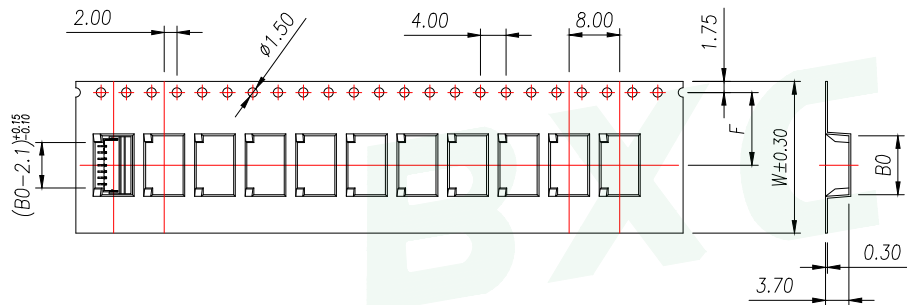
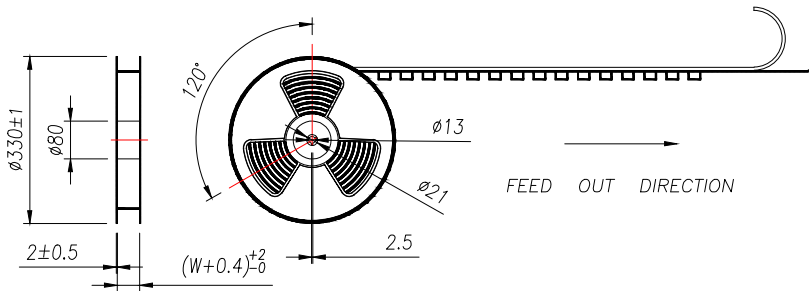
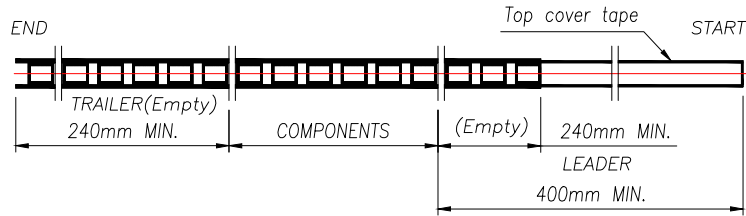



Carton Type	Small Siz	Medium	Standard
Height(CM)	7.5	15	32

NOTE:

- 1.10 SPROCKET HOLE PITCH CUMULATIVE TOLERANCE $\pm 0.2\text{mm}$.
- 2.CARRIER CAMBER NOT TO EXCEED 1mm IN 100mm.
- 3.ALL DIMENSIONS MEET EIA-481 REQUIREMENTS.
- 4.MATERIAL: CLEAR ANTISTATIC PS; COLD SEALING.
- 5.COMPONENT LOAD PER REEL: 2000 PCS.

PIN	NO.	B0	Dim W	Dim F	PCS/RELL	RELL/CARTON	PCS/CARTON
2	WF-1F11002P	4.30	16	7.50	2000	14	28000
3	WF-1F11003P	5.30					
4	WF-1F11004P	6.30					
5	WF-1F11005P	7.30					
6	WF-1F11006P	8.30	24	11.50	2000	10	20000
7	WF-1F11007P	9.30					
8	WF-1F11008P	10.30					
09	WF-1F11009P	11.30					
10	WF-1F110010P	12.30					
11	WF-1F110011P	13.30					
12	WF-1F110012P	14.30					
13	WF-1F110013P	15.30					

GENERAL TOLERANCE		DONGGUAN BAOXUN PRECISION TECHNOLOGY CO., LTD				 	
DIM.	TOL.	TITLE: 线对板针座 SH1.0 卧式贴片					
X		DWG. NO.: WF-1F100ANP					
X.X	± 0.30	DRAWN: MAX					
X.XX	± 0.25	CHECKED: ELLA					
X.XXX	± 0.15	PART NO.: WF-1F100ANP					
GENERAL	ANGLE: $\pm 3^\circ$	UNIT: mm	SCALE: none	SHEET: 1 of 1	DWG. SIZE: A4	LAYER: bxconn	APPROVED: WILL

REV.	DESCRIPTION	ECN NO.	NAME	DATE

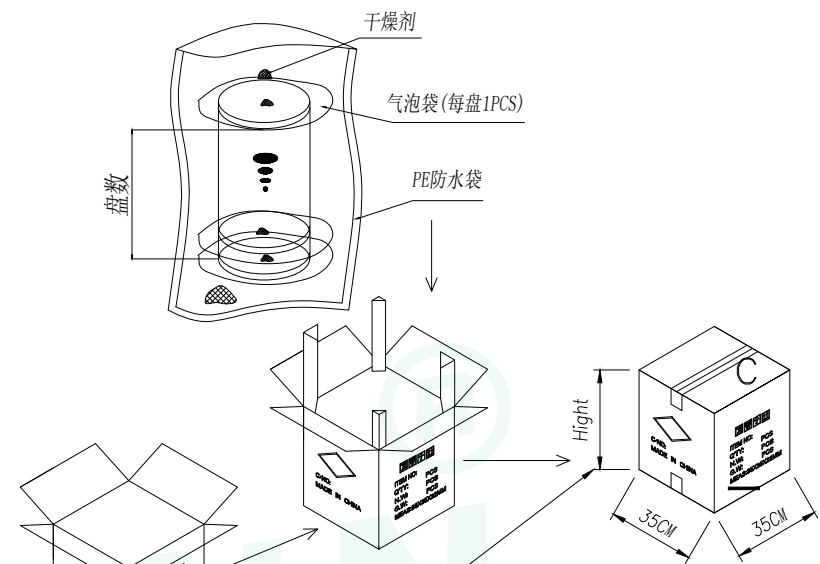
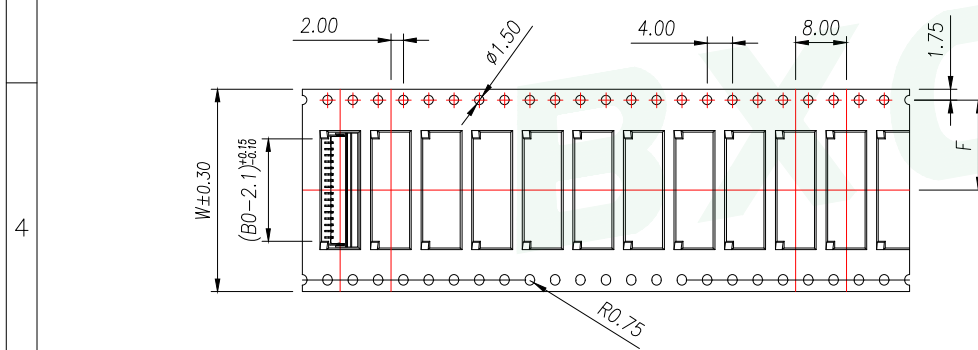
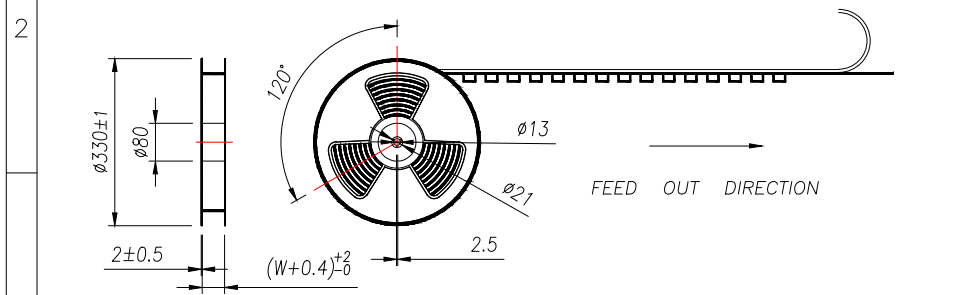
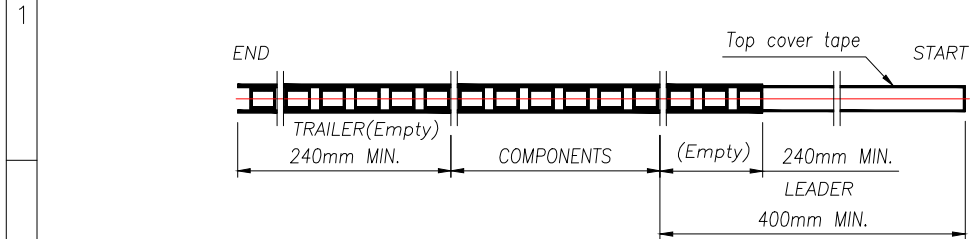

Carton Type	Small Siz	Medium	Standard
Hight(CM)	7.5	15	32

- NOTE:
- 1.10 SPROCKET HOLE PITCH CUMULATIVE TOLERANCE $\pm 0.2\text{mm}$.
 - 2.CARRIER CAMBER NOT TO EXCEED 1mm IN 100mm.
 - 3.ALL DIMENSIONS MEET EIA-481 REQUIREMENTS.
 - 4.MATERIAL: CLEAR ANTISTATIC PS, COLD SEALING.
 - 5.COMPONENT LOAD PER REEL: 2000 PCS.

PIN	NO.	B0	Dim W	Dim F	PCS/RELL	RELL/CARTON	PCS/CARTON
14	WF-1F110014P	16.30	32	14.2	2000	8	16000
15	WF-1F110015P	17.30					
16	WF-1F110016P	18.30					

GENERAL TOLERANCE	DONGGUAN BAOXUN PRECISION TECHNOLOGY CO., LTD				
DIM. TOL.	TITLE: 线对板针座 SH1.0 卧式贴片				
X	DWG. NO.: WF-1F100ANP		DRAWN: MAX		
X.X ± 0.30	PART NO.: WF-1F100ANP		CHECKED: ELLA		
X.XX ± 0.25	UNIT: mm	SCALE: none	SHEET: 1 of 1	DWG. SIZE: A4	LAYER: bxconn
X.XXX ± 0.15	APPROVED: WILL				
GENERAL ANGLE: $\pm 3^\circ$					



X-ON Electronics

Largest Supplier of Electrical and Electronic Components

Click to view similar products for [Headers & Wire Housings](#) category:

Click to view products by [BXCONN](#) manufacturer:

Other Similar products are found below :

[0015917161](#) [0022155065](#) [57102-F02-18ULF](#) [58102-G61-06LF](#) [582553-1](#) [01.001.5753.1](#) [0050291907](#) [02.125.8002.8](#) [609-3404](#) [61062-3](#)
[CSU011177004](#) [622-0430](#) [622-3653LF](#) [63453-116](#) [636-1030](#) [636-1427](#) [636-3427](#) [636-4007](#) [641938-9](#) [65495-038](#) [65692-001LF](#) [65781-018](#)
[65781-047](#) [65817-010LF](#) [65817-015LF](#) [67095-007LF](#) [67601157](#) [68631-112](#) [699319-000](#) [70.362.1628.0](#) [70-4210](#) [70-4226B](#) [70-4853B](#) [707-](#)
[5028](#) [71.350.2428.0](#) [733-134](#) [733-162](#) [760-3052](#) [MHR-64-VUAL](#) [80.063.4001.1](#) [800-90-001-10-001000](#) [801-43-002-10-013000](#)
[801-43-006-10-002000](#) [803-43-024-10-001000](#) [803-93-012-10-001000](#) [8-1437020-4](#) [819-22-004-30-001101](#) [820-22-006-30-001101](#)
[820-22-008-30-001101](#) [821-22-002-10-001101](#)