

NOTES:

1. Working temp: -25°C~85°C.
2. Voltage rating: 50V AV/DC(rms)
3. Contact resistance: 50mΩ max.
4. Insulation resistance: 100MΩ min.
5. Current rating: 1A AV/DC
6. Withstanding Voltage: 500V AC/minute
7. Pin Retention Force: 10N min.
8. Housing material: LCP UL94-V0, Natural
9. Terminal materl: Brass,  
plating Ni 50u" min , plating Tin 100u" min.
10. Solder tab material: Brass,  
plating Ni 50u" min , plating Tin 100u" min.

PIN	NO.	Dim A	Dim B	Dim C
2	WF-1F125B2P	1.25	3.80	5.75
3	WF-1F125B3P	2.50	5.05	7.00
4	WF-1F125B4P	3.75	6.30	8.25
5	WF-1F125B5P	5.00	7.55	9.50
6	WF-1F125B6P	6.25	8.80	10.75
7	WF-1F125B7P	7.50	10.05	12.00
8	WF-1F125B8P	8.75	11.30	13.25
9	WF-1F125B9P	10.00	12.55	14.50
10	WF-1F125B10P	11.25	13.80	15.75
11	WF-1F125B11P	12.50	15.05	17.00
12	WF-1F125B12P	13.75	16.30	18.25
13	WF-1F125B13P	15.00	17.55	19.50
14	WF-1F125B14P	16.25	18.80	20.75
15	WF-1F125B15P	17.50	20.05	22.00
16	WF-1F125B16P	18.75	21.30	23.25

GENERAL TOLERANCE	DONGGUAN BAOXUN PRECISION TECHNOLOGY CO., LTD				
DIM. TOL.	TITLE: 线对板针座 GH1.25 卧式贴片				
X	±0.30	DWG. NO.: WF-1F125BNP			DRAWN: MAX
X.X	±0.25	PART NO.: WF-1F125BNP			CHECKED: ELLA
X.XX	±0.15	UNIT: mm	SCALE: none	SHEET: 1 of 1	APPROVED: WILL
X.XXX	±0.15	DWG. SIZE: A4	LAYER: bxconn		
GENERAL ANGLE:	±3°				

**BXCONN**®



REV.	DESCRIPTION	ECN NO.	NAME	DATE

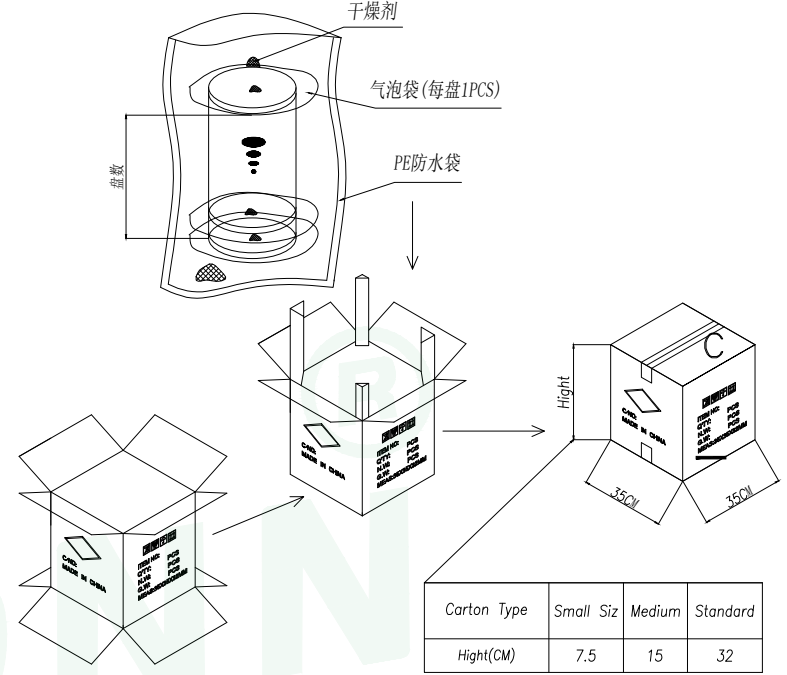
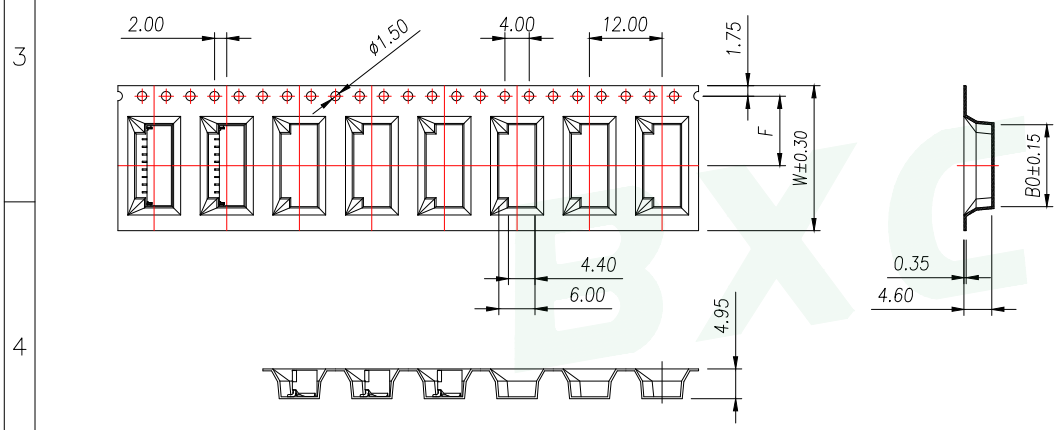
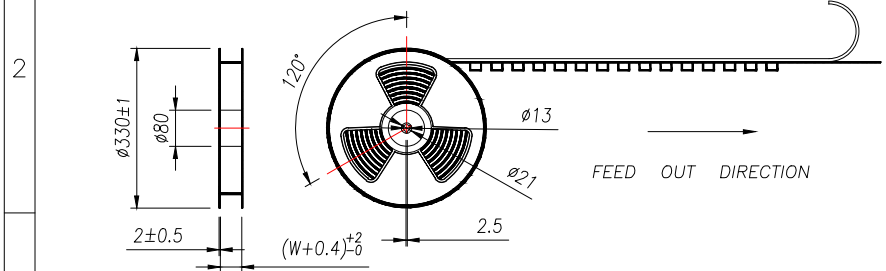
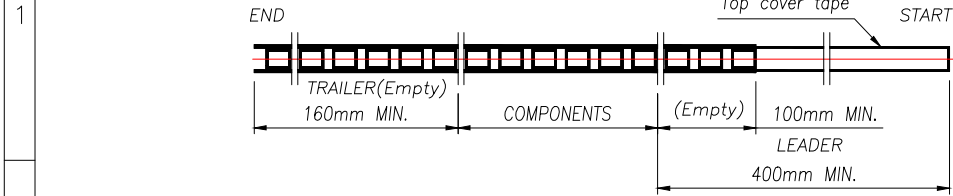

Carton Type	Small Siz	Medium	Standard
Hight(CM)	7.5	15	32

NOTE:  
 1.10 SPROCKET HOLE PITCH CUMULATIVE TOLERANCE ±0.2mm.  
 2.CARRIER CAMBER NOT TO EXCEED 1mm IN 100mm.  
 3.ALL DIMENSIONS MEET EIA-481 REQUIREMENTS.  
 4.MATERIAL: CLEAR ANTISTATIC PS, COLD SEALING.  
 5.THICKNESS: 0.35±0.05mm.  
 6.PACKING LENGTH PER REEL: 12.4 METERS.  
 7.COMPONENT LOAD PER REEL: 1000 PCS.

PIN	NO.	Dim B0	Dim W	Dim F	PCS/RELL	RELL/CARTON	PCS/CARTON
2	WF-1F125B2P	8.20	16	7.5	1000	14	14000
3	WF-1F125B3P	10.20					
4	WF-1F125B4P	12.20					
5	WF-1F125B5P	14.20					
6	WF-1F125B6P	16.20	24	11.50		10	10000
7	WF-1F125B7P	18.20					
8	WF-1F125B8P	20.20					
9	WF-1F125B9P	22.20					

GENERAL TOLERANCE		DONGGUAN BAOXUN PRECISION TECHNOLOGY CO., LTD			
DIM.	TOL.	TITLE: 线对板针座 GH1.25 卧式贴片			
X	±0.30	DWG. NO.: WF-1F125BNP		DRAWN: MAX	
X.X	±0.25	PART NO.: WF-1F125BNP		CHECKED: ELLA	
X.XX	±0.15	UNIT: mm		APPROVED: WILL	
X.XXX	±0.15	SCALE: none	SHEET: 1 of 1	DWG. SIZE: A4	LAYER: bxcn
GENERAL ANGLE:	±3°				



REV.	DESCRIPTION	ECN NO.	NAME	DATE

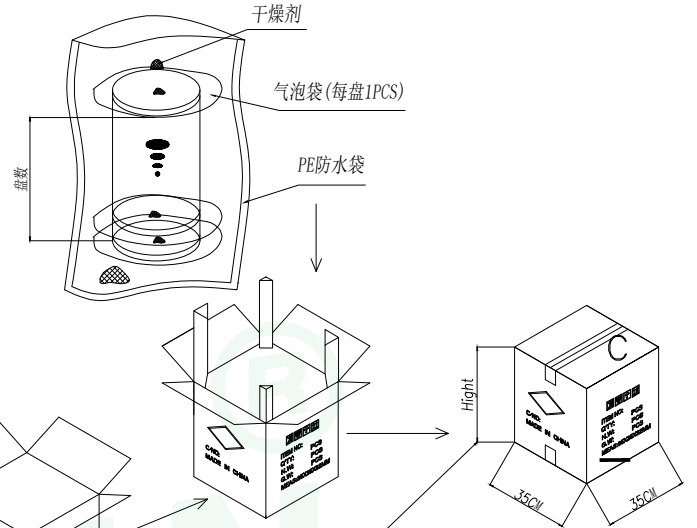
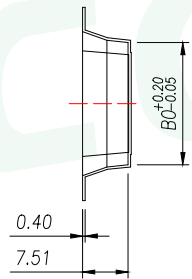
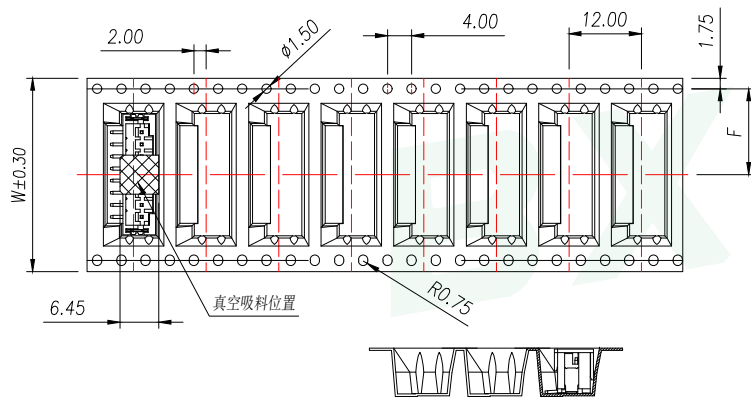
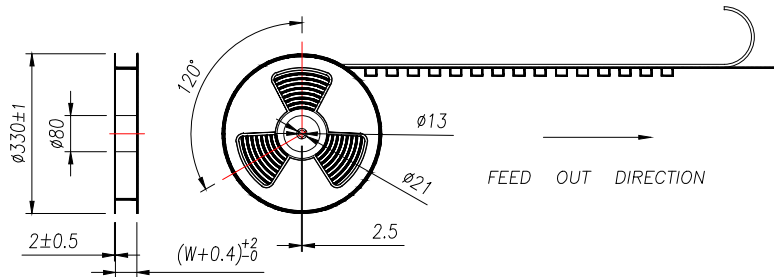
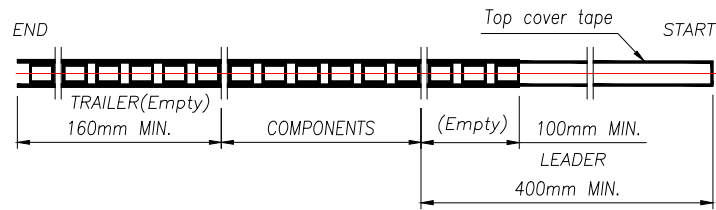

Carton Type	Small Siz	Medium	Standard
Hight(CM)	7.5	15	32

- NOTE:
- 1.10 SPROCKET HOLE PITCH CUMULATIVE TOLERANCE ±0.2mm.
  - 2.CARRIER CAMBER NOT TO EXCEED 1mm IN 100mm.
  - 3.ALL DIMENSIONS MEET EIA-481 REQUIREMENTS.
  - 4.MATERIAL: CLEAR ANTISTATIC PS, COLD SEALING.
  - 5.THICKNESS: 0.35±0.05mm.
  - 6.PACKING LENGHT PER REEL: 12.4 METERS.
  - 7.COMPONENT LOAD PER REEL: 1000 PCS.

PIN	NO.	Dim B0	Dim W	Dim F	PCS/RELL	RELL/CARTON	PCS/CARTON
10	WF-1F125B10P	16.05	32	14.2	1000	8	8000
11	WF-1F125B11P	17.30					
12	WF-1F125B12P	18.55					
13	WF-1F125B13P	19.80					
14	WF-1F125B14P	21.05	44	20.2	6	6000	
15	WF-1F125B15P	22.30					
16	WF-1F125B16P	23.55					

GENERAL TOLERANCE		DONGGUAN BAOXUN PRECISION TECHNOLOGY CO., LTD				
DIM.	TOL.	TITLE: 线对板针座 GH1.25 卧式贴片				
X		DWG. NO.: WF-1F125BNP		DRAWN: MAX		
X.X	±0.30	PART NO.: WF-1F125BNP		CHECKED: ELLA		
X.XX	±0.25	UNIT: mm		APPROVED: WILL		
X.XXX	±0.15	SCALE: none	SHEET: 1 of 1	DWG. SIZE: A4	LAYER: bxconn	
GENERAL	ANGLE: ±3°					

## X-ON Electronics

Largest Supplier of Electrical and Electronic Components

*Click to view similar products for [Headers & Wire Housings](#) category:*

*Click to view products by [BXCONN](#) manufacturer:*

Other Similar products are found below :

[0015917161](#) [0022155065](#) [57102-F02-18ULF](#) [58102-G61-06LF](#) [582553-1](#) [01.001.5753.1](#) [0050291907](#) [02.125.8002.8](#) [609-3404](#) [61062-3](#)  
[CSU011177004](#) [622-0430](#) [622-3653LF](#) [63453-116](#) [636-1030](#) [636-1427](#) [636-3427](#) [636-4007](#) [641938-9](#) [65495-038](#) [65692-001LF](#) [65781-018](#)  
[65781-047](#) [65817-010LF](#) [65817-015LF](#) [67095-007LF](#) [67601157](#) [68631-112](#) [699319-000](#) [70.362.1628.0](#) [70-4210](#) [70-4226B](#) [70-4853B](#) [707-](#)  
[5028](#) [71.350.2428.0](#) [733-134](#) [733-162](#) [760-3052](#) [MHR-64-VUAL](#) [80.063.4001.1](#) [800-90-001-10-001000](#) [801-43-002-10-013000](#)  
[801-43-006-10-002000](#) [803-43-024-10-001000](#) [803-93-012-10-001000](#) [8-1437020-4](#) [819-22-004-30-001101](#) [820-22-006-30-001101](#)  
[820-22-008-30-001101](#) [821-22-002-10-001101](#)