

REV.	DESCRIPTION	ECN NO.	NAME	DATE

1
2
3
4
5

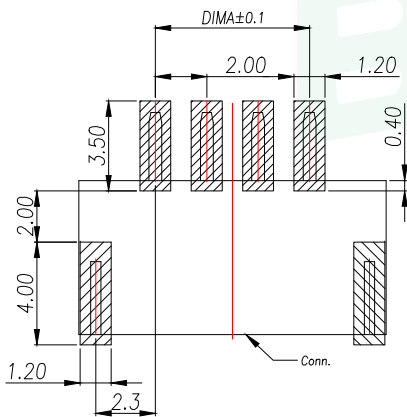
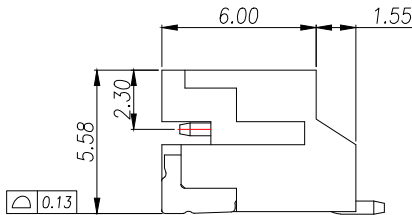
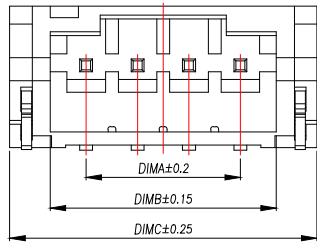
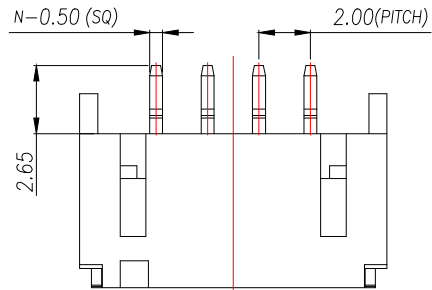

RECOMMENDED PCB LAYOUT TOP VIEW (TOLERANCE:±0.05)

SMT SOLDER AREA

NOTES:

1. Working temp: -25°C~85°C.
2. Voltage rating: 100V AV/DC(rms)
3. Contact resistance: 20mΩ max.
4. Insulation resistance: 1000MΩ min.
5. Current rating: 2A AV/DC
6. Withstanding Voltage: 800V AC/minute
7. Pin Retention Force: 15N min.
8. Housing material: LCP UL94-V0, Natural
9. Terminal materl: Brass,
plating Ni 50u" min , plating Tin 100u"min.
10. Solder tab material: Brass,
plating Ni 50u" min , plating Tin 100u"min.

PIN	NO.	Dim A	Dim B	Dim C
2	WF-1F200A2P	2.00	4.80	7.95
3	WF-1F200A3P	4.00	6.80	9.95
4	WF-1F200A4P	6.00	8.80	11.95
5	WF-1F200A5P	8.00	10.80	13.95
6	WF-1F200A6P	10.00	12.80	15.95
7	WF-1F200A7P	12.00	14.80	17.95
8	WF-1F200A8P	14.00	16.80	19.95
9	WF-1F200A9P	16.00	18.80	21.95
10	WF-1F200A10P	18.00	20.80	23.95
11	WF-1F200A11P	20.00	22.80	25.95
12	WF-1F200A12P	22.00	24.80	27.95
13	WF-1F200A13P	24.00	26.80	29.95
14	WF-1F200A14P	26.00	28.80	31.95
15	WF-1F200A15P	28.00	30.80	33.95
16	WF-1F200A16P	30.00	32.80	35.95

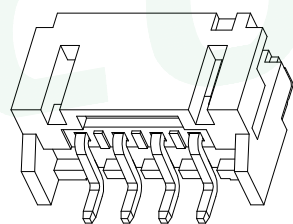

GENERAL TOLERANCE		DONGGUAN BAOXUN PRECISION TECHNOLOGY CO., LTD			
DIM.	TOL.	TITLE: 线对板针座 PH2.0 卧式贴片			
X		DWG. NO.: WF-1F200ANP		DRAWN: MAX	
X.X	±0.30	PART NO.: WF-1F200ANP		CHECKED: ELLA	
X.XX	±0.25	UNIT: mm	SCALE: none	SHEET: 1 of 1	APPROVED: WILL
X.XXX	±0.15	DWG. SIZE: A4	LAYER: bxconn		
GENERAL ANGLE:	±3°				

BXCONN[®]



REV.	DESCRIPTION	ECN NO.	NAME	DATE

1

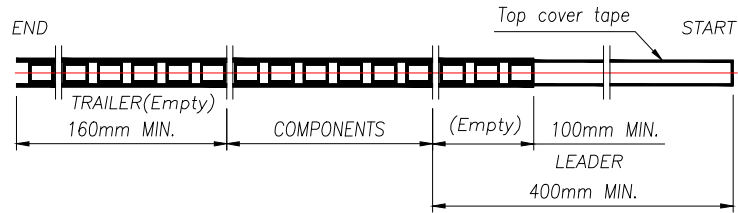

2

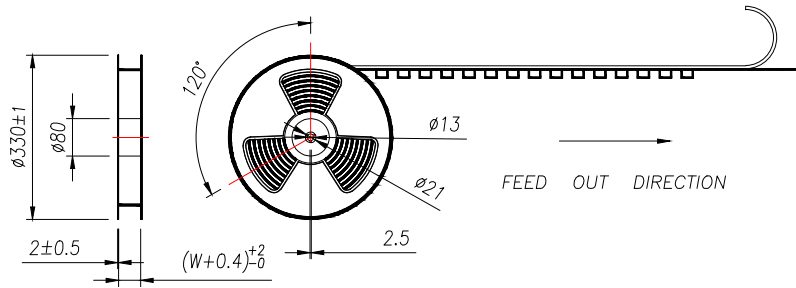

3

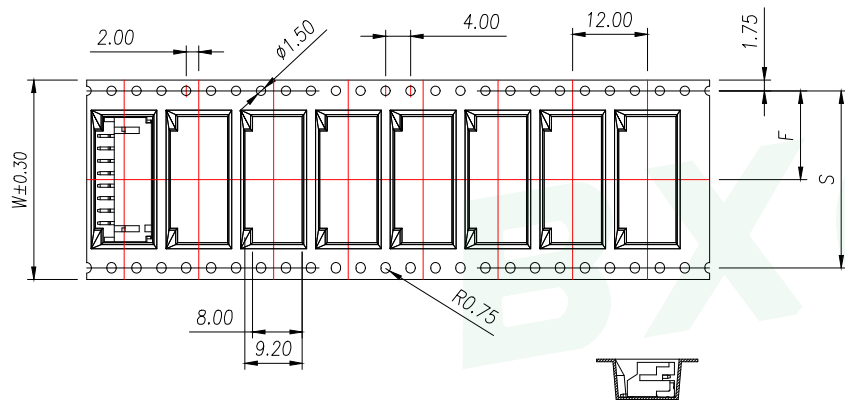

4

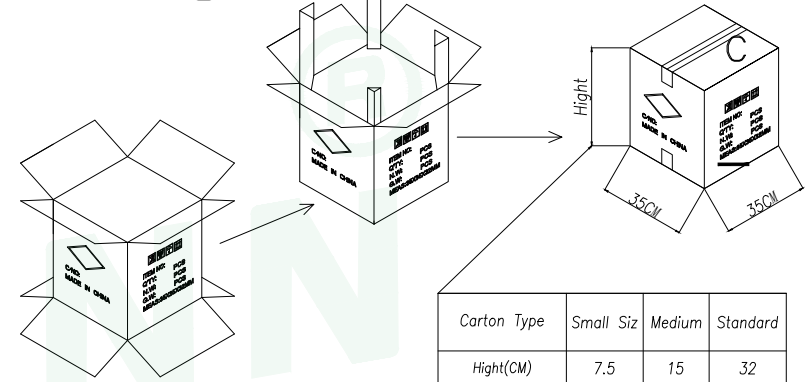
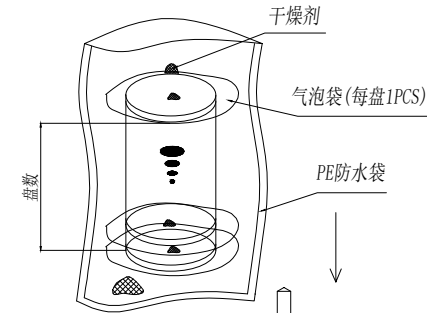
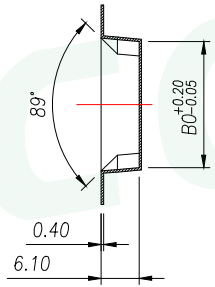

Carton Type	Small Siz	Medium	Standard
Hight(CM)	7.5	15	32

- NOTE:
- 1.SPROCKET HOLE PITCH CUMULATIVE TOLERANCE ±0.2mm.
 - 2.CARRIER CAMBER NOT TO EXCEED 1mm IN 100mm.
 - 3.ALL DIMENSIONS MEET EIA-481 REQUIREMENTS.
 - 4.MATERIAL: CLEAR ANTISTATIC PS, COLD SEALING.
 - 5.THICKNESS: 0.40±0.05mm.
 - 6.PACKING LENGTH PER REEL: 12.4 METERS.
 - 7.COMPONENT LOAD PER REEL: 1000 PCS.

PIN	NO.	Dim B0	Dim W	Dim F	PCS/RELL	RELL/CARTON	PCS/CARTON
6	WF-1F200A6P	16.25	32	14.2	1000	8	8000
7	WF-1F200A7P	18.25					
8	WF-1F200A8P	20.25					
9	WF-1F200A9P	22.25	44	20.2		6	6000
10	WF-1F200A10P	24.25					
11	WF-1F200A11P	26.25					
12	WF-1F200A12P	28.25	56	26.2	5	5000	
13	WF-1F200A13P	30.25					
14	WF-1F200A14P	32.25					
15	WF-1F200A15P	34.25					
16	WF-1F200A16P	36.25					

5

GENERAL TOLERANCE	DONGGUAN BAOXUN PRECISION TECHNOLOGY CO., LTD				
DIM. TOL.	TITLE: 线对板针座 PH2.0 卧式贴片				
X ±0.30	DWG. NO.: WF-1F200ANP		DRAWN: MAX		
X.X ±0.25	PART NO.: WF-1F200ANP		CHECKED: ELLA		
X.XX ±0.15	UNIT: mm	SCALE: none	SHEET: 1 of 1	DWG. SIZE: A4	LAYER: bxconn
X.XXX ±0.10	APPROVED: WILL				
GENERAL ANGLE: ±3°					



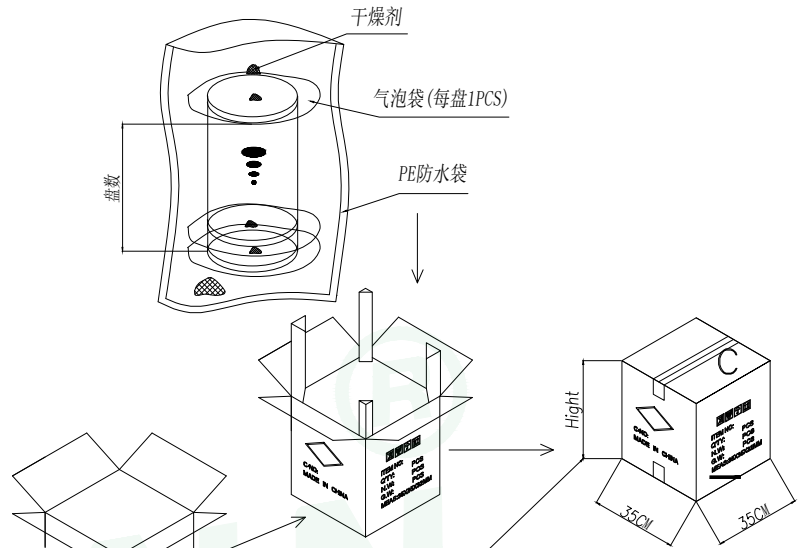
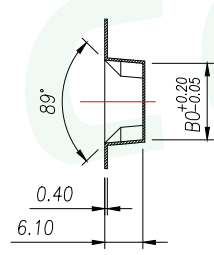
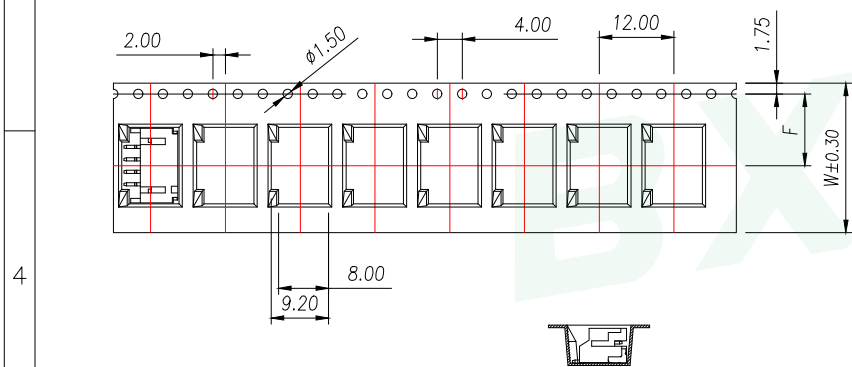
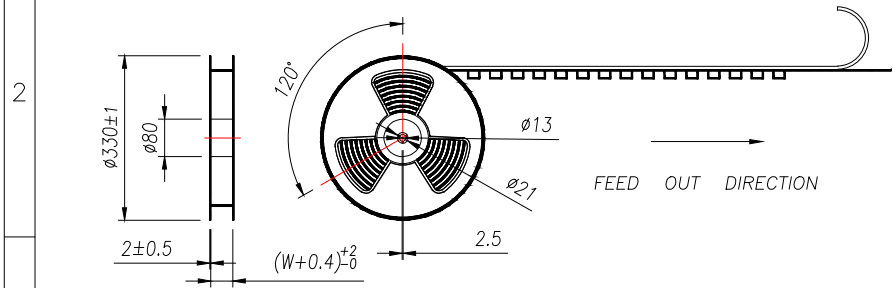
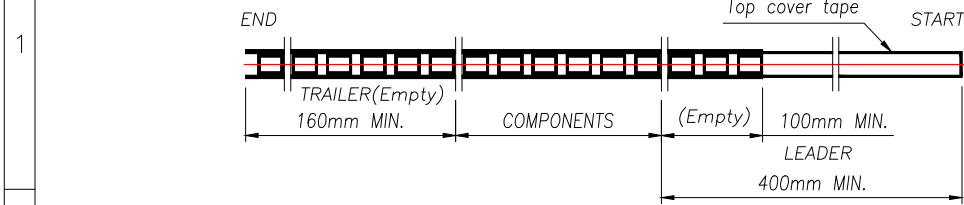

REV.	DESCRIPTION	ECN NO.	NAME	DATE



Carton Type	Small Siz	Medium	Standard
Hight(CM)	7.5	15	32

- NOTE:
- 1.10 SPROCKET HOLE PITCH CUMULATIVE TOLERANCE $\pm 0.2\text{mm}$.
 - 2.CARRIER CAMBER NOT TO EXCEED 1mm IN 100mm.
 - 3.ALL DIMENSIONS MEET EIA-481 REQUIREMENTS.
 - 4.MATTRIAL: CLEAR ANTISTATIC PS, COLD SEALING.
 - 5.THICKNESS: $0.40 \pm 0.05\text{mm}$.
 - 6.PACKING LENGHT PER REEL: 12.4 METERS.
 - 7.COMPONENT LOAD PER REEL: 1000 PCS.

PIN	NO.	Dim B0	Dim W	Dim F	PCS/RELL	RELL/CARTON	PCS/CARTON
2	WF-1F200A2P	8.25	16	7.5	1000	14	14000
3	WF-1F200A3P	10.25	24	11.50		10	10000
4	WF-1F200A4P	12.25					
5	WF-1F200A5P	14.25					

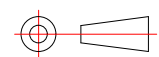
GENERAL TOLERANCE		DONGGUAN BAOXUN PRECISION TECHNOLOGY CO., LTD				 
DIM. TOL.		TITLE: 线对板针座 PH2.0 卧式贴片				
X		DWG. NO.: WF-1F200ANP				
X.X ± 0.30		DRAWN: MAX				
X.XX ± 0.25		PART NO.: WF-1F200ANP				
X.XXX ± 0.15		CHECKED: ELLA				
GENERAL ANGLE: $\pm 3^\circ$		APPROVED: WILL				
		UNIT: mm	SCALE: none	SHEET: 1 of 1	DWG. SIZE: A4	LAYER: bxconn

X-ON Electronics

Largest Supplier of Electrical and Electronic Components

Click to view similar products for [Headers & Wire Housings](#) category:

Click to view products by [BXCONN](#) manufacturer:

Other Similar products are found below :

[0015917161](#) [0022155065](#) [57102-F02-18ULF](#) [58102-G61-06LF](#) [582553-1](#) [01.001.5753.1](#) [0050291907](#) [02.125.8002.8](#) [609-3404](#) [61062-3](#)
[CSU011177004](#) [622-0430](#) [622-3653LF](#) [63453-116](#) [636-1030](#) [636-1427](#) [636-3427](#) [636-4007](#) [641938-9](#) [65495-038](#) [65692-001LF](#) [65781-018](#)
[65781-047](#) [65817-010LF](#) [65817-015LF](#) [67095-007LF](#) [67601157](#) [68631-112](#) [699319-000](#) [70.362.1628.0](#) [70-4210](#) [70-4226B](#) [70-4853B](#) [707-](#)
[5028](#) [71.350.2428.0](#) [733-134](#) [733-162](#) [760-3052](#) [MHR-64-VUAL](#) [80.063.4001.1](#) [800-90-001-10-001000](#) [801-43-002-10-013000](#)
[801-43-006-10-002000](#) [803-43-024-10-001000](#) [803-93-012-10-001000](#) [8-1437020-4](#) [819-22-004-30-001101](#) [820-22-006-30-001101](#)
[820-22-008-30-001101](#) [821-22-002-10-001101](#)