



NOTES:

1. Working temp: -25°C~85°C.
2. Voltage rating: 100V AV/DC(rms)
3. Contact resistance: 20mΩ max.
4. Insulation resistance: 1000MΩ min.
5. Current rating: 2A AV/DC
6. Withstanding Voltage: 800V AC/minute
7. Pin Retention Force: 15N min.
8. Housing material: LCP UL94-V0, Natural
9. Terminal materl: Brass,
plating Ni 50u" min , plating Tin 100u"min.
10. Solder tab material: Brass,
plating Ni 50u" min , plating Tin 100u"min.

PIN	NO.	Dim A	Dim B	Dim C
2	WF-1F200B2P	2.00	4.90	8.00
3	WF-1F200B3P	4.00	6.90	10.00
4	WF-1F200B4P	6.00	8.90	12.00
5	WF-1F200B5P	8.00	10.90	14.00
6	WF-1F200B6P	10.00	12.90	16.00
7	WF-1F200B7P	12.00	14.90	18.00
8	WF-1F200B8P	14.00	16.90	20.00
9	WF-1F200B9P	16.00	18.90	22.00
10	WF-1F200B10P	18.00	20.90	24.00
11	WF-1F200B11P	20.00	22.90	26.00
12	WF-1F200B12P	22.00	24.90	28.00
13	WF-1F200B13P	24.00	26.90	30.00
14	WF-1F200B14P	26.00	28.90	32.00
15	WF-1F200B15P	28.00	30.90	34.00
16	WF-1F200B16P	30.00	32.90	36.00

GENERAL TOLERANCE		DONGGUAN BAOXUN PRECISION TECHNOLOGY CO., LTD				 
DIM.	TOL.	TITLE: 线对板针座 HY2.0 带扣 卧式贴片				
X		DWG. NO.: WF-1F200BNP		DRAWN: MAX		
X.X	±0.30	PART NO.: WF-1F200BNP		CHECKED: ELLA		
X.XX	±0.25	UNIT: mm		APPROVED: WILL		
X.XXX	±0.15	SCALE: none	SHEET: 1 of 1	DWG. SIZE: A4	LAYER: bxconn	
GENERAL ANGLE: ±3°						

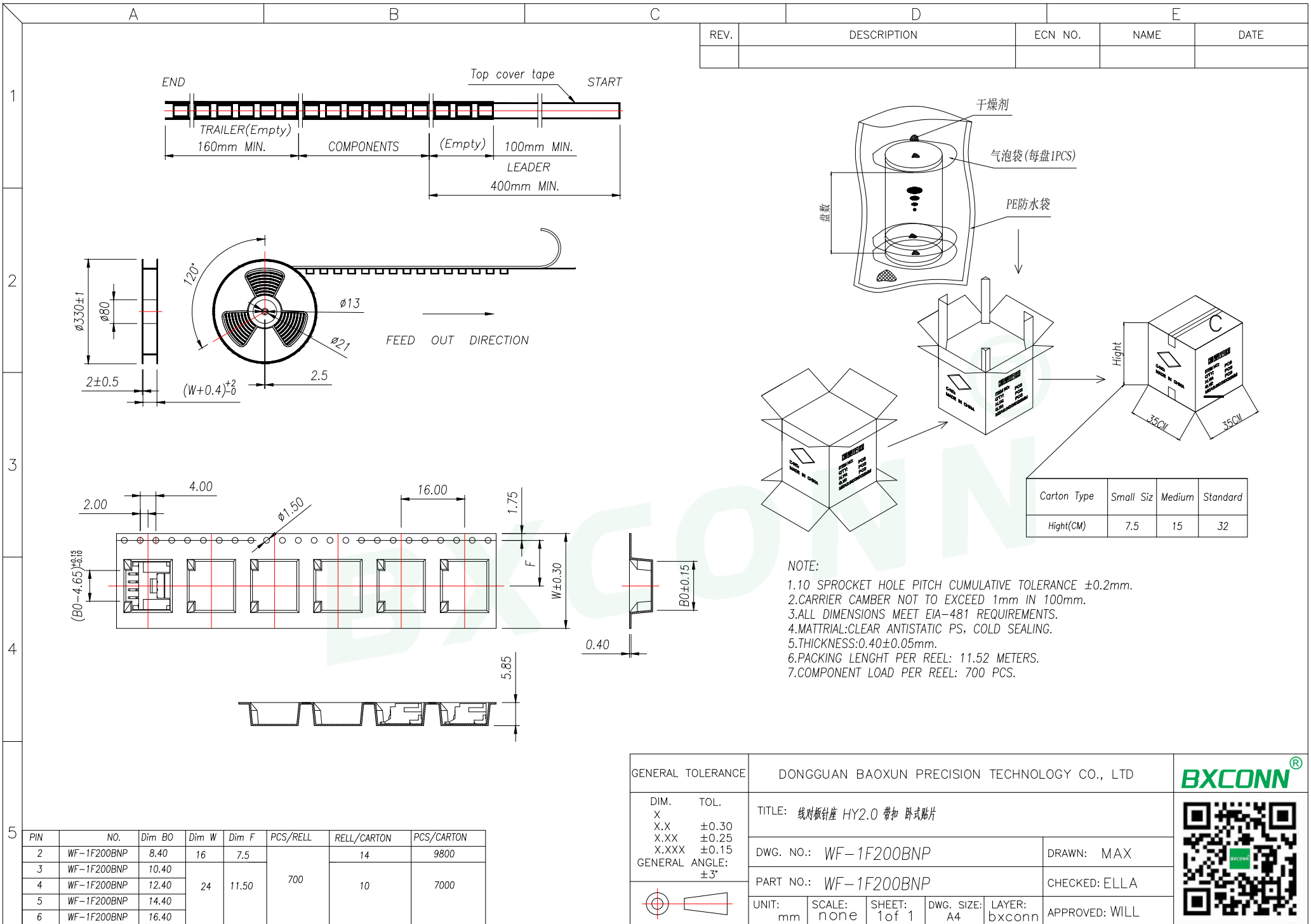

REV.	DESCRIPTION	ECN NO.	NAME	DATE

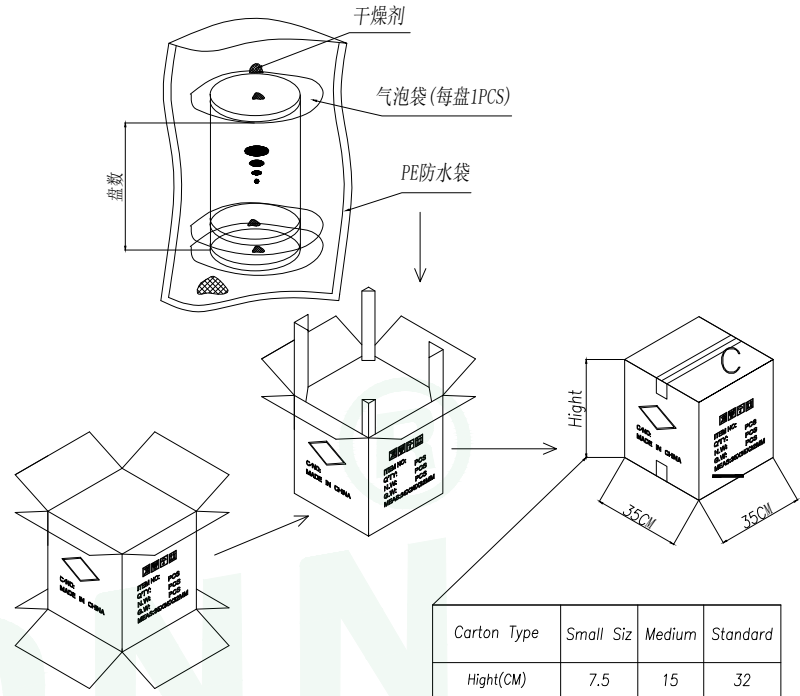

Carton Type	Small Siz	Medium	Standard
Height(CM)	7.5	15	32

- NOTE:
- 1.10 SPROCKET HOLE PITCH CUMULATIVE TOLERANCE $\pm 0.2\text{mm}$.
 2. CARRIER CAMBER NOT TO EXCEED 1mm IN 100mm.
 3. ALL DIMENSIONS MEET EIA-481 REQUIREMENTS.
 4. MATERIAL: CLEAR ANTISTATIC PS, COLD SEALING.
 5. THICKNESS: $0.40 \pm 0.05\text{mm}$.
 6. PACKING LENGTH PER REEL: 11.52 METERS.
 7. COMPONENT LOAD PER REEL: 700 PCS.

GENERAL TOLERANCE		DONGGUAN BAOXUN PRECISION TECHNOLOGY CO., LTD			
DIM.	TOL.	TITLE: 线对板针座 HY2.0 带扣 卧式贴片			
X		DWG. NO.: WF-1F200BNP		DRAWN: MAX	
X.X	± 0.30	PART NO.: WF-1F200BNP		CHECKED: ELLA	
X.XX	± 0.25	UNIT: mm		SCALE: none	APPROVED: WILL
X.XXX	± 0.15	SHEET: 1 of 1	DWG. SIZE: A4	LAYER: bxconn	
GENERAL ANGLE:	$\pm 3^\circ$				

BXCONN[®]



PIN	NO.	Dim B0	Dim W	Dim F	PCS/RELL	RELL/CARTON	PCS/CARTON
2	WF-1F200BNP	8.40	16	7.5	700	14	9800
3	WF-1F200BNP	10.40	24	11.50		10	7000
4	WF-1F200BNP	12.40					
5	WF-1F200BNP	14.40					
6	WF-1F200BNP	16.40					

REV.	DESCRIPTION	ECN NO.	NAME	DATE

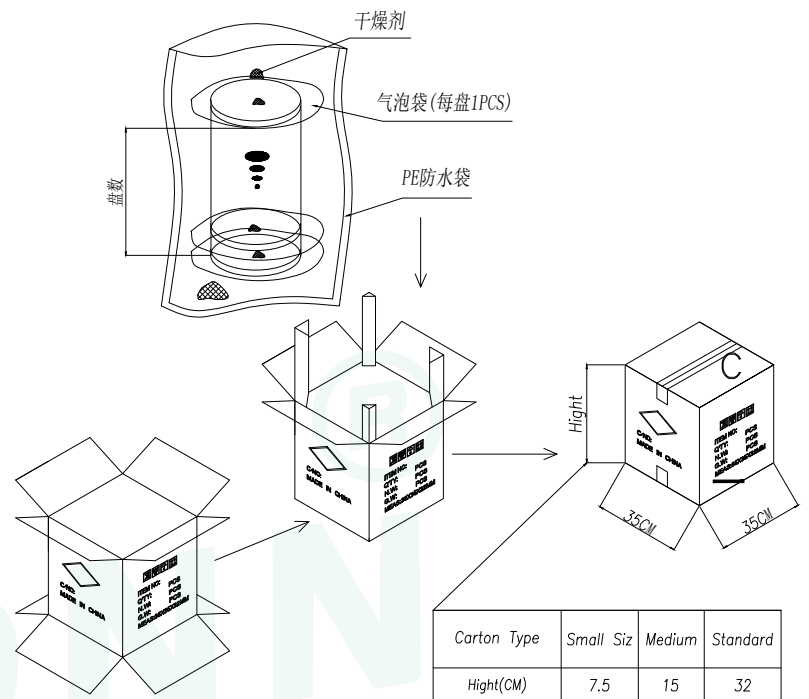
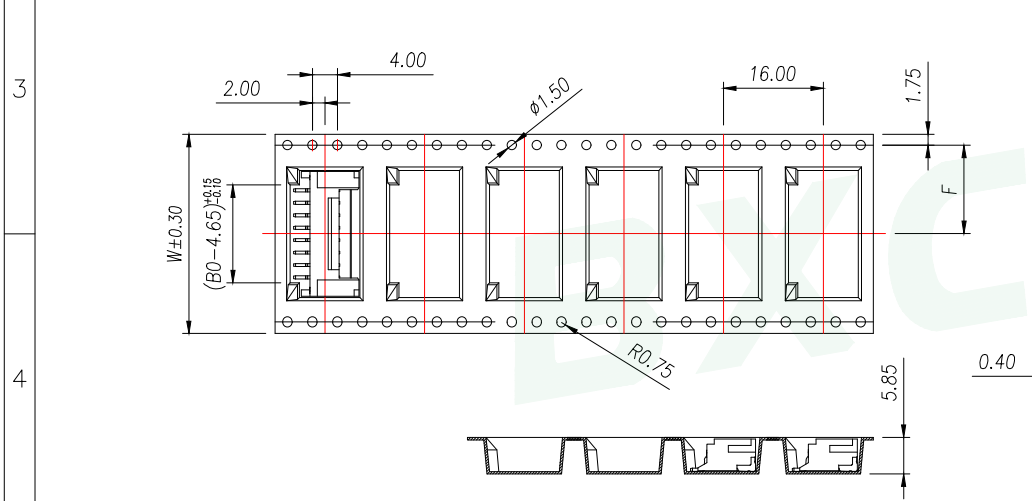
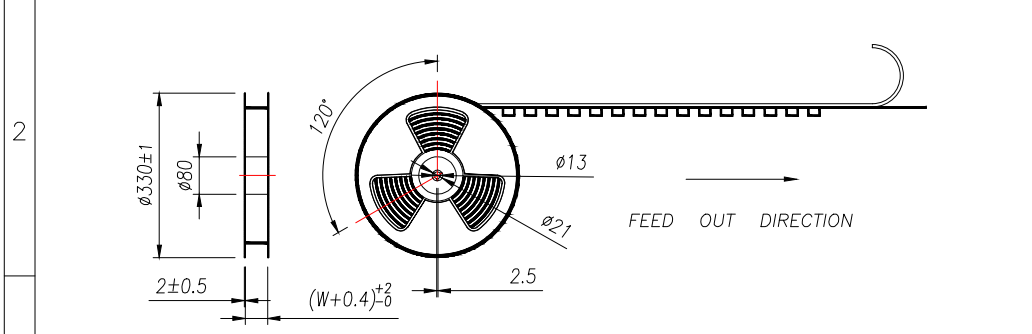
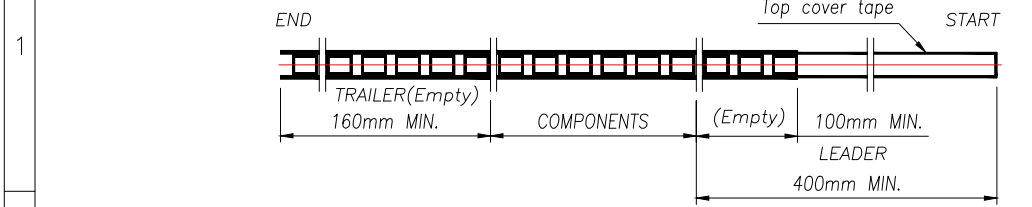

- NOTE:
- 1.10 SPROCKET HOLE PITCH CUMULATIVE TOLERANCE $\pm 0.2\text{mm}$.
 - 2.CARRIER CAMBER NOT TO EXCEED 1mm IN 100mm.
 - 3.ALL DIMENSIONS MEET EIA-481 REQUIREMENTS.
 - 4.MATERIAL: CLEAR ANTISTATIC PS, COLD SEALING.
 - 5.THICKNESS: $0.40 \pm 0.05\text{mm}$.
 - 6.PACKING LENGHT PER REEL: 11.52 METERS.
 - 7.COMPONENT LOAD PER REEL: 700 PCS.

PIN	NO.	Dim B0	Dim W	Dim F	PCS/RELL	RELL/CARTON	PCS/CARTON	
7	WF-1F200B7P	18.40	32	14.2	700	8	5600	
8	WF-1F200B8P	20.40						
9	WF-1F200B9P	22.40						
10	WF-1F200B10P	24.40	44	20.2		6		4200
11	WF-1F200B11P	26.40						
12	WF-1F200B12P	28.40						
13	WF-1F200B13P	30.40	56	26.2	5	3500		
14	WF-1F200B14P	32.40						
15	WF-1F200B15P	34.40						
16	WF-1F200B16P	36.40						

GENERAL TOLERANCE		DONGGUAN BAOXUN PRECISION TECHNOLOGY CO., LTD			
DIM.	TOL.	TITLE: 线对板针座 HY2.0 带扣 卧式贴片			
X		DWG. NO.: WF-1F200BNP		DRAWN: MAX	
X.X	± 0.30	PART NO.: WF-1F200BNP		CHECKED: ELLA	
X.XX	± 0.25	UNIT: mm		APPROVED: WILL	
X.XXX	± 0.15	SCALE: none	SHEET: 1 of 1	DWG. SIZE: A4	LAYER: bxconn
GENERAL ANGLE:	$\pm 3^\circ$				



X-ON Electronics

Largest Supplier of Electrical and Electronic Components

Click to view similar products for [Headers & Wire Housings](#) category:

Click to view products by [BXCONN](#) manufacturer:

Other Similar products are found below :

[0015917161](#) [0022155065](#) [57102-F02-18ULF](#) [58102-G61-06LF](#) [582553-1](#) [01.001.5753.1](#) [0050291907](#) [02.125.8002.8](#) [609-3404](#) [61062-3](#)
[CSU011177004](#) [622-0430](#) [622-3653LF](#) [63453-116](#) [636-1030](#) [636-1427](#) [636-3427](#) [636-4007](#) [641938-9](#) [65495-038](#) [65692-001LF](#) [65781-018](#)
[65781-047](#) [65817-010LF](#) [65817-015LF](#) [67095-007LF](#) [67601157](#) [68631-112](#) [699319-000](#) [70.362.1628.0](#) [70-4210](#) [70-4226B](#) [70-4853B](#) [707-](#)
[5028](#) [71.350.2428.0](#) [733-134](#) [733-162](#) [760-3052](#) [MHR-64-VUAL](#) [80.063.4001.1](#) [800-90-001-10-001000](#) [801-43-002-10-013000](#)
[801-43-006-10-002000](#) [803-43-024-10-001000](#) [803-93-012-10-001000](#) [8-1437020-4](#) [819-22-004-30-001101](#) [820-22-006-30-001101](#)
[820-22-008-30-001101](#) [821-22-002-10-001101](#)