

A		B		C		D		E	
REV.	DESCRIPTION				ECN NO.	NAME	DATE		

1

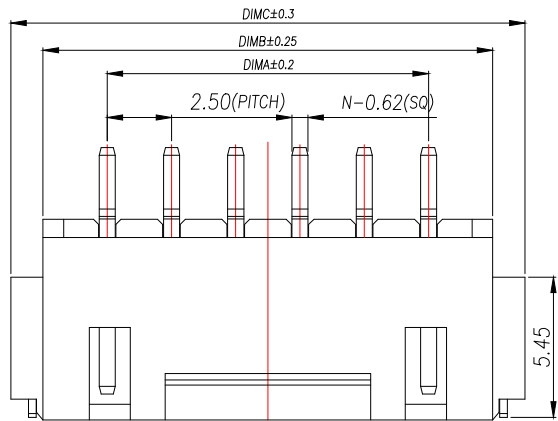

2

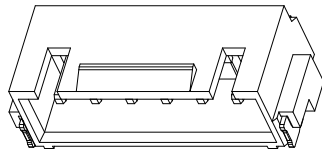

NOTES:

- Working temp:-25°C~85°C.
- Voltage rating:250V AV/DC(rms)
- Contact resistance:20mΩ max.
- Insulation resistance:1000MΩ min.
- Current rating:3A AV/DC
- Withstanding Voltage:1000V AC/minute
- Pin Retention Force:15N min.
- Housing material:LCP UL94-V0,Natural
- Terminal materl:Brass,
plating Ni 50u" min , plating Tin 100u"min.
- Solder tab material:Brass,
plating Ni 50u" min , plating Tin 100u"min.

3

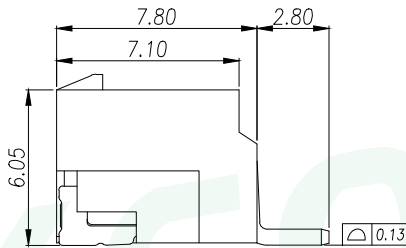
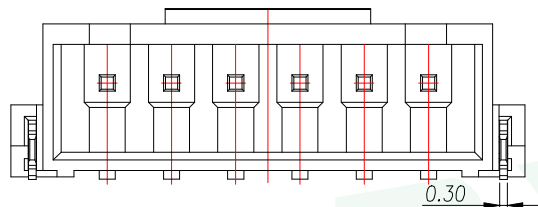

4

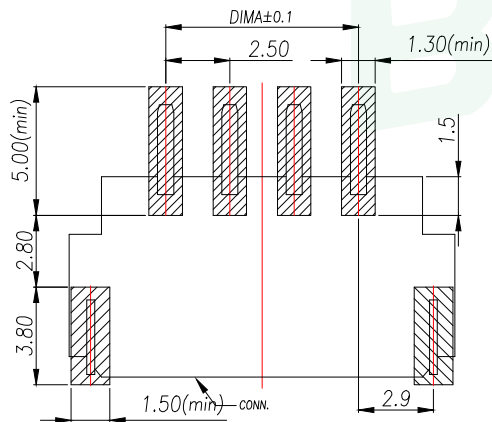

RECOMMENDED PCB LAYOUT TOP VIEW (TOLERANCE:±0.05)

SMT SOLDER AREA

5

PIN	NO.	Dim A	Dim B	Dim C
2	WF-1F254B2P	2.50	7.50	10.00
3	WF-1F254B3P	5.00	10.00	12.50
4	WF-1F254B4P	7.50	12.50	15.00
5	WF-1F254B5P	10.00	15.00	17.50
6	WF-1F254B6P	12.50	17.50	20.00
7	WF-1F254B7P	15.00	20.00	22.50
8	WF-1F254B8P	17.50	22.50	25.00
9	WF-1F254B9P	20.00	25.00	27.50
10	WF-1F254B10P	22.50	27.50	30.00
11	WF-1F254B11P	25.00	30.00	32.50
12	WF-1F254B12P	27.50	32.50	35.00
13	WF-1F254B13P	30.00	35.00	37.50
14	WF-1F254B14P	32.50	37.50	40.00
15	WF-1F254B15P	35.00	40.00	42.50
16	WF-1F254B16P	37.50	42.50	45.00

GENERAL TOLERANCE		DONGGUAN BAOXUN PRECISION TECHNOLOGY CO., LTD					
DIM. TOL.		TITLE: 线对板针座 XHB2.54 带扣 卧式贴片					
X		DWG. NO.: WF-1F254BNP				DRAWN: MAX	
X.X	±0.30	PART NO.: WF-1F254BNP				CHECKED: ELLA	
X.XX	±0.25	UNIT: mm				SCALE: none	
X.XXX	±0.15	SHEET: 1 of 1		DWG. SIZE: A4		LAYER: bxconn	
GENERAL ANGLE: ±3°		APPROVED: WILL					

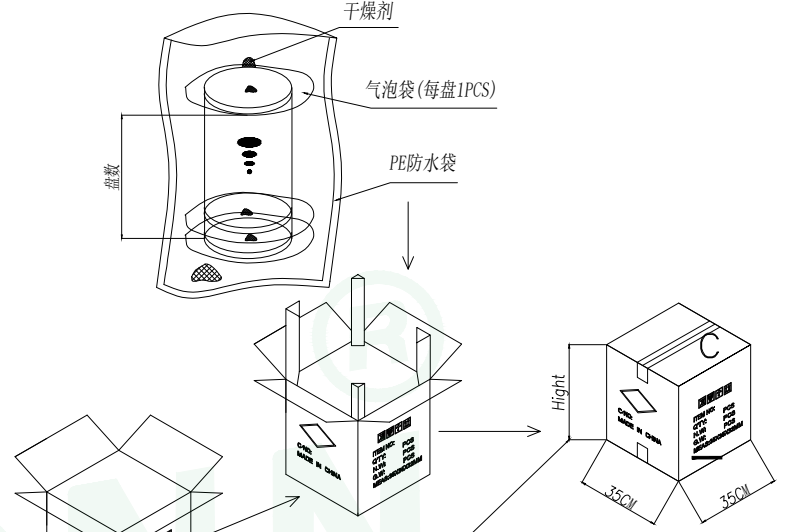
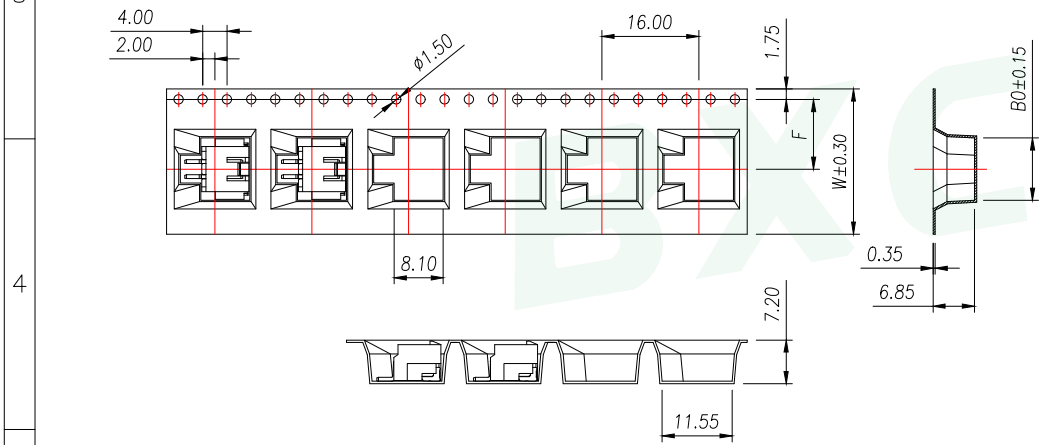
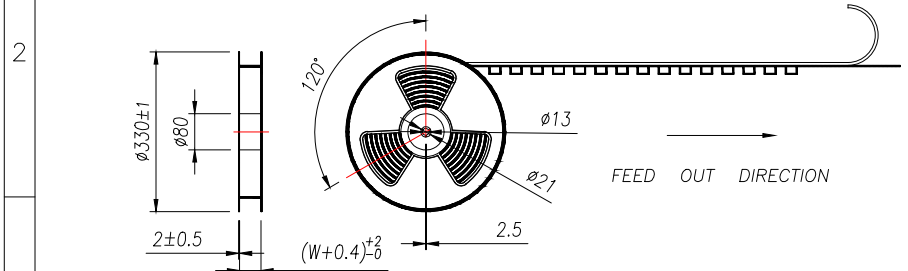
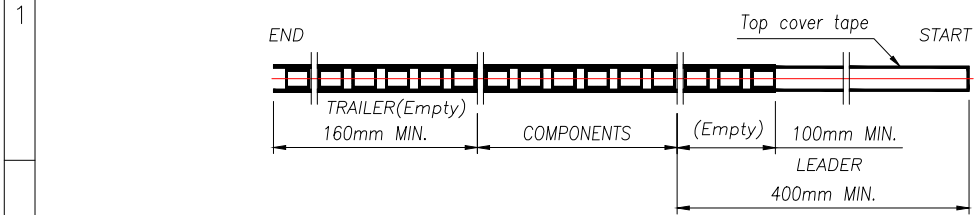

REV.	DESCRIPTION	ECN NO.	NAME	DATE



Carton Type	Small Siz	Medium	Standard
Hight(CM)	7.5	15	32

- NOTE:
- 1.10 SPROCKET HOLE PITCH CUMULATIVE TOLERANCE $\pm 0.2\text{mm}$.
 - 2.CARRIER CAMBER NOT TO EXCEED 1mm IN 100mm.
 - 3.ALL DIMENSIONS MEET EIA-481 REQUIREMENTS.
 - 4.MATERIAL: CLEAR ANTISTATIC PS, COLD SEALING.
 - 5.THICKNESS: $0.40 \pm 0.05\text{mm}$.
 - 6.PACKING LENGHT PER REEL: 10 METERS.
 - 7.COMPONENT LOAD PER REEL: 600 PCS.

PIN	NO.	Dim B0	Dim W	Dim F	PCS/RELL	RELL/CARTON	PCS/CARTON
2	WF-1F254B2P	10.30	24.00	11.50	600	10	6000
3	WF-1F254B3P	12.80					
4	WF-1F254B4P	15.30					

GENERAL TOLERANCE		DONGGUAN BAOXUN PRECISION TECHNOLOGY CO., LTD				 
DIM. TOL.		TITLE: 线对板针座 XHB2.54 带扣 卧式贴片				
X ± 0.30		DWG. NO.: WF-1F254BNP		DRAWN: MAX		
X.X ± 0.25		PART NO.: WF-1F254BNP		CHECKED: ELLA		
X.XX ± 0.15		UNIT: mm		SCALE: none	SHEET: 1 of 1	APPROVED: WILL
X.XXX ± 0.15		DWG. SIZE: A4		LAYER: bxconn		
GENERAL ANGLE: $\pm 3^\circ$						

A	B	C	D	E
---	---	---	---	---

REV.	DESCRIPTION	ECN NO.	NAME	DATE

1

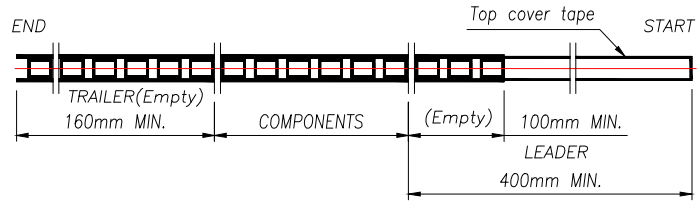

2

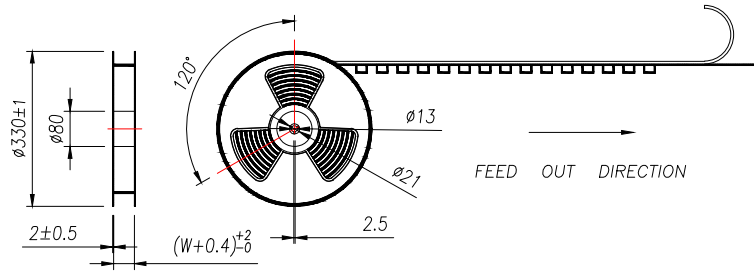

3

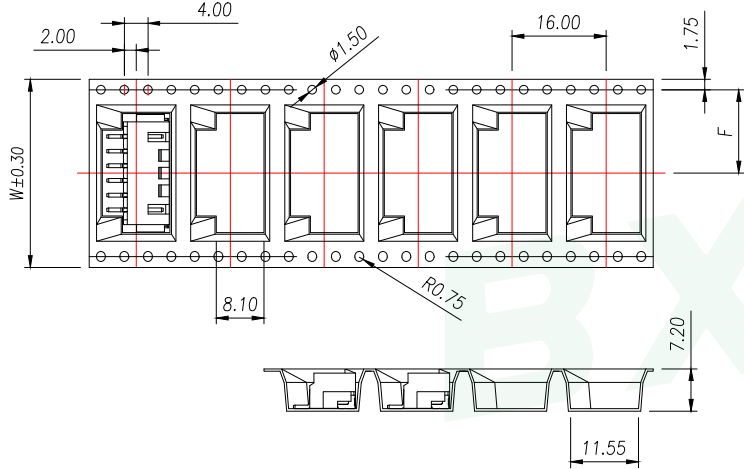

4

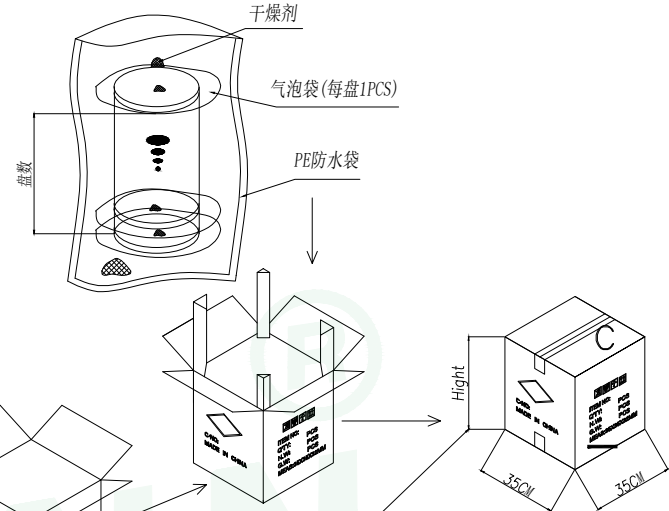
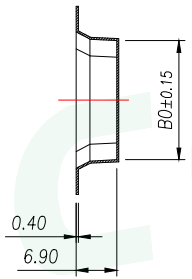



Carton Type	Small Siz	Medium	Standard
Hight(CM)	7.5	15	32

- NOTE:
1. SPROCKET HOLE PITCH CUMULATIVE TOLERANCE $\pm 0.2\text{mm}$.
 2. CARRIER CAMBER NOT TO EXCEED 1mm IN 100mm.
 3. ALL DIMENSIONS MEET EIA-481 REQUIREMENTS.
 4. MATERIAL: CLEAR ANTISTATIC PS, COLD SEALING.
 5. THICKNESS: $0.40 \pm 0.05\text{mm}$.
 6. PACKING LENGTH PER REEL: 10 METERS.
 7. COMPONENT LOAD PER REEL: 600 PCS.

5

PIN	NO.	Dim B0	Dim W	Dim F	PCS/RELL	RELL/CARTON	PCS/CARTON
5	WF-1F254B5P	17.80	32	14.2	600	8	4800
6	WF-1F254B6P	20.30					
7	WF-1F254B7P	22.80					
8	WF-1F254B8P	25.30	44	20.2		6	3600
9	WF-1F254B9P	27.80					
10	WF-1F254B10P	30.30					
11	WF-1F254B11P	32.80	56	26.2	5	3000	
12	WF-1F254B12P	35.30					

GENERAL TOLERANCE		DONGGUAN BAOXUN PRECISION TECHNOLOGY CO., LTD				 
DIM. TOL.		TITLE: 线对板针座 XHB2.54 带扣 卧式贴片				
X		DWG. NO.: WF-1F254BNP		DRAWN: MAX		
X.X	± 0.30	PART NO.: WF-1F254BNP		CHECKED: ELLA		
X.XX	± 0.25	UNIT: mm		APPROVED: WILL		
X.XXX	± 0.15	SCALE: none	SHEET: 1 of 1	DWG. SIZE: A4	LAYER: bxconn	
GENERAL ANGLE:	$\pm 3^\circ$					

X-ON Electronics

Largest Supplier of Electrical and Electronic Components

Click to view similar products for [Headers & Wire Housings](#) category:

Click to view products by [BXCONN](#) manufacturer:

Other Similar products are found below :

[0015917161](#) [0022155065](#) [57102-F02-18ULF](#) [58102-G61-06LF](#) [582553-1](#) [01.001.5753.1](#) [0050291907](#) [02.125.8002.8](#) [609-3404](#) [61062-3](#)
[CSU011177004](#) [622-0430](#) [622-3653LF](#) [63453-116](#) [636-1030](#) [636-1427](#) [636-3427](#) [636-4007](#) [641938-9](#) [65495-038](#) [65692-001LF](#) [65781-018](#)
[65781-047](#) [65817-010LF](#) [65817-015LF](#) [67095-007LF](#) [67601157](#) [68631-112](#) [699319-000](#) [70.362.1628.0](#) [70-4210](#) [70-4226B](#) [70-4853B](#) [707-](#)
[5028](#) [71.350.2428.0](#) [733-134](#) [733-162](#) [760-3052](#) [MHR-64-VUAL](#) [80.063.4001.1](#) [800-90-001-10-001000](#) [801-43-002-10-013000](#)
[801-43-006-10-002000](#) [803-43-024-10-001000](#) [803-93-012-10-001000](#) [8-1437020-4](#) [819-22-004-30-001101](#) [820-22-006-30-001101](#)
[820-22-008-30-001101](#) [821-22-002-10-001101](#)