



Elektronik

Das gesamte Sortiment an Schutzelementen für Stecker, Steckverbindungen, Anschlussbuchsen bietet einen optimalen Schutz vor Beschädigung, Verschmutzung und elektrostatischer Aufladung während des Transports und der Lagerung. Die Auswahl an ableitfähigen Kappen bietet eine kostengünstige Schutzlösung für hochwertige und teure elektronische Bauteile. Verschiedene Materialien und ein große Auswahl an Produktionsmöglichkeiten gewähren eine Lieferung von Produkten, die speziell auf Ihre Anforderungen abgestimmt sind. ESD Schutzanforderungen und MIL/NAS Spezifikation inklusive.

electronics

Our full line of connector protection shields electrical ports and components from contaminants, damage and electrical charge during the shipping and storage process. The range of general and static production parts serve as low cost insurance for expensive electronics. With specialized materials, a vast range of molding capabilities and an in-house team of engineers, we can deliver solutions to meet ESD protection requirements and MIL/NAS specifications.

Caplugs bietet zusätzlich zu den gezeigten Standardschutzelemente eine Vielzahl von Sonderprodukten, bei denen teilweise die Werkzeuge schon vorhanden sind.

C Series Straight-Sided Utility Caps



C Series caps are straight-sided, thin-walled closures designed to protect threaded connectors. The flanged end allows for easy installation and removal in difficult to reach areas. This versatile design is ideal for a variety of threaded and non-threaded applications.

• Applicable specifications: NAS 831

Material: Low-Density Polyethylene **Color:** Red

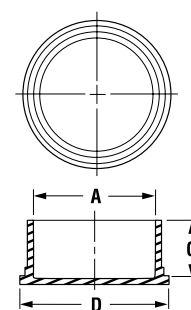

Straight-Sided Utility Caps C Series

Caplugs No.	To Cap Thread Size	Dimensions						Packaging	
		A		C		D		Carton Quantity	Mini Pak Quantity
		In	mm	In	mm	In	mm		
C-2	1/2	.476	12.09	.50	12.70	.72	18.29	7500	1500
C-6	5/8	.600	15.24	.50	12.70	.84	21.34	5000	1000
C-8	3/4	.724	18.39	.50	12.70	.94	23.88	5000	1000
C-10	7/8	.849	21.56	.50	12.70	1.09	27.69	3000	600
C-12	1	.974	24.74	.50	12.70	1.22	30.99	2500	500
C-14	1-1/8	1.097	27.86	.56	14.22	1.34	34.04	2500	500
C-16	1-3/16	1.168	29.67	.56	14.22	1.41	35.81	1500	300
C-18	1-1/4	1.221	31.01	.56	14.22	1.44	36.58	1500	300
C-20	1-3/8	1.344	34.14	.56	14.22	1.59	40.39	1500	300
C-22	1-7/16	1.408	35.76	.56	14.22	1.66	42.16	1000	200
C-24	1-1/2	1.467	37.26	.56	14.22	1.69	42.93	1000	200
C-26	1-3/4	1.716	43.59	.56	14.22	2.00	50.80	1000	200
C-28	2	1.964	49.89	.62	15.75	2.22	56.39	500	100
C-30	2-1/4	2.210	56.13	.62	15.75	2.44	61.98	500	100
C-32	2-1/2	2.460	62.48	.62	15.75	2.69	68.33	500	100
C-34	2-3/4	2.730	69.34	.62	15.75	2.96	75.18	500	100
C-36	3	2.980	75.69	.62	15.75	3.22	81.79	500	100
C-38	4	3.922	99.62	1.00	25.40	4.19	106.43	250	50
C-40	5	4.900	124.46	1.25	31.75	5.12	130.05	300	60

EC Series Caps for Threaded Connectors



EC Series caps are designed to fit 36- and 68-pin Champ 050 series connectors and 50-pin Champ-type connectors.

• Can be installed over threads or cylindrical surfaces

• Applicable specifications: NAS 813, NAS 831

Material: Low-Density Polyethylene **Color:** Red

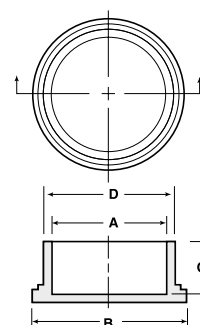

Caps for Threaded Connectors EC Series

Caplugs No.	To Cap Nominal Thread Size	Dimensions								Packaging	
		A		B		C		D		Carton Quantity	Mini Pak Quantity
		In	mm	In	mm	In	mm	In	mm		
EC-4	1/4	.246	6.25	.48	12.19	.50	12.70	.31	7.87	5000	1000
EC-M8	M8	.309	7.85	.55	13.97	.56	14.22	.37	9.40	5000	1000
EC-5	5/16	.308	7.82	.55	13.97	.56	14.22	.37	9.40	5000	1000
EC-6	3/8	.369	9.37	.62	15.75	.50	12.70	.43	10.92	5000	1000
EC-8	1/2	.480	12.19	.74	18.80	.50	12.70	.54	13.72	5000	1000
EC-9	9/16	.551	14.00	.78	19.81	.44	11.18	.61	15.49	5000	1000
EC-10	5/8	.605	15.37	.84	21.34	.50	12.70	.66	16.89	5000	1000
EC-12	3/4	.720	18.29	.97	24.64	.50	12.70	.77	19.68	5000	1000
EC-14	7/8	.850	20.83	1.13	28.70	.50	12.70	.90	22.99	5000	1000
EC-15	-	.930	23.62	1.20	30.47	.50	12.70	1.01	25.65	3000	600
EC-16	1	.973	24.71	1.22	30.99	.50	12.70	1.03	26.29	2500	500
EC-18	1-1/8	1.093	27.76	1.33	33.78	.56	14.22	1.15	29.35	2500	500
EC-19	1-3/16	1.188	30.18	1.40	35.56	.56	14.22	1.23	31.24	2500	500
EC-20	1-1/4	1.231	31.27	1.47	37.09	.56	14.22	1.30	33.05	2500	500
EC-22	1-3/8	1.340	34.04	1.59	40.39	.56	14.22	1.41	35.81	2500	500
EC-23	1-7/16	1.428	36.27	1.65	41.91	.56	14.22	1.46	37.08	1000	200
EC-24	1-1/2	1.463	37.16	1.70	43.18	.56	14.22	1.53	38.94	2500	500
EC-25	1-9/16	1.528	38.81	1.73	43.94	.48	12.19	1.59	40.39	2500	500
EC-26	1-5/8	1.613	40.97	1.91	48.51	.55	19.97	1.71	43.43	1000	200
EC-28	1-3/4	1.715	43.56	1.95	49.53	.56	14.22	1.79	45.47	1000	200
EC-32	2	1.965	49.91	2.22	56.39	.56	14.22	2.04	51.82	1000	200
EC-36	2-1/4	2.215	56.26	2.43	61.72	.60	15.24	2.29	58.17	1000	200
EC-40	2-1/2	2.456	62.38	2.68	68.07	.62	15.75	2.52	64.01	1000	200
EC-44	2-3/4	2.720	69.09	2.96	75.18	.60	15.24	2.81	71.42	500	100
EC-48	3	2.960	75.18	3.23	82.05	.60	15.24	3.05	77.47	500	100
EC-64	4	3.940	100.08	4.16	105.67	1.00	25.40	4.00	101.60	200	40
EC-80	5	4.944	125.58	5.12	130.05	1.25	31.75	5.00	127.00	150	30

SEC Series Static Dissipative Caps for Threaded Connectors



SEC Series static dissipative caps provide positive ESD and physical protection for all common sizes of threaded electrical and electronic connectors. Also suitable for protecting non-threaded, bayonet-type connectors.

- Available in other material and color options
- Applicable specifications: MS/AS 90376, SAE AS85049/138

Material: Static Dissipative Polyethylene **Color:** Pink

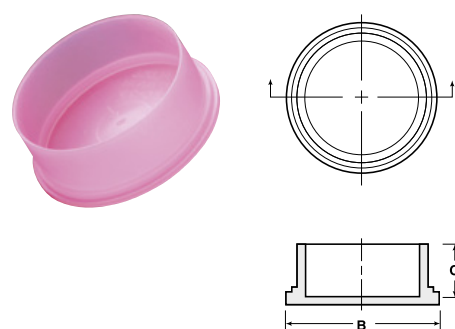

Static Dissipative Caps for Threaded Connectors SEC Series

Caplugs No.	To Cap Nominal Thread Size	Dimensions				Packaging	
		B		C		Carton Quantity	Mini Pak Quantity
		In	mm	In	mm		
SEC-4	1/4	.48	12.19	.50	12.70	5000	1000
SEC-5	5/16	.55	13.97	.56	14.22	5000	1000
SEC-6	3/8	.62	15.75	.50	12.70	5000	1000
SEC-8	1/2	.74	18.79	.50	12.70	5000	1000
SEC-9	9/16	.78	19.81	.44	11.18	5000	1000
SEC-10	5/8	.84	21.34	.50	12.70	5000	1000
SEC-12	3/4	.97	24.63	.50	12.70	5000	1000
SEC-14	7/8	1.12	28.44	.50	12.70	5000	1000
SEC-16	1	1.22	30.98	.50	12.70	2500	500
SEC-18	1-1/8	1.33	33.78	.56	14.22	2500	500
SEC-19	1-3/16	1.40	35.56	.56	14.22	2500	500
SEC-20	1-1/4	1.46	37.09	.56	14.22	2500	500
SEC-22	1-3/8	1.59	40.39	.56	14.22	2500	500
SEC-23	1-7/16	1.65	41.91	.56	14.22	1000	200
SEC-24	1-1/2	1.70	43.18	.56	14.22	2500	500
SEC-25	1-9/16	1.73	43.94	.48	12.19	2500	500
SEC-26	1-5/8	1.91	48.51	.55	13.97	1000	200
SEC-28	1-3/4	1.95	49.53	.56	14.22	1000	200
SEC-32	2	2.20	55.88	.56	14.22	1000	200
SEC-36	2-1/4	2.43	61.72	.60	15.24	1000	200
SEC-40	2-1/2	2.68	68.07	.62	15.75	1000	200
SEC-44	2-3/4	2.96	75.19	.60	15.24	500	100
SEC-48	3	3.22	81.78	.60	15.24	500	100

CEC Series Conductive Caps for Threaded and Non-Threaded Connectors



CEC Series conductive caps are for all common sizes of threaded electrical and electronic connectors. Also suitable for protecting non-threaded, bayonet-type connectors. In addition to dissipating electrostatic charges, they provide an electrical shield over the end of the connector.

- Applicable specifications: MS/AS 90376, SAE AS85049/138, NASM5501/31

Material: Conductive Polyethylene Copolymer (EVA)
Color: Black

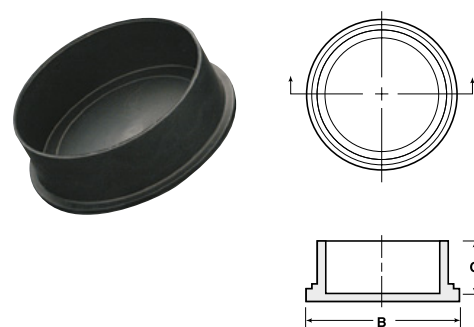

Conductive Caps for Threaded and Non-Threaded Connectors CEC Series

Caplugs No.	To Cap Nominal Thread Size	Dimensions				Packaging	
		B		C		Carton Quantity	Mini Pak Quantity
		In	mm	In	mm		
CEC-04	1/4	.48	12.19	.49	12.45	5000	1000
CEC-05	5/16	.56	14.22	.56	14.22	5000	1000
CEC-06	3/8	.62	15.75	.51	12.95	5000	1000
CEC-08	1/2	.73	18.54	.50	12.70	5000	1000
CEC-10	5/8	.84	21.34	.50	12.70	5000	1000
CEC-12	3/4	.97	24.64	.50	12.70	5000	1000
CEC-14	7/8	1.15	29.21	.50	12.70	5000	1000
CEC-16	1	1.23	31.24	.50	12.70	2500	500
CEC-18	1-1/8	1.36	34.55	.56	14.22	2500	500
CEC-19	1-3/16	1.42	36.07	.50	12.70	2500	500
CEC-20	1-1/4	1.48	37.59	.57	14.48	2500	500
CEC-22	1-3/8	1.63	41.40	.57	14.48	2500	500
CEC-23	1-7/16	1.68	42.67	.56	14.22	1000	200
CEC-24	1-1/2	1.70	43.18	.56	14.22	2500	500
CEC-25	1-9/16	1.75	44.45	.50	12.70	2500	500
CEC-26	1-5/8	1.93	49.02	.56	14.22	1000	200
CEC-28	1-3/4	2.01	51.06	.56	14.22	1000	200
CEC-29	1-13/16	2.03	51.56	.56	14.22	1000	200
CEC-32	2	2.23	56.64	.55	13.97	1000	200
CEC-36	2-1/4	2.46	62.49	.62	15.75	1000	200
CEC-40	2-1/2	2.70	68.58	.62	15.75	1000	200
CEC-44	2-3/4	2.99	75.95	.62	15.75	500	100
CEC-48	3	3.27	83.06	.60	15.24	500	100
CEC-64	4	4.19	106.43	1.01	25.66	200	40

MSC Series

ESD Connector Caps



MSC Series ESD connector caps are manufactured of an ICP (inherently conductive polymer) compound. This non-sloughing material will not mark or crayon when rubbed briskly against a hard, flat, laminated surface.

- Commonly used for military and aerospace applications to meet M5501/31 requirements

Material: ICP Compound **Color:** Black

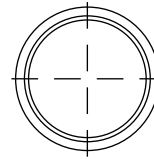
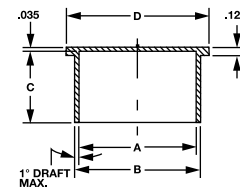

ESD Connector Caps MSC Series

Caplugs No.	Shell Size	NAS M 5501/31	Dimensions								Standard Package Pieces	Red E-Pak Pieces
			A		B		C		D			
			In	mm	In	mm	In	mm	In	mm		
MSC-4Q4	4	250	.245	6.22	.305	7.75	.50	12.70	.43	10.92	5000	1000
MSC-5Q3	5	313	.305	7.75	.365	9.27	.50	12.70	.50	12.70	5000	1000
MSC-6Q4	6	375	.368	9.35	.438	11.13	.50	12.70	.62	15.75	5000	1000
MSC-8RQ3	8	480	.480	12.19	.540	13.72	.50	12.70	.74	18.80	9000	1800
MSC-9Q3	9	500	.542	13.77	.602	15.29	.50	12.70	.78	19.81	5000	1000
MSC-10RQ3	10	605	.605	15.37	.665	16.89	.50	12.70	.84	21.34	6000	1200
MSC-12RQ3	12	720	.720	18.29	.775	19.69	.50	12.70	.97	24.64	5000	1000
MSC-14RQ3	14	850	.850	21.59	.905	22.99	.50	12.70	1.12	28.45	3500	700
MSC-16RQ3	16	973	.973	24.71	1.035	26.29	.50	12.70	1.22	30.99	2500	500
MSC-18RQ3	18	1093	1.093	27.76	1.155	29.34	.56	14.22	1.33	33.78	2000	400
MSC-19Q3	19	1125	1.168	29.67	1.238	31.45	.56	14.22	1.43	36.32	1500	300
MSC-20RQ4	20	1231	1.231	31.27	1.301	33.05	.56	14.22	1.46	37.08	2500	500
MSC-22RQ4	22	1340	1.340	34.04	1.410	35.81	.56	14.22	1.59	40.39	1500	300
MSC-23Q3	23	-	1.408	35.76	1.478	37.54	.56	14.22	1.65	41.91	1000	200
MSC-24RQ3	24	1463	1.463	37.16	1.533	38.94	.56	14.22	1.70	43.18	1500	300
MSC-25Q3	25	-	1.536	39.01	1.606	40.79	.56	14.22	1.78	45.21	1500	300
MSC-26Q3	26	-	1.590	40.39	1.660	42.16	.56	14.22	1.81	45.97	1000	200
MSC-28R-1Q3	28	1715	1.715	43.56	1.790	45.47	.56	14.22	1.95	49.53	1000	200
MSC-32R-1Q3	32	1965	1.965	49.91	2.040	51.82	.56	14.22	2.22	56.39	900	180
MSC-36R-1Q3	36	2215	2.125	53.98	2.290	58.17	.60	15.24	2.44	61.98	500	100
MSC-40R-1Q3	40	2440	2.440	61.98	2.530	64.26	.60	15.24	2.66	67.56	500	100
MSC-44R-1Q3	44	2720	2.270	57.66	2.812	71.42	.60	15.24	2.96	75.18	500	100
MSC-48R-1Q3	48	2960	2.960	75.18	3.050	77.47	.60	15.24	3.22	81.79	500	100

MSC Series

ESD Connector Plugs



MSC Series ESD connector plugs are manufactured of an ICP (inherently conductive polymer) compound. This non-sloughing material will not mark or crayon when rubbed briskly against a hard, flat, laminated surface.

- Commonly used for military and aerospace applications to meet M5501/31 requirements

Material: ICP Compound **Color:** Black

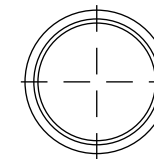
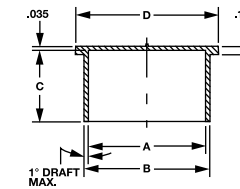

ESD Connector Plugs MSC Series

Caplugs No.	NAS M 5501/31	Dimensions								Standard Package Pieces	Red E-Pak Pieces
		A		B		C		D			
		In	mm	In	mm	In	mm	In	mm		
MSC-8YQ3	413	.413	10.49	.483	12.27	.62	15.75	.67	17.02	10000	2000
MSC-10YQ3	530	.530	13.46	.595	15.11	.62	15.75	.75	19.05	7000	1400
MSC-12YQ3	655	.655	16.64	.715	18.16	.62	15.75	.86	21.84	5000	1000
MSC-14YQ3	785	.785	19.94	.845	21.46	.62	15.75	1.03	26.16	4500	900
MSC-16YQ3	893	.893	22.68	.963	24.46	.62	15.75	1.12	28.45	3500	700
MSC-18YQ3	1028	1.028	26.11	1.088	27.64	.62	15.75	1.25	31.75	3000	600
MSC-20YQ3	1150	1.150	29.21	1.215	30.86	.62	15.75	1.41	35.81	2500	500
MSC-22YQ3	1270	1.270	32.26	1.340	34.04	.62	15.75	1.50	38.10	2000	400
MSC-24YQ3	1390	1.390	35.31	1.460	37.08	.62	15.75	1.64	41.66	1500	300
MSC-25YQ3	1540	1.540	39.12	1.580	40.13	.62	15.75	1.81	45.97	1250	250
MSC-28Y-1Q3	1645	1.648	41.86	1.718	43.64	.62	15.75	1.88	47.75	1000	200
MSC-32YQ3	1890	1.890	48.01	1.970	50.04	.62	15.75	2.12	53.85	900	180
MSC-36YQ3	2140	2.140	54.36	2.210	56.13	.62	15.75	2.34	59.44	500	100
MSC-40Y-1Q3	2380	2.380	60.45	2.450	62.23	.62	15.75	2.60	66.04	500	100
MSC-44Y-1Q3	2630	2.630	66.80	2.700	68.58	.62	15.75	2.88	73.15	500	100
MSC-48Y-1Q3	2880	2.880	73.15	2.950	74.93	.62	15.75	3.12	79.25	500	100

DS Series

ESD D-Subminiature Caps



DS Series non-sloughing caps are designed to meet the stringent requirements of M 5501/32. Manufactured of an inherently conductive polymer compound, they have a volume resistance of 10.5 ohms and include the required electrostatic discharge symbol per ASTM D 5445, Symbol 28.

Material: ICP Compound **Color:** Black

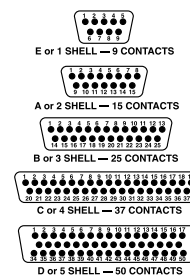

ESD D-Subminiature Caps DS Series

Caplugs No.	Standard No. of Contacts	Contact Types	NAS M 5501/32 Dash No.	Carton Quantity	Mini Pak Quantity
DS-10Q4	9	Socket	9S	5000	1000
DS-11Q4	9	Pin	9P	5000	1000
DS-20Q4	15	Socket	15S	5000	1000
DS-21Q4	15	Pin	15P	5000	1000
DS-30Q4	25	Socket	25S	5000	1000
DS-31Q4	25	Pin	25P	5000	1000
DS-40Q4	37	Socket	37S	3000	600
DS-41Q4	37	Pin	37P	3000	600
DS-50Q4	50	Socket	50P	3000	600
DS-51Q4	50	Pin	50P	3000	600

DCC Series

Static Dissipative & Conductive Protectors for D-Subminiature Connectors



DCC Series static dissipative and conductive protectors for D-subminiature connectors provide electrostatic discharge protection of rectangular input/output-type connectors. Molded with an integral flange to enable easy application and removal, DCC Series are available in either a black conductive polyethylene copolymer or pink static dissipative ethylene vinyl acetate.

Material: Static Dissipative Ethylene Vinyl Acetate or Conductive Polyethylene Copolymer (EVA) **Color:** Pink or Black

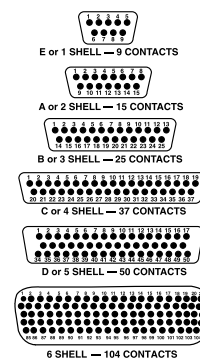

Static Dissipative & Conductive Protectors for D-Subminiature Connectors DCC Series

Caplugs No.	Dimensions		Packaging	
	Standard No. of Contacts	Contact Types	Carton Quantity	Mini Pak Quantity
DCC-01	9	Socket	5000	1000
DCC-11	9	Pin	5000	1000
DCC-02	15	Socket	5000	1000
DCC-12	15	Pin	5000	1000
DCC-03	25	Socket	5000	1000
DCC-13	25	Pin	5000	1000
DCC-04	37	Socket	5000	1000
DCC-14	37	Pin	5000	1000
DCC-05	50	Socket	4000	800
DCC-15	50	Pin	4000	800
DCC-08	104	Socket	5000	1000
DCC-18	104	Pin	5000	1000

DCF Series

Static Dissipative & Conductive Protectors for D-Subminiature Flared Shells



DCF Series static dissipative and conductive protectors for D-subminiature flared shells protect electrical connectors from dust and impact damage. DCF-06, DCF-07 and DCF-08 types are designed to fit D-subminiature power connectors with flared shells. DCF Series are available in a black conductive polyethylene copolymer or pink static dissipative ethylene vinyl acetate.

Material: Static Dissipative Ethylene Vinyl Acetate or Conductive Polyethylene Copolymer (EVA) **Color:** Pink or Black

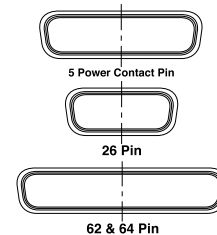

Static Dissipative & Conductive Protectors for D-Subminiature Flared Shells DCF Series

Caplugs No.	Dimensions		Packaging	
	Standard No. of Contacts	Contact Types	Carton Quantity	Mini Pak Quantity
DCF-06	26	Pin	1000	200
DCF-07	5	Power Contact Pin	3000	600
DCF-08	62 & 64	Pin	1000	200
DCF-11	9	Pin	5000	1000

EMC Series

Static Dissipative & Conductive Protectors for Electro Miniature Connectors

EMC Series caps are designed to fit 36- and 68-pin Champ 050 series connectors and 50-pin Champ-type connectors.

Material: Static Dissipative Ethylene Vinyl Acetate or Conductive Polyethylene Copolymer (EVA) **Color:** Pink or Black

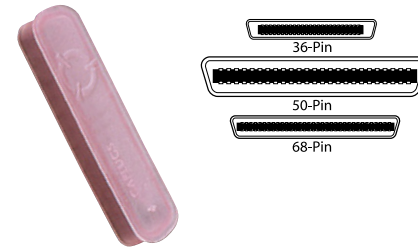

Static Dissipative & Conductive Protectors for Electro Miniature Connectors EMC Series

Caplugs No.	Dimensions		Packaging	
	Standard No. of Contacts	Contact Types	Carton Quantity	Mini Pak Quantity
EMC-36	36	Receptacle	5000	1000
EMC-50	50	Receptacle	1000	200
EMC-68	68	Receptacle	5000	1000

MDC Series

Static Dissipative & Conductive Protectors for Micro-D Connectors

MDC Series protectors are designed to fit Micro-DC connectors. Available in a black conductive polyethylene copolymer or pink static dissipative ethylene vinyl acetate.

Material: Static Dissipative Ethylene Vinyl Acetate or Conductive Polyethylene Copolymer (EVA) **Color:** Pink or Black

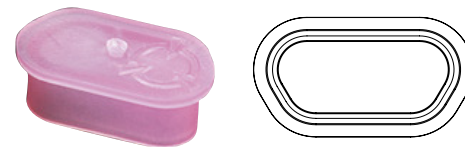

Static Dissipative & Conductive Protectors for Micro-D Connectors MDC Series

Caplugs No.	Dimensions		Packaging	
	Standard No. of Contacts	Contact Types	Carton Quantity	Mini Pak Quantity
MDC-15	26	Socket	3000	600
MDC-9P	9	Pin	5000	n/a

DP Series

Conductive Caps/Plugs

DP Series caps/plugs are designed to dissipate electrostatic charges and provide mechanical protection and electrical shielding for ITT Cannon-style connectors commonly used for aerospace and military applications.

Material: Conductive Polyethylene Copolymer (EVA) **Color:** Black

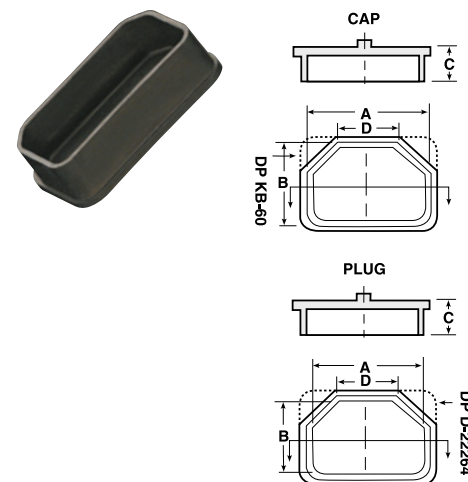

Conductive Caps/Plugs DP Series

Caplugs No.	Dimensions								Packaging	
	A		B		C		D		Carton Quantity	Mini Pak Quantity
	In	mm	In	mm	In	mm	In	mm		
DP-XA-59	1.611	40.92	.981	24.92	.67	17.02	1.14	28.96	500	100
DP-KB-60	3.409	86.58	1.011	25.67	.58	14.73	-	-	200	40
DP-XB-60	1.656	42.06	1.005	25.52	.34	8.64	1.16	29.46	500	100
DP-D-22264	2.422	61.52	1.425	36.19	.76	19.30	-	-	200	40
DP-A-60	1.430	36.32	.780	19.81	.40	10.16	1.09	27.68	500	100

CBC Series

Coaxial Cable Connector Caps



CBC Series tethered caps are used to protect cable connectors during packaging and shipping.

- Snaps securely to keep dirt and moisture out
- Fits 3/8" diameter

Material: Low-Density Polyethylene **Color:** Black

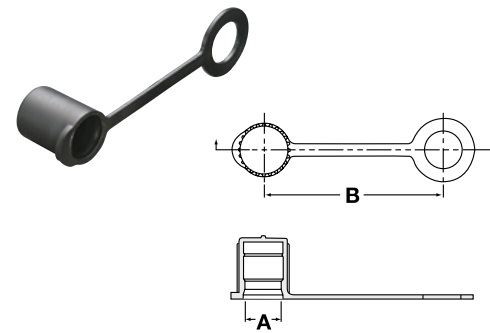

Coaxial Cable Connector Caps CBC Series

Caplugs No.	To Fit Thread Size	Dimensions				Packaging	
		A		B		Carton Quantity	Mini Pak Quantity
		In	mm	In	mm		
CBC-6	3/8	.360	9.14	1.75	44.45	5000	1000

EP Series

Plugs for Threaded Connectors



EP Series plugs for threaded connectors are designed for easy application and removal in areas not readily accessible. They can be installed to fit threaded or smooth cylindrical surfaces.

- Applicable specifications: NAS 837, NAS 820, MS/AS 90376

Material: Low-Density Polyethylene **Color:** Yellow

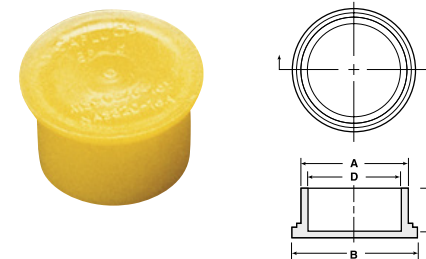

Plugs for Threaded Connectors EP Series

Caplugs No.	To Plug Nominal Thread Size	Dimensions								Packaging	
		A		B		C		D		Carton Quantity	Mini Pak Quantity
		In	mm	In	mm	In	mm	In	mm		
EP-8	1/2 - 28	.483	12.27	.67	17.02	.63	16.00	.41	10.41	5000	1000
EP-10	5/8 - 24	.595	15.11	.75	19.05	.63	16.00	.53	13.46	5000	1000
EP-12	3/4 - 20	.715	18.16	.86	21.84	.63	16.00	.66	16.76	5000	1000
EP-14	7/8 - 20	.845	21.46	1.03	26.16	.63	16.00	.79	20.07	5000	1000
EP-16	1 - 20	.963	24.46	1.12	28.45	.63	16.00	.89	22.61	2500	500
EP-18	1-1/8 - 18	1.088	27.64	1.25	31.75	.63	16.00	1.03	26.16	2500	500
EP-20	1-1/4 - 18	1.215	30.86	1.40	35.56	.63	16.00	1.15	29.21	2500	500
EP-22	1-3/8 - 18	1.340	34.04	1.50	38.10	.63	16.00	1.27	32.26	2500	500
EP-24	1-1/2 - 18	1.460	37.08	1.64	41.66	.63	16.00	1.39	35.31	1000	200
EP-25	1-5/8 - 16	1.580	40.13	1.81	45.98	.63	16.00	1.54	39.12	1000	200
EP-28	1-3/4 - 18	1.718	43.64	1.87	47.49	.63	16.00	1.68	42.67	1000	200
EP-32	2 - 18	1.970	50.04	2.13	54.10	.63	16.00	1.89	48.01	1000	200
EP-36	2-1/4 - 16	2.210	56.13	2.34	59.44	.63	16.00	2.14	54.36	1000	200
EP-40	2-1/2 - 16	2.450	62.23	2.60	66.04	.63	16.00	2.38	60.45	1000	200
EP-44	2-3/4 - 16	2.700	68.58	2.88	73.15	.63	16.00	2.63	66.80	500	100
EP-48	3 - 16	2.950	74.93	3.12	79.25	.63	16.00	2.88	73.15	500	100

USB Series

Cap & Plug for USB Connectors

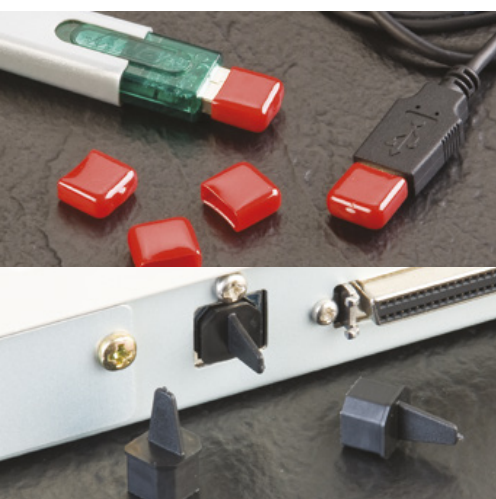

Cap for USB Type A Cable Ends

USB Type A protective caps slip on quickly and easily while maintaining a snug fit to protect USB Type A cable ends and flash drives from dust, moisture, and contaminants.

- Convenient pull-tab for quick and easy removal
- Non-conductive

Material: Vinyl **Color:** Red

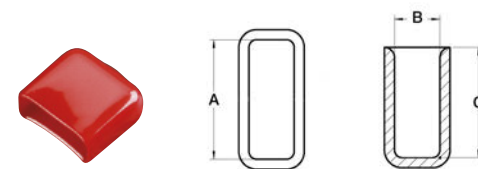

Plug for Type B Female Port

USB Series plugs protect type B USB female ports from dust, moisture, and contaminants.

Material: Low-Density Polyethylene **Color:** Black

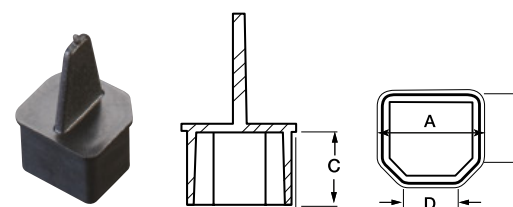

Cap and Plug for USB Connectors USB Series

Caplugs No.	Dimensions								Packaging		
	A		B		C		D		Carton Quantity	Mini Pak Quantity	Micro Pak Quantity
	In	mm	In	mm	In	mm	In	mm			
USB-A-CAP	.48	12.19	.18	4.57	.438	11.13	n/a	n/a	1000	200	40
USB-B	.326	8.28	.326	8.28	.25	6.35	.20	5.08	5000	1000	200

E Series Utility Plugs



E Series utility plugs are designed with straight sides and thin walls to protect threaded connectors. The flanged end provides easy removal in hard-to-reach areas. With such a versatile design, these plugs are ideal for a variety of threaded and non-threaded applications.

Material: Low-Density Polyethylene **Color:** Yellow

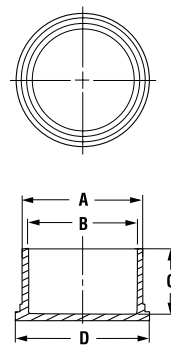

Utility Plugs E Series

Caplugs No.	To Fit Thread Size	Dimensions								Packaging	
		A		B		C		D		Carton Quantity	Mini Pak Quantity
		In	mm	In	mm	In	mm	In	mm		
E-2	1/2	.486	12.34	.426	10.82	.63	16.00	.66	16.76	10000	2000
E-6	5/8	.607	15.42	.547	13.89	.63	16.00	.75	19.05	6500	1300
E-10	3/4	.724	18.39	.664	16.87	.63	16.00	.84	21.34	5000	1000
E-12	7/8	.850	21.59	.790	20.07	.63	16.00	1.00	25.40	4500	900
E-14	1	.977	24.82	.917	23.29	.63	16.00	1.16	29.46	3500	700
E-16	1-1/8	1.098	27.89	1.038	26.37	.63	16.00	1.25	31.75	2500	500
E-18	1-1/4	1.223	31.06	1.163	29.54	.63	16.00	1.38	35.05	1500	300
E-20	1-3/8	1.349	34.26	1.289	32.74	.63	16.00	1.50	38.10	1500	300
E-22	1-1/2	1.474	37.44	1.414	35.92	.63	16.00	1.62	41.15	1000	200
E-24	1-3/4	1.726	43.84	1.666	42.32	.63	16.00	1.88	47.75	1000	200
E-26	2	1.977	50.22	1.917	48.69	.63	16.00	2.09	53.09	1000	200
E-28	2-1/4	2.217	56.31	2.157	54.79	.63	16.00	2.38	60.45	500	100
E-30	2-1/2	2.418	61.42	2.358	59.89	.63	16.00	2.62	66.55	500	100

SEP Series Static Dissipative Plugs for Threaded Connectors



SEP Series static dissipative plugs are designed to fit inside both threaded and non-threaded bayonet-type connectors.

• Applicable specifications:
SAE AS85049/138, MS/AS 90376

Material: Static Dissipative Polyethylene **Color:** Pink

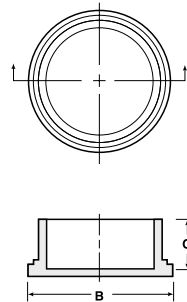

Static Dissipative Plugs for Threaded Connectors SEP Series

Caplugs No.	To Plug Nominal Thread Size	Dimensions				Packaging	
		B		C		Carton Quantity	Mini Pak Quantity
		In	mm	In	mm		
SEP-8	1/2 - 28	.67	17.01	.62	15.74	5000	1000
SEP-10	5/8 - 24	.75	19.05	.62	15.74	5000	1000
SEP-12	3/4 - 20	.86	21.84	.62	15.74	5000	1000
SEP-14	7/8 - 20	1.03	25.16	.62	15.74	5000	1000
SEP-16	1 - 20	1.12	28.44	.62	15.74	2500	500
SEP-18	1-1/8 - 18	1.25	31.75	.62	15.74	2500	500
SEP-20	1-1/4 - 18	1.40	35.56	.62	15.74	2500	500
SEP-22	1-3/8 - 18	1.50	38.10	.62	15.74	2500	500
SEP-24	1-1/2 - 18	1.64	41.65	.62	15.74	1000	200
SEP-25	1-9/16 - 18	1.81	45.98	.62	15.74	1000	200
SEP-28	1-3/4 - 18	1.87	47.49	.62	15.74	1000	200
SEP-32	2 - 18	2.13	54.10	.62	15.74	1000	200
SEP-36	2-1/4 - 16	2.34	59.44	.62	15.74	1000	200
SEP-40	2-1/2 - 16	2.60	66.04	.62	15.74	1000	200
SEP-44	2-3/4 - 16	2.88	73.15	.62	15.74	500	100
SEP-48	3 - 16	3.12	79.25	.62	15.74	500	100

RJ Series RJ45 Ethernet Jack Protective Plug

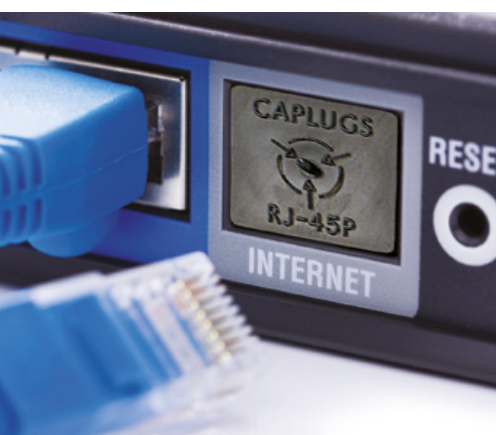

RJ Series conductive polyethylene plugs are designed to protect RJ45-type connecting jacks for computers and network equipment. These plugs are ideal to protect ports from dust or moisture during assembly and shipment.

Material: Conductive Polyethylene Copolymer (EVA)
Color: Black

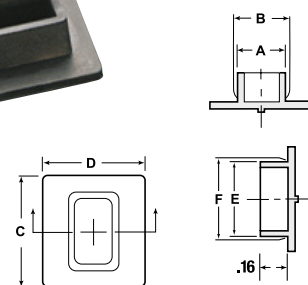

RJ45 Ethernet Jack Protective Plug RJ Series

Caplugs No.	Dimensions										Packaging			
	A		B		C		D		E		F		Carton Quantity	Mini Pak Quantity
	In	mm	In	mm	In	mm	In	mm	In	mm	In	mm		
RJ-45P	.27	6.86	.28	7.11	.62	15.75	.57	14.48	.435	11.05	.445	11.30	2500	500

CEP Series

Conductive Plugs for Threaded Connectors



Designed to plug the more popular sizes of both threaded and non-threaded, bayonet type electrical and electronic connectors, CEP Series Conductive Plugs provide electrical shielding as well as mechanical protection.

- Applicable specifications: SAE AS85049/138

Material: Conductive Polyethylene Copolymer (EVA)

Color: Black

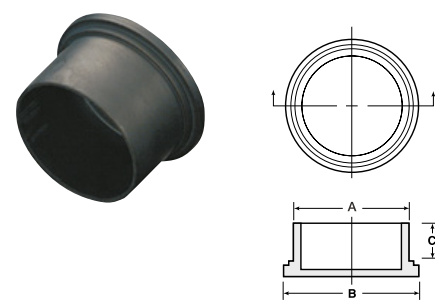

Conductive Plugs for Threaded Connectors CEP Series

Caplugs No.	To Plug Nominal Thread Size	Dimensions						Packaging	
		A		B		C		Carton Quantity	Mini Pak Quantity
		In	mm	In	mm	In	mm		
CEP-08	1/2 - 28	.483	12.27	.67	17.02	.55	13.97	5000	1000
CEP-10	5/8 - 24	.601	15.27	.76	19.30	.56	14.22	5000	1000
CEP-12	3/4 - 20	.730	18.54	.88	22.35	.56	14.22	5000	1000
CEP-14	7/8 - 20	.852	21.64	1.02	25.91	.56	14.22	5000	1000
CEP-16	1 - 20	.976	24.79	1.16	29.47	.55	13.97	2500	500
CEP-18	1-1/8 - 18	1.091	27.71	1.25	31.75	.54	13.72	2500	500
CEP-20	1-1/4 - 18	1.231	31.27	1.45	36.83	.55	13.97	2500	500
CEP-22	1-3/8 - 18	1.340	34.04	1.52	38.61	.54	13.72	2500	500
CEP-24	1-1/2 - 18	1.463	37.16	1.67	42.42	.55	13.97	1000	200
CEP-25	1-9/16 - 18	1.580	40.13	1.81	45.97	.62	15.75	1250	250
CEP-28	1-3/4 - 18	1.727	43.87	1.90	48.26	.55	13.97	1000	200
CEP-29	1-13/16 - 16	1.756	44.60	1.94	49.28	.56	14.22	1000	200
CEP-32	2 - 18	1.984	50.39	2.16	58.87	.54	13.72	1000	200
CEP-36	2-1/4 - 16	2.221	56.41	2.39	60.71	.55	13.97	1000	200
CEP-40	2-1/2 - 16	2.460	62.48	2.67	67.82	.56	14.22	1000	200
CEP-44	2-3/4 - 16	2.683	68.14	2.88	73.15	.56	14.22	500	100
CEP-48	3 - 16	2.944	74.78	3.12	79.25	.54	13.72	500	100

CEG Series

Conductive Edge Liners

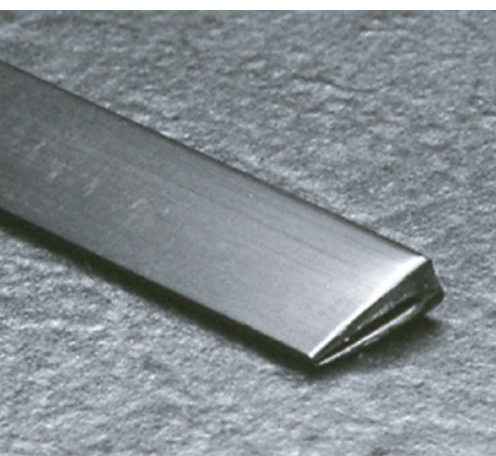

CEG Series conductive edge liners securely grip each contact of edgeboard connectors and are also used for single in-line devices. These extruded conductive edge liners are the most cost-effective way to provide both ESD and physical protection for circuit boards and subassemblies.

Material: Conductive Polyethylene Copolymer (EVA)

Color: Black

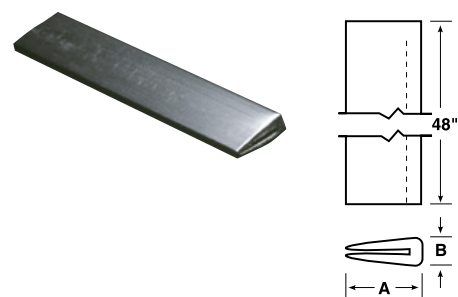

Conductive Edge Liners CEG Series

Caplugs No.	Metal Thickness		Dimensions				Packaging	
	In	mm	A		B		No. of 48" Length Pieces	Mini Pak Quantity
	In	mm	In	mm	In	mm		
CEG-23-1	.03	.76	.48	12.19	.17	4.32	100	20
CEG-23-2	.06	1.52	.48	12.19	.20	5.08	100	20
CEG-23-2N	.06	1.52	.28	7.11	.20	5.08	150	30

IEC Series

Plugs for Female Connectors



IEC Series non-conductive plugs keep female connectors free of dust, moisture and contaminants during transit and storage.

- Inexpensive
- Flanged end offers easy installation and removal
- Available with a tab (IEC-14-TAB)

Material: Low-Density Polyethylene or PVC **Color:** Black

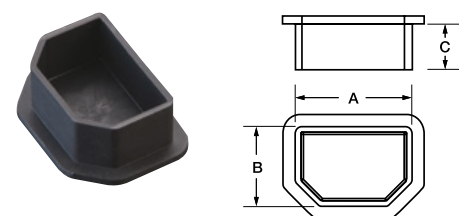

Plugs for Female Connectors IEC Series

Caplugs No.	Dimensions						Packaging	
	A		B		C		Carton Quantity	Mini Pak Quantity
	In	mm	In	mm	In	mm		
IEC-14	.960	24.38	.660	16.76	.380	9.65	4000	800
IEC-14-TAB	.960	24.38	.660	16.76	.380	9.65	2500	n/a

AS138 Series

Electrical Connector Dust Caps

AS138 Series electrical connector dust caps protect circular electrical connectors. This part is the only line of caps in the industry that meets the new SAE Aerospace specification AS85049/138.

- Tooled and engraved in full compliance with AS85049/138 and does not reference any other specifications
- Engraving includes the specification number, dash number, material code and the Caplugs part number for easy and positive identification
- Includes proper ESD Symbol as per the specification.
- Parts are listed in ascending order in relation to the dash number and are repeated for each material code (A, B, and C).
- Applicable specifications: SAE AS85049/138

Material:

A = Low-Density Polyethylene **Color:** Per specification

B = Electrostatic Dissipative **Color:** Black

C = Conductive **Color:** Black

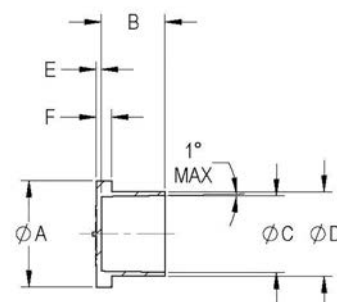

Electrical Connector Dust Caps (cont.) AS138 Series

Caplugs No.	Dimensions										Packaging		
	A		B		C		D		E		Carton Quantity	Micro Pak Quantity	Mini Pak Quantity
	In	mm	In	mm	In	mm	In	mm	In	mm			
AS138-24A	0.970	24.638	0.500	12.700	0.720	18.288	0.775	19.685	0.040	1.016	5000	1000	200
AS138-24B	0.970	24.638	0.500	12.700	0.720	18.288	0.775	19.685	0.040	1.016	5000	1000	200
AS138-24C	0.970	24.638	0.500	12.700	0.720	18.288	0.775	19.685	0.040	1.016	5000	1000	200
AS138-26A	1.031	26.187	0.625	15.875	0.785	19.939	0.845	21.463	0.045	1.143	4500	900	200
AS138-26B	1.031	26.187	0.625	15.875	0.785	19.939	0.845	21.463	0.045	1.143	4500	900	200
AS138-26C	1.031	26.187	0.625	15.875	0.785	19.939	0.845	21.463	0.045	1.143	4500	900	200
AS138-27A	1.050	26.670	0.500	12.700	0.810	20.574	0.870	22.098	0.045	1.143	5000	1000	200
AS138-27B	1.050	26.670	0.500	12.700	0.810	20.574	0.870	22.098	0.045	1.143	5000	1000	200
AS138-27C	1.050	26.670	0.500	12.700	0.810	20.574	0.870	22.098	0.045	1.143	5000	1000	200
AS138-28A	1.125	28.575	0.500	12.700	0.850	21.590	0.905	22.987	0.045	1.143	3500	700	200
AS138-28B	1.125	28.575	0.500	12.700	0.850	21.590	0.905	22.987	0.045	1.143	3500	700	200
AS138-28C	1.125	28.575	0.500	12.700	0.850	21.590	0.905	22.987	0.045	1.143	3500	700	200
AS138-29A	1.125	28.575	0.625	15.875	0.893	22.682	0.963	24.460	0.045	1.143	3500	700	200
AS138-29B	1.125	28.575	0.625	15.875	0.893	22.682	0.963	24.460	0.045	1.143	3500	700	200
AS138-29C	1.125	28.575	0.625	15.875	0.893	22.682	0.963	24.460	0.045	1.143	2500	500	200
AS138-30A	1.160	29.464	0.625	15.875	0.910	23.114	0.980	24.892	0.045	1.143	2500	500	100
AS138-30B	1.160	29.464	0.625	15.875	0.910	23.114	0.980	24.892	0.045	1.143	2500	500	100
AS138-30C	1.160	29.464	0.625	15.875	0.910	23.114	0.980	24.892	0.045	1.143	2500	500	200
AS138-31A	1.180	29.972	0.500	12.700	0.930	23.622	1.000	25.400	0.045	1.143	2500	500	100
AS138-31B	1.180	29.972	0.500	12.700	0.930	23.622	1.000	25.400	0.045	1.143	2500	500	100
AS138-31C	1.180	29.972	0.500	12.700	0.930	23.622	1.000	25.400	0.045	1.143	2500	500	100
AS138-33A	1.220	30.988	0.500	12.700	0.973	24.714	1.035	26.289	0.045	1.143	2500	500	100
AS138-33B	1.220	30.988	0.500	12.700	0.973	24.714	1.035	26.289	0.045	1.143	2500	500	100
AS138-33C	1.220	30.988	0.500	12.700	0.973	24.714	1.035	26.289	0.045	1.143	2500	500	200
AS138-34A	1.250	31.750	0.625	15.875	1.028	26.111	1.088	27.635	0.045	1.143	2500	500	100
AS138-34B	1.250	31.750	0.625	15.875	1.028	26.111	1.088	27.635	0.045	1.143	2500	500	100
AS138-34C	1.250	31.750	0.625	15.875	1.028	26.111	1.088	27.635	0.045	1.143	2500	500	100
AS138-35A	1.312	33.325	0.500	12.700	1.062	26.975	1.132	28.753	0.045	1.143	2500	500	100
AS138-35B	1.312	33.325	0.500	12.700	1.062	26.975	1.132	28.753	0.045	1.143	2500	500	100
AS138-35C	1.312	33.325	0.500	12.700	1.062	26.975	1.132	28.753	0.045	1.143	2500	500	100
AS138-36A	1.330	33.782	0.562	14.275	1.093	27.762	1.155	29.337	0.045	1.143	2000	400	100
AS138-36B	1.330	33.782	0.562	14.275	1.093	27.762	1.155	29.337	0.045	1.143	2000	400	100
AS138-36C	1.330	33.782	0.562	14.275	1.093	27.762	1.155	29.337	0.045	1.143	2000	400	100
AS138-37A	1.375	34.925	0.625	15.875	1.120	28.448	1.190	30.226	0.045	1.143	2500	500	100
AS138-37B	1.375	34.925	0.625	15.875	1.120	28.448	1.190	30.226	0.045	1.143	2500	500	100
AS138-37C	1.375	34.925	0.625	15.875	1.120	28.448	1.190	30.226	0.045	1.143	2500	500	100
AS138-38A	1.406	35.712	0.625	15.875	1.150	29.210	1.215	30.861	0.050	1.270	2500	500	100
AS138-38B	1.406	35.712	0.625	15.875	1.150	29.210	1.215	30.861	0.050	1.270	2500	500	100
AS138-38C	1.406	35.712	0.625	15.875	1.150	29.210	1.215	30.861	0.050	1.270	2500	500	100
AS138-39A	1.438	36.525	0.562	14.275	1.180	29.972	1.250	31.750	0.050	1.270	2500	500	100
AS138-39B	1.438	36.525	0.562	14.275	1.180	29.972	1.250	31.750	0.050	1.270	2500	500	100
AS138-39C	1.438	36.525	0.562	14.275	1.180	29.972	1.250	31.750	0.050	1.270	2500	500	100
AS138-40A	1.450	36.830	0.625	15.875	1.200	30.480	1.270	32.258	0.050	1.270	2500	500	100
AS138-40B	1.450	36.830	0.625	15.875	1.200	30.480	1.270	32.258	0.050	1.270	2500	500	100
AS138-40C	1.450	36.830	0.625	15.875	1.200	30.480	1.270	32.258	0.050	1.270	2500	500	100
AS138-41A	1.465	37.211	0.562	14.275	1.231	31.267	1.301	33.045	0.050	1.270	2500	500	100
AS138-41B	1.465	37.211	0.562	14.275	1.231	31.267	1.301	33.045	0.050	1.270	2500	500	100
AS138-41C	1.465	37.211	0.562	14.275	1.231	31.267	1.301	33.045	0.050	1.270	2500	500	100
AS138-42A	1.500	38.100	0.620	15.748	1.270	32.258	1.340	34.036	0.050	1.270	2500	500	100
AS138-42B	1.500	38.100	0.620	15.748	1.270	32.258	1.340	34.036	0.050	1.270	2500	500	100
AS138-42C	1.500	38.100	0.620	15.748	1.270	32.258	1.340	34.036	0.050	1.270	2500	500	100
AS138-43A	1.547	39.294	0.625	15.875	1.297	32.944	1.367	34.722	0.050	1.270	2500	500	100
AS138-43B	1.547	39.294	0.625	15.875	1.297	32.944	1.367	34.722	0.050	1.270	2500	500	100
AS138-43C	1.547	39.294	0.625	15.875	1.297	32.944	1.367	34.722	0.050	1.270	2500	500	100
AS138-44A	1.570	39.878	0.562	14.275	1.320	33.528	1.390	35.306	0.050	1.270	2500	500	100
AS138-44B	1.570	39.878	0.562	14.275	1.320	33.528	1.390	35.306	0.050	1.270	2500	500	100
AS138-44C	1.570	39.878	0.562	14.275	1.320	33.528	1.390	35.306	0.050	1.270	2500	500	100
AS138-45A	1.590	40.386	0.562	14.275	1.340	34.036	1.410	35.814	0.050	1.270	2500	500	100

Caplugs No.	Dimensions										Packaging		
	A		B		C		D		E		Carton Quantity	Micro Pak Quantity	Mini Pak Quantity
	In	mm	In	mm	In	mm	In	mm	In	mm			
AS138-08A	0.430	10.922	0.500	12.700	0.245	6.223	0.305	7.747	0.035	0.889	5000	1000	200
AS138-08B	0.430	10.922	0.500	12.700	0.245	6.223	0.305	7.747	0.035	0.889	5000	1000	200
AS138-08C	0.430	10.922	0.500	12.700	0.245	6.223	0.305	7.747	0.035	0.889	5000	1000	200
AS138-10A	0.500	12.700	0.500	12.700	0.305	7.747	0.365	9.271	0.035	0.889	5000	1000	200
AS138-10B	0.500	12.700	0.500	12.700	0.305	7.747	0.365	9.271	0.035	0.889	5000	1000	200
AS138-10C	0.500	12.700	0.500	12.700	0.305	7.747	0.365	9.271	0.035	0.889	5000	1000	200
AS138-11A	0.585	14.859	0.500	12.700	0.345	8.763	0.405	10.287	0.035	0.889	5000	1000	200
AS138-11B	0.585	14.859	0.500	12.700	0.345	8.763	0.405	10.287	0.035	0.889	5000	1000	200
AS138-11C	0.585	14.859	0.500	12.700	0.345	8.763	0.405	10.287	0.035	0.889	5000	1000	200
AS138-12A	0.620	15.748	0.500	12.700	0.368	9.347	0.438	11.125	0.035	0.889	5000	1000	200
AS138-12B	0.620	15.748	0.500	12.700	0.368	9.347	0.438	11.125	0.035	0.889	5000	1000	200
AS138-12C	0.620	15.748	0.500	12.700	0.368	9.347	0.438	11.125	0.035	0.889	5000	1000	200
AS138-14A	0.670	17.018	0.625	15.875	0.413	10.490	0.483	12.268	0.040	1.016	5000	1000	200
AS138-14B	0.670	17.018	0.625	15.875	0.413	10.490	0.483	12.268	0.040	1.016	5000	1000	200
AS138-14C	0.670	17.018	0.625	15.875	0.413	10.490	0.483	12.268	0.040	1.016	5000	1000	200
AS138-15A	0.682	17.323	0.625	15.875	0.442	11.227	0.502	12.751	0.040	1.016	5000	1000	200
AS138-15B	0.682	17.323	0.625	15.875	0.442	11.227	0.502	12.751	0.040	1.016	5000	1000	

AS138 Series Electrical Connector Dust Caps (cont.)

Electrical Connector Dust Caps (cont.) AS138 Series

Caplugs No.	Dimensions										Packaging		
	A		B		C		D		E		Carton Quantity	Micro Pak Quantity	Mini Pak Quantity
	In	mm	In	mm	In	mm	In	mm	In	mm			
AS138-45B	1.590	40.386	0.562	14.275	1.340	34.036	1.410	35.814	0.050	1.270	2500	500	100
AS138-45C	1.590	40.386	0.562	14.275	1.340	34.036	1.410	35.814	0.050	1.270	2500	500	100
AS138-46A	1.610	40.894	0.625	15.875	1.360	34.544	1.430	36.322	0.050	1.270	1000	200	100
AS138-46B	1.610	40.894	0.625	15.875	1.360	34.544	1.430	36.322	0.050	1.270	1000	200	100
AS138-46C	1.610	40.894	0.625	15.875	1.360	34.544	1.430	36.322	0.050	1.270	1000	200	100
AS138-47A	1.640	41.656	0.620	15.748	1.390	35.306	1.460	37.084	0.050	1.270	1000	200	100
AS138-47B	1.640	41.656	0.620	15.748	1.390	35.306	1.460	37.084	0.050	1.270	1000	200	100
AS138-47C	1.640	41.656	0.620	15.748	1.390	35.306	1.460	37.084	0.050	1.270	1000	200	100
AS138-48A	1.670	42.418	0.560	14.224	1.416	35.966	1.486	37.744	0.050	1.270	1000	200	100
AS138-48B	1.670	42.418	0.560	14.224	1.416	35.966	1.486	37.744	0.050	1.270	1000	200	100
AS138-48C	1.670	42.418	0.560	14.224	1.416	35.966	1.486	37.744	0.050	1.270	1000	200	100
AS138-50A	1.700	43.180	0.562	14.275	1.463	37.160	1.533	38.938	0.050	1.270	1500	300	100
AS138-50B	1.700	43.180	0.562	14.275	1.463	37.160	1.533	38.938	0.050	1.270	1500	300	100
AS138-50C	1.700	43.180	0.562	14.275	1.463	37.160	1.533	38.938	0.050	1.270	1500	300	100
AS138-49A	1.700	43.180	0.625	15.875	1.450	36.830	1.520	38.608	0.050	1.270	1000	200	100
AS138-49B	1.700	43.180	0.625	15.875	1.450	36.830	1.520	38.608	0.050	1.270	1000	200	100
AS138-49C	1.700	43.180	0.625	15.875	1.450	36.830	1.520	38.608	0.050	1.270	1000	200	100
AS138-51A	1.810	45.974	0.620	15.748	1.540	39.116	1.610	40.894	0.050	1.270	1000	200	100
AS138-51B	1.810	45.974	0.620	15.748	1.540	39.116	1.610	40.894	0.050	1.270	1000	200	100
AS138-51C	1.810	45.974	0.620	15.748	1.540	39.116	1.610	40.894	0.050	1.270	1000	200	100
AS138-52A	1.820	46.228	0.562	14.275	1.570	39.878	1.640	41.656	0.050	1.270	1000	200	100
AS138-52B	1.820	46.228	0.562	14.275	1.570	39.878	1.640	41.656	0.050	1.270	1000	200	100
AS138-52C	1.820	46.228	0.562	14.275	1.570	39.878	1.640	41.656	0.050	1.270	1000	200	100
AS138-53A	1.850	46.990	0.562	14.275	1.600	40.640	1.670	42.418	0.055	1.397	1000	200	100
AS138-53B	1.850	46.990	0.562	14.275	1.600	40.640	1.670	42.418	0.055	1.397	1000	200	100
AS138-53C	1.850	46.990	0.562	14.275	1.600	40.640	1.670	42.418	0.055	1.397	1000	200	100
AS138-55A	1.880	47.752	0.620	15.748	1.648	41.859	1.718	43.637	0.055	1.397	1000	200	100
AS138-55B	1.880	47.752	0.620	15.748	1.648	41.859	1.718	43.637	0.055	1.397	1000	200	100
AS138-55C	1.880	47.752	0.620	15.748	1.648	41.859	1.718	43.637	0.055	1.397	1000	200	100
AS138-57A	1.950	49.530	0.562	14.275	1.715	43.561	1.790	45.466	0.055	1.397	1000	200	100
AS138-57B	1.950	49.530	0.562	14.275	1.715	43.561	1.790	45.466	0.055	1.397	1000	200	100
AS138-57C	1.950	49.530	0.562	14.275	1.715	43.561	1.790	45.466	0.055	1.397	1000	200	100
AS138-60A	2.020	51.308	0.562	14.275	1.770	44.958	1.840	46.736	0.055	1.397	1000	200	100

Caplugs No.	Dimensions										Packaging		
	A		B		C		D		E		Carton Quantity	Micro Pak Quantity	Mini Pak Quantity
	In	mm	In	mm	In	mm	In	mm	In	mm			
AS138-60B	2.020	51.308	0.562	14.275	1.770	44.958	1.840	46.736	0.055	1.397	1000	200	100
AS138-60C	2.020	51.308	0.562	14.275	1.770	44.958	1.840	46.736	0.055	1.397	1000	200	100
AS138-63A	2.120	53.848	0.620	15.748	1.890	48.006	1.970	50.038	0.055	1.397	1000	200	100
AS138-63B	2.120	53.848	0.620	15.748	1.890	48.006	1.970	50.038	0.055	1.397	1000	200	100
AS138-63C	2.120	53.848	0.620	15.748	1.890	48.006	1.970	50.038	0.055	1.397	N/A	1000	N/A
AS138-65A	2.220	56.388	0.560	14.224	1.965	49.911	2.040	51.816	0.055	1.397	1000	200	100
AS138-65B	2.220	56.388	0.560	14.224	1.965	49.911	2.040	51.816	0.055	1.397	1000	200	100
AS138-65C	2.220	56.388	0.560	14.224	1.965	49.911	2.040	51.816	0.055	1.397	1000	200	100
AS138-71A	2.340	59.436	0.620	15.748	2.140	54.356	2.210	56.134	0.055	1.397	1000	200	100
AS138-71B	2.340	59.436	0.620	15.748	2.140	54.356	2.210	56.134	0.055	1.397	1000	200	100
AS138-71C	2.340	59.436	0.620	15.748	2.140	54.356	2.210	56.134	0.055	1.397	1000	200	100
AS138-74A	2.435	61.849	0.600	15.240	2.215	56.261	2.290	58.166	0.055	1.397	1000	200	100
AS138-74B	2.435	61.849	0.600	15.240	2.215	56.261	2.290	58.166	0.055	1.397	1000	200	100
AS138-74C	2.435	61.849	0.600	15.240	2.215	56.261	2.290	58.166	0.055	1.397	1000	200	100
AS138-75A	2.500	63.500	0.600	15.240	2.280	57.912	2.355	59.817	0.055	1.397	1000	200	100
AS138-75B	2.500	63.500	0.600	15.240	2.280	57.912	2.355	59.817	0.055	1.397	1000	200	100
AS138-75C	2.500	63.500	0.600	15.240	2.280	57.912	2.355	59.817	0.055	1.397	1000	200	100
AS138-77A	2.600	66.040	0.620	15.748	2.380	60.452	2.450	62.230	0.060	1.524	700	140	100
AS138-77B	2.600	66.040	0.620	15.748	2.380	60.452	2.450	62.230	0.060	1.524	700	140	100
AS138-77C	2.600	66.040	0.620	15.748	2.380	60.452	2.450	62.230	0.060	1.524	700	140	100
AS138-81A	2.660	67.564	0.600	15.240	2.440	61.976	2.530	64.262	0.060	1.524	N/A	500	N/A
AS138-81B	2.660	67.564	0.600	15.240	2.440	61.976	2.530	64.262	0.060	1.524	500	100	50
AS138-81C	2.660	67.564	0.600	15.240	2.440	61.976	2.530	64.262	0.060	1.524	N/A	500	N/A
AS138-87A	2.880	73.152	0.620	15.748	2.630	66.802	2.700	68.580	0.060	1.524	500	100	50
AS138-87B	2.880	73.152	0.620	15.748	2.630	66.802	2.700	68.580	0.060	1.524	500	100	50
AS138-87C	2.880	73.152	0.620	15.748	2.630	66.802	2.700	68.580	0.060	1.524	500	100	50
AS138-90A	2.960	75.184	0.600	15.240	2.720	69.088	2.812	71.425	0.060	1.524	500	100	50
AS138-90B	2.960	75.184	0.600	15.240	2.720	69.088	2.812	71.425	0.060	1.524	500	100	50
AS138-90C	2.960	75.184	0.600	15.240	2.720	69.088	2.812	71.425	0.060	1.524	500	100	50
AS138-96A	3.120	79.248	0.620	15.748	2.880	73.152	2.950	74.930	0.060	1.524	500	100	50
AS138-96B	3.120	79.248	0.620	15.748	2.880	73.152	2.950	74.930	0.060	1.524	500	100	50
AS138-96C	3.120	79.248	0.620	15.748	2.880	73.152	2.950	74.930	0.060	1.524	500	100	50
AS138-98A	3.220	81.788	0.600	15.240	2.960	75.184	3.050	77.470	0.060	1.524	500	100	50
AS138-98B	3.220	81.788	0.600	15.240	2.960	75.184	3.050	77.470	0.060	1.524	500	100	50
AS138-98C	3.220	81.788	0.600	15.240	2.960	75.184	3.050	77.470	0.060	1.524	500	100	50

X-ON Electronics

Largest Supplier of Electrical and Electronic Components

Click to view similar products for [Standard Circular Connector](#) category:

Click to view products by [Caplugs](#) manufacturer:

Other Similar products are found below :

[5M2530B10P](#) [600259N006](#) [600273N007](#) [6134-336-13149](#) [6134-337-11149](#) [6134-337-2390](#) [6134-341-17149](#) [6280-4SG-516](#) [6280-7SG-3DC](#)
[6290](#) [6291A](#) [66200A-10](#) [680-SMG](#) [681-PMG](#) [CXS3102A14S2P](#) [CXS3102A181S](#) [7251-5SG-300](#) [7271-6SG-300](#) [7282-3PG-300-CH3](#) [75-](#)
[474618-01S](#) [75-474618-04P](#) [75-474618-04S](#) [799539-000](#) [MI8-SE](#) [805-005-07NF11-19PC](#) [805-005-07NF15-7PA](#) [8280-4PG-516](#) [8280-7PG-](#)
[519](#) [8282-5PG-519](#) [836783-1](#) [MP-4102-25P-C](#) [862256-1](#) [864019-2](#) [866857-1](#) [867865-1](#) [PT01SP-14-18P](#) [PT08P-14-5S](#) [PTSF06SE-14-12S](#)
[120-1833-000](#) [QCM019PC2DC012B](#) [1-2069279-1](#) [121583-0217](#) [121667-0020](#) [129591AU](#) [1000B BULK](#) [RD10A16-19-P6CS051/1](#)
[RD10A20-31-P8CS051/1](#) [RD16A14-12-S6CS051/2](#) [1301240290](#) [1301240347](#) [1301860202](#)