



<http://www.capxongroup.com>

CapXon

Professional

ELECTROLYTIC CAPACITORS

2018/2019

CapXon
Catalog 2018/2019
Aluminum Electrolytic Capacitors



AEC-Q200
IATF 16949

CapXon

英屬維京群島商凱普松科技股份有限公司
台灣分公司
Capxon Technology Limited Taiwan Branch
新北市汐止區大同路二段157號5樓
5F, No. 157, Da Tung Road, Sec. 2, XiZhi Dist.,
New Taipei City, 22183, Taiwan R. O. C.
TEL : +886-2-8692-6611 FAX : +886-2-8692-6477 / 8692-6481
E-mail: sales@capxon.com.tw

英屬維京群島商凱普松科技股份有限公司
台灣分公司－歐洲辦事處
Capxon Europe Office
Schwalbenweg 11, 72793 Pfullingen, Germany
TEL : +49-151-11355795
E-mail: sales@capxon-europe.com

豐賓電子（深圳）有限公司
Capxon Electronic (Shen-Zhen) Co., Ltd.
518106 廣東省深圳市光明新區公明街道塘尾社區松白路4132號(塘尾工業區)
No.4132, Songbai Road, Tangwei Village, Gongming Sub-district, Guangming
New District, Shenzhen City, Guangdong, China
Post Code : 518106
TEL : +86-755-2717-7888 FAX : +86-755-2717-7802
E-mail: sales@capxon.com.cn

豐賓電子（深圳）有限公司－蘇州辦事處
Capxon Electronic (Shen-Zhen) Co., Ltd. – Su-Zhou Office
江蘇省蘇州市高新區錦峰路158號3樓
Room 301-2, Building 22, NO.158 Jinfeng Road, High-tech Zone, Suzhou, China
TEL : +86-0512-68780980 FAX : +86-512-68780981
E-mail: sales@capxon.com.cn

* 本商品目錄所記載的內容，可能會在沒有預先通知的情況下發生更改，敬請諒解。
* Specifications subject to change without notice

Aluminum Electrolytic Capacitors Conductive Polymer Capacitors Conductive Hybrid Capacitors

**ALUMINUM
ELECTROLYTIC
CAPACITORS**

CONTENTS	PAGE
1. List of the Products	002
2. Product System	005
3. Part Number System	008
4. Lead Treatment	010
5. Package for SMD Type	016
6. Available terminal for Snap-in Type	017
7. Package for Snap-in Type	020
8. Series Discontinued	020
9. General technical information	021
10. Quality and environment	034
11. Precautions & Guidelines	037
12. Individual Specification by Series	044
13. Disclaimer	406
14. Memo	407

Note:1.Specification and dimensions in this catalogue are subject to change without notice. If necessary, drawing can be provided.
2.Catalogue printed in May 2018

	Series Sleeve Color	Page	Type	Features	Operating Temperature Range	Working Voltage	Capacitance	Endurance Hours
Conductive Polymer	PL	044	Radial	Very low ESR	-55 to +105 °C	2.5~16V	180~3500μF	2000
	PS	047	Radial	Standard	-55 to +105 °C	2.5~25V	39~3500μF	2000
	PU	051	Radial	Ultra low ESR	-55 to +105 °C	2.5~10V	180~3900μF	2000
	PX	054	Radial	Low profile	-55 to +105 °C	2.5~25V	6.8~820μF	2000
	PE	057	Radial	Ultra low ESR, Down size to 6.3X8 (mm)	-55 to +105 °C	2.5~16V	270~1200μF	2000
	PW	058	Radial	Low height 2000Hours	-55 to +105 °C	2.5V~25V	39~2500μF	2000
	PH	061	Radial	High Voltage/High Reliability	-55 to +105 °C	35V~100V	6.8~330μF	2000
	PT	064	Radial	125 °C Guaranteed	-55 to +125 °C	2.5~50V	22~2700μF	2000
	PF	067	Radial	Long Life to 5,000Hours	-55 to +105 °C	2.5~35V	10~2700μF	5000
	PM	070	SMD	SMD & Low profile	-55 to +105 °C	2.5~100V	4.7~560μF	2000
	PD	074	SMD	SMD & Large capacitance	-55 to +105 °C	2.5~100V	10~3300μF	2000
	PV	077	SMD	SMD & Low height	-55 to +105 °C	2.5~100V	6.8~2500μF	2000
	PR	080	SMD	SMD & Long Life to 5,000Hours	-55 to +105 °C	6.3~50V	10~1500μF	5000
	PG	083	SMD	SMD & 125 °C Guaranteed	-55 to +125 °C	6.3~50V	10~1500μF	2000
Hybrid Conductive Polymer	AS <small>NEW</small>	086	Radial	Low ESR, High Voltage, Long Life	-55 to +105 °C	16~100V	10~560μF	3000~10000
	AT <small>NEW</small>	088	Radial	125°C, High Reliability, High Ripple Curren	-55 to +125 °C	16~40V	27~560μF	3000
	AA <small>NEW</small>	090	SMD	Low ESR, High Voltage, High Reliability, Long Life	-55 to +105 °C	25~80V	22~330μF	10000
	AC <small>NEW</small>	092	SMD	125°C, Low ESR, High Voltage, High Reliability, Long Life	-55 to +125 °C	25~80V	22~330μF	4000
SMD type	EV	094	SMD	105 °C, Standard	-55 to +105 °C	6.3~50V	0.1~1500μF	1000
	LV	096	SMD	85 °C, Standard	-40 to +85 °C	4~450V	0.1~6800μF	2000
	HV	099	SMD	Wide temperature range	-55 to +105 °C -40 to +105 °C	6.3~100V 160~450V	0.1~6800μF 2.2~68μF	2000
	JV	102	SMD	3000 hours life	-55 to +105 °C	6.3~50V	0.1~1000μF	3000
	MV	104	SMD	5000 hours life	-40 to +105 °C	6.3~50V	0.1~1000μF	5000
	CV	106	SMD	7000 hours life	-25 to +105 °C	6.3~50V	22~1500μF	7000
	NV	108	SMD	5.5 ~ 10.5mm height, Non-polar	-40 to +85 °C	6.3~50V	0.1~560μF	2000
	KV	110	SMD	85 °C, Low leakage current	-40 to +85 °C	6.3~50V	0.1~330μF	1000
	ZV	112	SMD	105 °C, Low impedance	-55 to +105 °C	6.3~50V	2.2~6800μF	2000~5000
	DV	115	SMD	105 °C, Low impedance	-55 to +105 °C	6.3~100V	1~6800μF	2000~5000
	RV	118	SMD	105 °C, Low impedance, LongLife	-55 to +105 °C -40 to +105 °C	6.3~100V 160~450V	1~6800μF 2.2~68μF	2000~5000
	TV	121	SMD	For high temperature + 125 °C	-40 to +125 °C	10~450V	1~330μF	1000~2000
Ultra-miniature type	SS	123	Radial	5mm, Standard, 85 °C	-40 to +85 °C	4~50V	0.1~330μF	1000
	ST	125	Radial	5mm, Standard, 105 °C	-40 to +105 °C	4~50V	0.1~220μF	1000
	SA	127	Radial	5mm, Low leakage current	-40 to +85 °C	4~50V	0.1~100μF	1000
	SP	129	Radial	5mm, Non-polar	-40 to +85 °C	6.3~50V	0.1~47μF	1000
	SM	131	Radial	7mm, Standard, 85 °C	-40 to +85 °C	4~63V	0.1~470μF	1000
	SH	133	Radial	7mm, 85 °C, Long life	-40 to +85 °C	4~63V	0.1~470μF	2000
	SK	135	Radial	7mm, Standard, 105 °C	-40 to +105 °C	4~63V	0.1~470μF	1000
	SJ	137	Radial	7mm, 105 °C, Long life 2000 hours	-40 to +105 °C	6.3~63V	0.1~220μF	2000
	SG	139	Radial	7mm, 105 °C, Long life 4000 hours	-40 to +105 °C	6.3~50V	0.1~470μF	4000
	SL	141	Radial	7mm, Low leakage current, 85 °C	-40 to +85 °C	6.3~50V	0.1~220μF	1000
	SD	143	Radial	7mm, Low leakage current, 105 °C	-40 to +105 °C	4~63V	0.1~100μF	1000
	SN	145	Radial	7~ 9mm, Non-polar, 85 °C	-40 to +85 °C	6.3~50V	0.1~220μF	1000

	Series Sleeve Color	Page	Type	Features	Operating Temperature Range	Working Voltage	Capacitance	Endurance Hours
Ultra-miniature type	SB	147	Radial	7mm, Non-polar, 105 °C	-40 to +105 °C	6.3~50V	0.1~100μF	1000
	SZ	149	Radial	7mm, Low impedance	-55 to +105 °C	6.3~35V	6.8~330μF	1000
	SY	151	Radial	7mm, Low impedance, Long life	-55 to +105 °C	6.3~50V	1~330μF	2000
Standard type	GS	153	Radial	General purpose, 85 °C	-40 to +85 °C -25 to +85 °C	6.3~100V 160~450V	0.1~33000μF 0.47~560μF	2000
	GW	158	Radial	9~25mm height low profile, 85 °C	-40 to +85 °C -25 to +85 °C	6.3~100V 160~450V	2.2~10000μF 2.2~220μF	2000
	KM	161	Radial	Standard, 105 °C	-40 to +105 °C -25 to +105 °C	6.3~100V 160~500V	0.1~22000μF 0.47~560μF	2000
	KW	167	Radial	9~25mm height low profile, 105 °C	-40 to +105 °C -25 to +105 °C	6.3~100V 160~450V	2.2~10000μF 1.5~150μF	2000
	KC	170	Radial	Ultra Miniaturized	-25 to +105 °C	400~450V	82~220μF	3000
	LL	172	Radial	Low leakage current	-40 to +105 °C	6.3~63V	0.1~2200μF	2000
Low Impedance / ESR type	GL	174	Radial	Low impedance and Low ESR Miniaturized	-55 to +105 °C	6.3~63V	0.47~10000μF	2000~6000
	KF	177	Radial	Low impedance for power supply	-40 to +105 °C -25 to +105 °C	6.3~100V 160~450V	0.47~15000μF 0.47~330μF	2000~5000
	KZ	182	Radial	Low impedance	-40 to +105 °C	6.3~50V	0.47~6800μF	1000~2000
	GF	185	Radial	Low impedance	-55 to +105 °C	6.3V~100V	4.7~6800μF	2000~5000
	LZ	188	Radial	Ultra low ESR and High ripple current	-40 to +105 °C	6.3~25V	220~3300μF	2000
	GH	190	Radial	High temperature and Long life	-55 to +105 °C	6.3~100V	0.47~12000μF	5000~10000
	GT	196	Radial	Miniaturized and Long life	-40 to +105 °C	10~100V	1~330μF	10000
For lighting	FB	*	Radial	105°C standard	-40 to +105 °C	6.3~120V	0.47~22000uF	2000
	FC	*	Radial	high ripple current and Low ESR	-40 to +105 °C	6.3~120V	0.47~22000uF	3000~6000
	FD	*	Radial	High Reliability	-40 to +105 °C	6.3~120V	0.47~22000uF	4000~8000
	FE	*	Radial	high ripple current, Low ESR and long life	-40 to +105 °C	6.3~120V	0.47~22000uF	5000~10000
	FF	*	Radial	Miniaturized and Long life	-40 to +105 °C	6.3~120V	0.47~22000uF	6000~12000
	FG	*	Radial	For hing temperature +130°C , Long life	-40 to +130°C	6.3~100V	0.47~22000uF	2000~5000
	FR	*	Radial	105°C standard	-40 to +105 °C	160~550V	0.47~560uF	2000
	FS	*	Radial	Miniaturized , high cost performance	-40 to +105 °C	160~500V	0.47~560uF	3000
	FT	*	Radial	Miniaturized and Long life , Economical	-40 to +105 °C	160~500V	0.47~560uF	6000
	FU	*	Radial	Miniaturized and Long life	-40 to +105 °C	160~500V	0.47~560uF	10000
	FW	*	Radial	Miniaturized and Utlar Long life	-40 to +105 °C	160~450V	1~560uF	12000~20000
	FX	*	Radial	For hing temperature +130°C , Miniaturized and Long life	-40 to +130°C	160~450V	1~560uF	2000~5000
High reliability type	FH	198	Radial	Low ESR and Long Life	-40 to +105 °C	6.3V~100V	6.8~18000μF	4000~10000
	ZH	202	Radial	Ultra low ESR and Long Life	-40 to +105 °C	6.3V~100V	8.2~8200μF	6000~10000
	KL	205	Radial	Long life 5,000 hours	-40 to +105 °C -25 to +105 °C	160~400V 450~500V	3.3~330μF 2.2~180μF	5000
	KH	208	Radial	Long life 5,000~10,000 hours	-40 to +105 °C -25 to +105 °C	10~400V 450V	6.8~3300μF 6.8~100μF	5000~10000
	TH	211	Radial	For high temperature +125 °C	-40 to +125 °C -25 to +125 °C	10~400V 450V	0.47~8200μF 1~47μF	1000~3000
	TE	215	Radial	For high temperature +130 °C	-40 to +130 °C -25 to +130 °C	10~400V 450V	2.2~4700μF 1~100μF	1000~3000
	KS	218	Radial	Over voltage vent operating facility	-25 to +105 °C	200,400W	4.7~470μF	2000
	FK	220	Radial	Long life for LED and ballast	-40 to +105 °C -25 to +105 °C	160~450V 500V	1~330μF 4.7~120μF	6000~8000
	FL	223	Radial	Long life for LED and ballast	-40 to +105 °C -25 to +105 °C	160~450V 500V	1~680μF 10~68μF	8000~12000
	LE	227	Radial	Long life for LED lighting	-40 to +105 °C	160~450W	1~68μF	12000~20000
	KY	229	Radial	Slim type	-25 to +105 °C	250~450W	12~150μF	2000
	LY	231	Radial	Slim type, longlife 5000hours	-25 to +105 °C	250~450W	12~150μF	5000
	HY	233	Radial	Slim type, longlife 10000hours	-25 to +105 °C	250~450W	12~120μF	10000

	Series Sleeve Color	Page	Type	Features	Operating Temperature Range	Working Voltage	Capacitance	Endurance Hours
Non-polarized type	NP	235	Radial	Non-polarized,85°C	-40 to +85 °C -25 to +85 °C	6.3~100V 160~250V	0.47~3300μF 0.47~47μF	2000
	NK	237	Radial	Non-polarized,105°C	-40 to +105 °C -25 to +105°C	6.3~100V 160~250V	0.47~3300μF 0.47~47μF	2000
For Audio Equipment	SW	239	Radial	5mm height,for audio equipment	-40 to +85°C	4~50V	0.1~470μF	1000
	SR	241	Radial	7mm height,for audio equipment	-40 to +85°C	6.3~50V	0.1~220μF	1000
	RW	243	Radial	standard,for audio equipment	-40 to +85°C	6.3~100V	0.1~33000μF	2000
	NR	245	Radial	Non-polar,for audio equipment	-40 to +85°C	6.3~100V	0.15~1000μF	2000
Photo flash type	SF	247	Snap-in	Photo flash equipment	-20 to +55°C	330/350V	150~1500μF	5000 times
	RF	248	Radial	Photo flash equipment	-20 to +55°C	330/350V	100~450μF	5000 times
Large can type	LR	249	Snap-in	85°C , for audio equipment	-40 to +85°C	16~100V	680~33000μF	2000
	LP	254	Snap-in	85 °C, Standard	-40 to +85 °C -25 to +85 °C	6.3~450V 500~600V	22~100000μF 47~1500μF	2000
	LU	263	Snap-in	85 °C, Longlife 3000hours	-40 to +85 °C -25 to +85 °C	10~450V 500~600V	47~82000μF 47~1500μF	3000
	LD <small>NEW</small>	272	Snap-in	85 °C, Longlife 5000hours	-40 to +85 °C -25 to +85 °C	10~450V 500V	47~100000μF 47~1500μF	5000
	HP	280	Snap-in	105 °C, Standard	-40 to +105 °C -25 to +105 °C	6.3~450V 500~550V	56~100000μF 47~1000μF	2000
	HW	290	Snap-in	105 °C, Low Profile 15mm height	-40 to +105 °C	160~400V	39~390μF	2000
	HU	293	Snap-in	105 °C, Longlife 3000hours	-40 to +105 °C -25 to +105 °C	10~450V 500V	33~82000μF 39~470μF	3000
	HL	302	Snap-in	Long life with low ESR	-40 to +105 °C -25 to +105 °C	10~450V 500V	39~56000μF 47~470μF	5000
	LT	310	Snap-in	4 Snap-in terminals type	-40 to +85 °C -25 to +85 °C	16~450V 500V	330~82000μF 220~1500μF	2000
	HT	314	Snap-in	4 Snap-in terminals type	-40 to +105°C	160~450V	82~2700μF	2000
For inverter	UB	318	Snap-in	Useful life 5000hours	-40 to +105 °C -25 to +105 °C	200~450V 500V	68~3300μF 100~1500μF	2000
	UC	323	Snap-in	Useful life 7000hours	-40 to +105 °C -25 to +105 °C	200~450V 500~630V	68~6800μF 56~1500μF	3000
	UD	329	Snap-in	Useful life 10000hours	-40 to +105 °C -25 to +105 °C	200~450V 500~600V	68~2700μF 47~680μF	5000
	UJ	334	Snap-in	Useful life 5000hours	-40 to +105 °C -25 to +105 °C	200~450V 500~550V	82~3300μF 47~1000μF	2000
	UK	339	Snap-in	Useful life 8000hours	-40 to +105 °C -25 to +105 °C	200~450V 500~550V	68~2200μF 47~680μF	3000
	UL	344	Snap-in	Useful life 10000hours	-40 to +105 °C -25 to +105 °C	200~450V 500~550V	82~2700μF 47~680μF	5000
Screw large can type	RS	350	Screw	General,useful life 12000hours	-40 to +85 °C	10~100V	1800~1000000μF	2000
	RG	355	Screw	Useful life 6000hours	-40 to +85 °C -25 to +85 °C	160~450V 500~630V	390~39000μF 1000~10000μF	2000
	RP	359	Screw	Useful life 10000hours	-40 to +85 °C -25 to +85 °C	160~450V 500~630V	270~68000μF 100~10000μF	2000
	RX	365	Screw	useful life 20000hours	-40 to +85 °C -25 to +85 °C	160~450V 500~650V	220~100000μF 10000~15000μF	5000
	RU	371	Screw	useful life 12000hours high ripple current	-40 to +85 °C -25 to +85 °C	160~450V 500V	1000~33000μF 820~10000μF	2000
	RJ	375	Screw	useful life 10000hours with stud	-40 to +85 °C	350~450V	1500~22000μF	2000
	RY	378	Screw	useful life 12000hours high ripple current with stud	-40 to +85 °C	350~450V	1500~22000μF	2000
	RK	381	Screw	General	-40 to +105 °C	10~100V	1000~1000000μF	2000
	RL	386	Screw	Long life	-40 to +105 °C -25 to +105 °C	160~450V 500V	220~22000μF 680~8200μF	5000
	RM	391	Screw	useful life 6000hours	-40 to +105 °C -25 to +105 °C	160~450V 500V	180~68000μF 330~10000μF	2000
	RH	396	Screw	useful life 8000hours high ripple current	-40 to +105 °C	160~450V	220~47000μF	2000
	RQ	400	Screw	useful life 6000hours with stud	-40 to +105 °C	160~450V	2200~47000μF	2000
RT	403	Screw	useful life 8000hours high ripple current with stud	-40 to +105 °C	160~450V	2200~47000μF	2000	

※About the Aluminum Electrolytic Capacitor related to Automotive Electronics applications, please contact us.

Radial type of Aluminum Electrolytic Capacitors

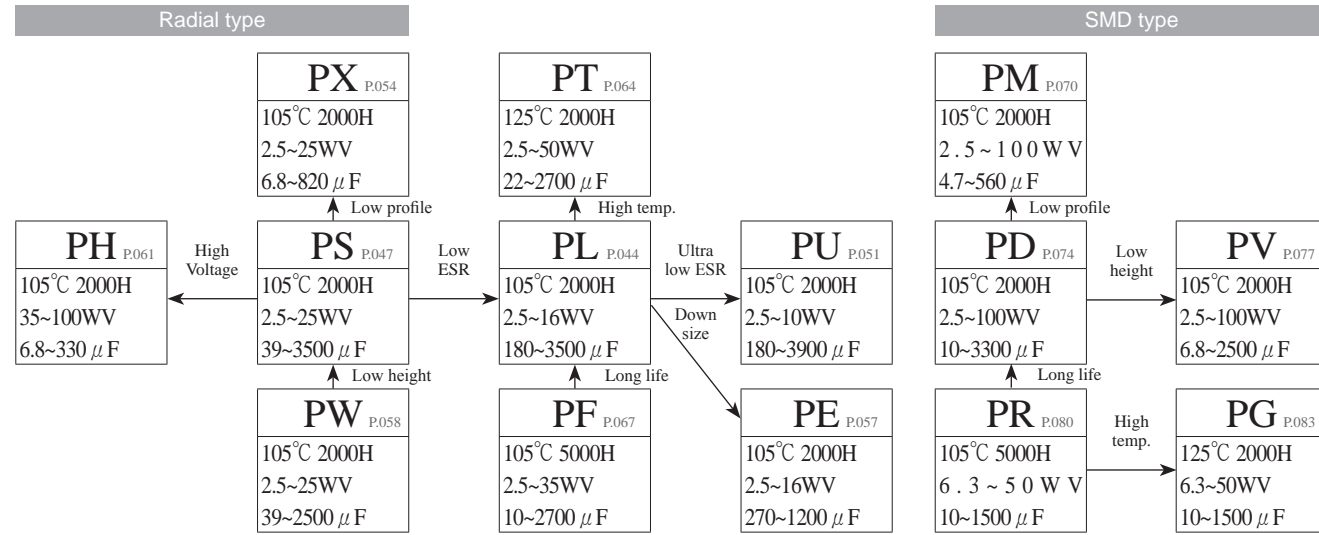

Hybrid Conductive Polymer Aluminum Electrolytic Capacitors



SMD type of Aluminum Electrolytic Capacitors

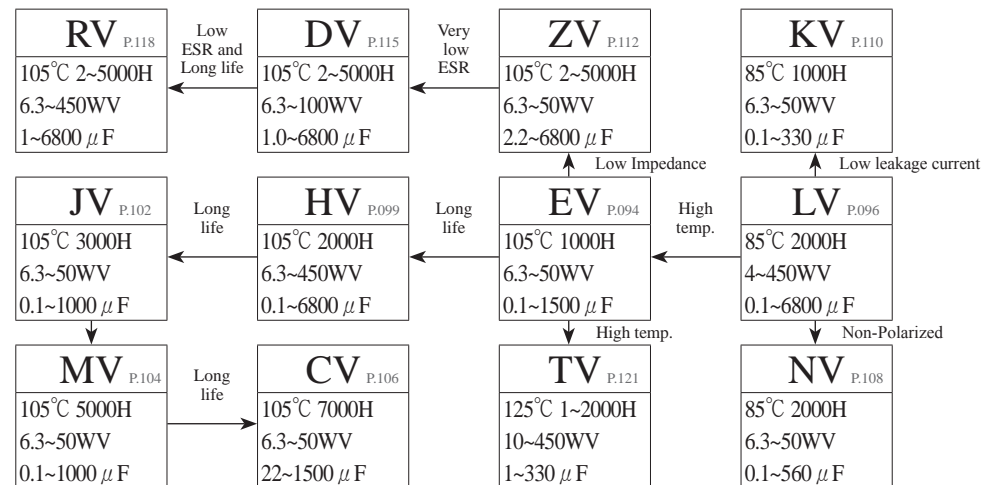

Radial type of Aluminum Electrolytic Capacitors

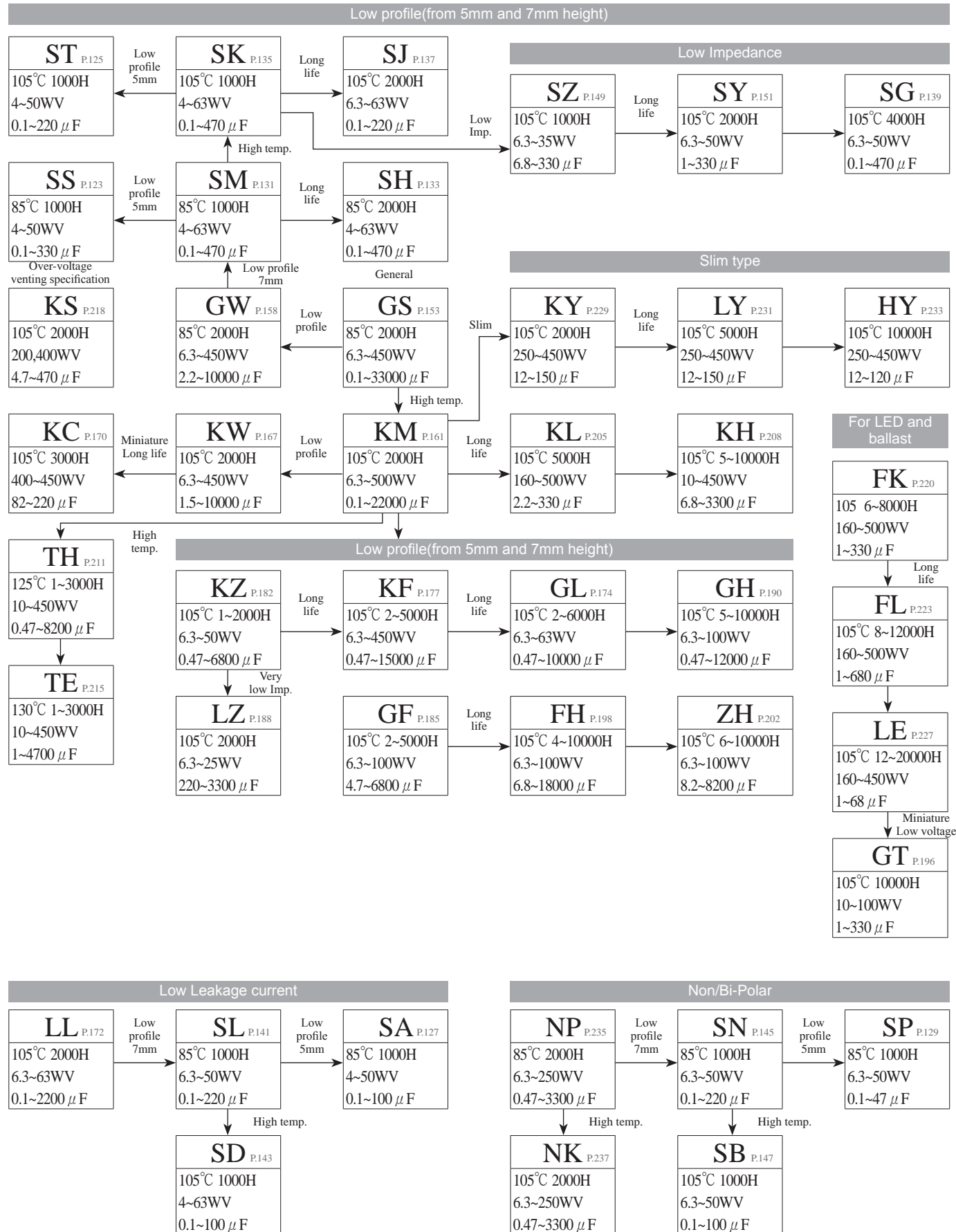

Aluminum Electrolytic Capacitors for audio equipment

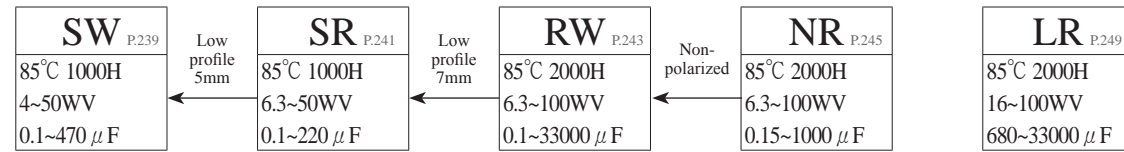

Snap-in type of Aluminum Electrolytic Capacitors

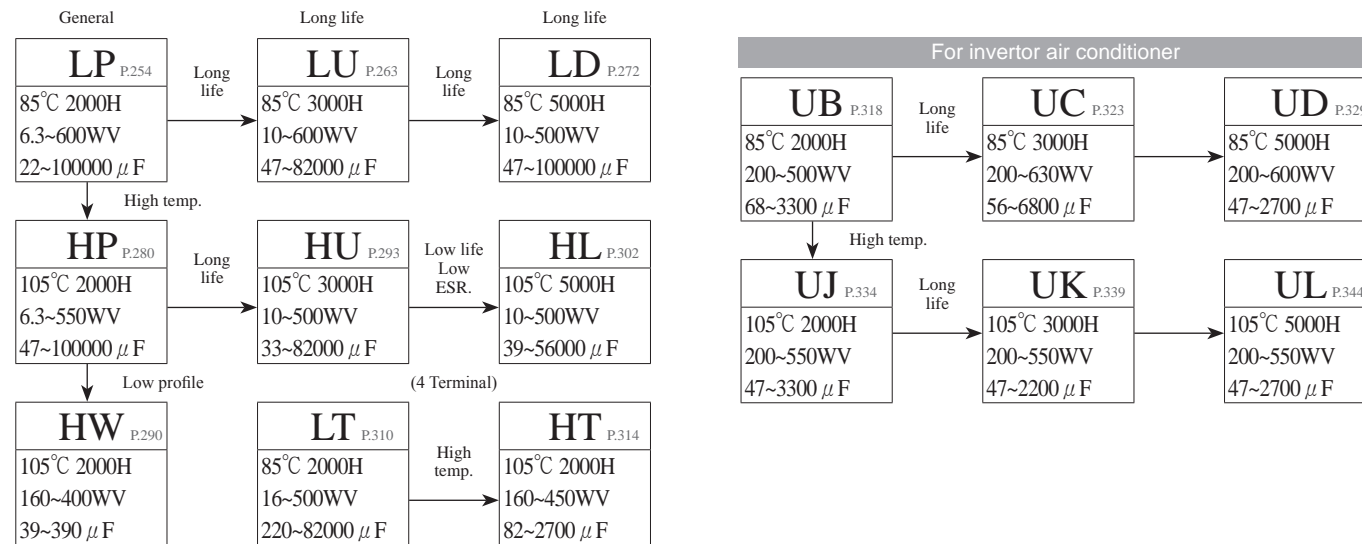
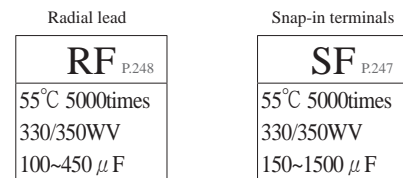
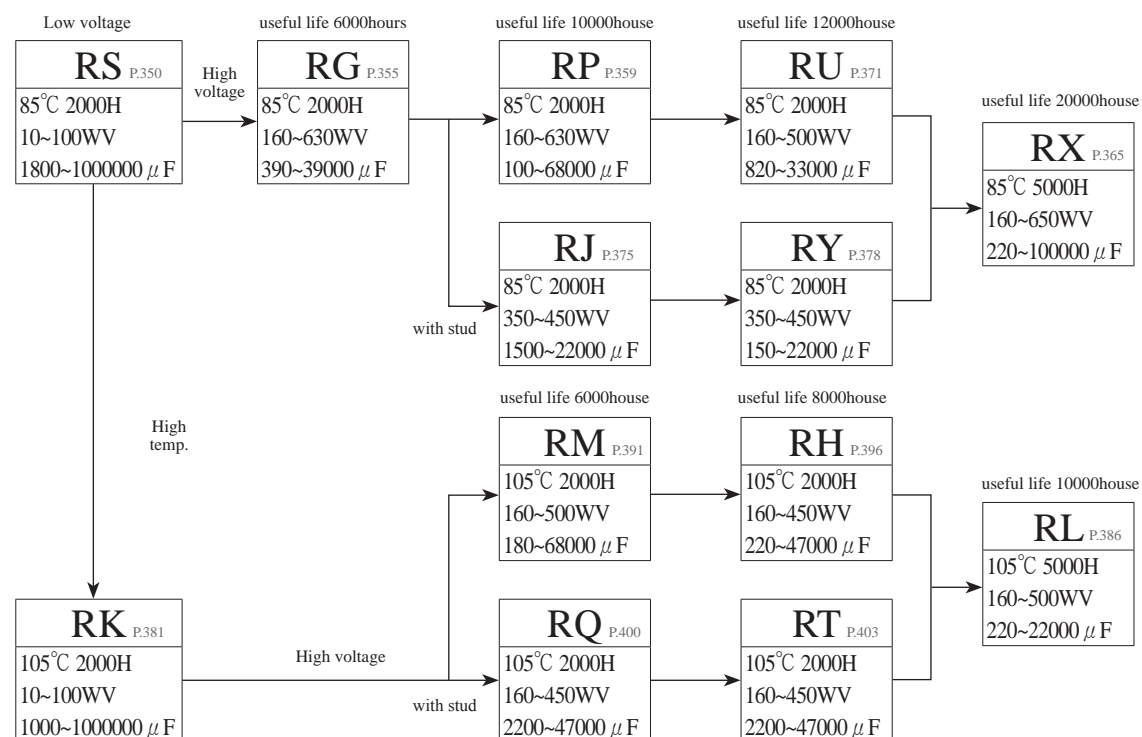
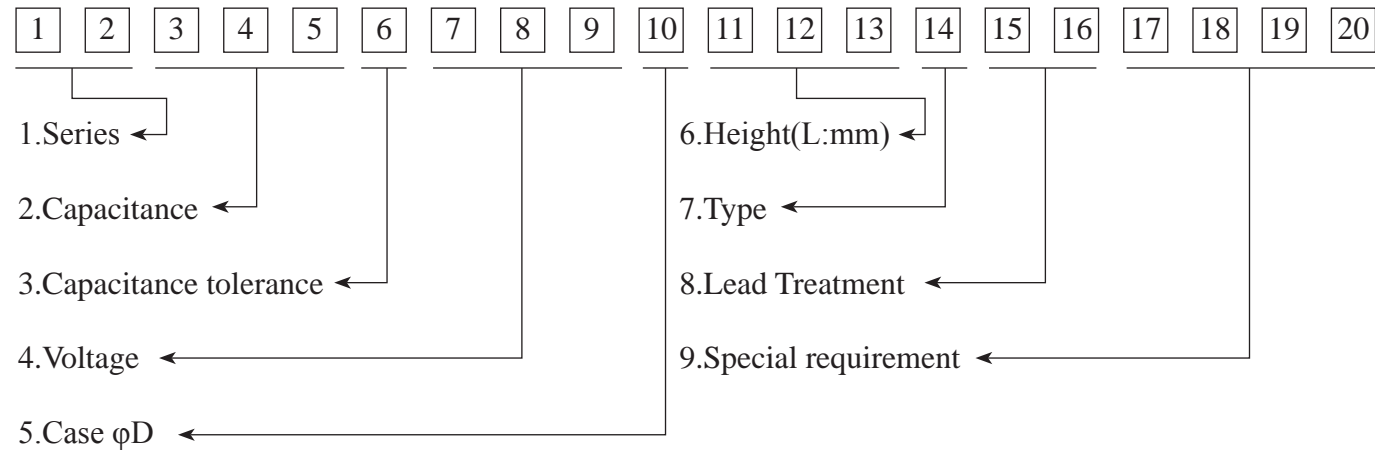

Photo flash type of Aluminum Electrolytic Capacitors



Screw type of Aluminum Electrolytic Capacitors





(1) Series

For the details, please refer to "List of the Products" on page3.

(2) Capacitance

Capacitance is shown in microfarads(uF)

μF	0.1	0.47	1	4.7	10	100	1000	10000
Code	0R1	R47	010	4R7	100	101	102	103

(3) Capacitance tolerance

Tolerance%	±5	±10	±20	±30	-10to+30	-10to+50	-10to+20	-10to100	0to+20	-30to+0	±15
Code	H	K	M	N	Q	T	V	W	Z	U	S
Tolerance%	0to+30	0to+40	0to+50	-5to+20	-8to+5	+5to+20	0to-20	-15to+20	-25to+20	-50to+0	-5to+30
Code	Y	X	A	J	E	I	B	P	L	O	C

(4) Voltage(W.V)

Voltage(W.V)	6.3	10	16	25	35	50	63	80	100	160	200	220	250	350	400	420	450	500
Code	6R3	010	016	025	035	050	063	080	100	160	200	220	250	350	400	420	450	500

(5) Case(φD)

Diameter	3	4	5	6.3	8	10	12	12.5	13	14.5	16	18	20	22	25	30	35	40	42	45	51	63.5	76.2	89	100
Code	A	B	C	E	F	G	H	Z	I	Y	J	K	L	M	N	O	P	Q	U	V	R	S	T	X	D

(6) Height(L:mm)

Description	5	5.5	5.8	6.5	7	7.7	8	8.7	9	10	10.5	11	12.5	14	16	17
Code	050	055	058	065	070	077	080	087	090	100	105	110	125	140	160	170

Description	20	25	25.5	31.5	35	35.5	41	47	52	83	98	118	141	151
Code	200	250	255	315	350	355	410	470	520	830	980	A18	A41	A51

(7) Type

Type	Without Lead Treatment	With Lead Treatment	Polymer
Code	A	E	P

(8) Lead Treatment

For the details, please refer to page10-15.

(9) Special & appearance requirement (The 17th, 18th, 19th, 20th code)

Code	Special
A	Terminal
B	Rubber
C	Lead wire
D	DF
E	Electrolyte
F	Pitch
G	Fill glue
H	Height requirement

Code	Special
I	LC
K	Vent line
L	Life
N	Nude
P	Sleeve, tray, print, PVC sleeve
Q	Capacitance, Cv, Break
R	Ripple current
S	Countermeasure

Code	Special
T	Temperature characteristic
V	Vt, Electrolyte paper
M	solder, technics, form. Case with stud
Y	clip loop
Z	Impedance
U	Package& Label

Remark:

1. If it's without lead treatment & special requirement, after the 14th code is blank
2. If it's with lead treatment & without require special requirement, the 17th 18th 19th 20th code is blank
3. If it's without lead treatment, but, with special requirement, the 15th 16th code filled with 0.
4. If it's without lead treatment, but with special requirement, also exceed 4 kinds, keystone characteristic is 4code.
5. If it's with lead treatment, but with 1 special requirement, only remark 17 code, latter three code is blank.
6. If it's with led treatment, but with 1 special requirement, and it is different from former data, the 17th is 0, the 18th code is characteristic.

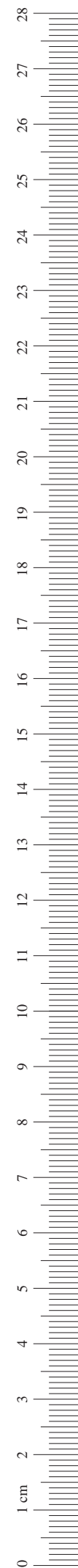

Standard

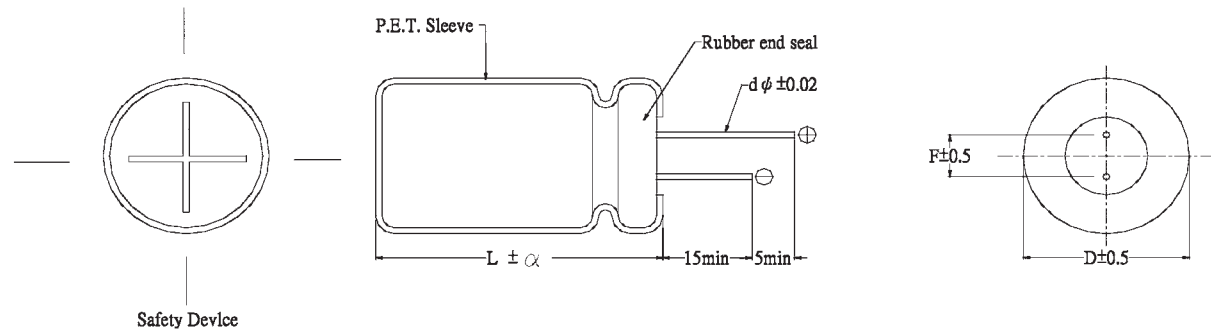

α	D < 16	D=16		D=18		D > 18
		L:25~35.5	L < 25 and L ≥ 40	L:25~31.5	L < 25 and L ≥ 35.5	
	1.5	1.5	2.0	1.5	2.0	2.0

Dφ	4	5	6.3	8	10	13	16	18	22	25
F	1.5	2.0	2.5	3.5	5.0	5.0	7.5	7.5	10	12.5
dφ	0.45	0.5		L < 20 0.5	L ≥ 20 0.6	0.6		0.8		1.0

Cutting & Forming

Part No.Code (15th, 16th)	Cutting & Forming	Size (mm)																																			
CF	<p>Fig1</p> <table border="1"> <thead> <tr> <th>Dφ</th> <th>4</th> <th>5</th> </tr> </thead> <tbody> <tr> <th>F</th> <td>2</td> <td>2.5</td> </tr> </tbody> </table> <p>*Length "H" customized</p>	Dφ	4	5	F	2	2.5	<p>Fig2</p> <table border="1"> <thead> <tr> <th>Dφ</th> <th>4</th> <th>4</th> <th>4</th> <th>5</th> <th>5</th> <th>6.3</th> <th>6.3</th> <th>8</th> <th>10</th> <th>13</th> </tr> </thead> <tbody> <tr> <th>F</th> <td>2.5</td> <td>3.5</td> <td>5</td> <td>3.5</td> <td>5</td> <td>3.5</td> <td>5</td> <td>5</td> <td>7.5</td> <td>7.5</td> </tr> </tbody> </table> <p>*Length "H" customized</p>	Dφ	4	4	4	5	5	6.3	6.3	8	10	13	F	2.5	3.5	5	3.5	5	3.5	5	5	7.5	7.5							
	Dφ	4	5																																		
F	2	2.5																																			
Dφ	4	4	4	5	5	6.3	6.3	8	10	13																											
F	2.5	3.5	5	3.5	5	3.5	5	5	7.5	7.5																											
KF	<p>Fig1</p> <table border="1"> <thead> <tr> <th>Dφ</th> <th>4</th> <th>5</th> </tr> </thead> <tbody> <tr> <th>F</th> <td>2</td> <td>2.5</td> </tr> <tr> <th>E</th> <td>1.12</td> <td>1.12</td> </tr> <tr> <th>H1</th> <td>4</td> <td>4</td> </tr> <tr> <th>H2</th> <td>1.8</td> <td>1.8</td> </tr> </tbody> </table>	Dφ	4	5	F	2	2.5	E	1.12	1.12	H1	4	4	H2	1.8	1.8	<p>Fig2</p> <table border="1"> <thead> <tr> <th>Dφ</th> <th>5</th> <th>6.3</th> <th>8</th> </tr> </thead> <tbody> <tr> <th>F</th> <td>5</td> <td>5</td> <td>5</td> </tr> <tr> <th>E</th> <td>1.12</td> <td>1.12</td> <td>1.32</td> </tr> <tr> <th>H1</th> <td>4</td> <td>4</td> <td>4</td> </tr> <tr> <th>H2</th> <td>1.8</td> <td>1.8</td> <td>1.8</td> </tr> </tbody> </table>	Dφ	5	6.3	8	F	5	5	5	E	1.12	1.12	1.32	H1	4	4	4	H2	1.8	1.8	1.8
	Dφ	4	5																																		
F	2	2.5																																			
E	1.12	1.12																																			
H1	4	4																																			
H2	1.8	1.8																																			
Dφ	5	6.3	8																																		
F	5	5	5																																		
E	1.12	1.12	1.32																																		
H1	4	4	4																																		
H2	1.8	1.8	1.8																																		

Part No.Code (15th, 16th)	Cutting & Forming	Size (mm)																																													
CA		<table border="1"> <tr> <td>Dφ</td> <td>4</td> <td>5</td> <td>6.3</td> <td>8</td> <td>10</td> <td>13</td> <td>16</td> <td>18</td> <td>22</td> <td>25</td> </tr> <tr> <td>F</td> <td>1.5</td> <td>2</td> <td>2.5</td> <td>3.5</td> <td>5</td> <td>5</td> <td>7.5</td> <td>7.5</td> <td>10</td> <td>12.5</td> </tr> </table> <p>*Length "H1" customized</p>	Dφ	4	5	6.3	8	10	13	16	18	22	25	F	1.5	2	2.5	3.5	5	5	7.5	7.5	10	12.5																							
Dφ	4	5	6.3	8	10	13	16	18	22	25																																					
F	1.5	2	2.5	3.5	5	5	7.5	7.5	10	12.5																																					
FA FB FC FD FE		<p>Fig1</p> <table border="1"> <tr> <td>Dφ</td> <td>4</td> <td>5</td> <td>6.3</td> </tr> <tr> <td>F</td> <td>2</td> <td>2.5</td> <td>3.5</td> </tr> <tr> <td>code</td> <td>FB</td> <td>FC</td> <td>FD</td> </tr> </table> <p>Fig2</p> <table border="1"> <tr> <td>Dφ</td> <td>4</td> <td>5</td> <td>6.3</td> <td>8</td> <td>10</td> <td>13</td> </tr> <tr> <td>F</td> <td>5</td> <td>5</td> <td>5</td> <td>5</td> <td>7.5</td> <td>7.5</td> </tr> <tr> <td>code</td> <td>FA</td> <td>FA</td> <td>FA</td> <td>FA</td> <td>FE</td> <td>FE</td> </tr> </table>	Dφ	4	5	6.3	F	2	2.5	3.5	code	FB	FC	FD	Dφ	4	5	6.3	8	10	13	F	5	5	5	5	7.5	7.5	code	FA	FA	FA	FA	FE	FE												
Dφ	4	5	6.3																																												
F	2	2.5	3.5																																												
code	FB	FC	FD																																												
Dφ	4	5	6.3	8	10	13																																									
F	5	5	5	5	7.5	7.5																																									
code	FA	FA	FA	FA	FE	FE																																									
CK		<table border="1"> <tr> <td>Dφ</td> <td>4</td> <td>5</td> <td>6.3</td> <td>8</td> <td>10</td> <td>13</td> <td>16</td> <td>18</td> </tr> <tr> <td>F</td> <td>1.5</td> <td>2</td> <td>2.5</td> <td>3.5</td> <td>5</td> <td>5</td> <td>7.5</td> <td>7.5</td> </tr> <tr> <td>C</td> <td>4</td> <td>4</td> <td>4</td> <td>4</td> <td>4.5</td> <td>4.5</td> <td>4.5</td> <td>4.5</td> </tr> <tr> <td>K</td> <td>4</td> <td>4</td> <td>4</td> <td>4</td> <td>4.5</td> <td>4.5</td> <td>4.5</td> <td>4.5</td> </tr> </table>	Dφ	4	5	6.3	8	10	13	16	18	F	1.5	2	2.5	3.5	5	5	7.5	7.5	C	4	4	4	4	4.5	4.5	4.5	4.5	K	4	4	4	4	4.5	4.5	4.5	4.5									
Dφ	4	5	6.3	8	10	13	16	18																																							
F	1.5	2	2.5	3.5	5	5	7.5	7.5																																							
C	4	4	4	4	4.5	4.5	4.5	4.5																																							
K	4	4	4	4	4.5	4.5	4.5	4.5																																							
KA		<table border="1"> <tr> <td>Dφ</td> <td>5</td> <td>6.3</td> <td>8</td> <td>10</td> <td>13</td> <td>16</td> <td>18</td> <td>22</td> </tr> <tr> <td>F</td> <td>2</td> <td>2.5</td> <td>3.5</td> <td>5</td> <td>5</td> <td>7.5</td> <td>7.5</td> <td>10</td> </tr> <tr> <td>E</td> <td>1.12</td> <td>1.12</td> <td>1.32</td> <td>1.32</td> <td>1.32</td> <td>1.32</td> <td>1.32</td> <td>1.82</td> </tr> <tr> <td>H1</td> <td>4</td> <td>4</td> <td>4</td> <td>4.5</td> <td>4.5</td> <td>4.5</td> <td>4.5</td> <td>4.5</td> </tr> <tr> <td>H2</td> <td>1.8</td> <td>1.8</td> <td>1.8</td> <td>1.8</td> <td>1.8</td> <td>1.8</td> <td>1.8</td> <td>1.8</td> </tr> </table>	Dφ	5	6.3	8	10	13	16	18	22	F	2	2.5	3.5	5	5	7.5	7.5	10	E	1.12	1.12	1.32	1.32	1.32	1.32	1.32	1.82	H1	4	4	4	4.5	4.5	4.5	4.5	4.5	H2	1.8	1.8	1.8	1.8	1.8	1.8	1.8	1.8
Dφ	5	6.3	8	10	13	16	18	22																																							
F	2	2.5	3.5	5	5	7.5	7.5	10																																							
E	1.12	1.12	1.32	1.32	1.32	1.32	1.32	1.82																																							
H1	4	4	4	4.5	4.5	4.5	4.5	4.5																																							
H2	1.8	1.8	1.8	1.8	1.8	1.8	1.8	1.8																																							

Part No.Code (15th, 16th)	Cutting & Forming	Size (mm)																																	
EF		<table border="1"> <tr> <td>Dφ</td> <td>4</td> <td>5</td> <td>6.3</td> <td>8</td> </tr> <tr> <td>F</td> <td>5</td> <td>5</td> <td>5</td> <td>5</td> </tr> <tr> <td>F1</td> <td>1.2</td> <td>1.2</td> <td>1.2</td> <td>1.2</td> </tr> <tr> <td>H1</td> <td>4</td> <td>4</td> <td>4</td> <td>4</td> </tr> <tr> <td>H2</td> <td>1.8</td> <td>1.8</td> <td>1.8</td> <td>1.8</td> </tr> </table>	Dφ	4	5	6.3	8	F	5	5	5	5	F1	1.2	1.2	1.2	1.2	H1	4	4	4	4	H2	1.8	1.8	1.8	1.8								
Dφ	4	5	6.3	8																															
F	5	5	5	5																															
F1	1.2	1.2	1.2	1.2																															
H1	4	4	4	4																															
H2	1.8	1.8	1.8	1.8																															
CR		<table border="1"> <tr> <td>Dφ</td> <td>4</td> <td>5</td> <td>6.3</td> <td>8</td> <td>10</td> <td>13</td> <td>16</td> <td>18</td> <td>22</td> <td>25</td> </tr> <tr> <td>F</td> <td>1.5</td> <td>2</td> <td>2.5</td> <td>3.5</td> <td>5</td> <td>5</td> <td>7.5</td> <td>7.5</td> <td>10</td> <td>12.5</td> </tr> <tr> <td>H1</td> <td>2.5</td> <td>2.5</td> <td>2.5</td> <td>2.5</td> <td>2.5</td> <td>2.5</td> <td>2.5</td> <td>2.5</td> <td>2.5</td> <td>2.5</td> </tr> </table> <p>*Length "H2" customized</p>	Dφ	4	5	6.3	8	10	13	16	18	22	25	F	1.5	2	2.5	3.5	5	5	7.5	7.5	10	12.5	H1	2.5	2.5	2.5	2.5	2.5	2.5	2.5	2.5	2.5	2.5
Dφ	4	5	6.3	8	10	13	16	18	22	25																									
F	1.5	2	2.5	3.5	5	5	7.5	7.5	10	12.5																									
H1	2.5	2.5	2.5	2.5	2.5	2.5	2.5	2.5	2.5	2.5																									
CL		<table border="1"> <tr> <td>Dφ</td> <td>4</td> <td>5</td> <td>6.3</td> <td>8</td> <td>10</td> <td>13</td> <td>16</td> <td>18</td> <td>22</td> <td>25</td> </tr> <tr> <td>F</td> <td>1.5</td> <td>2</td> <td>2.5</td> <td>3.5</td> <td>5</td> <td>5</td> <td>7.5</td> <td>7.5</td> <td>10</td> <td>12.5</td> </tr> <tr> <td>H1</td> <td>2.5</td> <td>2.5</td> <td>2.5</td> <td>2.5</td> <td>2.5</td> <td>2.5</td> <td>2.5</td> <td>2.5</td> <td>2.5</td> <td>2.5</td> </tr> </table> <p>*Length "H2" customized</p>	Dφ	4	5	6.3	8	10	13	16	18	22	25	F	1.5	2	2.5	3.5	5	5	7.5	7.5	10	12.5	H1	2.5	2.5	2.5	2.5	2.5	2.5	2.5	2.5	2.5	2.5
Dφ	4	5	6.3	8	10	13	16	18	22	25																									
F	1.5	2	2.5	3.5	5	5	7.5	7.5	10	12.5																									
H1	2.5	2.5	2.5	2.5	2.5	2.5	2.5	2.5	2.5	2.5																									
CS		<table border="1"> <tr> <td>Dφ</td> <td>4</td> <td>5</td> <td>6.3</td> <td>8</td> <td>10</td> <td>13</td> <td>16</td> <td>18</td> <td>22</td> <td>25</td> </tr> <tr> <td>F</td> <td>1.5</td> <td>2</td> <td>2.5</td> <td>3.5</td> <td>5</td> <td>5</td> <td>7.5</td> <td>7.5</td> <td>10</td> <td>12.5</td> </tr> </table> <p>*Length "H" "H1" "H2" customized</p>	Dφ	4	5	6.3	8	10	13	16	18	22	25	F	1.5	2	2.5	3.5	5	5	7.5	7.5	10	12.5											
Dφ	4	5	6.3	8	10	13	16	18	22	25																									
F	1.5	2	2.5	3.5	5	5	7.5	7.5	10	12.5																									
CZ		<table border="1"> <tr> <td>Dφ</td> <td>4</td> <td>5</td> <td>6.3</td> <td>8</td> <td>10</td> <td>13</td> <td>16</td> <td>18</td> <td>22</td> <td>25</td> </tr> <tr> <td>F</td> <td>1.5</td> <td>2</td> <td>2.5</td> <td>3.5</td> <td>5</td> <td>5</td> <td>7.5</td> <td>7.5</td> <td>10</td> <td>12.5</td> </tr> </table> <p>*Length "H" "H1" "H2" customized</p>	Dφ	4	5	6.3	8	10	13	16	18	22	25	F	1.5	2	2.5	3.5	5	5	7.5	7.5	10	12.5											
Dφ	4	5	6.3	8	10	13	16	18	22	25																									
F	1.5	2	2.5	3.5	5	5	7.5	7.5	10	12.5																									

Taping

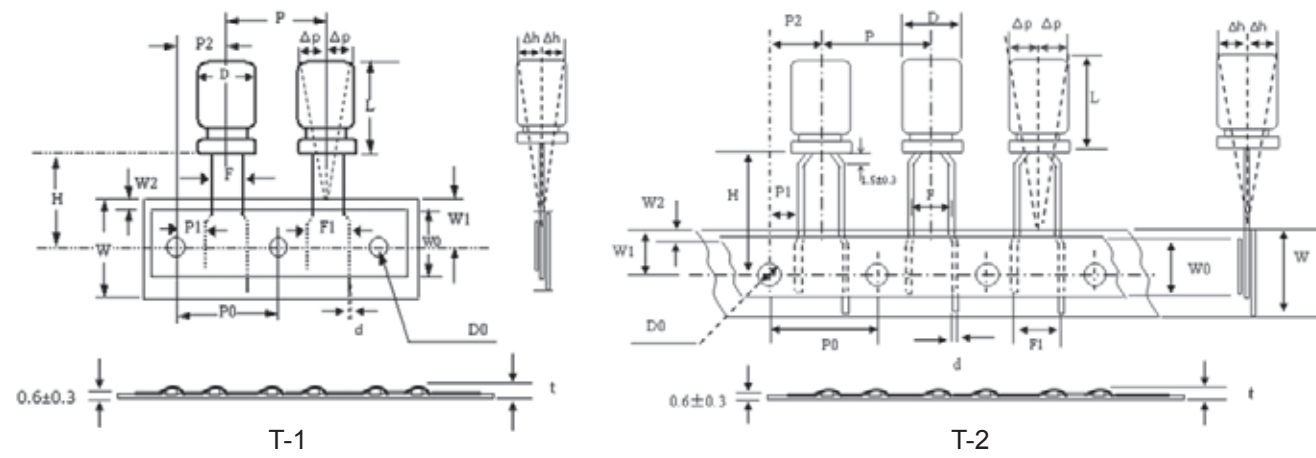

Specification Information

Code	D	L	d	P	P0	P1	P2	F	F1	W	W0	W1	W2	H	D0	Δh	ΔP	t	code	Fig
Tol.	±0.5	/	±0.02	±1.0	±0.2	±0.7	±1.3	+0.4 -0.2	±0.5	±0.5	±0.5	±0.5	Max	+0.75 -0.5	±0.2	Max	Max	Max		
Item	5	5-7(+1)	0.45	12.7	12.7	4.6	6.35	2	3.5	18	11	9	2	18.5	4	1	1	1.5	TB	T-1
		9(±2)	0.5																	
		11-15(±1.5)	0.5																	

Code	D	L	d	P	P0	P1	P2	F	F1	W	W0	W1	W2	H	D0	Δh	ΔP	t	code	Fig
Tol.	±0.5	/	±0.02	±1.0	±0.2	±0.7	±1.3	+0.4 -0.2	±0.5	±0.5	±0.5	±0.5	Max	+0.75 -0.5	±0.2	Max	Max	Max		
Item	4	5-7(+1)	0.45	12.7	12.7	4.6	6.35	2	3.5	18	11	9	2	18.5	4	1	1	1.5	TB	T-2
								2.5											TC	
								5											5-7(+1)	
Item	5	9(±2)	0.5	12.7	12.7	4.6	6.35	2.5	3.5	18	11	9	2	18.5	4	1	1	1.5	TC	
																			11-15(±1.5)	0.5

*: In this case, that is suitable for polymer.

Taping

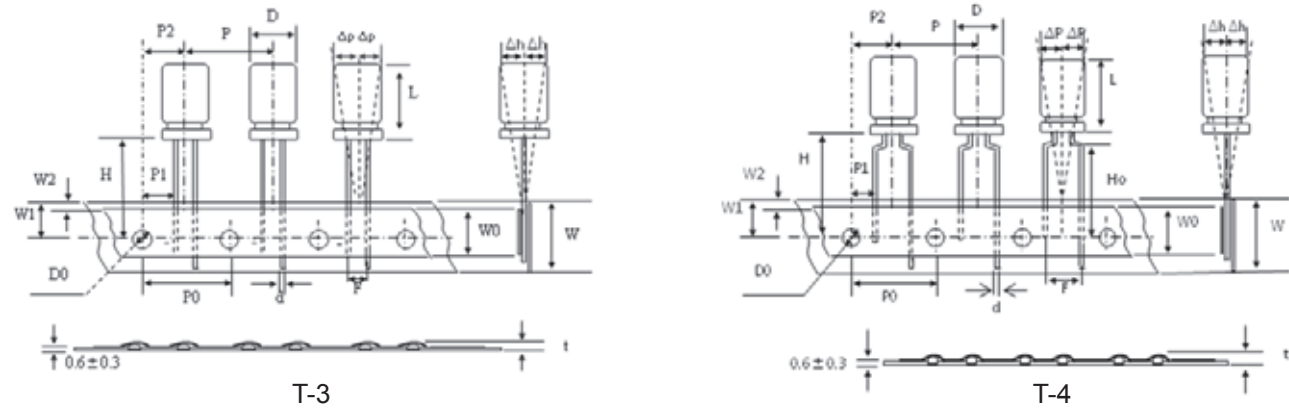

Specification Information

Code	D	L	d	P	P0	P1	P2	F	W	W0	W1	W2	H	D0	Δh	ΔP	t	code	Fig
Tol.	±0.5	/	±0.02	±1.0	±0.2	±0.7	±1.3	$\begin{matrix} +0.4 \\ -0.2 \end{matrix}$	±0.5	±0.5	±0.5	Max	$\begin{matrix} +0.75 \\ -0.5 \end{matrix}$	±0.2	Max	Max	Max		
Item	6.3	5(+1)	0.45	12.7	12.7	5.1	6.35	2.5	18	11	9	2	18.5	4	1	1	1.5	TC	T-3
		7(+1)	0.5																
		10(+1)*	0.6																
		9(±2)	0.5																
		11-15(±1.5)	0.5																
	8	5(+1)	0.45	12.7	12.7	4.6	6.35	3.5	18	11	9	2	18.5	4	1	1	1.5	TD	
		7(+1)	0.5																
		8(+1)*	0.6																
		11.5(+1.5)*	0.6																
		9(±2)	0.5																
	11.5-16(±1.5)	0.5																	
	10	7~9(±2)	0.6	12.7	12.7	3.85	6.35	5	18	11	9	2	18.5	4	1	1	1.5	TA	
		12.5-35(±1.5)	0.6																
13	13~16(+2)	0.6	15	15	5	7.5	5	18	15	9	2	18.5	4	2	2	1.5	TA		
	20-35(±1.5)	0.6																	

Code	D	L	d	P	P0	P1	P2	F	W	W0	W1	W2	H	H0	D0	Δh	ΔP	t	code	Fig
Tol.	±0.5	/	±0.02	±1.0	±0.2	±0.7	±1.3	$\begin{matrix} +0.4 \\ -0.2 \end{matrix}$	±0.5	±0.5	±0.5	Max	$\begin{matrix} +0.75 \\ -0.5 \end{matrix}$	±0.5	±0.2	Max	Max	Max		
Item	4	5-7(+1)	0.45	12.7	12.7	3.85	6.35	5	18	11	9	2	18.5	16	4	1	1	1.5	TA	T-4
		5-7(+1)	0.45																	
		9(±2)	0.5																	
	5	11-15(±1.5)	0.5	12.7	12.7	3.85	6.35	5	18	11	9	2	18.5	16	4	1	1	1.5		
		5(+1)	0.45																	
		7(+1)	0.5																	
	6.3	10(+1)*	0.6	12.7	12.7	3.85	6.35	5	18	11	9	2	18.5	16	4	1	1	1.5		
		9(±2)	0.5																	
		11-15(±1.5)	0.5																	
		5(+1)	0.45																	
	8	7(+1)	0.5	12.7	12.7	3.85	6.35	5	18	11	9	2	18.5	16	4	1	1	1.5		
		8(+1)*	0.6																	
		11.5(+1.5)*	0.6																	
9(±2)		0.5																		
11.5-16(±1.5)		0.5																		
20-25(±1.5)		0.6																		

*: In this case, that is suitable for polymer.

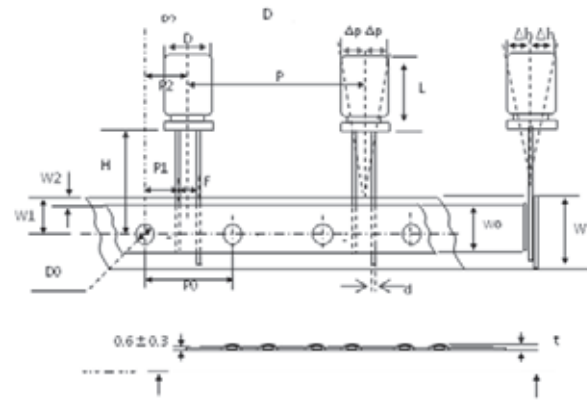

T-5

Code	D	L	d	P	P0	P1	P2	F	W	W0	W1	W2	H	D0	Δh	ΔP	t	code	Fig
	±0.5	/	±0.02	±1.0	±0.2	±0.7	±1.3	+0.4 -0.2	±0.5	±0.5	±0.5	Max	+0.75 -0.5	±0.2	Max	Min	Max		
Item	13	13~16(±2)	0.6	25.4	12.7	3.85	6.35	5	18	15	9	2	18.5	4	2	2	1.5	TA	T-5
		20~35(±1.5)	0.6		12.7	3.85	6.35	5	18	15	9	2	18.5	4	2	2	1.5	TA	
	16	16~21(±2)	0.8	30	15	3.75	7.5	7.5	18	15	9	2	18.5	4	2	2	1.5	TE	
		25~35.5(±1.5)	0.8		15	3.75	7.5	7.5	18	15	9	2	18.5	4	2	2	1.5	TE	
	18	16~21(±2)	0.8	30	15	3.75	7.5	7.5	18	15	9	2	18.5	4	2	2	1.5	TE	
		25~31.5(±1.5)	0.8		15	3.75	7.5	7.5	18	15	9	2	18.5	4	2	2	1.5	TE	
		35.5(±2)	0.8		15	3.75	7.5	7.5	18	15	9	2	18.5	4	2	2	1.5	TE	

Part Number Ammo Package

F	5	2	2.5	3.5	7.5
Code (15th, 16th)	TA	TB	TC	TD	TE

Part Number Reel Package

F	SMD
Code (15th, 16th)	TR

F	Radial				
	5	2	2.5	3.5	7.5
Code (15th, 16th)	RA	RB	RC	RD	RE

Package Information

Size	Ammo Package		
	W	A	Quantity (pcs)
4xall	227	51	2500
5xall	227	51	2000
6.3xall	227	51	1500
8x5~16	227	51	800
8x17~25	191	57	800
10x7~15	227	51	600
10x16~20	191	57	500
10x21~25	190	60	500
13x13~15	227	51	300

Size	Ammo Package		
	W	A	Quantity (pcs)
13x16~20	191	57	300
13x21~25	190	60	300
13x26~30	216	64	300
16x16~20	191	57	200
16x21~25	216	64	200
16x26~30	254	67	250
16x31~35.5	230	71	250
18x16~25	260	61	200
18x26~35.5	260	71	200

Size	Reel Package	
	AW	Quantity (pcs)
4xall	45	1800
5xall	45	1300
6.3xall	45	1000
8x5~17	45	800
8x18~28	55	800
10x7~17	45	600
10x18~28	55	600
13x13~17	45	300
13x18~28	55	300
16x13~17	45	200
16x18~28	55	200

Ammo Package

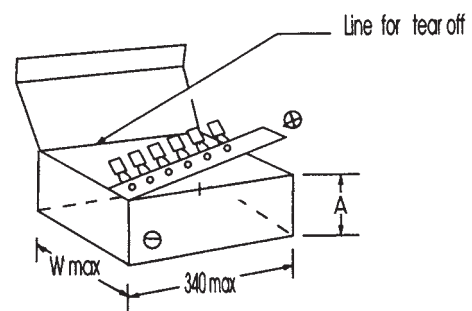

Reel Package

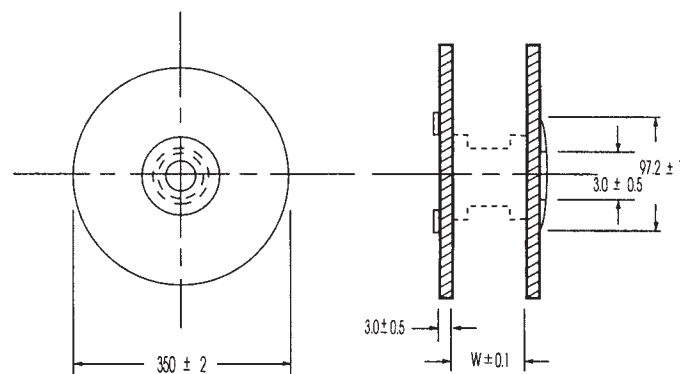

Carrier tape

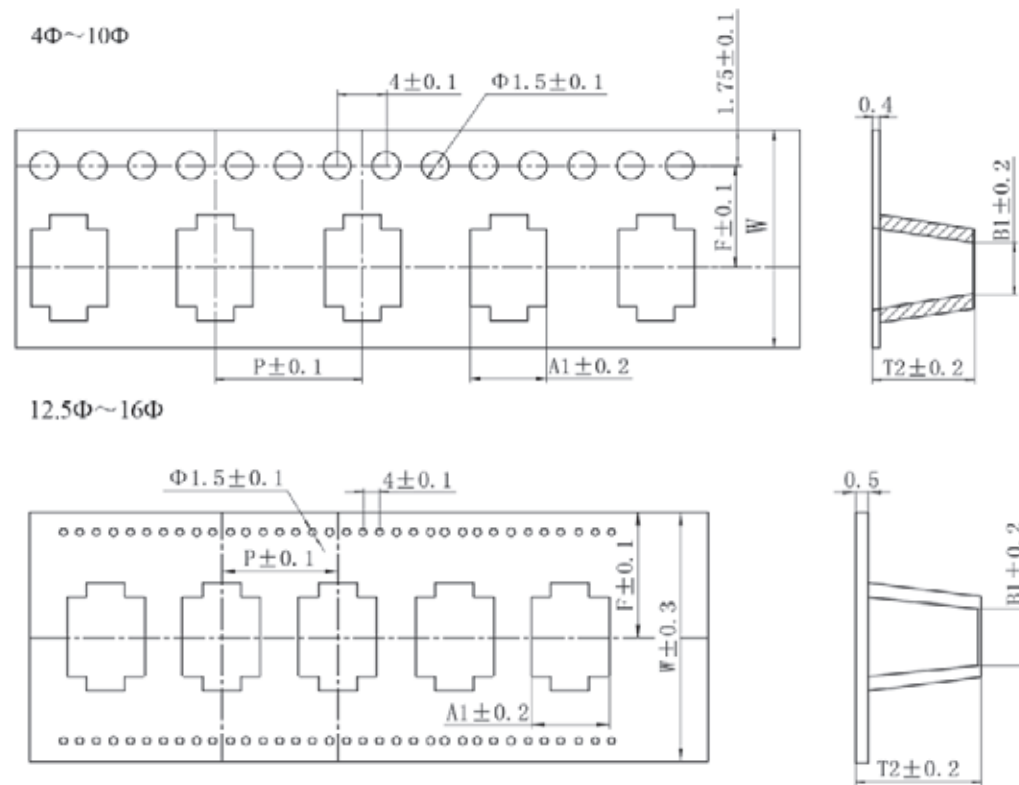

Unit: mm

φ D	4x5.5	5x5.5	5x5.8	6.3x6.1	6.3x5.5	6.3x5.8	6.3x7.7	8x6.5	8x7.7	8x8.7
W	12.0	12.0	12.0	16	16.0	16.0	16.0	16	16	24.0
P	8.0	12.0	12.0	12	12.0	12.0	12.0	12	12	16.0
F	5.5	5.5	5.5	7.5	7.5	7.5	7.5	7.5	7.5	11.5
A1	4.7	5.7	5.7	7	7.0	7.0	7.0	8.7	8.7	8.7
B1	4.7	5.7	5.7	7	7.0	7.0	7.0	8.7	8.7	8.7
T2	5.7	5.7	6.1	6.2	5.7	5.7	8.0	7.0	8.2	11.0

φ D	8x10.5	8x11.7	10x8.7	10x10.5	10x12.4	12.5x14	16x17	16x21.5	18x16.5	18x21.5
W	24.0	24.0	24	24.0	24.0	32	44	44	44	44
P	16.0	16.0	16	16.0	16.0	24	28	32	32	32
F	11.5	11.5	11.5	11.5	11.5	16	21.95	22	22	22
A1	8.7	8.7	10.7	10.7	10.7	13.9	17.5	17.5	19.9	19.9
B1	8.7	8.7	10.7	10.7	10.7	13.9	17.5	17.5	19.9	19.9
T2	11.0	13.0	11.0	11.0	12.9	14.5	17.3	23	17.5	23

Reel

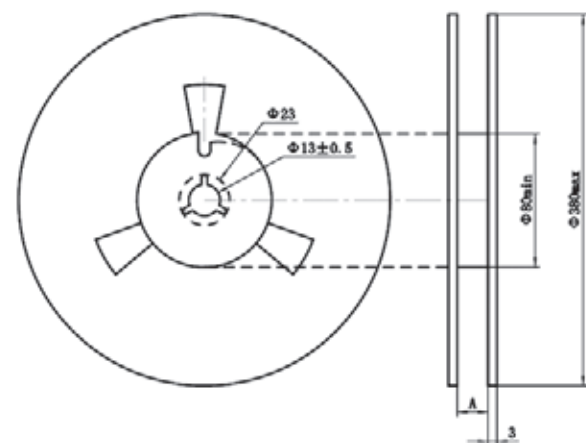

D φ	4	5	6.3, 8	8, 10	12.5	16	18
A	14	14	18	26	34	46	46

φ D	Quantity
4x5.5	2000pcs
5x5.5	1000pcs
5x5.8	1000pcs
6.3x6.1	1000pcs
6.3x5.5	1000pcs
6.3x5.8	1000pcs
6.3x7.7	900 pcs
8x6.5	1000pcs
8x7.7	700pcs
8x8.7	500pcs

φ D	Quantity
8x10.5	500pcs
8x11.7	400pcs
10x8.7	500pcs
10x10.5	500pcs
10x12.4	400pcs
12.5x14	200pcs
16x17	125pcs
16x21.5	100pcs
18x16.5	125pcs
18x21.5	100pcs

Snap-in terminal Type

Terminal Type	Terminal code	Unit: mm						
Standard	PP	<p>D=Φ22 to Φ45</p> <table border="1"> <tr> <td>H</td> <td>6</td> <td>4</td> </tr> <tr> <td>h</td> <td>2.5</td> <td>1.5</td> </tr> </table> <p>Standard H:6.0±1mm. Also available H:4.0±1mm.</p>	H	6	4	h	2.5	1.5
H	6	4						
h	2.5	1.5						
Vibration proof (T type)	CP	<p>D=Φ30 to Φ45</p> <p>Standard H:4.5±1mm. Also available H:5.5±1mm.</p>						
Vibration proof (U type)	HP	<p>D=Φ30 to Φ45</p> <p>Standard H:6±1mm.</p>						

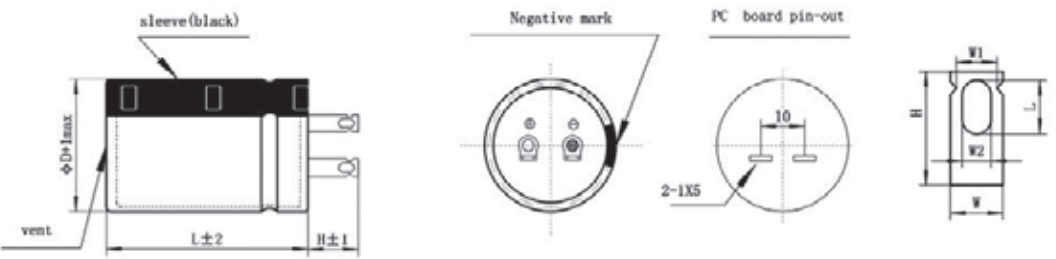
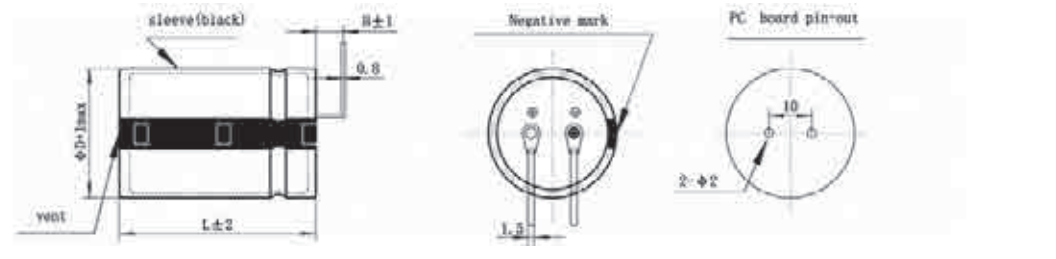
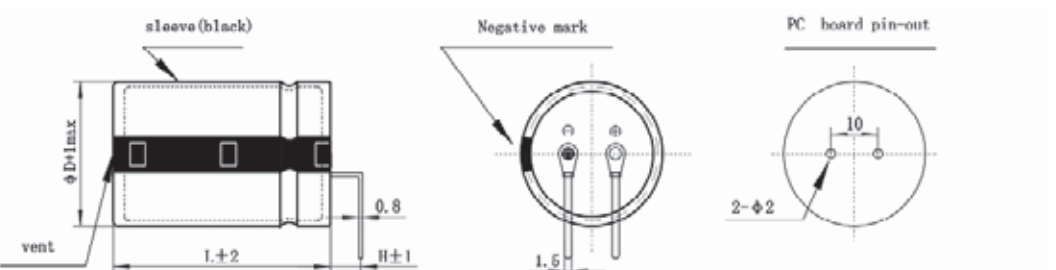
Terminal Type	Terminal code	Unit: mm
Lug Type	VP	<p>D=Φ 30 to Φ 45</p>  <p>Standard H:6±1mm. Also available H:5.0±1mm & H:12.0±1mm.</p>
Long terminal for Left bending (CL)	TP	<p>D=Φ 22 to Φ 45</p>  <p>Standard H:2.5±1mm.</p>
Long terminal for right bending (CR)	TP	<p>D=Φ 22 to Φ 45</p>  <p>Standard H:2.5±1mm.</p>

Terminal Type	Terminal code	Unit: mm						
Slim terminal	LP	<p>D=Φ22 to Φ45</p> <p>Standard H:9.5±1mm. Also available H:4.0±1mm.</p>						
3 pins terminal	ZP	<p>D=Φ22 to Φ45</p> <table border="1" data-bbox="1064 1270 1321 1328"> <tr> <td>H</td> <td>4</td> </tr> <tr> <td>h</td> <td>1.5</td> </tr> </table> <p>Standard H:4.0±1mm.</p>	H	4	h	1.5		
H	4							
h	1.5							
4 pins terminal	YP	<p>D=Φ30 to Φ45</p> <table border="1" data-bbox="937 1788 1321 1846"> <tr> <td>H</td> <td>6</td> <td>4</td> </tr> <tr> <td>h</td> <td>2.5</td> <td>1.5</td> </tr> </table> <p>Standard H:6.0±1mm. Also available H:4.0±1mm.</p>	H	6	4	h	2.5	1.5
H	6	4						
h	2.5	1.5						

Package for Snap-in type

Packing of Snap-in



Packing

Capacitor diameter D(mm)	Length L(mm)	Terminal length H(mm)	Each carton packing Qty units(pcs.)	Box/carton units(pcs.)	Each box packing Qty units(pcs.)
20	all	/	720	6	120
22	< 55	/	600	6	100
22	≥ 55	/	400	4	100
25	< 65	/	500	5	100
25	≥ 65	/	400	4	100
30	≤ 36	< 6(L=35、36)	400	8	50
30	35 ≤ L ≤ 65	≥ 6(L=35、36)	300	6	50
30	> 65	/	200	4	50
35	≤ 25	/	400	8	50
35	25 < L < 45	/	300	6	50
35	45 ≤ L ≤ 85	/	200	4	50
35	> 85	/	100	2	50
40	35	< 6	200	5	40
40	35	≥ 6	160	4	40
40	40 ≤ L ≤ 45	/	160	4	40
40	45 < L ≤ 75	/	120	3	40
40	> 75	/	80	2	40
45	40 ≤ L ≤ 65	/	140	4	35
45	65 < L ≤ 105	/	70	2	35

Series Discontinued

The following series are discontinued. Please use the replacement in the table.

▼ RADIAL TYPE REPLACEMENTS

Discontinued series	Characteristics	Replacements	Page
GR	85°C standard	GS	153
BP	Bi-polarized	Cancel	

▼ SNAP-IN TYPE REPLACEMENTS

Discontinued series	Characteristics	Replacements	Page
LS	85°C standard	LP	254
HS	105°C standard	HP	280

*Please contact us.

Already been discontinued products are not listed in this catalog.

Screw

1 Guide of Aluminum Electrolytic Capacitors.

1.1 Construction of Capacitors.

When voltage V is applied between both conducting electrodes place, a certain amount charge Q will be stored in dielectric surface by a proportional relative voltage. The proportional constant C is designating the ability of the capacitor store energy in electric field. The basic construction is as Figure 1:

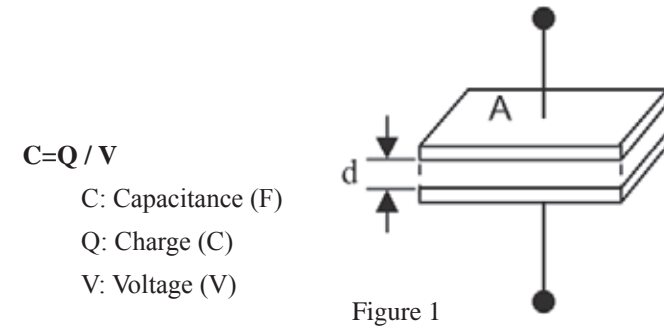

Formula of Capacitance of Capacitor

$C = \epsilon_0 * \epsilon * A / d$

C : Capacitance (F)

ϵ_0 : Absolutely Permittivity (=8.85*10⁻¹² F/m)

ϵ : Relative Permittivity

A : Surface of Capacitor Electrode (m²)

d : Space of Electrode (m)

The relative dielectric constant of the aluminum oxide membrane is 7 to 8, in order to obtain a larger capacitance, A surface area A can be increased or decreased thickness B.

Electrolytic capacitor comprising of two conductive electrodes, an anode (positive foil) and cathode (negative foil) electrodes. An insulating layer is requested to separate both electrodes. Anode if formed by an enlarged surface area of aluminum foil, Oxide membrane (Al₂O₃) will become an insulating layer on the foil Surface. Compared with other material of capacitors, cathode electrode is in charge of conductive liquid, so called electrolyte. Cathode foil is in charge of passing current to the electrolyte.

Figure 2 Cutting Construction of Aluminum Electrolytic Capacitor.

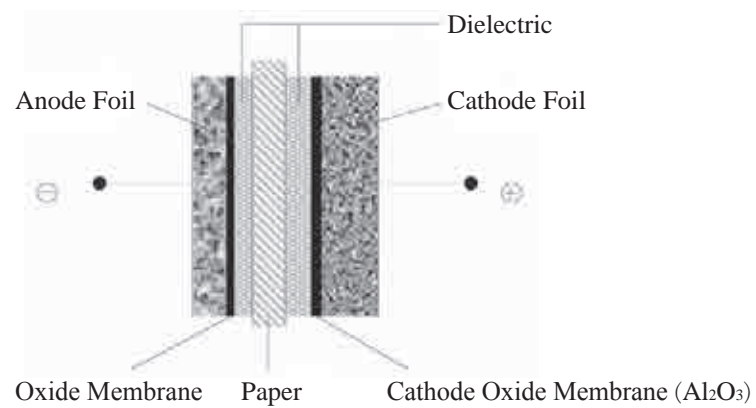
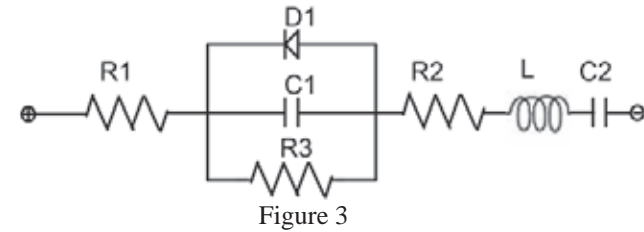

Figure 2

1.2 Equivalent Circuit of Capacitor

Figure 3: Electrical Equivalent Circuit of Aluminum Electrolytic Capacitor



- R1: Resistance of Terminal and Electrode
- R2: Resistance of Anode Oxide Layer and Electrolyte
- R3: Insulation Resistance of Defective Cathode Oxide Membrane
- D1: Oxide Semiconductor of Cathode Oxide Membrane
- C1: Anode Foil Capacitance
- C2: Cathode Foil Capacitance
- L: Inductance by Terminals and Electrodes.

1.3 Structure of Aluminum Electrolytic capacitor

Winding of Element

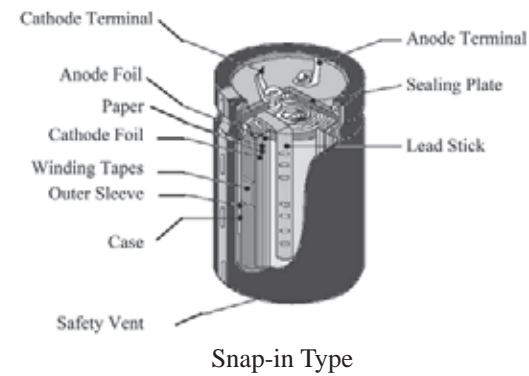

2 Definitions of Electrical Parameters

2.1 Voltage

2.1.1 Rated Voltage

Rated voltage means DC voltage and covering the peak voltage value (including pulse voltage) which may be applied continuously to a capacitor in the specified temperature range.

2.1.2 Operating Voltage

Operating voltage is covering applied continuously rated voltage to a capacitor (including superimposed AC voltage) within specified temperature range.

2.1.3 Surge Voltage

Surge voltage is the maximum voltage which applied to the capacitor value in a short period. Surge voltage is defined by JIS C 5101 as below:

$$V_R \leq 315 \text{ V} : V_S = 1.15 \text{ multiple } V_R$$

$$V_R > 315 \text{ V} : V_S = 1.10 \text{ multiple } V_R$$

2.1.4 Ripple Voltage

Voltage applied is a combination of DC and AC voltage in many product applications. Please note the following:

DC and AC voltage superimposed voltage value must less than rated voltage

Reverse voltage is not allowed. Applied ripple current must less than rated ripple current

2.1.5 Recovery Voltage

Recovery voltage is after the capacitor be discharging, a voltage between 2 terminals will be appear after some times.

Once recovery voltage is present, sparking may scare the operators during assembly, and low voltage components may also be affected. To prevent this kind of affection, use a 100Ω~1KΩ resistor to discharge the voltage and covered with a tin foil with short-circuit on 2 terminals.

2.2 Capacitance**2.2.1 AC/DC Capacitance**

In most product applications (e.g. filtering or coupling), is typically measuring AC impedance (considering the amplitude and phase) to get the AC capacitance value.

AC capacitor is considering with frequency and temperature, JIS C 5101 defined the test frequency of 100 Hz or 120 Hz, test temperature at 20 °C.

2.2.2 Calculation of Capacitance

The capacitance of anode foil dielectric portion can be calculated by the following formula:

$$C_a = 8.854 \times 10^{-12} \frac{\epsilon A}{d} \quad (\text{F})$$

ϵ : Relative Permittivity

A: Anode Surface of Capacitor (m²)

d: Space of Electrode(m)

C_c of the cathode foil is determined by the characteristics of oxide membrane. And it can be generated from a forming voltage or generated by natural growth during storage. (Typically the cathode foil oxide membrane acceptance voltage is less than 1V). The structure of aluminum electrolytic capacitors, C_a and C_c are connected together by series, so the total capacitance of the capacitor can be calculated by the following formula:

$$C = \frac{C_a \times C_c}{C_a + C_c}$$

2.2.3 Rated Capacitance

Rated capacitance is a value by designed and marked on the capacitor.

2.2.4 Tolerance of Capacitance

Capacitance tolerance is the deviation from the scope of the actual rated capacitance distribution of the capacitor.

Usually the tolerance of the standard is +20% (M), however, a tolerances +10% (K), and other special requirements of the capacitor tolerance can be also manufactured.

2.2.5 Temperature Characteristics of Capacitance

The capacitance of aluminum electrolytic capacitor will be affect with different temperature, the viscosity of electrolyte increased thus reducing the conductivity and capacitance when the temperature is decrease. The typical characteristic is as Figure 4:

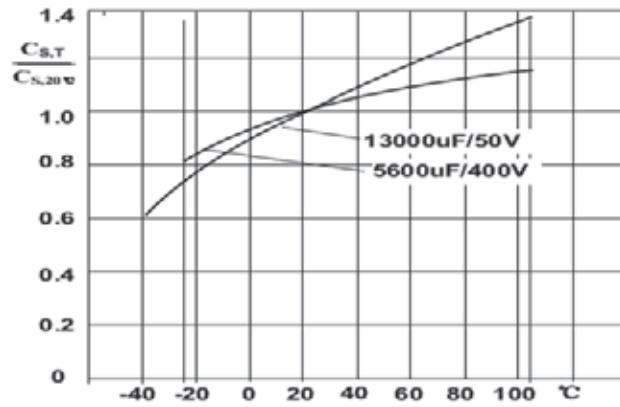

Figure 4

Cs Reference value by temperature characteristic at 20°C and 120 Hz

2.2.6 Frequency Characteristics of Capacitance

Capacitance is about to the temperature and the test frequency. As the test frequency increases, the capacity decreases. Typically frequency characteristic curve is as Figure 5.

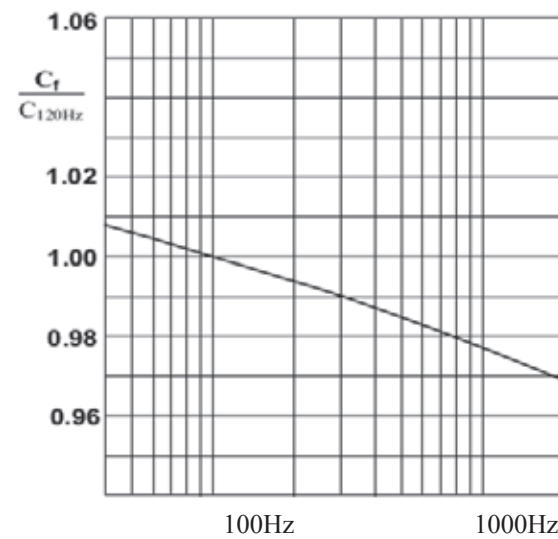

Figure 5

Capacitance C: Versus Frequency f: Typical Behavior

$$C = \frac{1}{2 \pi f Z}$$

C: Capacitance Unit : F
 f : Frequency Unit : Hz
 Z : Impedance Unit : Ω

2.3 Dissipation Factor (Tan δ), DF Value

Dissipation factor is the ratio of equivalent series resistance (ESR) to the capacitive reactance (1/ωC) in the equivalent series circuit. Aluminum electrolytic capacitors simplified equivalent circuit is as Figure 6.

Tan δ and 1/ωC, ESR series connection is as Figure 7 and by the following formula:



Figure 6

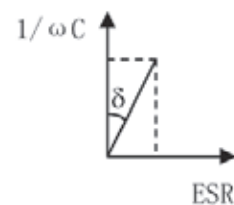

Figure 7

$$\text{Tan}\delta = \text{ESR} / (1/\omega C) = \omega * C * \text{ESR}$$

Where: ESR at 120Hz

$$\omega = 2\pi f$$

$$f = 120\text{HZ}$$

C: Series Capacitance (F)

DF (Tanδ) measured at 120Hz and 20 °C.

Tanδ becomes larger by measuring frequency increase (Figure 8), and test temperature decrease (Figure 9).

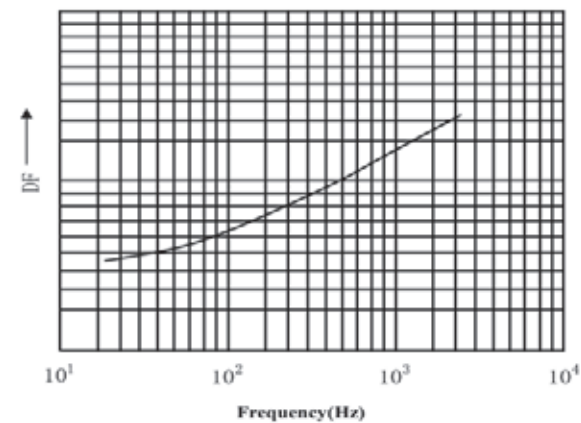

Figure 8

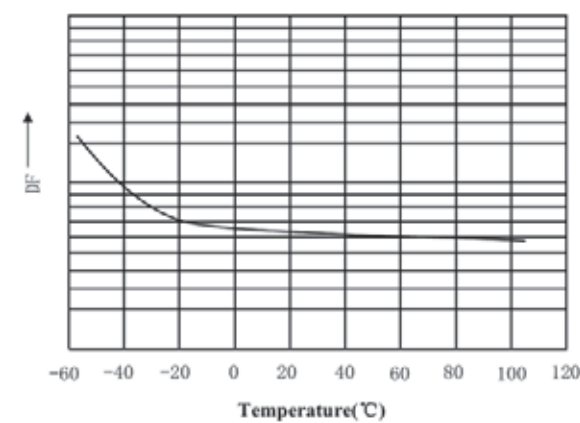

Figure 9

2.4 Equivalent Series Inductance - ESL

Equivalent series inductance represents the inductive part of the capacitors (lead terminal and internal foil). ESL is mainly affected by the frequency. The equivalent series circuit is as Figure 6.

2.5 Equivalent Series Resistance - ESR

ESR represents the losses of the capacitors. The equivalent series circuit is as figure 6. ESR is connected in series with the capacitance in the equivalent circuit. The ohm resistance of ESR is come from of electrode foil, electrolyte, the lead resistance and each internal resistance connection.

ESR decreases with increasing temperature, and also decreases with increasing frequency at low frequency.

2.6 Impedance Z

The impedance Z is the resistance which opposes the flow of alternating current in the particular frequency. It is related to capacitance and inductance which corresponds to the capacitive and inductive reactance, and also relevant with equivalent series resistance (ESR). Specific expression is as following.

$$Z = \sqrt{ESR^2 + (X_L - X_C)^2}$$

X_c: Capacitance CS Capacitive Reactance of 1/ωCS: 1/2πf*C

X_L: Inductive Reactance ωESL of Capacitor Winding and Terminals: 2πf*ESL

A typical impedance versus frequency curve is as following. The minimum impedance appears at resonant frequency and it will be equal to the ESR at same frequency.

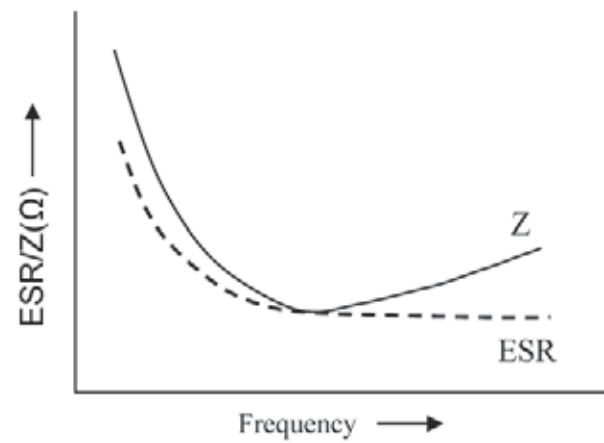

Figure 10 Impedance vs ESR vs Frequency

2.7 Leakage Current

When a DC voltage is applied through 2 terminals of the electrolytic capacitor, a small amount of current is allowed to flow into dielectric of oxide membrane. This small amount of current is called leakage current (LC).

2.7.1 Time and Temperature Characteristics of Leakage Current

As figure 11, there is a big leakage current (inrush current) flow through when capacitor is applied with voltage. With time extend, the leakage current will decrease into a stable leakage current. Thus, the leakage current (LC) is presented after a few minutes when a rated voltage is applied at temperature 20°C.

Leakage current temperature characteristics is as figure 12, larger LC at high temperature; smaller LC at low temperature.

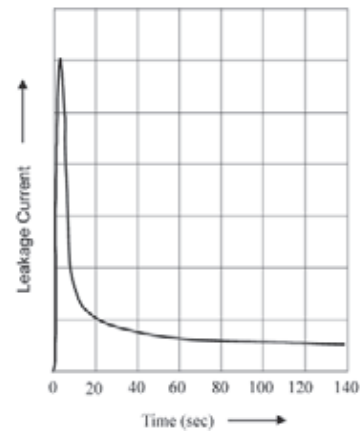

Figure 11 Time vs Leakage Current

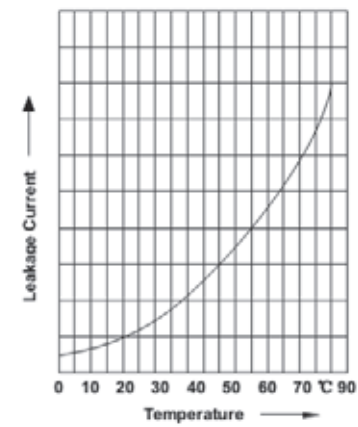

Figure 12 Temperature vs Leakage Current

2.7.2 Voltage Characteristics of Leakage Current

The effective value between leakage current and voltage of ambient temperature as figure 13.

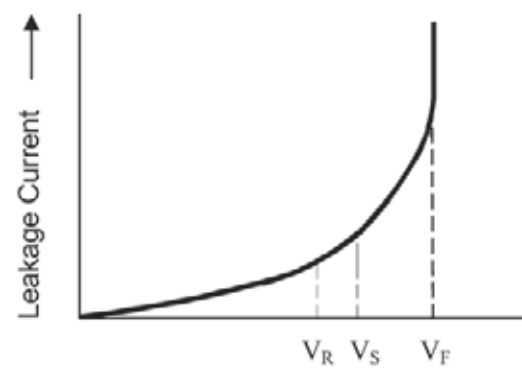

Figure 13 Leakage Current vs Voltage

2.7.3 Acceptance Test of Leakage Current

According to JIS-C-5101, following is the formula of leakage current test value after 5 minutes rated voltage applied at temperature 20 °C.

$$I_{leak} \leq 0.3\mu A * (C * V)^{0.7} + 4\mu A$$

2.7.4 The behavior of leakage current without voltage applied (non voltage storage)

Oxide membrane will be not recover thus performance reduce in a high temperature when voltage is not applied to the 2 terminals of aluminum electrolytic capacitors due to no leakage flow oxygen ions into anode foil.

The leakage current will be rise back when a long time store with non voltage applied.

Please operate of capacitors over than 1 hour after an expired storage (6 months) before using in the circuit.

This action will help oxide membrane recover and can be stored again.

3 Ripple Current

3.1 General

Ripple current is alternating current which flowing through the capacitors. Each capacitor is designed by a rated ripple current which operated under a rated operating temperature to control internal temperature of capacitors. The maximum allowable ripple current depends on the ambient temperature, capacitor surface area (thermal area), dissipation factor tanδ (or ESR) and alternating current frequency.

3.2 Frequency Dependence of Ripple Current

ESR of aluminum electrolytic capacitor will effect with frequency in a fixed voltage. Thus, ripple current is also effective with frequency.

In the most product applications, more than one frequency of ripple current could be found. In this case, we have to consider RMS of ripple current because of self-heating of capacitors is come from the combination of all ripple current of frequency as formula below:

$$I_r = \sqrt{\left(\frac{I_{r1}}{F_{r1}}\right)^2 + \left(\frac{I_{r2}}{F_{r2}}\right)^2 + \dots + \left(\frac{I_{rn}}{F_{rn}}\right)^2}$$

I_r : RMS Value of Ripple Current

$I_{r1} \dots I_{rn}$: RMS Value of Ripple Current at Frequency $f_1 \dots f_n$

$F_{r1} \dots F_{rn}$: Correction Factor of Ripple Current at Frequency $f_1 \dots f_n$

$$F_{ri} = \sqrt{\frac{ESR(f_0)}{ESR(f_i)}} \quad \text{Where } f_0 = \text{Reference Frequency of Nominal Ripple Current}$$

3.3 Temperature Dependence of Ripple Current

Capacitance of each series is given the maximum allowable ripple current under the rated temperature in category.

4 Useful Life

Useful Life (also referred to service life and operating life) is defined as the life achieved by the capacitor without exceeding the specified failure rate. The total failure or failure due parametric variation is considered to constitute the end of the useful life. Depending on the circuit design, as a failure result does not mean device failure due to parameters variation. Instead, it may consider the actual useful life will longer than the specified useful life.

Useful life is given by operating experience and accelerated aging test result. If the load is less than the rated value, useful life can be extended (E.g., lower operating voltage, current, and ambient temperature). In addition to the specified life range in category, CapXon is able to offer special useful life according to customer requested.

Screw

4.1 Load Conditions

Conditions of load useful life

Rated Voltage (the peak value of AC voltage superimposed on DC voltage should not be higher than rated voltage)

Rated Ripple Current

Rated Temperature

4.2 Operating Useful Life

Capacitor's operating useful life is calculated from each series expectation useful life.

To learn more about useful life information as below:

To calculate the ratio.

To find the intersection of calculated ratio and operating temperature.

To see the useful life value from the intersection of graph curve.

Above process does not consider the frequency characteristic of ripple current. Equivalent ripple current is calculated from the frequency corresponding to the conversion factor.

The following example illustrates the calculation procedure to use the data of a capacitor of RH series

VR	CR	Case	I_R max 120Hz 105°C (A)
450	2200	63.5X120	9.2

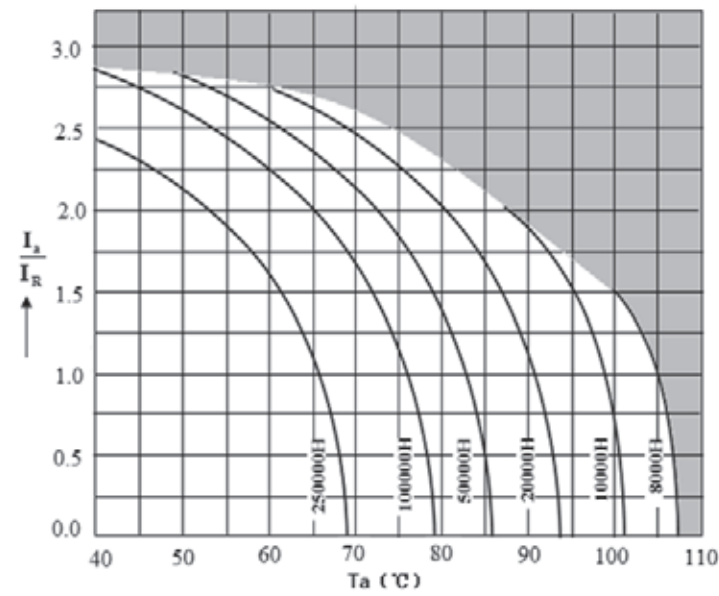

Figure 14

E.g. 1- Calculation of Useful Life

The following values are used to determine the frequency conversion. The corresponding useful life can be calculated.

Ripple Current: 25 A

Frequency: 400 Hz

Ambient: 60°C

Equivalent ripple current at 120Hz frequency converts calculations (see RH series allowable ripple current IRC frequency)

$$\frac{25A}{1.25} = 20A$$

To calculate the ratio of the actual value of the ripple current and specification values.

$$\frac{I_a}{I_R} = \frac{20A}{9.2A} = 2.2$$

Ripple current ratio and ambient temperature (60°C) on the intersection of the graph says the useful life is 100,000 hours (Figure14).

E.g. 2- Calculation of Ripple Current on Aluminum Electrolytic Capacitor

In many applications, Aluminum Electrolytic Capacitors are subjected to the ripple currents of varying frequency.

Current 1: I_{a1}, at 400Hz RMS=20A

Current 2: I_{a2}, at 4 kHz RMS=16A

Ambient: 60°C

Requested Useful Life 100000 Hours

The first step is calculating equivalent 120Hz values for the 2 current values (Frequency factors given on series RH-Frequency factor of permissible ripple current IRC) and the RMS value)

$$\text{Current I1: } \frac{20A}{1.25} = 16A$$

$$\text{Current I2: } \frac{16A}{1.32} \approx 12.12A$$

$$I_{total.RMS} = \sqrt{I_1^2 + I_2^2} = \sqrt{(16)^2 + (12.12)^2} \approx 20.07A$$

Calculation of Ripple Current Factor:

$$\frac{I_{total.RMS}}{I_{RC.R}} = \frac{20.07A}{9.5A} \approx 2.11$$

Ripple current ratio and ambient temperature (60°C) on the intersection of the graph says the useful life is 100,000 hours (Figure14).

Screw

5 Connection of Aluminum Electrolytic Capacitor

In some applications of Aluminum Electrolytic Capacitor, parallel connection and series connections and combination of parallel and series connections will be used.

5.1 Parallel Connection

Parallel connection: Current flows in equally through each unit are a necessary when parallel connection.

5.2 Series Connection

Series connection: Using balancing resistors to equally control the voltage distribution across each unit.

Operating voltage may exceed the specification value because of each single capacitors insulation is quite different and

voltage distribution may quite irregularly. Therefore, forced balancing of voltage distribution is recommended. The balancing resistance must be equal to each other, and the resistance is requested much less than insulation resistance of capacitors. As Figure15:

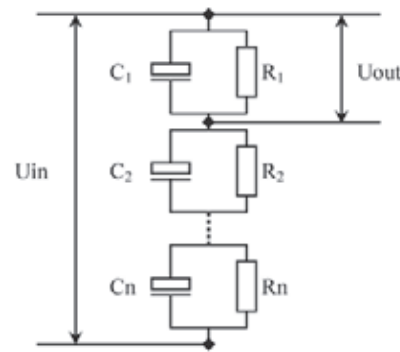

Figure 15

Formula of Equation Resistance Value:

$$R \text{ balancing resistance} = 50(m\Omega) * \mu F * (1/CR)$$

5.3 Combination of Parallel and Series Connection

Above recommended combination gives apply both in Parallel and Series circuit. It is recommended to allocate balancing resistors to each capacitor if use balancing resistors is a must. (as Figure 16)

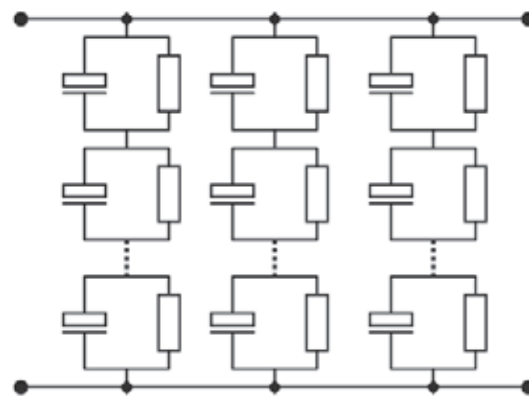

Figure 16

6 Climatic Conditions

6.1 Minimum Permissible Operation Temperature (Lower Temperature)

Aluminum Electrolytic Capacitors will increase DF values (or ESR values) when the operation temperature is decrease. Aluminum Electrolytic Capacitors will define the minimum operating temperature due to both of DF and ESR values are limited in a range for most product applications.

6.2 Maximum Permissible Operation Temperature (Upper Temperature)

Maximum permissible operation temperature is meaning the capacitors maximum operation environment temperature. Capacitors will be un-useful if operation environment is higher than category defined.

Useful life and reliability will both increase if capacitors can be used in lower operation temperature environment.

6.3 Storage Temperature

Aluminum Electrolytic Capacitors can be stored in voltage-free under category said temperature. However, it must reduce useful life and reliability easier and accelerate leakage current value if Capacitors stored in higher temperature. The oxide membrane getting worst is the mainly reason to cause abnormal circuit when Oxide membrane repaired by a larger current suddenly. Therefore, the storage temperature should not exceed 40 °C, and suggested stored at temperature 5 °C ~ 35 °C. The effective valid date of capacitors is for 1 year, please use a series resistor in 1000Ω and rated voltage to charge for 30 minutes continuously to let inside oxide membrane regeneration if storage in a long time (over 12 months) is a necessary..

7 Maintenance

A regular inspection is recommended when screw capacitors use in industrial applications. Before inspection, make sure to turn off the power and discharge screw capacitors carefully, and do not force pressure to the terminal to avoid damage.

Inspection items as below:

7.1 Outer damage, deformation and electrolyte leakage checking.

7.2 Electrical Performance: leakage current, capacitance, DF values and other product specifications subject times.

If there is an abnormal detected, make sure the capacitor specifications to replacement and handled properly.

8 Mounting

8.1 Installation

Make sure capacitor's rated capacitance, rated voltage and polarity before installation.

Please confirmed capacitors and circuit board terminal pitch is consistent before installation. It may cause stress to internal capacitor through the terminal to cause short if the pitch is different.

Robotic force pressure and lead bending strength has to be controlled properly when automatically mounting.

Mounting Position of Screw Capacitors

To avoid screw capacitor explosion when capacitance safety vent is opened while capacitance reached a certain exhaust gas pressure, the screw capacitors should not be mounted with the safety vent upside down. Recommended mounting method is shown as Figure17 to avoid safety vent down installation.

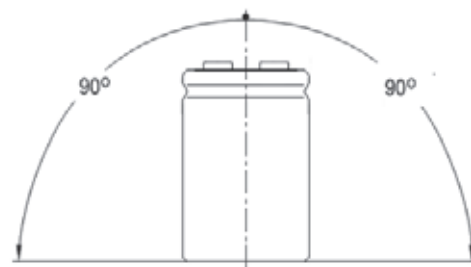

Figure 17

Recommended range of mounting positions

Horizontal Mounting Request

Anode terminal in upper side with safety vent in horizontal as Figure18.

Safety vent in upper side with Anode and Cathode terminal in horizontal as Figure19.

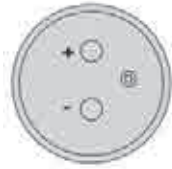

Figure 18



Figure 19

It may not damage capacitors directly but an electrolyte leakage may happen if install by other mounting methods.

8.2 Soldering**8.2.1 Before Soldering**

Soldering conditions (preheat, solder temperature and immersion time, frequency) must be completed in the limited range to prevent the performance of capacitors.

When circuit board terminal pitch does not match with capacitors terminal pitch, please do not force extra pressure to capacitor when an extra treatment is necessary.

To avoid treating capacitor body with a soldering iron to prevent sleeve holes and other damage;

To avoid capacitor body dipped in soldering, solder heat will cause the capacitor damage due to internal pressure arise.

8.2.2 After Soldering

After soldering into PCB, do not external forces or pull capacitor body, to prevent the extra pressure to damage the part through the terminal into internal body to cause part short.

8.3 Cleaning Agents

Please use available cleaning agents to clean circuit boards under temperature 50°C within 5 minutes after soldering

Cleaning agent must be strictly managed, such as pollution, chlorine concentration may be increased, result to an internal capacitor corrosion.

After cleaning, must be dry immediately, to avoid cleaning agent remains between sealing portion and circuit board.

Do not use below solvents to clean the capacitance:

Halogen-containing solvents: halogen solvents penetrate (diffuse) into the internal capacitance, will cause cleaning agent decomposition reaction of free chlorine ions, react with the aluminum to cause capacitor corrosion.

Alkaline solvent: corrosion aluminum case

Xylene: sealing rubber oxidation

Acetone: description words blur or disappear

9 Outer Sleeve of Capacitors

Outer sleeve and outer plate does not guarantee electrical insulation function, description only.

10. Marking of Capacitors

Marking Content of Screw Type:solvent.

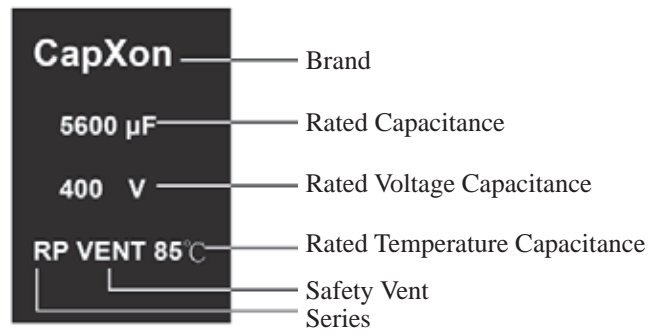

Screw

Corporate goals

We adhere to the tenet of "QUALITY FIRST", and offer satisfying products and service to the customer. This aim is shared by the CapXon quality and environment management system:

1 CapXon quality system

1.1 CapXon quality policy and environment policy

We adhere to the tenet of "QUALITY FIRST", and offer satisfying products and service to the customer.

1.2 Quality management system

The quality management system to IATF 16949:2016 is applied throughout the company and is used to implement the CapXon quality policy.

The implications include:

As a rule, product and process developments follow the rules of APQP),

Quality tools such as FMEA), MSA) and SPC) minimize risks and ensure continuous improvements in conjunction with regular internal audits and QM reviews.

1.3 Certification

The CapXon quality management system forms the basis for the company certification to ISO 9001:2015 and IATF 16949:2016 that comprises the CapXon plants and sales organizations.

1.4 Delivery quality

“Delivery quality” means compliance with the agreed data at the time of delivery.

1.5 Failure criteria

A component is defective if one of its features does not correspond to the specification of the data sheet or an agreed delivery specification. Failure criteria please refer to Defective degree evaluation and handling method of reliability experiment.

1.6 Incoming goods inspection at the customer

We recommend the use of a random sampling plan according to MIL-STD-1916 (contents compliant with MIL STD 105 D and IEC 60410) for incoming goods inspection. The test methods to be used are laid down in the relevant standards. Deviations must be agreed by the customer and the supplier.

1.7 Duration of use

The service life in terms of reliability is the time period during which random failures occur, i.e. the range in the product operating life in which the failure rate remains largely constant (early failures and end of operating life excepted). The value depends strongly on conditions of use.

1.7.1 Failure rate (long-term failure rate)

The failure rate is defined as the failure percentage divided by a specified operating period. The failure rate is expressed in fit (failures in 10⁹ component hours) or as percentage of failures in 1000 hours.

1 fit = 1 x 10⁻⁹/h (fit = failure in time)

Example of a failure rate test determined by a useful life test:

1. Number of components tested N = 10000

2. Operating hours t_b = 20000 h

3. Number of failures n = 2

$$\lambda_{\text{test}} = \frac{n}{N} * \frac{1}{t_b} = \frac{2}{10000} * \frac{1}{20000\text{H}} = 10\text{FIT} = 0.001\%/1000\text{H}$$

Failure rate specifications must include failure criteria, operating conditions and ambient conditions. Usually the failure rate of components, when plotted against time, shows a characteristic curve with the following three periods:

I: early failure period, II: useful period, III: wear-out failure period

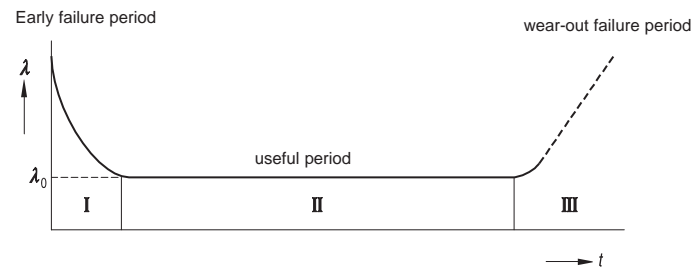

Unless otherwise specified, the failure rate refers to the useful period (II). During this period, an approximately constant failure rate λ_0 can be assumed.

1.8 AQL values

The AQL (AQL= acceptable quality level) figures are based on a random sampling plan to MIL-STD-1916.

The sampling instructions of this standard are such that a delivered lot will be accepted with a probability of 90% if the percentage of non-conformancies does not exceed the stated AQL figure. As a rule, the percentage of non-conformancies in deliveries from CapXon is significantly below the AQL figure. The acceptance value we apply to inoperatives, i.e. unusable components is $c=0$.

2 Environmental management system

2.1 Environmental policy

CapXon defines the following environmental protection principles:

Comply with the law, Govern the pollution, Produce Cleanly, Reduce the consume, Save resource, Cut down the toxic substance, Make Improvement Continuously, Beautify the environment

2.2 Environmental management system

The CapXon ISO 14001 based environmental management system is applied company wide for implementing the CapXon environmental policy. It is posted on the CapXon Intranet and is thus accessible to all employees.

2.3 Environmental Hazardous Substances Free management system

The CapXon QC080000 based HSF management system is applied company wide for implementing the CapXon environmental Hazardous Substances management. that Capxon products effectively in the management of hazardous substances.

2.4 Energy Management System

CapXon establishes comprehensive energy use management in accordance with the requirements of ISO 50001

Energy Management System in order to meet the social responsibility of low carbon environmental protection and efficiency.

2.5 Certification

2.5.1 The CapXon Group operates an environmental management system that conforms to the requirements of ISO 14001 and is mandatory for all plants. The CapXon Group operates an Energy management system that conforms to the requirements of ISO 50001 and is mandatory for all plants. The CapXon Group operates an environmental Hazardous Substances Free management system that conforms to the requirements of QC 080000 and is mandatory for all plants. The company certificate is posted on the CapXon internet: (www.capxongroup.com).

2.5.2 SONY GP certification: On Nov 2011, CAPXON have already got the SONY GP certification.GP NO.:FC012746

2.5.3 C-ROHS certification: On Dec 2012, CAPXON have already got the C-ROHS certification. products type: SMD type, Snap-in type and Radial type.

2.6 RoHS

The term “RoHS-compatible” shall mean the following:

The components described as “RoHS-compatible” are compatible with the requirements of the regulations listed below (“Regulations”) and with the requirements of the provisions which will result from transformation of the Regulations into national law to the extent such provisions reflect the Regulations:

Directive 2002/95/EC of the European Parliament and of the Council of January 27, 2003 on the restriction of the use of certain hazardous substances in electrical and electronic equipment

("Directive 2002/95/EC");The directive from July 1, 2006 entered into force.

Commission Decision of 1 August 18, 2005 amending Directive 2002/95/EC (2005/618/EC); Commission Decision of October 13, 2005 and of October 21, 2005 amending the Annex to Directive 2002/95/EC (2005/717/EC, 2005/747/EC, 2006/310/EC, 2006/690 .692/EC).

December 3, 2008 The European Commission published its official Web site of the RoHS directive revised draft COM (2008) 809 / 4.

September 3, 2009 RoHS EU issued a revised second draft Directive COM (2008) 809final.

October 22, 2009 EU Environment Public Health and Food Safety Committee (Committee on the environment, public health and food safety) released on COM (2008) 809 of the amendments.

July 1, 2011,the European Parliament and Council issued directive 2011/65/EU(ROHS.2.0) in the official Journal of the European Union to replace the 2002/95/EC. The new directive has been fully implemented on January 1,2013, the old directive 2002/95/EC has been abolished.

RoHS Directive, also known as Amendment RoHS 2.0, the amendment involves a lot of content. But the basic objectives and mechanisms have not been changes, the ultimate goal still is to reduce the electrical and electronic products of certain hazardous substances.

The instruction modified to increase 4 to be "priority review" the use of substances HBCDD, DEHP, DBP and BBP.

2.7 Halogen Free(HF)

Base on customer and environmental regulations on the management and control requirements of halogen , such as the European 2002-95-EC, IEC 61249-2-1, "Montreal Protocol on Substances that Deplete the Ozone Layer", "Controls the Stockholm joint pledge about durable organic pollutant", CapXon has imported halogen-free materials of all electrolytic capacitors completely at the beginning of 1st,June,2009. All products shipped meet the halogen-free requirements on 31th,Oct,2009.

2.8 Banned and Environmental Hazardous Substances in components

As a manufacturer of passive components, we develop our products on the basis of sustainability.

In order to guarantee a standardized procedure for CapXon Group, a mandatory list of Environmental Hazardous Substances of special interest is part of our environmental management system. The planning and development instructions include regulations and guidelines that aim to identify environmental aspects and to optimize products and processes with respect to material use and environmental compliance, to design them with sparing use of resources and to substitute hazardous substances as far as possible.

In consideration of the environmental aspects are checked and recorded in the design reviews: the environmental officer provides support in the assessment of the environmental impacts of a development project.

2.9 Product Series and Specifications for product catalog

CapXon Product Series and Specifications on the Internet (www.capxongroup.com), It is available to refer to check for customers.

2.10 Disposal

All aluminum electrolytic capacitors can be disposed off, reused or recycled. However as disposal is regulated by national law, the respective national provisions have to be observed.

For Conductive Polymer Capacitors

CP-CAP is a solid aluminum capacitor with conductive polymer electrolyte. Please read the following points in order to take the most out of your CP-CAP.

Designing device circuits

1. Circuits where CP-CAPs are prohibited to use

The leakage current of conductive polymer solid aluminum capacitors may vary depending on thermal stresses. Please don't use solid capacitors in the following types of circuits:

- (1) High-impedance circuits that are to sustain voltages.
- (2) Coupling circuits
- (3) Time constant circuits

In addition to the leakage current fluctuation, capacitance may also fluctuate depending on operational temperature and humidity. The fluctuation of the capacitance may cause problem if it is used as a time constant capacitor, which is extremely sensitive to the fluctuation of the capacitance. Do not use it as a time constant capacitance.

- (4) Other circuits that are significantly affected by leakage current. If you want to use 2 or more CP-CAPs in a series connection, please contact us before use.

2. Polarity

The CP-CAP is a polarized solid aluminum electrolytic capacitor. Do not apply either reverse voltages or AC voltages to the polarized capacitors, using reverse polarity may cause a short circuit. Refer to the catalog, product specifications or capacitor body to confirm the polarity prior to use.

3. Applied voltage

Do not apply DC voltages exceeding the full rated voltage. The peak voltage of superimposed AC voltages (ripple voltages) on DC voltages must not exceed the full rated voltage. While there are specifications for surge voltages exceeding the rated voltage, usage conditions apply, and continued operation for extended periods of time under such conditions cannot be guaranteed. Use the within 20% of the rated voltage for applications which may cause the reverse voltage during the transient phenomena when the power is turned off or the source is switched.

4. Ripple current

Do not apply currents in excess of the rated ripple current.

The superimposition of a large ripple current increases the rate of heating within the capacitor. This may reduce the service life of the capacitor or damage the capacitor.

5. Operating temperature

Do not use the CP-CAP at high temperatures (temperatures exceeding the maximum temperature for the capacitor category) Use of the capacitor outside of the maximum temperature for the capacitor category may decrease the service life of the capacitor.

6. Sudden charge and discharge

Do not use the CP-CAP in circuits where the capacitor is repetitively charged and discharged rapidly. Repetitively charging and discharging the capacitor rapidly may reduce the capacitance or may cause damage due to internal heating. Use of a protective circuit to ensure reliability is recommended when rush currents exceed 10A or the rush current is over 10 times of allowable ripple current of CP-CAP.

A protection resistor (1 k Ω) must be inserted to the circuit during the charge and discharge when measuring the leakage current.

7. Failures and life-span

The CP-CAP failure rate in use is based on the failure rate level in the specification requirements. Upper category temperature and category voltage adhere to JIS C 5003 Standard. The confidence level is 60% and the failure rate is 0.5%/1,000 hours (applied rated voltage at category temperature).

The failure modes mainly have 2 types as follows.

(1) Contingency failure

The contingency failure mainly has short circuit. The phenomenon of after short is on following.

- (i) In the event a short circuit causes the current to become relatively small (less than approximately 1A for $\phi 10$, less than approximately 0.5A for $\phi 8$ and less than approximately 0.2A for smaller than $\phi 6.3$), the CP-CAP itself will generate a little heat, but its appearance will not be affected even when electricity is supplied continuously. However, if the short circuit current value exceeds the mentioned values above, the temperature inside the CP-CAP will increase, the internal pressure is raised, rubber sealing is turned over, and odorous gas is released. In this case, keep your face and

hands away from the area.

- (ii) The electrolyte, electrolytic paper, sealing rubber, and plastic spacer used in the CP-CAP are all combustible. If an extremely large electric current flows through the capacitor after shorting, the shorted part may spark, and in a worst case scenario, may ignite. Ensure safety by fully considering the design issues described below when using this capacitor in equipment where safety is a priority.

- Increase safety by using in conjunction with a protective circuit or protective equipment.
- Install measures such as redundant circuits so that the failure of a part of the equipment will not cause unstable operation.

(2) Performance characteristic and failure (life-span)

CP-CAP characteristics can possibly change (capacitance reduction and ESR increase) within the specified range in specifications when it is used in the condition of rated voltage, electric and mechanical performance.

When life span exceeded the specified guarantee time of endurance and damp heat, electric characteristic might change and cause electrolyte insulation. This is called open circuit mode. It is recommended to use the capacitor at a lower temperature than the maximum temperature for the capacitor category.

8. Circuit design

Verify the following before designing the circuit:

- (1) The electrical characteristics of the capacitor will vary depending on differences in temperature and frequency. Only design your after verifying the scope of these factors.
- (2) When connecting two or more capacitors in parallel, ensure that the design takes current balancing into account.
- (3) When two or more capacitors are connected in series, variability in applied voltage may cause over-voltage conditions. Contact CapXon before using capacitors connected in series.

9. Capacitor usage environment

Do not use/expose capacitors to the following conditions.

- (1) Oil, water, salty water, take care to avoid storage in

damp locations.

- (2) Direct sunlight
- (3) Toxic gases such as hydrogen, sulfide, sulfurous acids, nitrous acids, chlorine and chlorine compounds, bromine and bromine compounds, ammonia, etc.
- (4) Ozone, ultraviolet rays and radiation.
- (5) Severe vibration or mechanical shock conditions beyond the limits advised in the product specification section of the catalog.

10. Capacitor mounting

- (1) For the surface mount capacitor, design the copper pads on the PC board in accordance with the catalog or the product specification
- (2) For radial capacitors, design the terminal holes on the PC board to fit the terminal pitch of the capacitor.

11. Leakage current

Heat pressure from soldering and mechanical stress from transportation may cause the leakage current to become large. In such a case, leakage current will gradually decrease by applying voltage less than or equal to the rated voltage at a temperature within the upper category temperature. In close conditions to the upper category temperature, the nearer the applied voltage is to the rated voltage, the faster the leakage current recovery speed is.

Mounting precautions

1. Note

- (1) For the surface mount capacitor, design the copper pads on the PC board in accordance with the catalog or the product specification
- (2) For radial capacitors, design the terminal holes on the PC board to fit the terminal pitch of the capacitor.
- (3) Mount after checking the capacitance and the rated voltage.
- (4) Mount after checking the polarity.
- (5) Do not apply excessive external force to the lead terminal and the CP-CAP itself.
- (6) Ensure that the soldering conditions meet the specifications recommended by CapXon. Note that the leakage current may increase due to thermal stresses that occur during soldering, etc. Note that increased leakage currents gradually decrease when voltage is applied.

2. Soldering using a soldering iron:

- (1) The soldering conditions (temperature and time) are within the ranges specified in the catalog or product specifications.
- (2) The tip of the soldering iron does not come into contact with the capacitor itself.

3. Flow soldering

- (1) Do not dip the body of a capacitor into the solder bath only dip the terminals in. The soldering must be done on the reverse side of PC board.
- (2) Soldering conditions (preheat, solder temperature and dipping time) should be within the limits prescribed in the catalog or the product specifications.

In regards to flow soldering, be sure to solder within the following conditions.

	Temperature	Duration	Flow number
Preheating	120°C or less (ambient temperature)	120 sec. or less	1 time
Soldering conditions	260+5°C or less	10+1 sec. or less	Twice or less

- (3) Do not apply flux to any part of capacitors other than their terminals.
- (4) Make sure the capacitors do not come into contact with any other components while soldering.

4. Reflow soldering

- (1) Soldering conditions (preheat, solder temperature and soldering time) should be within the limits prescribed in the catalogs or the product specification.
- (2) The heat level should be appropriate. (Note that the thermal stress on the capacitor varies depending on the type and position of the heater in the reflow oven.)
- (3) Vapor phase soldering (VPS) is not used.
- (4) Except for the surface mount type, reflow soldering must not be used for the capacitors.
- (5) In the case of reflow soldering, capacitive static electricity may decrease after soldering even when the soldering conditions are within the required values.
- (6) Recommended reflow condition of SMD type.

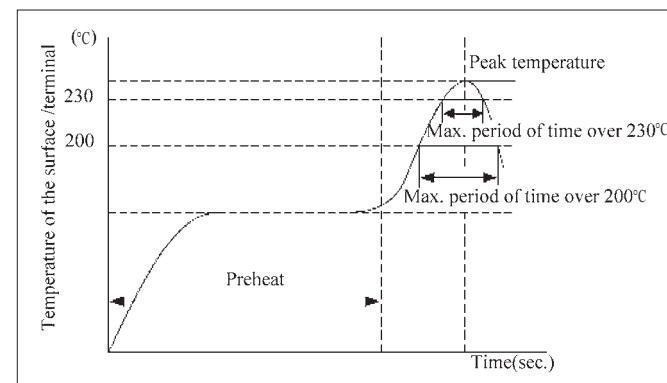

Voltage range	Preheat	Time maintained above 200°C	Time maintained above 230°C	Peak temp.	Reflow number
2.5 to 10v	150 to 180°C 120 sec. max.	90 sec. max.	60 sec. max.	260°C max	only 1 time
16 to 25v		90 sec. max.	60 sec. max.	250°C max	twice or less
		80 sec. max.	50 sec. max.	240°C max	only 1 time
35 to 100v		70 sec. max.	30 sec. max.	240°C max	twice or less

Note : 1) All temperatures are measured on the topside of the Al-case and terminal surface.
 2) The second reflow soldering shall be applied after the temperature of capacitors decreases down to the room temperature.

The leakage current value may increase (from a few μA to a few mA) even within the above conditions. When the CP-CAP is used in a DC circuit, the leakage current will decrease gradually through self-recovery after voltage is applied. If your reflow profile deviates from the above conditions for mounting the CP-CAP, please consult with CapXon.

5. Handling after soldering

Do not apply any mechanical stress to the capacitor after soldering onto the PC board.

- (1) Do not lean or twist the body of the capacitor after soldering the capacitors onto the PC board
- (2) Do not use the capacitors for lifting or carrying the assembly board.
- (3) Do not hit or poke the capacitor after soldering to PC board. When stacking the assembly board, be careful that other components do not touch the aluminum electrolytic capacitors.
- (4) Do not drop the assembled board.

6. Washing the PC boards

- (1) Do not wash capacitors by using the following cleaning agents. Solvent resistant capacitors are only suitable for washing using the cleaning conditions prescribed in the catalog or the product specification. In particular, ultrasonic cleaning will accelerate damage to capacitors.

- Halogenated solvents; cause capacitors to fail due to corrosion.
Alkali system solvents; corrode (dissolve) an aluminum case.
- Petroleum system solvents; cause the rubber seal material to deteriorate.
- Xylene; causes the rubber seal material to deteriorate.
- Acetone; erases the markings.

- (2) Verify the following points when washing capacitors.
 - Monitor conductivity, pH, specific gravity and the water content of cleaning agents. Contamination adversely affects these characteristics.
 - Be sure not to expose the capacitors under solvent rich conditions or keep capacitors inside a closed container. In addition, please dry the solvent sufficiently on the PC board and the capacitor

with an air knife (temperature should be less than the maximum rated category temperature of the capacitor) for 10 minutes. Aluminum electrolytic capacitors can be characteristically and catastrophically damaged by halogen ions, particularly by chlorine ions, though the degree of the damage mainly depends upon the characteristics of the electrolyte and rubber seal material. When halogen ions come into contact with the capacitors, the foil corrodes when a voltage is applied. This corrosion causes an extremely high leakage current which results venting and an open circuit.

Storage

The following conditions for storage are recommend.

- (1) Store capacitors in a cool, dry place. Store at a temperature between 5 and 35°C, with a humidity of 75% or less. SMD products are sealed in a special laminated aluminum bag. Use all capacitors once the bag is opened. Return unused capacitors to the bag, and seal it with a zipper. Be sure to follow our recommendations for reflow soldering.
- (2) Store the capacitors in a location free from direct contact with water, salt water, and oil.
- (3) Store in a location where the capacitor is not exposed to toxic gas, such as hydrogen sulfide, sulfurous acid, nitrous acid, chlorine or chlorine compounds, bromine or other halogen gases, methyl bromide or other halogen compounds, ammonia, or similar.
- (4) Store in a location where the capacitor is not exposed to ozone, ultraviolet radiation, or other radiation.
- (5) It is recommended to store capacitors in their original packaging wherever possible.

For Aluminum Electrolytic Capacitors

When you use aluminum electrolytic capacitors, remember the following.

1.Polarity

- Regular electrolytic Capacitor has polarity.
- Reverse voltage causes short circuit breakage of the capacitor or leakage of electrolyte. Where the polarity in a circuit sometimes reversed or unknown, a bi-polar capacitor should be used.

2.Overvoltage

- Do not apply overvoltage continuously.
- When overvoltage is applied to the capacitor, leakage current increase drastically.
- Applied working voltage to capacitors should not exceed the rated working voltage of capacitor.

3.Operating temperature and life:

- Do not use the capacitor over the max operating temperature.
- Life time of the capacitor depends on the temperature.
- Generally, life time is doubled by decreasing each temperature 10°C.
- Use temperature as low as possible.

4.Vent

- It is recommended at least 3mm of space around the vent.
- If such space is not provided, the vent will not operate completely.

5.Ripple current

- Do not apply a ripple current exceeding the rated maximum ripple current.
- Applying too much ripple current to the capacitor causes great heat generation, invites deterioration of properties of cases breakage.
- Please consult factory if ripple current exceeds the specified limit.

6.Charge and discharging

- Frequent and quick charge/discharge generates heat inside the capacitor, causing increase of leakage current, decrease of capacitance, or breakage occasionally.
- Consult us for assistance in this application.

使用鋁電解電容器注意事項：

1.極性

鋁電解電容器一般是有極性的，極性反接是造成鋁電解電容器短路損壞及漏液的原因，因此在無法辨識電氣迴路上之極性或使用於有極性變換設計之迴路時，請選用無極性電解電容器。

2.過載

請勿連續施加過載電壓。當電壓過載時電解電容器的漏電流會急速增加，所以電解電容器之工作電壓不應超過額定值。

3.使用溫度和壽命

電解電容器之使用溫度請勿超出最高使用溫度之設定範圍。電解電容器的壽命取決於使用溫度，一般來說當電解電容器之使用溫度降低10°C時，其壽命將增為兩倍，因此電解電容器應儘可能在較低溫度下使用。

4.防爆孔

有防爆孔設計之電解電容器其使用時防爆孔側應與其它機構保持最少3mm以上之空間距離，如此條件不能滿足的話，防爆孔將無法正常運作。

5.紋波電流

請勿施加超過額定最高紋波電流容許值以上之紋波電流。施加過大紋波電流將使電解電容器的內溫異常上升，引起電解電容器電氣特性劣化及破損。如有需要施加額定值以上之紋波電流等要求時，請諮詢敝廠人員。

6.充放電

經常及快速的充放電將使電容器之內溫異常上升，使漏電流增加、容量降低，有時還會造成產品之損壞，如對充放電有特殊要求時請諮詢敝廠人員。

7.Storage

- When the capacitor is stored for a long time without applying voltage, leakage current tends to increase.
- This returns to normal by applying the rated voltage to the capacitor before use.
- It is recommended to apply D.C. working voltage to the capacitor for 30 minutes through 1KΩ of protective series resistor, if it is stored for more than 12 months.
- The capacitor should be stored at temperature 5°C to 35°C, with humidity of 75% or less.

7.電解電容器的儲存

當電解電容器經過長時間之放置後，通常其漏電流有增大之傾向。因此在使用經過長時間放置後之電解電容器以前，建議需先施加定額電壓使其電氣特性回復正常；如儲存時間長於12個月以上時，請串排1kΩ之保護電阻後，使其持續負載定額工作電壓30分鐘。另外電解電容器應儲存於溫度介於5°C~35°C及濕度75%或以下之環境。

8.For SMD Soldering

- Improper soldering may shrink or break the insulating sleeve and/or damage the internal element as terminals and lead wires conduct heat into the capacitor.
- Avoid too high a soldering temperature and/or too long a soldering time.
- Solderability 245±5°C, 2±0.5 secs, 95% coverage min.

8.SMD焊

不適當的焊錫溫度及時間可能造成表面膠管之異常收縮破裂，有時高溫也會藉由導針及端子導熱至素子內部，對產品造成不良影響，因此須儘量避免過高溫度及過長時間之焊錫。
 焊接性：245±5°C, 2±0.5 秒, 表面大於95%範圍附著錫。

9. Reflow soldering of SMD

Soldering Heat Resistance as below Temperature profile

9.SMD回流焊

耐焊接熱如下溫度曲線

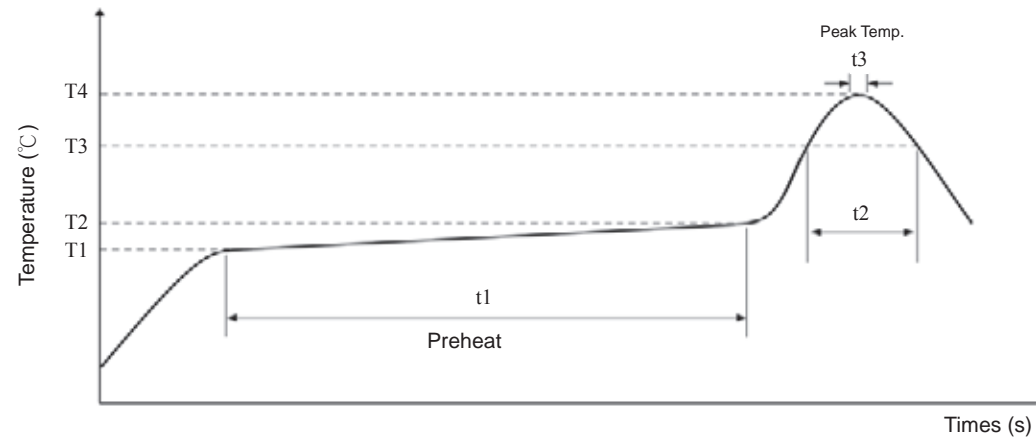

Size	Voltage	Preheat		Time maintained above 230°C		Peak temp.		Reflow number
		Temp.(T1~T2)	Time(t1)	Temp.(T3)	Time (t2)	Temp.(T4)	Time (t3)	
φ3~ φ6.3	4 to 50V	150°C to 180°C	120sec. max.	above 230°C	30 sec. max	260°C max.	10 sec.	2 times or less
	63 to 100V			above 230°C	30 sec. max	255°C max.	5 sec.	2 times or less
φ8~ φ10	4 to 50V			above 230°C	30 sec. max	250°C max.	5 sec.	2 times or less
	63 to 450V			above 230°C	30 sec. max	240°C max.	5 sec.	2 times or less
φ12.5~ φ18	4 to 50V			above 230°C	20 sec. max.	245°C max	5 sec.	2 times or less
	63 to 450V			above 230°C	-	235°C max	5 sec.	2 times or less

10. Mechanical stress on the lead wire and the terminal

- Do not apply excessive force to the lead wire and the terminal.
- Do not move the capacitor after soldering to the PC board, not carry the PC board by picking up the capacitor.

11. Cleaning of boards after soldering

- If the capacitor is cleaned in halogenated solvent for organic removing solder flux solvent, the solvent may penetrate into the inside of capacitor, and may generate corrosion.

12. Sleeve material

- The standard sleeve material is polyethylene terephthalate.
- If exposed to xylene, toluene, etc, and then subjected to high heat, the sleeve may crack. This sleeve is not insulating material.

13. CapXon's Products meet quality standards specified by JIS-C-5101-1 and the reliability requirements refer to JIS-C-5101-4(non-SMD liquid capacitor), -18(Liquid SMD capacitor), -25(solid SMD capacitor), -26(solid Radial capacitor).

14. None of ozone depleting chemicals (ODC) under the Montreal Protocol is used in manufacturing process of CapXon Electronic Industrial CO., Ltd.

15. About AEC-Q200

The Automotive Electronics Council(AEC) , was setup by American major automotive manufactures, which now are an industry committees consist of various manufacturers of electrical equipment and spare components .It's also responsible for the standardization of reliability test and standard test of electronic components.

AEC-Q200 is the reliability test standard for the determination of passive components, which specifies the test items and the number of test items for various components, including the reliability test standard for aluminum electrolytic capacitors.

For the increasing number of aluminum electrolytic capacitors for on-board use in recent years, our company can provide the experimental results according to the requirements of the guests, corresponding to AEC-Q200.

10. 導針與端子之機械強度

請勿施加過度之外力於導針及端子上。請勿扳開已焊接於PC板上之電解電容器，更不要以電解電容器為施力點提起或移動整塊PC板。

11. 焊錫後之基板清洗

如使用鹵化有機溶劑清洗基板，溶劑有可能滲進電解電容器內部引起腐蝕。

12. 套管材料

一般使用之塑膠套膠材質多為聚對苯二甲酸乙二酯（PET），如塑膠膠管在浸漬二甲苯或甲苯後再放置於高溫下，將產生分解反應，膠管將失去絕緣功能。

13. 本公司之產品品質符合JIS-C-5101-1指定標準，其信賴性試驗方法依JIS-C-5101-4(非SMD液態電容)，-18（液態SMD電容），-25(固態SMD電容)，-26（固態導針型電容）之規範為基準。

14. 本公司依蒙特利爾協議書之規定，於生產過程中不使用破壞臭氧層之藥品。

15. AEC是車載電子零部件評議會的簡稱，是由美國主要汽車製造商設立，現在由電裝，零部件各製造公司構成的行業團體。負責電子零部件的可靠性試驗及認定標準試驗的標準化工作。

AEC-Q200是被動元器件的認定用可靠性試驗標準，規定了各類元器件的試驗專案及試驗數量等，其中也規定了鋁電解電容器的可靠性試驗標準。

對於近年來逐漸增多的用於車載用途的鋁電解電容器，我公司可對應AEC-Q200，根據客人的要求提供實驗結果。詳情另外諮詢。

PL series Low ESR $\leq 9m\Omega$

Features

- ◆ Very Low ESR at high frequency range.
- ◆ Very Large permissible ripple current.



Specifications

Items	Performance Characteristics	
Operating Temperature Range	-55°C~+105°C	
Rated Voltage Range	2.5~16V DC	
Capacitance Range	180 to 3500 μ F	
Capacitance Tolerance	$\pm 20\%$ (120Hz · +20°C)	
Leakage Current (+20°C · max)	Not to exceed the values shown in Standard Ratings (Rated voltage applied, after 2 minutes at 20°C)	
Dissipation Factor (tan δ · at 20°C · 120Hz)	Not to exceed the values shown in Standard Ratings	
ESR (at 100KHz · 20°C)	Not to exceed the values shown in Standard Ratings	
Endurance 105°C · 2000h · at rated voltage	Capacitance Change	Within $\pm 20\%$ of the value before test
	Leakage current	Not to exceed the value specified
	ESR	Not to exceed 150% of the value specified
	Dissipation Factor	Not to exceed 150% of the value specified
Moisture Resistance Stored at 60°C · RH90~95% · 1000h	Capacitance Change	Within $\pm 20\%$ of the value before test
	Leakage Current	Not to exceed the value specified
	ESR	Not to exceed 150% of the value specified
	Dissipation Factor	Not to exceed 150% of the value specified

Frequency Coefficient for Ripple Current

Frequency	120Hz \leq freq. < 1KHz	1KHz \leq freq. < 10KHz	10KHz \leq freq. < 100KHz	100KHz \leq freq. < 300KHz
Coefficient	0.05	0.3	0.7	1

Diagram of Dimensions:(unit:mm)

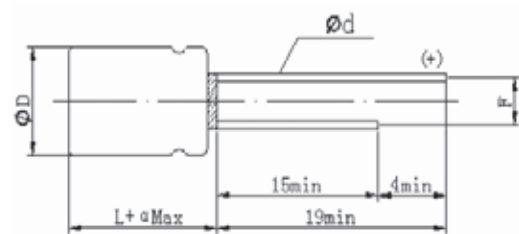

ϕ DxL	ϕ D+0.5	α	F ± 0.5	ϕ d ± 0.05
8x8	8.0	1.0	3.5	0.6
8x11.5	8.0	1.5	3.5	0.6
10x12.5	10.0	1.5	5.0	0.6

Standard Ratings

W.V. (V)	Cap(μF)	Size φ DxL(mm)	L.C. (μA,2min)	tg δ (120Hz,20°C)	ESR (mΩ),100KHz	Maximum Permissible Ripple Current(mA,r.m.s)
2.5	560	8x8	280	0.08	9	6100
		8x11.5	280	0.08	9	6100
	680	8x8	340	0.08	9	6100
		8x11.5	340	0.08	9	6100
	820	8x8	410	0.08	9	6100
		8x11.5	410	0.08	9	6100
	1000	8x8	500	0.08	9	6100
		8x11.5	500	0.08	9	6100
	1200	8x8	600	0.08	9	6100
		8x11.5	600	0.08	9	6100
	1500	8x8	750	0.08	9	6100
		8x11.5	750	0.08	9	6100
	1800	8x8	900	0.08	9	6100
	2000	8x11.5	1000	0.08	9	6100
		10x12.5	1000	0.08	9	6640
2500	10x12.5	1250	0.08	9	6640	
2700	10x12.5	1350	0.08	9	6640	
3000	10x12.5	1500	0.08	9	6640	
3300	10x12.5	1650	0.08	9	6640	
3500	10x12.5	1750	0.08	9	6640	
4	560	8x8	224	0.08	9	6100
		8x11.5	225	0.08	9	6100
	680	8x8	272	0.08	9	6100
		8x11.5	272	0.08	9	6100
	820	8x8	328	0.08	9	6100
		8x11.5	328	0.08	9	6100
		10x12.5	328	0.08	9	6100
	1000	8x8	800	0.08	9	6100
		8x11.5	800	0.08	9	6100
	1200	8x8	960	0.08	9	6100
		8x11.5	860	0.08	9	6100
		10x12.5	860	0.08	9	6640
	1500	8x11.5	1200	0.08	9	6100
		10x12.5	1200	0.08	9	6640
	1800	8x11.5	1440	0.08	9	6500
2000	10x12.5	1600	0.08	9	6640	
2500	10x12.5	1500	0.08	9	6640	
6.3	180	8x8	226.8	0.07	9	6100
		8x11.5	226.8	0.07	9	6100
	220	8x8	277	0.07	9	6100
		8x11.5	277	0.07	9	6100
	270	8x8	340.2	0.07	9	6100
		8x11.5	340.2	0.07	9	6100
	330	8x8	416	0.07	9	6100
		8x11.5	416	0.07	9	6100
	390	8x8	491.4	0.08	9	6100
		8x11.5	491.4	0.08	9	6100
	470	8x8	592	0.08	9	6100
		8x11.5	592	0.08	9	6100
	560	8x8	705.6	0.08	9	6100
		8x11.5	705.6	0.08	9	6100
	680	8x8	428.4	0.08	9	6100
8x11.5		428.4	0.08	9	6100	

Ripple Current(mA,rms)at 105°C,100KHz

W.V. (V)	Cap(μF)	Size φ DxL(mm)	L.C. (μA,2min)	tg δ (120Hz,20°C)	ESR (mΩ,100KHz)	Maximum Permissible Ripple Current(mA,r.m.s)
6.3	820	8x8	516.6	0.10	9	6100
		8x11.5	514.6	0.10	9	6100
	1000	8x8	630	0.10	9	6100
		8x11.5	630	0.10	9	6100
		10x12.5	630	0.10	9	6640
	1200	8x8	756	0.10	9	6100
		8x11.5	756	0.10	9	6100
		10x12.5	756	0.10	9	6640
	1500	8x11.5	945	0.10	9	6100
		10x12.5	945	0.10	9	6640
2000	10x12.5	1260	0.10	9	6640	
2200	10x12.5	1336	0.10	9	6640	
2500	10x12.5	1575	0.10	9	6640	
10	180	8x8	360	0.07	9	5600
		8x11.5	360	0.07	9	6100
	220	8x8	440	0.08	9	5600
		8x11.5	440	0.08	9	6100
	270	8x8	540	0.08	9	5600
		8x11.5	540	0.08	9	6100
	330	8x8	660	0.08	9	5600
		8x11.5	660	0.08	9	6100
	390	8x8	780	0.08	9	5600
		8x11.5	780	0.08	9	6100
	470	8x8	940	0.08	9	5600
		8x11.5	940	0.08	9	6100
	560	8x8	560	0.10	9	5600
		8x11.5	560	0.10	9	6100
	680	8x8	680	0.10	9	5600
		8x11.5	680	0.10	9	5600
	680	10x12.5	680	0.10	9	6100
		8x11.5	820	0.10	9	5600
	820	10x12.5	820	0.10	9	6100
		8x11.5	1000	0.10	9	5600
1000	10x12.5	1000	0.10	9	6100	
	10x12.5	1200	0.10	9	6100	
1500	10x12.5	1500	0.10	9	6100	
16	180	8x11.5	576	0.08	9	5600
	220	8x11.5	704	0.08	9	5600
	270	8x8	864	0.08	9	5600
		8x11.5	864	0.08	9	5600
	330	8x8	528	0.08	9	5600
		8x11.5	528	0.08	9	5600
	330	10x12.5	528	0.08	9	6100
		8x11.5	624	0.08	9	5600
	390	10x12.5	624	0.08	9	6100
		8x11.5	752	0.10	9	5600
	470	10x12.5	752	0.10	9	6100
		8x11.5	896	0.10	9	5600
	560	10x12.5	896	0.10	9	6100
		680	10x12.5	1000	0.10	9
820	10x12.5	1280	0.10	9	6100	
1000	10x12.5	1600	0.10	9	6100	

Ripple Current(mA,rms)at 105°C,100KHz

PS series Standard Products

Features

- ◆ Low ESR at high frequency range.
- ◆ Large permissible ripple current.



Conductive Polymer

Specifications

Item	Performance Characteristics	
Operating Temperature Range	-55°C~+105°C	
Rated Voltage Range	2.5~25 VDC	
Capacitance Range	39 to 3500 μF	
Capacitance Tolerance	±20%(120Hz,+20°C)	
Leakage Current (+20°C,max.)	Not to exceed the values shown in Standard Ratings (Rated voltage applied, after 2 minutes at 20°C)	
Dissipation Factor (tan δ , at 20°C , 120Hz)	Not to exceed the values shown in Standard Ratings	
ESR (at 100KHz , 20°C)	Not to exceed the values shown in Standard Ratings	
Endurance 105°C , 2000h , at rated voltage	Capacitance Change	Within ±20% of the value before test
	Leakage current	Not to exceed the value specified
	ESR	Not to exceed 150% of the value specified
	Dissipation Factor	Not to exceed 150% of the value specified
Moisture Resistance Stored at 60°C , RH90~95% , 1000h	Capacitance Change	Within ±20% of the value before test
	Leakage current	Not to exceed the value specified
	ESR	Not to exceed 150% of the value specified
	Dissipation Factor	Not to exceed 150% of the value specified

Frequency Coefficient for Ripple Current

Frequency	120Hz ≦ freq. < 1KHz	1KHz ≦ freq. < 10KHz	10KHz ≦ freq. < 100KHz	100KHz ≦ freq. < 300KHz
Coefficient	0.05	0.3	0.7	1

Diagram of Dimensions:(unit:mm)

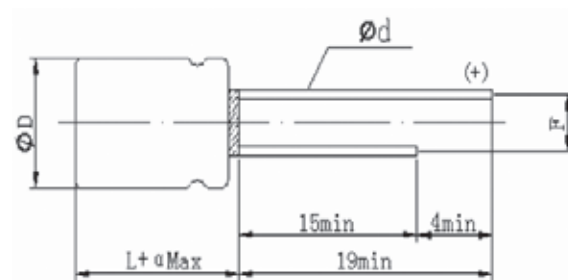

φ DxL	φ D+0.5	α	F ± 0.5	φ d ± 0.05
8x8	8.0	1.0	3.5	0.6
8x11.5	8.0	1.5	3.5	0.6
10x12.5	10.0	1.5	5.0	0.6

Standard Ratings

W.V. (V)	Cap(μF)	Size φ DxL(mm)	L.C. (μA,2min)	tg δ (120Hz,20°C)	ESR (mΩ),100KHz)	Maximum Permissible Ripple Current(mA,r.m.s)
2.5	560	8x8	280	0.08	12	5100
		8x11.5	280	0.08	12	5100
	680	8x8	340	0.08	12	5200
		8x11.5	340	0.08	12	5200
	820	8x8	410	0.08	12	5200
		8x11.5	410	0.08	12	5200
	1000	8x8	500	0.08	12	5500
		8x11.5	500	0.08	12	5500
	1200	8x8	600	0.08	12	5500
		8x11.5	600	0.08	12	5500
	1500	8x8	750	0.08	12	5500
		8x11.5	750	0.08	12	5500
	2000	8x11.5	1000	0.08	12	5900
		10x12.5	1000	0.08	12	5900
2200	10x12.5	1100	0.08	12	5900	
2500	10x12.5	1250	0.08	12	5900	
2700	10x12.5	1350	0.08	12	5900	
3000	10x12.5	1500	0.08	12	5900	
3300	10x12.5	1650	0.08	12	5900	
3500	10x12.5	1750	0.10	12	5900	
4	560	8x8	448	0.08	12	5100
		8x11.5	448	0.08	12	5200
	680	8x8	544	0.08	12	5100
		8x11.5	544	0.08	12	5200
	820	8x8	656	0.08	12	5100
		8x11.5	656	0.08	12	5200
		10x12.5	656	0.08	12	5900
	1000	8x8	800	0.10	12	5100
		8x11.5	800	0.10	12	5500
		10x12.5	800	0.10	12	5900
	1200	8x11.5	960	0.10	12	5500
		10x12.5	960	0.10	12	5900
	1500	8x11.5	600	0.10	12	5500
		10x12.5	600	0.10	12	5900
2000	10x12.5	800	0.10	12	5900	
2200	10x12.5	880	0.10	12	5900	
2500	10x12.5	1000	0.10	12	5900	
6.3	180	8x8	226.8	0.07	21	5100
		8x11.5	226.8	0.07	21	5100
	220	8x8	277.2	0.07	21	5100
		8x11.5	277.2	0.07	21	5100
	270	8x8	340.2	0.07	21	5100
		8x11.5	340.2	0.07	21	5100
	330	8x8	415.8	0.07	15	5100
		8x11.5	415.8	0.07	15	5500
	390	8x8	491.4	0.08	15	5100
		8x11.5	491.4	0.08	15	5500
	470	8x8	592.2	0.08	12	5100
		8x11.5	592.2	0.08	12	5500
	560	8x8	705.6	0.08	12	5100
		8x11.5	705.6	0.08	12	5500
	680	8x8	428.4	0.08	10	5100
		8x11.5	428.4	0.08	12	5500
		10x12.5	428.4	0.08	12	5900
	820	8x8	516.6	0.10	12	5100
8x11.5		516.6	0.10	12	5500	
10x12.5		516.6	0.10	12	5900	
1000	8x8	630	0.10	12	5100	
	8x11.5	630	0.10	12	5500	
	10x12.5	630	0.10	12	5900	

Ripple Current(mA,rms)at 105°C,100KHz

Standard Ratings

W.V. (V)	Cap(μF)	Size φ DxL(mm)	L.C. (μA,2min)	tg δ (120Hz,20°C)	ESR (mΩ),100KHz)	Maximum Permissible Ripple Current(mA,r.m.s)
6.3	1200	8x11.5	756	0.10	12	5500
		10x12.5	756	0.10	12	5900
	1500	8x11.5	945	0.10	12	5500
		10x12.5	945	0.10	12	5900
	2000	10x12.5	1260	0.10	12	5900
	2200	10x12.5	1386	0.10	12	5900
2500	10x12.5	1575	0.10	12	5900	
10	180	8x8	180	0.08	15	5100
		8x11.5	180	0.08	15	5500
	220	8x8	220	0.08	15	5100
		8x11.5	220	0.08	15	5500
	270	8x8	270	0.08	15	5100
		8x11.5	270	0.08	15	5500
	330	8x8	330	0.08	12	5100
		8x11.5	330	0.08	12	5500
	390	8x8	390	0.08	12	5100
		8x11.5	390	0.08	12	5500
	470	8x8	470	0.08	12	5500
		8x11.5	470	0.08	12	5500
	560	8x8	560	0.08	12	5500
		8x11.5	560	0.08	12	5500
	680	8x8	680	0.10	12	5500
		8x11.5	680	0.10	12	5900
	820	10x12.5	680	0.10	12	5900
		8x11.5	820	0.10	12	5900
1000	10x12.5	820	0.10	12	5900	
	8x11.5	1000	0.10	12	5900	
1200	10x12.5	1000	0.10	12	5900	
1500	10x12.5	1200	0.10	12	5900	
16	100	8x11.5	1500	0.10	12	5900
	100	8x11.5	160	0.08	12	4800
		8x8	240	0.08	12	4500
	150	8x8	288	0.08	15	4500
		8x11.5	288	0.08	15	4800
	180	8x8	352	0.08	15	4500
		8x11.5	352	0.08	15	5000
	220	8x8	432	0.08	12	4500
		8x11.5	432	0.08	15	5000
		10x12.5	432	0.08	12	5500
	270	8x8	528	0.08	12	4500
		8x11.5	528	0.08	12	5000
		10x12.5	528	0.08	12	5500
	330	8x8	624	0.08	12	4500
		8x11.5	624	0.08	12	5000
		10x12.5	624	0.08	12	5500
	390	8x8	752	0.10	16	4500
		8x11.5	752	0.10	12	5000
10x12.5		752	0.10	12	5500	
470	8x8	896	0.12	16	4500	
	8x11.5	896	0.10	12	5000	
	10x12.5	896	0.10	12	5500	
560	8x8	1088	0.12	14	5000	
	8x11.5	1088	0.10	12	5500	
	10x12.5	1088	0.10	12	5500	
680	10x12.5	1312	0.10	12	5500	
820	10x12.5	1312	0.10	12	5500	
1000	10x12.5	1600	0.10	12	5500	
1200	10x12.5	1920	0.12	12	5500	

Ripple Current(mA,rms)at 105°C,100KHz

Standard Ratings

W.V. (V)	Cap(μF)	Size φ DxL(mm)	L.C. (μA,2min)	tg δ (120Hz,20°C)	ESR (mΩ),100KHz	Maximum Permissible Ripple Current(mA,r.m.s)
20	39	8x8	156	0.08	25	3500
		8x11.5	156	0.08	20	3800
	47	8x8	188	0.08	25	3500
		8x11.5	188	0.08	20	3800
	68	8x8	272	0.08	25	3500
		8x11.5	272	0.08	20	4100
	82	8x8	328	0.08	20	3800
		8x11.5	328	0.08	20	4100
	100	8x8	400	0.08	18	3900
		8x11.5	400	0.08	18	4200
		10x12.5	400	0.08	18	4500
	150	8x8	600	0.08	18	3900
		8x11.5	600	0.08	18	4200
		10x12.5	600	0.08	18	4500
	180	8x8	720	0.08	18	3900
		8x11.5	720	0.08	18	4200
		10x12.5	720	0.08	18	4500
	220	8x8	880	0.08	18	3900
		8x11.5	880	0.08	18	4200
		10x12.5	880	0.08	18	4500
270	8x11.5	1080	0.08	15	4500	
	10x12.5	1080	0.08	15	4900	
330	8x11.5	1320	0.08	15	4500	
	10x12.5	1320	0.08	15	4900	
390	8x11.5	1560	0.08	15	4500	
	10x12.5	1560	0.08	15	4900	
470	10x12.5	1880	0.08	15	4900	
560	10x12.5	2240	0.10	20	4500	
680	10x12.5	2720	0.10	20	4500	
820	10x12.5	3280	0.12	20	4500	
1000	10x12.5	2000	0.12	20	4500	
25	39	8x8	195	0.08	25	3500
		8x11.5	195	0.08	20	3800
	47	8x8	235	0.08	25	3500
		8x11.5	235	0.08	20	3800
	68	8x8	340	0.08	25	3500
		8x11.5	340	0.08	20	4100
	82	8x8	410	0.08	20	3800
		8x11.5	410	0.08	20	4100
	100	8x8	500	0.08	20	3900
		8x11.5	500	0.08	20	4200
		10x12.5	500	0.08	20	4500
	150	8x8	750	0.08	20	3900
		8x11.5	750	0.08	20	4200
		10x12.5	750	0.08	20	4500
	180	8x8	900	0.08	20	3900
		8x11.5	900	0.08	20	4200
		10x12.5	900	0.08	20	4500
	220	8x8	1100	0.08	20	3900
		8x11.5	1100	0.08	20	4200
		10x12.5	1100	0.08	20	4500
270	8x11.5	1350	0.08	18	4400	
	10x12.5	1350	0.08	18	4800	
330	8x11.5	1650	0.08	18	4400	
	10x12.5	1650	0.08	18	4800	
390	10x12.5	1950	0.08	20	4500	
470	10x12.5	2350	0.08	20	4500	
560	10x12.5	2800	0.10	20	4500	
680	10x12.5	3400	0.12	20	4500	
820	10x12.5	2050	0.12	20	4500	

Ripple Current(mA,rms)at 105°C,100KHz

PU series Ultra Low ESR $\leq 7m\Omega$

Features

- ◆ Ultra Low ESR at high frequency range.
- ◆ Ultra Large permissible ripple current.



Conductive Polymer

Specifications

Item	Performance Characteristics	
Operating Temperature Range	-55°C~+105°C	
Rated Voltage Range	2.5~10 VDC	
Capacitance Range	180 to 3500 μ F	
Capacitance Tolerance	$\pm 20\%$ (120Hz,+20°C)	
Leakage Current (+20°C,max.)	Not to exceed the values shown in Standard Ratings (Rated voltage applied, after 2 minutes at 20°C)	
Dissipation Factor (tan δ , at 20°C , 120Hz)	Not to exceed the values shown in Standard Ratings	
ESR (at 100KHz , 20°C)	Not to exceed the values shown in Standard Ratings	
Endurance 105°C , 2000h , at rated voltage	Capacitance Change	Within $\pm 20\%$ of the value before test
	Leakage current	Not to exceed the value specified
	ESR	Not to exceed 150% of the value specified
	Dissipation Factor	Not to exceed 150% of the value specified
Moisture Resistance Stored at 60°C , RH90~95% , 1000h	Capacitance Change	Within $\pm 20\%$ of the value before test
	Leakage current	Not to exceed the value specified
	ESR	Not to exceed 150% of the value specified
	Dissipation Factor	Not to exceed 150% of the value specified

Frequency Coefficient for Ripple Current

Frequency	120Hz \leq freq. < 1KHz	1KHz \leq freq. < 10KHz	10KHz \leq freq. < 100KHz	100KHz \leq freq. < 300KHz
Coefficient	0.05	0.3	0.7	1

Diagram of Dimensions:(unit:mm)

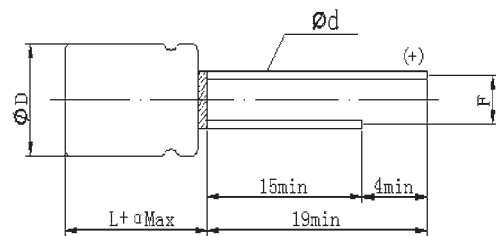

$\phi D \times L$	$\phi D + 0.5$	α	$F \pm 0.5$	$\phi d \pm 0.05$
8x8	8.0	1.0	3.5	0.6
8x11.5	8.0	1.5	3.5	0.6
10x12.5	10.0	1.5	5.0	0.6

Standard Ratings

W.V. (V)	Cap(μF)	Size φ DxL(mm)	L.C. (μA,2min)	tg δ (120Hz,20°C)	ESR (mΩ),100KHz)	Maximum Permissible Ripple Current(mA,r.m.s)
2.5	560	8x8	280	0.08	7	6100
		8x11.5	280	0.08	7	6100
	680	8x8	340	0.08	7	6100
		8x11.5	340	0.08	7	6100
	820	8x8	410	0.08	7	6100
		8x11.5	410	0.08	7	6100
	1000	8x8	500	0.08	7	6100
		8x11.5	500	0.08	7	6100
	1200	8x8	600	0.08	7	6100
		8x11.5	600	0.08	7	6100
	1500	8x8	750	0.08	7	6100
		8x11.5	750	0.08	7	6100
		10x12.5	750	0.08	7	7100
	2000	8x11.5	1000	0.08	7	6100
		10x12.5	1000	0.08	7	7100
	2200	8x11.5	1100	0.08	7	6700
2500	10x12.5	1250	0.08	7	7100	
2700	10x12.5	1350	0.08	7	7100	
3000	10x12.5	1500	0.08	7	7100	
3300	10x12.5	1650	0.08	7	7100	
3500	10x12.5	1750	0.08	7	7100	
3900	10x12.5	1950	0.08	7	7100	
4	560	8x8	224	0.08	7	6100
		8x11.5	224	0.08	7	6100
	680	8x8	272	0.08	7	6100
		8x11.5	272	0.08	7	6100
	820	8x8	328	0.08	7	6100
		8x11.5	328	0.08	7	6100
		10x12.5	328	0.08	7	6600
	1000	8x8	800	0.08	7	6100
		8x11.5	800	0.08	7	6100
		10x12.5	800	0.08	7	6600
	1200	8x11.5	960	0.08	7	6100
		10x12.5	960	0.08	7	6600
	1500	8x11.5	1200	0.10	7	6100
		10x12.5	1200	0.10	7	6600
	1800	10x12.5	1440	0.10	7	6600
	2000	10x12.5	1600	0.10	7	6600
2200	10x12.5	1760	0.10	7	6600	
2500	10x12.5	2000	0.10	7	6600	
2700	10x12.5	2160	0.10	7	6600	

Ripple Current(mA,rms)at 105°C,100KHz

W.V. (V)	Cap(μF)	Size φ DxL(mm)	L.C. (μA,2min)	tg δ (120Hz,20°C)	ESR (mΩ),100KHz)	Maximum Permissible Ripple Current(mA,r.m.s)
6.3	180	8x8	113.4	0.10	7	6100
		8x11.5	113.4	0.10	7	6100
	220	8x8	138.6	0.10	7	6100
		8x11.5	138.6	0.10	7	6100
	270	8x8	170.1	0.10	7	6100
		8x11.5	170.1	0.10	7	6100
	330	8x8	207.9	0.10	7	6100
		8x11.5	207.9	0.10	7	6100
	390	8x8	245.7	0.10	7	6100
		8x11.5	245.7	0.10	7	6100
	470	8x8	296.1	0.10	7	6100
		8x11.5	296.1	0.10	7	6100
	560	8x8	352.8	0.08	7	6100
		8x11.5	352.8	0.08	7	6100
	680	8x8	428.4	0.08	7	6100
		8x11.5	428.4	0.08	7	6600
		10x12.5	428.4	0.08	7	6600
	820	8x8	516.6	0.10	7	6100
		8x11.5	516.6	0.10	7	6600
		10x12.5	516.6	0.10	7	6600
1000	8x8	630	0.10	7	6200	
	8x11.5	630	0.10	7	7100	
	10x12.5	756	0.10	7	7100	
1200	8x11.5	756	0.10	7	7100	
	10x12.5	756	0.10	7	7100	
1500	10x12.5	945	0.10	7	7100	
1800	10x12.5	1134	0.10	7	7100	
2000	10x12.5	1260	0.10	7	7100	
2500	10x12.5	1575	0.10	7	7100	
10	180	8x11.5	180	0.08	7	6600
	220	8x11.5	220	0.08	7	6600
	270	8x11.5	270	0.08	7	6600
	330	8x11.5	330	0.08	7	6600
	390	8x11.5	390	0.08	7	6600
		8x11.5	470	0.08	7	6600
	470	10x12.5	470	0.08	7	6600
		8x11.5	560	0.08	7	6600
	560	10x12.5	560	0.08	7	6600
		8x11.5	680	0.10	7	6600
	680	10x12.5	680	0.10	7	6600
		8x11.5	820	0.10	7	7100
	820	10x12.5	820	0.10	7	7100
		10x12.5	1000	0.10	7	7100
	1200	10x12.5	1200	0.10	7	7100
1500	10x12.5	1500	0.10	7	7100	

Ripple Current(mA,rms)at 105°C,100KHz

PX series Low Profile

Features

- ◆ Low profile
- ◆ Low ESR at high frequency range &.Large permissible ripple current.



Specifications

Item	Performance Characteristics	
Operating Temperature Range	-55°C~+105°C	
Rated Voltage Range	2.5~25 VDC	
Capacitance Range	10 to 820 μ F	
Capacitance Tolerance	±20%(120Hz,+20°C)	
Leakage Current (+20°C,max.)	Not to exceed the values shown in Standard Ratings (Rated voltage applied, after 2 minutes at 20°C)	
Dissipation Factor (tan δ , at 20°C , 120Hz)	Not to exceed the values shown in Standard Ratings	
ESR (at 100KHz , 20°C)	Not to exceed the values shown in Standard Ratings	
Endurance 105°C , 2000h , at rated voltage	Capacitance Change	Within ±20% of the value before test
	Leakage current	Not to exceed the value specified
	ESR	Not to exceed 150% of the value specified
	Dissipation Factor	Not to exceed 150% of the value specified
Moisture Resistance Stored at 60°C , RH90~95% , 1000h	Capacitance Change	Within ±20% of the value before test
	Leakage current	Not to exceed the value specified
	ESR	Not to exceed 150% of the value specified
	Dissipation Factor	Not to exceed 150% of the value specified

Frequency Coefficient for Ripple Current

Frequency	120Hz ≤ freq. < 1KHz	1KHz ≤ freq. < 10KHz	10KHz ≤ freq. < 100KHz	100KHz ≤ freq. < 300KHz
Coefficient	0.05	0.3	0.7	1

Diagram of Dimensions:(unit:mm)

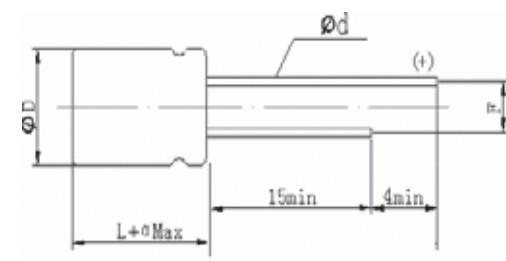

φ DxL	φ D+0.5	α	F±0.5	φ d±0.05
4x5 / 4x7	4.0	1.0	1.5	0.45
4x10	5.0	1.0	1.5	0.50
5x5 / 5x7	5.0	1.0	2.0	0.45
5x8 / 5x9	5.0	1.0	2.0	0.5
5x11	6.3	1.0	2.0	0.6
6.3x5.2 / 6.3x7	6.3	1.0	2.5	0.45
6.3x9	6.3	1.0	2.5	0.5
6.3x11	6.3	1.0	2.5	0.6

Standard Ratings

W.V. (V)	Cap(μF)	Size φ DxL(mm)	L.C. (μA,2min)	tg δ (120Hz,20°C)	ESR (mΩ),100KHz	Maximum Permissible Ripple Current(mA,r.m.s)	
2.5	100	4x5	300	0.08	30	1670	
	150	5x5	300	0.08	30	1970	
		6.3x5.2	300	0.08	30	2200	
	180	5x5	300	0.08	30	1970	
	220	5x5	300	0.08	30	2200	
	330	6.3x5.2	300	0.08	25	2610	
	390	6.3x5.2	300	0.08	20	2690	
		6.3x7	300	0.08	15	3100	
	470	6.3x5.2	300	0.08	20	2690	
		6.3x7	300	0.08	15	3100	
560	5x9	300	0.08	15	3100		
	6.3x7	300	0.08	15	3100		
680	6.3x11	300	0.08	15	3500		
4	100	5x5	300	0.08	30	1970	
		6.3x5.2	300	0.08	30	2200	
	150	6.3x7	300	0.08	25	2670	
	220	6.3x7	300	0.08	20	2690	
	270	6.3x5.2	300	0.08	25	2610	
		6.3x9	300	0.08	15	3300	
	330	6.3x5.2	300	0.08	20	2690	
		6.3x7	300	0.08	15	3100	
	390	6.3x9	300	0.08	15	3300	
	470	6.3x7	300	0.08	15	3100	
560	6.3x11	300	0.08	15	3500		
6.3	82	6.3x5.2	300	0.08	30	2200	
	100	6.3x5.2	300	0.08	25	2390	
		6.3x7	300	0.08	20	2690	
		4x7	300	0.08	35	1900	
	150	5x7	300	0.08	20	2450	
		5x8	300	0.08	15	2690	
		220	6.3x5.2	300	0.08	20	2690
			6.3x7	300	0.08	15	3100
	270	6.3x9	300	0.08	15	3300	
		5x7	300	0.08	20	2450	
		5x8	300	0.08	15	2690	
	330	5x8	300	0.08	15	2690	
		5x9	300	0.08	15	3100	
		6.3x5.2	300	0.08	20	2690	
		6.3x9	300	0.08	15	3300	
	390	5x9	300	0.08	15	3100	
470	6.3x11	300	0.08	15	3500		
	6.3x7	300	0.08	15	3100		
680	6.3x9	300	0.08	15	3300		
	6.3x11	300	0.08	15	3500		
820	6.3x11	300	0.08	15	3500		
10	10	4x5	300	0.08	80	1200	
	22	4x5	300	0.08	80	1200	
	33	5x5	300	0.08	45	1670	
		6.3x5.2	300	0.08	30	2200	
		6.3x7	300	0.08	25	2410	
	39	5x5	300	0.08	45	1670	
	47	6.3x5.2	300	0.08	30	2200	
		6.3x7	300	0.08	20	2690	
		6.3x9	300	0.08	18	3100	
	56	6.3x5.2	300	0.08	30	2200	
68	6.3x9	300	0.08	18	3100		
82	6.3x5.2	300	0.08	30	2200		

Ripple Current(mA,rms)at 105°C,100KHz

W.V. (V)	Cap(μF)	Size φ DxL(mm)	L.C. (μA,2min)	tg δ (120Hz,20°C)	ESR (mΩ),100KHz)	Maximum Permissible Ripple Current(mA,r.m.s)	
10	100	6.3x5.2	300	0.08	30	2200	
		6.3x9	300	0.08	18	3100	
	150	5x7	300	0.08	25	2100	
		6.3x5.2	300	0.08	25	2200	
		6.3x9	300	0.08	18	3100	
	180	5x11	300	0.08	20	2690	
	220	5x11	300	0.08	20	2690	
		6.3x9	300	0.08	15	3300	
	270	5x11	300	0.08	20	2690	
		6.3x7	300	0.08	20	3100	
		6.3x11	300	0.08	15	3500	
	330	6.3x9	300	0.08	15	3300	
470	6.3x9	300	0.08	15	3300		
	6.3x11	300	0.08	15	3500		
16	10	6.3x5.2	300	0.08	30	2200	
	22	6.3x5.2	300	0.08	30	2200	
		6.3x7	300	0.08	25	2610	
	33	6.3x5.2	300	0.08	30	2200	
		6.3x7	300	0.08	25	2610	
	39	6.3x5.2	300	0.08	30	2200	
	47	6.3x5.2	300	0.08	30	2200	
		6.3x7	300	0.08	25	2610	
	82	6.3x7	300	0.08	20	2690	
	100	5x11	300	0.08	20	2690	
		6.3x5.2	300	0.08	30	2200	
		6.3x9	300	0.08	20	2900	
		6.3x11	300	0.08	15	3500	
		150	6.3x7	300	0.08	20	2690
		180	6.3x9	300	0.08	20	3100
	220	6.3x9	300	0.08	20	3100	
		6.3x11	300	0.08	15	3500	
	270	6.3x11	300	0.08	15	3500	
330	6.3x9	300	0.08	15	3100		
20	10	6.3x5.2	300	0.08	30	2200	
	15	6.3x7	300	0.08	25	2670	
	22	6.3x5.2	300	0.08	30	2200	
		6.3x7	300	0.08	25	2670	
	33	6.3x7	300	0.08	25	2670	
		6.3x9	300	0.08	20	2900	
	47	6.3x7	300	0.08	25	2670	
	56	6.3x9	300	0.08	20	2900	
	68	6.3x9	300	0.08	20	2900	
		6.3x11	300	0.08	20	2900	
82	6.3x11	300	0.08	20	2900		
25	6.8	6.3x5.2	300	0.08	40	1800	
	10	6.3x5.2	300	0.08	30	2200	
		6.3x7	300	0.08	25	2670	
	15	6.3x5.2	300	0.08	30	2200	
		6.3x7	300	0.08	25	2670	
	22	6.3x7	300	0.08	25	2670	
	27	6.3x9	300	0.08	25	2670	
	33	6.3x7	300	0.08	25	2670	
		6.3x5.2	300	0.08	30	2200	
	39	6.3x7	300	0.08	25	2670	
47	6.3x9	300	0.08	25	2670		
56	6.3x11	300	0.08	20	2900		
68	6.3x11	300	0.08	20	2900		

Ripple Current(mA,rms)at 105°C,100KHz

PE series

Features

- ◆ Down Size to $\phi 6.3 \times 8$.
- ◆ Low ESR & large capacitance.
- ◆ Large permissible ripple current.



Conductive Polymer

Specifications

Item	Performance Characteristics	
Operating Temperature Range	-55°C~+105°C	
Rated Voltage Range	2.5~16 VDC	
Capacitance Range	270 to 1200 μ F	
Capacitance Tolerance	$\pm 20\%$ (120Hz,+20°C)	
Leakage Current (+20°C,max.)	Not to exceed the values shown in Standard Ratings (Rated voltage applied, after 2 minutes at 20°C)	
Dissipation Factor (tan δ , at 20°C , 120Hz)	Not to exceed the values shown in Standard Ratings	
ESR (100K~300KHz)	Not to exceed the values shown in Standard Ratings	
Endurance 105°C , 2000h , at rated voltage	Capacitance Change	Within $\pm 20\%$ of the value before test
	Leakage current	Not to exceed the value specified
	ESR	Not to exceed 150% of the value specified
	Dissipation Factor	Not to exceed 150% of the value specified
Moisture Resistance Stored at 60°C , RH90~95% , 1000h	Capacitance Change	Within $\pm 20\%$ of the value before test
	Leakage current	Not to exceed the value specified
	ESR	Not to exceed 150% of the value specified
	Dissipation Factor	Not to exceed 150% of the value specified

Frequency Coefficient for Ripple Current

Frequency	120Hz \leq freq.<1KHz	1KHz \leq freq.<10KHz	10KHz \leq freq.<100KHz	100KHz \leq freq.<300KHz
Coefficient	0.05	0.3	0.7	1

Diagram of Dimensions:(unit:mm)

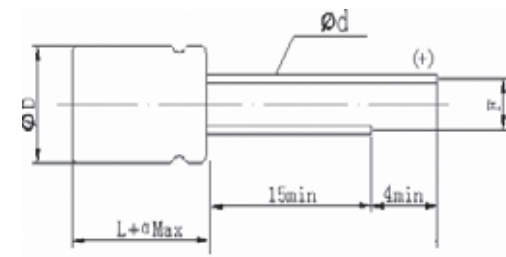

$\phi D \times L$	$\phi D + 0.5$	α	$F \pm 0.5$	$\phi d \pm 0.05$
6.3x8	6.3	1.0	2.5	0.6

Dimensions & Characteristics

W.V. (V)	Capacitance(μ F)	Size $\phi D \times L$ (mm)	L.C. (μ A,2min)	tg δ (120Hz,20°C)	ESR (m Ω),100KHz)	Maximum Permissible Ripple Current (mA,r.m.s)
2.5	560	6.3x8	280	8	7	5600
	820	6.3x8	410	8	7	5600
	1200	6.3x8	600	8	7	5600
4	560	6.3x8	448	8	7	5600
	330	6.3x8	415.2	8	8	5000
6.3	470	6.3x8	592.2	8	7	5600
	560	6.3x8	705.6	8	7	5600
	680	6.3x8	856.8	8	7	5600
16	270	6.3x8	864	8	15	4500

Ripple Current(mA,rms)at 105°C,100KHz

PW series

Features

- ◆ Low height
- ◆ Low ESR at high frequency range.



Specifications

Item	Performance Characteristics	
Operating Temp. Range	-55°C~+105°C	
Rated Voltage Range	2.5~25V DC	
Capacitance Range	39 to 2500 μF	
Capacitance Tolerance	±20% (120Hz , +20°C)	
Leakage Current (+20°C , max)	Not to exceed the values shown in Standard Ratings (Rated voltage applied, after 2 minutes at 20°C)	
Dissipation Factor (tan δ , at 20°C , 120Hz)	Not to exceed the values shown in Standard Ratings	
ESR (at 100KHz , 20°C)	Not to exceed the values shown in Standard Ratings	
Endurance 105°C , 2000h , at rated voltage	Capacitance Change	Within ±20% of the value before test
	Leakage current	Not to exceed the value specified
	ESR	Not to exceed 150% of the value specified
	Dissipation Factor	Not to exceed 150% of the value specified
Moisture Resistance Stored at 60°C , RH90~95% , 1000h	Capacitance Change	Within ±20% of the value before test
	Leakage Current	Not to exceed the value specified
	ESR	Not to exceed 150% of the value specified
	Dissipation Factor	Not to exceed 150% of the value specified

Frequency Coefficient for Ripple Current

Frequency	120Hz ≤ freq. < 1KHz	1KHz ≤ freq. < 10KHz	10KHz ≤ freq. < 100KHz	100KHz ≤ freq. < 300KHz
Coefficient	0.05	0.3	0.7	1

Diagram of Dimensions:(unit:mm)

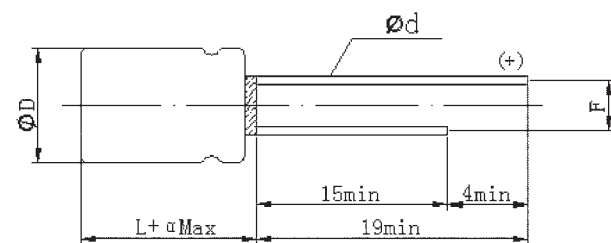

φ DxL	φ D+0.5max.	α	F±0.5	φ d±0.05
8x7	8.0	1.0	3.5	0.6
10x7	10.0	1.5	5.0	0.6
10x10	10.0	1.5	5.0	0.6

Standard Ratings

W.V. (V)	Cap(μF)	Size φ DxL(mm)	L.C. (μA,2min)	tg δ (120Hz,20°C)	ESR (mΩ),100KHz)	Maximum Permissible Ripple Current(mA,r.m.s)
2.5	820	8x7	410	0.08	20	3700
	1000	8x7	500	0.08	20	3700
	1200	10x7	600	0.08	15	4200
	1500	10x7	750	0.10	15	4200
		10x7	900	0.10	15	4200
	1800	10x10	900	0.10	12	4500
		10x7	1000	0.10	15	4200
2000	10x10	1000	0.10	12	4500	
	10x10	1250	0.10	12	4500	
4	560	8x7	448	0.08	20	3700
	680	8x7	544	0.08	20	3700
	820	8x7	656	0.08	20	3700
		10x7	656	0.08	15	4200
	1000	10x7	800	0.10	15	4200
	1200	10x7	960	0.10	15	4200
		10x10	960	0.10	12	4500
	1500	10x7	1200	0.10	15	4200
10x10		1200	0.10	12	4500	
6.3	1800	10x10	1440	0.10	12	4500
	470	8x7	592	0.08	20	3700
	560	8x7	705.6	0.08	20	3700
	680	8x7	856.8	0.08	20	3700
	820	8x7	1033.2	0.10	20	3700
		10x7	1033.2	0.10	15	4200
	1000	10x7	1260	0.10	15	4200
		10x10	1260	0.10	12	4500
1200	10x7	1512	0.10	15	4200	
	10x10	1512	0.10	12	4500	
10	1500	10x10	1890	0.10	12	4500
	330	8x7	660	0.08	20	3700
	390	8x7	780	0.08	20	3700
	470	8x7	940	0.08	20	3700
		10x7	940	0.08	15	4200
	560	10x7	1120	0.08	15	4200
		10x10	1120	0.08	12	4500
	680	10x7	1360	0.10	15	4200
10x10		1360	0.10	12	4500	
16	820	10x7	1640	0.10	15	4200
		10x10	1640	0.10	12	4500
	1000	10x10	2000	0.10	12	4500
	180	8x7	576	0.08	20	3300
220	8x7	704	0.08	20	3300	
270	8x7	864	0.08	20	3300	
	10x7	864	0.08	20	3700	
330	8x7	1056	0.10	20	3300	
	10x7	1056	0.10	20	3700	
	10x10	1056	0.10	15	4200	
	10x7	1248	0.10	20	3700	
390	10x10	1248	0.10	20	4200	
	10x7	1504	0.10	20	3700	
470	10x10	1504	0.10	15	4200	
	10x10	1792	0.10	15	4200	

Ripple Current(mA,rms)at 105°C,100KHz

W.V. (V)	Cap(μF)	Size φ DxL(mm)	L.C. (μA,2min)	tg δ (120Hz,20°C)	ESR (mΩ),100KHz)	Maximum Permissible Ripple Current(mA,r.m.s)
20	56	8x7	224	0.08	25	3000
	68	8x7	272	0.08	25	3000
	82	8x7	328	0.08	25	3000
		10x7	328	0.08	25	3400
	100	8x7	400	0.08	25	3000
		10x7	400	0.08	25	3400
		10x10	400	0.08	20	3800
	150	8x7	600	0.08	25	3000
		10x7	600	0.08	25	3400
		10x10	600	0.08	20	3800
	180	8x7	720	0.08	25	3000
		10x7	720	0.08	25	3400
10x10		720	0.08	20	3800	
220	10x7	880	0.10	25	3400	
	10x10	880	0.10	20	3800	
270	10x7	1080	0.10	25	3400	
	10x10	1080	0.10	20	3800	
330	10x10	1320	0.10	20	3800	
25	39	8x7	195	0.08	25	3000
	47	8x7	235	0.08	25	3000
	56	8x7	280	0.08	25	3000
	68	8x7	340	0.08	25	3000
		10x7	340	0.08	25	3400
	82	8x7	410	0.08	25	3000
		10x7	410	0.08	25	3400
		10x10	410	0.08	20	3800
	100	10x7	500	0.10	25	3400
		10x10	500	0.10	20	3800
	120	10x7	600	0.10	25	3400
		10x10	600	0.10	20	3800
150	10x7	750	0.10	25	3400	
	10x10	750	0.10	20	3800	
180	10x10	900	0.10	20	3800	

Ripple Current(mA,rms)at 105°C,100KHz

PH series High Voltage/High Reliability

Features

- ◆ High voltage and high reliability
- ◆ Large permissible ripple current.
- ◆ Low ESR at high frequency range.



Conductive Polymer

Specifications

Item	Performance Characteristics	
Operating Temp. Range	-55°C~+105°C	
Rated Voltage Range	35 ~100V DC	
Capacitance Range	8.2~220 μ F	
Capacitance Tolerance	±20% (120Hz , +20°C)	
Leakage Current	Not to exceed the values shown in Standard Ratings (Rated voltage applied, after 2 minutes at 20°C)	
Dissipation Factor (tan δ , at 20°C , 120Hz)	Not to exceed the values shown in Standard Ratings	
ESR (at 100KHz , 20°C)	Not to exceed the values shown in Standard Ratings	
Endurance 105°C , 2000h , at rated voltage	Capacitance Change	Within ±20% of the value before test
	Leakage current	Not to exceed the value specified
	ESR	Not to exceed 150% of the value specified
	Dissipation Factor	Not to exceed 150% of the value specified
Moisture Resistance Stored at 60°C , RH90~95% , 1000h	Capacitance Change	Within ±20% of the value before test
	Leakage Current	Not to exceed the value specified
	ESR	Not to exceed 150% of the value specified
	Dissipation Factor	Not to exceed 150% of the value specified

Frequency Coefficient for Ripple Current

Frequency	120Hz ≤ freq. < 1KHz	1KHz ≤ freq. < 10KHz	10KHz ≤ freq. < 100KHz	100KHz ≤ freq. < 300KHz
Coefficient	0.05	0.3	0.7	1

Diagram of Dimensions:(unit:mm)

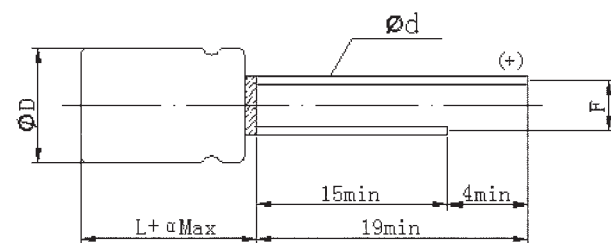

Φ DxL	Φ D+0.5	α	F±0.5	Φ d±0.05
6.3x8	6.3	1.0	2.5	0.6
8x8	8.0	1.0	3.5	0.6
8x9/8x11.5	8.0	1.5	3.5	0.6
10x10	10.0	1.5	5.0	0.6
10x12.5	10.0	1.5	5.0	0.6

Standard Ratings

W.V. (V)	Cap(μF)	Size φDxL(mm)	L.C. (μA,2min)	tg δ (120Hz,20°C)	ESR (mΩ),100KHz)	Maximum Permissible Ripple Current(mA,r.m.s)
35	10	6.3x8	175	0.12	40	2100
		8x8	175	0.12	35	2300
	22	6.3x8	154	0.12	40	2100
		8x11.5	154	0.12	30	2890
	33	8x8	231	0.12	30	2500
		8x11.5	231	0.12	25	3100
	39	8x11.5	273	0.12	25	3100
	47	8x8	329	0.12	30	2700
		8x11.5	329	0.12	20	3600
		10x12.5	329	0.12	20	3800
	56	8x8	392	0.12	30	2700
		8x11.5	392	0.12	20	3600
	68	8x8	476	0.12	30	2700
		8x11.5	476	0.12	20	3600
		10x12.5	476	0.12	20	4000
	82	8x11.5	574	0.12	20	3600
	100	8x8	700	0.12	25	2800
		8x11.5	700	0.12	20	3600
10x10		700	0.12	25	3000	
10x12.5		700	0.12	20	4000	
120	10x12.5	840	0.12	20	4400	
150	10x12.5	1050	0.12	15	4400	
180	10x12.5	1260	0.12	20	4000	
220	10x12.5	1540	0.12	20	4000	
270	10x12.5	1890	0.12	20	4000	
330	10x12.5	2310	0.12	18	4400	
50	10	8x8	100	0.12	45	2100
	12	6.3x8	120	0.12	50	1800
	22	8x8	220	0.12	45	2300
	27	8x11.5	390	0.12	32	2700
	33	8x8	330	0.12	45	2300
		8x11.5	330	0.12	32	2700
		10x12.5	330	0.12	30	3000
	39	8x11.5	390	0.12	32	2700
		10x12.5	390	0.12	30	3000
	47	8x11.5	470	0.12	30	2800
		10x12.5	470	0.12	25	3400
	56	8x11.5	560	0.12	30	2800
		10x10	560	0.12	30	2800
		10x12.5	560	0.12	25	3400
	68	8x9	680	0.12	40	2400
		8x11.5	680	0.12	30	2800
		10x12.5	680	0.12	25	3400
	82	10x12.5	820	0.12	25	3400
100	10x12.5	1000	0.12	25	3400	
120	10x12.5	1200	0.12	25	3400	

Ripple Current(mA,rms)at 105°C,100KHz

W.V. (V)	Cap(μF)	Size φ DxL(mm)	L.C. (μA,2min)	tg δ (120Hz,20°C)	ESR (mΩ),100KHz)	Maximum Permissible Ripple Current(mA,r.m.s)
63	10	8x8	126	0.12	45	1900
		8x11.5	126	0.12	45	2100
	22	8x8	277.2	0.12	45	2100
	27	8x11.5	340	0.12	35	2300
	33	8x11.5	415.8	0.12	35	2500
		10x10	416	0.12	35	2700
	39	8x11.5	491.4	0.12	35	2500
		10x12.5	491.4	0.12	32	2900
	47	8x11.5	592.2	0.12	35	2500
		10x12.5	592.2	0.12	30	3000
56	10x12.5	705.6	0.12	30	3000	
68	10x12.5	856.8	0.12	30	3000	
82	10x12.5	1033.2	0.12	30	3000	
150	10x12.5	1890	0.12	30	3000	
80	10	8x8	160	0.12	45	1900
	12	8x11.5	192	0.12	38	2100
	22	10x12.5	352	0.12	35	2800
	27	10x12.5	432	0.12	35	2800
	33	8x11.5	528	0.12	38	2100
		10x12.5	528	0.12	35	2800
100	6.8	8x8	136	0.12	45	1800
	8.2	8x11.5	164	0.12	45	1800
	10	8x11.5	200	0.12	42	2100
	12	8x11.5	240	0.12	42	2100
		10x12.5	240	0.12	40	2300
	15	8x11.5	300	0.12	42	2100
	18	10x12.5	360	0.12	35	2500
	22	10x12.5	440	0.12	35	2800
	27	10x12.5	540	0.12	35	2800
33	10x12.5	660	0.12	35	2800	

Ripple Current(mA,rms)at 105°C,100KHz

PT series 125°C Guaranteed



Features

- ◆ 125°C Guaranteed.
- ◆ Low ESR at high frequency range.

Specifications

Item	Performance Characteristics	
Operating Temp. Range	-55°C~+125°C	
Rated Voltage Range	2.5~50V DC	
Capacitance Range	22 to 2500 μF	
Capacitance Tolerance	±20% (120Hz , +20°C)	
Leakage Current	Not to exceed the values shown in Standard Ratings (Rated voltage applied, after 2 minutes at 20°C)	
Dissipation Factor (tan δ , at 20°C , 120Hz)	Not to exceed the values shown in Standard Ratings	
ESR (at 100KHz , 20°C)	Not to exceed the values shown in Standard Ratings	
Endurance 125°C , 2000h , at rated voltage	Capacitance Change	Within ±20% of the value before test
	Leakage current	Not to exceed the value specified
	ESR	Not to exceed 150% of the value specified
	Dissipation Factor	Not to exceed 150% of the value specified
Moisture Resistance Stored at 60°C , RH90~95% , 1000h	Capacitance Change	Within ±20% of the value before test
	Leakage Current	Not to exceed the value specified
	ESR	Not to exceed 150% of the value specified
	Dissipation Factor	Not to exceed 150% of the value specified

Frequency Coefficient for Ripple Current

Frequency	120Hz ≤ freq. < 1KHz	1KHz ≤ freq. < 10KHz	10KHz ≤ freq. < 100KHz	100KHz ≤ freq. < 300KHz
Coefficient	0.05	0.3	0.7	1

Diagram of Dimensions:(unit:mm)

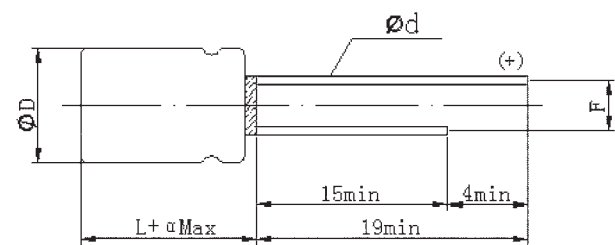

φ DxL	φ D+0.5max.	α	F	φ d±0.05
6.3x5.2	6.3	1	2.5	0.45
6.3x11	6.3	1.5	2.5	0.6
8x7	8.0	1.0	3.5	0.6
8x8	8.0	1.0	3.5	0.6
8x11.5	8.0	1.5	3.5	0.6
10x8	10.0	1.0	5.0	0.6
10x10	10.0	1.5	5.0	0.6
10x12.5	10.0	1.5	5.0	0.6

Standard Ratings

W.V. (V)	Cap(μF)	Size φ DxL(mm)	L.C. (μA,2min)	tg δ (120Hz,20°C)	ESR (mΩ),100KHz)	Rated Ripple Current	
						100KHz (mA,r.m.s)	
						105°C < Tx≤125°C	Tx≤105°C
2.5	820	8x8	410	0.08	9	1741	5500
	1000	8x11.5	500	0.08	9	1929	6100
	1500	8x11.5	750	0.08	9	1929	6100
	2000	10x12.5	1000	0.08	9	2100	6640
	2700	10x12.5	1350	0.08	9	2100	6640
4	150	6.3x5.2	300	0.08	40	572	1810
	330	8x7	264	0.08	30	949	3000
	560	8x8	224	0.08	9	1741	5500
		8x11.5	224	0.08	9	1929	6100
	680	10x8	544	0.08	25	1170	3700
	820	8x8	328	0.08	9	1741	5500
	1200	8x11.5	960	0.08	9	1929	6100
	1500	10x12.5	1200	0.08	9	2100	6640
	2500	10x12.5	2000	0.08	9	2100	6640
	6.3	82	6.3x5.2	258	0.08	40	569
150		8x7	472.5	0.08	30	949	3000
330		10x8	415.8	0.08	25	1170	3700
390		8x8	491.4	0.08	9	1741	5500
470		8x11.5	592	0.08	9	1929	6100
680		8x8	428	0.08	9	1741	5500
		10x12.5	428	0.08	9	1929	6100
820		10x12.5	516.6	0.10	9	1929	6100
1000		8x11.5	630	0.10	9	1929	6100
1500		10x12.5	945	0.10	9	2100	6640
2000	10x12.5	1260	0.10	9	2100	6640	
10	56	6.3x5.2	280	0.08	40	569	1800
	120	8x7	240	0.08	30	949	3000
	220	8x11.5	220	0.08	9	1929	6100
	270	10x8	270	0.08	25	1170	3700
	330	8x11.5	330	0.08	9	1929	6100
	560	10x12.5	560	0.10	9	1929	6100
	680	8x11.5	680	0.10	9	1929	6100
	1000	10x12.5	1000	0.10	9	2100	6640
16	39	6.3x5.2	312	0.08	40	569	1800
	82	8x7	300	0.08	30	854	2700
	100	6.3x11	160	0.08	12	1518	4800
	150	8x8	240	0.08	18	1140	3600
		10x8	240	0.08	25	1044	3300
	180	8x11.5	288	0.08	10	1771	5600
	220	8x11.5	352	0.08	10	1771	5600
	270	8x11.5	432	0.08	10	1771	5600
	330	8x11.5	528	0.08	10	1771	5600
	470	10x12.5	752	0.10	10	1929	6100
560	10x12.5	896	0.10	10	1929	6100	
20	22	6.3x5.2	220	0.12	60	458	1450
	47	8x7	300	0.12	30	854	2700
	68	10x8	272	0.12	30	949	3000
	100	8x11.5	400	0.12	22	1234	3900
	120	8x8	480	0.12	25	981	3100
	150	8x11.5	600	0.12	22	1234	3900
		10x12.5	600	0.12	20	1424	4500
270	10x12.5	1080	0.12	20	1551	4900	

Ripple Current(mA,rms)at 125°C,100KHz

W.V. (V)	Cap(μF)	Size φ DxL(mm)	L.C. (μA,2min)	tg δ (120Hz,20°C)	ESR (mΩ),100KHz)	Rated Ripple Current		Allowable Ripple Current	
						100KHz (mA,r.m.s)			
						105°C < Tx ≤ 125°C	Tx ≤ 105°C	105°C < Tx ≤ 125°C	Tx ≤ 105°C
25	68	8x11.5	340	0.12	24	1108	3500		
	82	8x8	410	0.12	25	981	3100		
	100	10x12.5	500	0.12	20	1424	4500		
	120	8x11.5	600	0.12	22	1234	3900		
	180	10x12.5	900	0.12	20	1424	4500		
35	39	8x8	273	0.12	32	823	2600		
	56	8x11.5	392	0.12	25	1013	3200		
	100	10x12.5	700	0.12	22	1266	4000		
50	22	8x8	220	0.12	35	790	2500		
	27	8x11.5	270	0.12	32	854	2700		
	33	10x10	330	0.12	30	1100	3476		
	47	10x12.5	470	0.12	25	1297	4100		

Ripple Current(mA,rms)at 125°C,100KHz

PF series Long Life to 5,000Hours

Features

- ◆ Super Long Life to 5,000Hours.
- ◆ Low ESR at high frequency range.



Conductive Polymer

Specifications

Item	Performance Characteristics	
Operating Temp. Range	-55°C~+105°C	
Rated Voltage Range	2.5~35V DC	
Capacitance Range	22to 2700 μ F	
Capacitance Tolerance	±20% (120Hz · +20°C)	
Leakage Current	Not to exceed the values shown in Standard Ratings (Rated voltage applied, after 2 minutes at 20°C)	
Dissipation Factor (tan δ , at 20°C · 120Hz)	Not to exceed the values shown in Standard Ratings	
ESR (at 100KHz · 20°C)	Not to exceed the values shown in Standard Ratings	
Endurance 105°C · 5000h · at rated voltage	Capacitance Change	Within ±20% of the value before test
	Leakage current	Not to exceed the value specified
	ESR	Not to exceed 150% of the value specified
	Dissipation Factor	Not to exceed 150% of the value specified
Moisture Resistance Stored at 60°C · RH90~95% · 1000h	Capacitance Change	Within ±20% of the value before test
	Leakage Current	Not to exceed the value specified
	ESR	Not to exceed 150% of the value specified
	Dissipation Factor	Not to exceed 150% of the value specified

Frequency Coefficient for Ripple Current

Frequency	120Hz ≤ freq. < 1KHz	1KHz ≤ freq. < 10KHz	10KHz ≤ freq. < 100KHz	100KHz ≤ freq. < 300KHz
Coefficient	0.05	0.3	0.7	1

Diagram of Dimensions:(unit:mm)

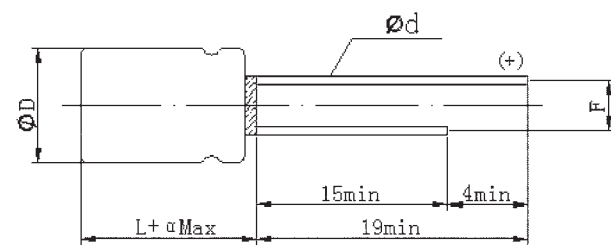

φ DxL	ΦD+0.5max.	α	F	Φd±0.05
4x5	4.0	1.0	1.5	0.45
5x8/5x9	5.0	1.0	2.0	0.5
6.3x5.2	6.3	1.0	2.5	0.5
6.3x8	6.3	1.5	2.5	0.6
6.3x11	6.3	1.5	2.5	0.6
8x7/8x8	8.0	1.0	3.5	0.6
8x11.5	8.0	1.5	3.5	0.6
10x12.5	10.0	1.5	5.0	0.6

Standard Ratings

W.V. (V)	Cap(μF)	Size φ DxL(mm)	L.C. (μA,2min)	tg δ (120Hz,20°C)	ESR (mΩ),100KHz)	Maximum Permissible Ripple Current(mA,r.m.s)
2.5	100	5x8	300	0.08	9	4180
	220	5x8	300	0.08	9	4180
	300	5x9	300	0.08	9	4180
	330	5x8	300	0.08	9	4180
		6.3x8	300	0.08	9	5600
	390	6.3x5.2	300	0.08	15	3100
	470	5x8	300	0.08	9	4180
		6.3x8	300	0.08	9	5600
	560	5x8	300	0.08	9	4180
		6.3x5.2	300	0.08	15	3100
		6.3x8	300	0.08	9	5600
		8x8	300	0.08	9	6100
	820	6.3x8	410	0.08	9	5600
		8x7	410	0.08	10	5000
8x8		410	0.08	9	6100	
1000	8x8	500	0.08	9	6100	
1500	8x11.5	750	0.08	9	6100	
2000	10x12.5	1000	0.08	9	6640	
2700	10x12.5	1350	0.08	9	6640	
4	270	6.3x8	300	0.08	9	5000
	330	5x8	300	0.08	9	4050
	390	6.3x8	312	0.08	9	5000
	560	6.3x8	448	0.08	9	5600
		8x7	448	0.08	15	3900
	680	8x8	542	0.08	9	6100
	820	8x8	656	0.08	9	6100
	1000	8x11.5	800	0.08	9	6100
	1200	10x12.5	960	0.08	9	6640
	1500	10x12.5	1200	0.08	9	6640
2000	10x12.5	1600	0.08	9	6640	
6.3	220	6.3x5.2	300	0.08	18	2980
		6.3x8	300	0.08	10	4500
	270	5x8	340.2	0.08	10	3700
		5x8	415.8	0.08	10	3700
	330	6.3x8	415.8	0.08	9	5000
		8x7	491.4	0.08	15	3900
	390	8x8	491.4	0.08	9	6100
		6.3x8	592.2	0.08	9	5100
	470	8x8	592.2	0.08	9	6100
		6.3x8	705.6	0.08	9	5100
	560	8x8	705.6	0.08	9	6100
		8x8	428	0.08	9	6100
	820	8x8	516.6	0.10	9	6100
		10x12.5	516.6	0.10	9	6640
1000	8x11.5	630	0.10	9	6100	
1200	8x11.5	756	0.10	9	6100	
1500	10x12.5	945	0.10	9	6640	
2000	10x12.5	1260	0.10	9	6640	
10	10	4x5	300	0.08	100	700
	68	6.3x8	300	0.08	10	4500
	100	6.3x8	300	0.08	10	4500
	150	6.3x8	300	0.08	10	4500
	270	8x7	270	0.08	22	3300
8x11.5		270	0.08	9	5600	

Ripple Current(mA,rms)at 105°C,100KHz

W.V. (V)	Cap(μF)	Size φ DxL(mm)	L.C. (μA,2min)	tg δ (120Hz,20°C)	ESR (mΩ),100KHz)	Maximum Permissible Ripple Current(mA,r.m.s)
10	330	8x11.5	330	0.08	9	5600
	390	8x8	390	0.08	9	6100
	470	8x8	470	0.08	9	6100
		10x12.5	470	0.08	9	6100
	560	8x8	560	0.10	9	6100
		10x12.5	560	0.10	9	6100
	680	8x11.5	680	0.10	9	6100
	820	10x12.5	820	0.10	9	6640
1000	10x12.5	1000	0.10	9	6640	
16	100	6.3x5.2	300	0.08	24	2490
		6.3x8	300	0.08	15	3500
		6.3x11	300	0.08	12	4800
	150	6.3x5.2	300	0.08	24	3200
		8x7	300	0.08	22	3300
	180	6.3x11	288	0.08	12	5600
		8x8	288	0.08	10	5100
		10x12.5	288	0.08	10	5600
	220	8x7	352	0.08	22	3300
		8x8	352	0.08	10	5100
	270	8x7	432	0.08	22	3300
		8x8	432	0.08	10	5100
		10x12.5	432	0.08	10	5600
	330	8x8	528	0.10	10	4700
		8x11.5	528	0.08	10	5600
	390	10x12.5	624	0.08	10	6100
	470	8x11.5	752	0.10	10	5400
		10x12.5	752	0.10	10	6100
		8x11.5	896	0.10	10	6100
	560	10x12.5	896	0.10	10	6100
10x12.5		1600	0.10	12	5400	
120	6.3x5.2	480	0.12	25	3200	
150	10x12.5	600	0.12	14	5000	
180	8x7	720	0.12	25	3200	
330	10x12.5	1320	0.12	14	5000	
390	8x11.5	1560	0.12	14	4950	
560	10x12.5	2240	0.12	12	5400	
680	10x12.5	2720	0.12	12	5400	
25	56	6.3x5.2	280	0.12	30	2800
	68	8x11.5	340	0.12	20	4100
	82	6.3x8	410	0.12	28	2780
		8x7	410	0.12	28	3000
	100	8x11.5	500	0.12	20	4100
		10x12.5	500	0.12	18	4650
	180	8x8	900	0.12	18	3770
		8x11.5	900	0.12	18	4200
	220	8x11.5	1100	0.12	18	4200
	270	10x12.5	1350	0.12	18	4650
330	10x12.5	1650	0.12	14	5000	
390	10x12.5	1950	0.12	14	5000	
35	22	6.3x5.2	300	0.12	35	2600
	33	10x12.5	231	0.12	25	3100
	39	8x7	273	0.12	32	2800
	68	8x11.5	476	0.12	20	3600
	82	8x11.5	574	0.12	20	3600
	120	10x12.5	840	0.12	18	4000
150	10x12.5	1050	0.12	18	4000	

Ripple Current(mA,rms)at 105°C,100KHz

PM series SMD type & Low Profile



Features

- ◆ SMD type & Low profile
- ◆ Low ESR at high frequency range & Large permissible ripple current.

Specifications

Item	Performance Characteristics	
Operating Temperature Range	-55°C~+105°C	
Rated Voltage Range	2.5~100V DC	
Capacitance Range	4.7 to 560 μ F	
Capacitance Tolerance	±20% (120Hz · +20°C)	
Leakage Current (+20°C,max.)	Not to exceed the values shown in Standard Ratings (Rated voltage applied, after 2 minutes at 20°C)	
Dissipation Factor (tan δ , at 20°C · 120Hz)	Not to exceed the values shown in Standard Ratings	
ESR (at 100KHz · 20°C)	Not to exceed the values shown in Standard Ratings	
Endurance 105°C · 2000h · at rated voltage	Capacitance Change	Within ±20% of the value before test
	Leakage current	Not to exceed the value specified
	ESR	Not to exceed 150% of the value specified
	Dissipation Factor	Not to exceed 150% of the value specified
Moisture Resistance Stored at 60°C · RH90~95% · 1000h	Capacitance Change	Within ±20% of the value before test
	Leakage current	Not to exceed the value specified
	ESR	Not to exceed 150% of the value specified
	Dissipation Factor	Not to exceed 150% of the value specified

Frequency Coefficient for Ripple Current

Frequency	120Hz ≤ freq. < 1KHz	1KHz ≤ freq. < 10KHz	10KHz ≤ freq. < 100KHz	100KHz ≤ freq. < 300KHz
Coefficient	0.05	0.3	0.7	1

Recommended land pattern:(unit:mm)

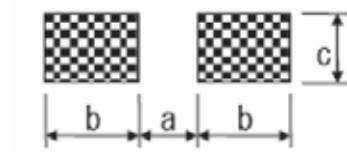

φ DxL	a	b	c
4x5.5	1.0	2.6	1.6
5x5.5	1.4	3.0	1.6
5x5.8	1.4	3.0	1.6
6.3x5.8	2.1	3.5	1.6
6.3x7.7	2.1	3.5	1.6

Diagram of Dimensions:(unit:mm)

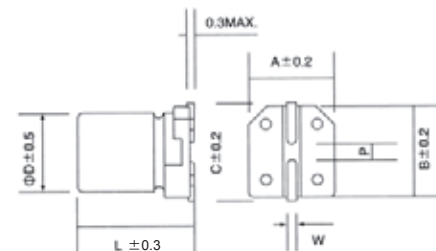

φ DxL	A	B	C	W	P
4x5.5	4.3	4.3	5.1	0.5 to 0.8	1.0
5x5.5	5.3	5.3	5.9	0.5 to 0.8	1.4
5x5.8	5.3	5.3	5.9	0.5 to 0.8	1.4
6.3x5.8	6.5	6.5	7.2	0.5 to 0.8	2.2
6.3x7.7	6.5	6.5	7.2	0.5 to 0.8	2.2

Standard Ratings

W.V. (V)	Cap(μF)	Size φ DxL(mm)	L.C. (μA,2min)	tg δ (120Hz,20°C)	ESR (mΩ),100KHz	Maximum Permissible Ripple Current(mA,r.m.s)
2.5	82	5x5.8	300	0.08	30	2100
	100	6.3x5.8	300	0.08	22	2500
	150	6.3x5.8	300	0.08	22	2500
	180	5x5.8	300	0.08	25	2310
		6.3x5.8	300	0.08	22	2500
	220	5x5.8	300	0.08	25	2310
		6.3x5.8	300	0.08	22	2800
	270	5x5.8	300	0.08	22	2610
		6.3x5.8	300	0.08	22	2800
	330	6.3x5.8	300	0.08	15	3100
		6.3x5.8	300	0.08	25	2610
	390	6.3x5.8	300	0.08	15	3100
		6.3x5.8	300	0.08	20	2800
	470	6.3x5.8	300	0.08	15	3600
6.3x7.7		300	0.08	15	3100	
560	6.3x5.8	300	0.08	15	3600	
	6.3x7.7	300	0.08	15	3600	
4	47	5x5.8	300	0.08	25	2310
	56	5x5.8	300	0.08	25	2310
	68	5x5.8	300	0.08	25	2310
	100	5x5.8	300	0.08	25	2310
		6.3x5.8	300	0.08	22	2500
	120	5x5.8	300	0.08	22	2500
		6.3x5.8	300	0.08	22	2500
	150	5x5.8	300	0.08	22	2500
		6.3x5.8	300	0.08	22	2500
		6.3x7.7	300	0.08	20	3100
	180	6.3x5.8	300	0.08	22	2500
		5x5.8	300	0.08	22	2610
	220	6.3x5.8	300	0.08	22	2800
		6.3x7.7	300	0.08	20	3100
		6.3x5.8	300	0.08	22	2800
	270	6.3x7.7	300	0.08	20	3100
		6.3x5.8	300	0.08	20	2800
	330	6.3x5.8	300	0.08	15	3100
6.3x7.7		300	0.08	15	3600	
6.3x5.8		300	0.08	20	2800	
390	6.3x7.7	300	0.08	15	3600	
	6.3x5.8	300	0.08	15	3600	
470	6.3x7.7	300	0.08	15	3600	
6.3	47	5x5.5	300	0.08	30	2000
	56	5x5.5	300	0.08	30	2000
	68	5x5.5	300	0.08	30	2000
		6.3x5.8	300	0.08	22	2690
	82	5x5.5	300	0.08	30	2000
		6.3x5.8	300	0.08	22	2690
	100	5x5.5	300	0.08	30	2000
		6.3x5.8	300	0.08	25	2310
	120	5x5.8	300	0.08	25	2310
		6.3x5.8	300	0.08	22	2800
	150	5x5.8	300	0.08	22	2610
		6.3x5.8	300	0.08	22	2800
		6.3x7.7	300	0.08	20	3100
	180	5x5.8	300	0.08	22	2610
		6.3x5.8	300	0.08	22	2800
		6.3x7.7	300	0.08	20	3100

Ripple Current(mA,rms)at 105°C,100KHz

W.V. (V)	Cap(μF)	Size φ DxL(mm)	L.C. (μA,2min)	tg δ (120Hz,20°C)	ESR (mΩ),100KHz)	Maximum Permissible Ripple Current(mA,r.m.s)	
6.3	220	6.3x5.8	300	0.08	20	3000	
		6.3x5.8	300	0.08	15	3100	
		6.3x7.7	300	0.08	15	3600	
	270	6.3x5.8	300	0.08	20	3000	
		6.3x7.7	300	0.08	15	3600	
	330	6.3x5.8	300	0.08	20	3100	
		6.3x7.7	300	0.08	15	3600	
		6.3x7.7	300	0.08	10	4200	
	390	6.3x7.7	300	0.08	15	3600	
10	4.7	4x5.5	300	0.08	120	980	
	6.8	4x5.5	300	0.08	120	980	
	10	4x5.5	300	0.08	80	1200	
	15	4x5.5	300	0.08	80	1200	
	22	4x5.5	300	0.08	80	1200	
	33	5x5.5	300	0.08	30	2000	
		6.3x5.8	300	0.08	30	2200	
	39	5x5.5	300	0.08	30	2000	
		6.3x5.8	300	0.08	30	2200	
	47	5x5.5	300	0.08	30	2000	
		6.3x5.8	300	0.08	30	2200	
		6.3x7.7	300	0.08	20	2800	
	56	5x5.5	300	0.08	30	2000	
		6.3x5.8	300	0.08	30	2200	
			6.3x7.7	300	0.08	20	2800
	68	5x5.5	300	0.08	30	2000	
		6.3x5.8	300	0.08	30	2200	
		6.3x7.7	300	0.08	20	2800	
	82	5x5.5	300	0.08	30	2000	
		6.3x5.8	300	0.08	30	2200	
		6.3x7.7	300	0.08	20	2800	
	100	5x5.5	300	0.08	30	2000	
		6.3x5.8	300	0.08	30	2200	
		6.3x7.7	300	0.08	20	2800	
	120	6.3x5.8	300	0.08	25	2610	
	150	6.3x5.8	300	0.08	25	2610	
		6.3x7.7	300	0.08	20	3100	
180	6.3x5.8	300	0.08	25	2610		
	6.3x7.7	300	0.08	20	3100		
220	6.3x5.8	300	0.08	25	2610		
	6.3x7.7	300	0.08	20	3100		
270	6.3x7.7	300	0.08	20	3100		
330	6.3x7.7	300	0.08	20	3100		
16	10	5x5.8	400	0.08	40	2000	
		6.3x5.8	400	0.08	35	2200	
		6.3x7.7	400	0.08	30	2610	
	15	5x5.8	400	0.08	40	2000	
		6.3x5.8	400	0.08	35	2200	
		6.3x7.7	400	0.08	30	2610	
	22	5x5.8	400	0.08	40	2000	
		6.3x5.8	400	0.08	35	2200	
			6.3x7.7	400	0.08	30	2610
	33	5x5.8	400	0.08	40	2000	
		6.3x5.8	400	0.08	35	2200	
		6.3x7.7	400	0.08	30	2610	

Ripple Current(mA,rms)at 105°C,100KHz

W.V. (V)	Cap(μF)	Size φ DxL(mm)	L.C. (μA,2min)	tg δ (120Hz,20°C)	ESR (mΩ),100KHz)	Maximum Permissible Ripple Current(mA,r.m.s)
16	39	5x5.8	400	0.08	40	2000
		6.3x5.8	400	0.08	35	2200
		6.3x7.7	400	0.08	30	2610
	47	5x5.8	400	0.08	40	2000
		6.3x5.8	400	0.08	35	2200
		6.3x7.7	400	0.08	30	2610
	56	5x5.8	400	0.08	40	2000
		6.3x5.8	400	0.08	35	2200
		6.3x7.7	400	0.08	30	2610
	68	6.3x5.8	400	0.08	35	2200
		6.3x7.7	400	0.08	25	2690
	82	6.3x5.8	400	0.08	35	2200
		6.3x7.7	400	0.08	25	2690
	100	6.3x5.8	400	0.08	30	2490
6.3x7.7		400	0.08	25	2690	
150	6.3x7.7	400	0.08	25	2690	
180	6.3x5.8	400	0.12	25	3200	
20	10	5x5.8	600	0.08	40	2000
		6.3x5.8	600	0.08	40	2200
	15	6.3x5.8	600	0.08	35	2200
		6.3x5.8	600	0.08	35	2200
	22	6.3x5.8	600	0.08	35	2200
		6.3x7.7	600	0.08	30	2670
	27	6.3x5.8	600	0.08	35	2200
		6.3x5.8	600	0.08	35	2200
	33	6.3x5.8	600	0.08	35	2200
		6.3x7.7	600	0.08	30	2670
	39	6.3x7.7	600	0.08	30	2670
		6.3x5.8	600	0.08	35	2200
47	6.3x7.7	600	0.08	30	2670	
	6.3x5.8	600	0.08	35	2200	
56	6.3x7.7	600	0.08	30	2670	
	6.3x5.8	600	0.12	25	3200	
120	6.3x5.8	600	0.12	25	3200	
25	6.8	6.3x5.8	600	0.08	40	2000
		6.3x5.8	600	0.08	35	2200
	10	6.3x7.7	600	0.08	35	2670
		6.3x5.8	600	0.08	35	2200
	15	6.3x7.7	600	0.08	30	2670
		6.3x5.8	600	0.08	35	2200
	22	6.3x5.8	600	0.08	35	2200
		6.3x7.7	600	0.08	30	2670
	33	6.3x5.8	600	0.08	35	2200
		6.3x7.7	600	0.08	30	2670
35	18	6.3x5.8	600	0.12	64	900
		6.3x5.8	600	0.12	50	1300
	27	6.3x5.8	600	0.12	50	1530
		6.3x7.7	600	0.12	50	1600
	56	6.3x7.7	600	0.12	35	2100
50	8.2	6.3x5.8	600	0.12	80	800
	12	6.3x5.8	600	0.12	80	800
	15	6.3x5.8	600	0.12	80	800
63	5.6	6.3x5.8	600	0.12	100	700
	8.2	6.3x5.8	600	0.12	100	700
100	4.7	6.3x7.7	600	0.12	100	1060

Ripple Current(mA,rms)at 105°C,100KHz

PD series SMD type & Large capacitance



Features

- ◆ SMD type & Large capacitance
- ◆ Ultra low ESR at high frequency range & Large permissible ripple current.
- ◆ Long life and high reliability(reliability: 0.1% / 1000Hrs).

Specifications

Item	Performance Characteristics	
Operating Temperature Range	-55°C~+105°C	
Rated Voltage Range	2.5~100V DC	
Capacitance Range	10 to 3300 μF	
Capacitance Tolerance	±20% (120Hz · +20°C)	
Leakage Current (+20°C,max.)	Not to exceed the values shown in Standard Ratings (Rated voltage applied, after 2 minutes at 20°C)	
Dissipation Factor (tan δ , at 20°C · 120Hz)	Not to exceed the values shown in Standard Ratings	
ESR (at 100KHz · 20°C)	Not to exceed the values shown in Standard Ratings	
Endurance 105°C · 2000h · at rated voltage	Capacitance Change	Within ±20% of the value before test
	Leakage current	Not to exceed the value specified
	ESR	Not to exceed 150% of the value specified
	Dissipation Factor	Not to exceed 150% of the value specified
Moisture Resistance Stored at 60°C · RH90~95% · 1000h	Capacitance Change	Within ±20% of the value before test
	Leakage current	Not to exceed the value specified
	ESR	Not to exceed 150% of the value specified
	Dissipation Factor	Not to exceed 150% of the value specified

Frequency Coefficient for Ripple Current

Frequency	120Hz ≤ freq. < 1KHz	1KHz ≤ freq. < 10KHz	10KHz ≤ freq. < 100KHz	100KHz ≤ freq. < 300KHz
Coefficient	0.05	0.3	0.7	1

Recommended land pattern:(unit:mm)

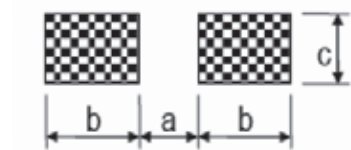

φ DxL	a	b	c
8x11.7	2.8	4.2	1.9
10x12.4	4.3	4.4	1.9

Diagram of Dimensions:(unit:mm)

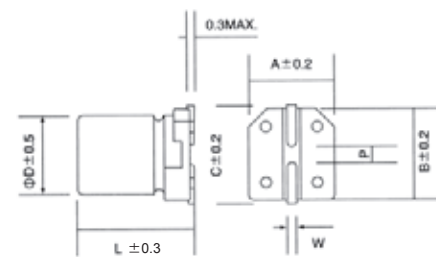

φ DxL	A	B	C	W	P
8x11.7	8.3	8.3	9.0	0.7 to 1.1	3.1
10x12.4	10.3	10.3	11.0	0.7 to 1.1	4.5

Standard Ratings

W.V. (V)	Cap(μF)	Size φDxL(mm)	L.C. (μA,2min)	tg δ (120Hz,20°C)	ESR (mΩ),100KHz)	Maximum Permissible Ripple Current(mA,r.m.s)
2.5	560	8x11.7	280	0.08	9	5200
	680	8x11.7	340	0.08	9	5200
	820	8x11.7	410	0.08	9	5400
	1000	8x11.7	500	0.08	9	5400
	1500	8x11.7	750	0.08	9	5400
		10x12.4	750	0.08	9	5600
	2500	10x12.4	1250	0.08	9	5600
	2700	10x12.4	1350	0.10	9	5600
3300	10x12.4	1650	0.10	9	5600	
4	560	8x11.7	448	0.08	9	5200
	680	8x11.7	544	0.08	9	5200
	820	8x11.7	656	0.08	9	5200
	1000	8x11.7	800	0.10	9	5200
	1200	8x11.7	960	0.10	9	5200
		10x12.4	960	0.10	9	5600
	1500	8x11.7	1200	0.10	9	5200
		10x12.4	1200	0.10	9	5600
	1800	10x12.4	1440	0.10	9	5600
	2200	10x12.4	1760	0.10	9	5600
2500	10x12.4	2000	0.10	9	5600	
2700	10x12.4	2160	0.10	9	5600	
6.3	180	8x11.7	227	0.08	9	5200
	270	8x11.7	340	0.08	9	5200
	330	8x11.7	416	0.08	9	5200
	390	8x11.7	491	0.08	9	5200
	470	8x11.7	592	0.08	9	5200
	560	8x11.7	706	0.08	9	5200
	680	10x12.4	856	0.08	9	5500
	820	8x11.7	1033	0.10	9	5200
		10x12.4	1033	0.10	9	5500
	1000	8x11.7	1260	0.10	9	5200
		10x12.4	1260	0.10	9	5500
	1500	10x12.4	1890	0.10	9	5500
	2000	10x12.4	2520	0.10	9	5500
	2200	10x12.4	2772	0.10	9	5500
10	180	8x11.7	360	0.08	9	5200
	220	8x11.7	440	0.08	9	5200
	270	8x11.7	540	0.08	9	5200
	330	8x11.7	660	0.08	9	5200
	390	8x11.7	780	0.08	9	5200
	470	8x11.7	940	0.08	9	5200
		10x12.4	940	0.08	9	5500
	560	8x11.7	1120	0.08	9	5200
		10x12.4	1120	0.08	9	5500
	680	8x11.7	1360	0.10	9	5200
		10x12.4	1360	0.10	9	5500
	820	10x12.4	1640	0.10	9	5500
	1000	10x12.4	2000	0.10	9	5500
	1200	10x12.4	2400	0.10	9	5500
1500	10x12.4	3000	0.10	9	5500	
16	180	8x11.7	576	0.08	15	4700
	220	8x11.7	704	0.08	15	4700
		10x12.4	704	0.08	15	5100
	270	8x11.7	864	0.08	15	4700
		10x12.4	864	0.08	15	5100
	330	8x11.7	1056	0.08	15	4700
		10x12.4	1056	0.08	15	5100
	390	8x11.7	1248	0.10	15	4700
470	10x12.4	1504	0.10	15	5100	
560	8x11.7	1792	0.12	14	4950	

Ripple Current(mA,rms)at 105°C,100KHz

W.V. (V)	Cap(μF)	Size φ DxL(mm)	L.C. (μA,2min)	tg δ (120Hz,20°C)	ESR (mΩ),100KHz)	Maximum Permissible Ripple Current(mA,r.m.s)
16	680	10x12.4	2176	0.10	15	5100
	820	10x12.4	2624	0.10	15	5100
	1000	10x12.4	3200	0.12	14	5400
20	39	8x11.7	156	0.08	20	4210
	68	8x11.7	272	0.08	20	4210
	82	8x11.7	328	0.08	20	4210
	100	8x11.7	400	0.08	20	4210
		10x12.4	400	0.08	20	4800
	150	10x12.4	600	0.10	20	4800
	180	10x12.4	720	0.10	20	4800
	220	8x11.7	880	0.10	22	4000
		10x12.4	880	0.10	20	4800
	270	8x11.7	1080	0.10	22	4000
		10x12.4	1080	0.10	20	4800
	330	10x12.4	1320	0.10	20	4800
	390	8x11.7	1560	0.12	14	4950
	470	10x12.4	1880	0.12	20	4800
	680	10x12.4	2720	0.12	16	5000
25	33	8x11.7	165	0.08	25	3800
	47	8x11.7	235	0.08	20	4210
	56	10x12.4	280	0.08	28	3800
	82	8x11.7	410	0.08	20	4210
	100	8x11.7	500	0.10	20	4210
		10x12.4	500	0.10	20	4800
	180	8x11.7	900	0.10	25	3800
		10x12.4	900	0.10	20	4800
	220	8x11.7	1100	0.10	25	3800
		10x12.4	1100	0.10	20	4800
	270	10x12.4	1350	0.10	20	4800
	330	8x11.7	1650	0.12	20	4210
		10x12.4	1650	0.12	22	4200
	390	10x12.4	1950	0.12	22	4200
	470	10x12.4	2350	0.12	25	3800
35	39	8x11.7	273	0.12	32	2700
	68	8x11.7	476	0.12	28	3300
	82	8x11.7	574	0.12	28	3300
	100	10x12.4	700	0.12	25	3800
	120	8x11.7	840	0.12	25	3800
	150	8x11.7	1050	0.12	25	3800
		10x12.4	1050	0.12	25	3800
	180	10x12.4	1260	0.12	22	4100
	220	10x12.4	1540	0.12	22	4100
	270	10x12.4	1890	0.12	20	4400
330	10x12.4	2310	0.12	20	4400	
50	10	8x11.7	100	0.12	40	1800
	22	8x11.7	220	0.12	40	1800
	33	8x11.7	330	0.12	35	2000
	39	8x11.7	390	0.12	30	2300
	47	8x11.7	470	0.12	30	2300
	56	8x11.7	560	0.12	30	2500
		10x12.4	560	0.12	25	3000
	68	10x12.4	680	0.12	25	3000
100	10x12.4	1000	0.12	25	3000	
63	22	8x11.7	277	0.12	35	1800
	27	8x11.7	340	0.12	35	2200
	33	8x11.7	416	0.12	35	2200
		10x12.4	416	0.12	30	2500
	39	8x11.7	491	0.12	35	2200
	47	10x12.4	592	0.12	30	2500
	56	10x12.4	706	0.12	30	2500
68	10x12.4	856.8	0.12	30	2500	
80	12	8x11.7	192	0.12	40	1800
	22	10x12.4	352	0.12	38	2300
	47	10x12.4	752	0.12	40	1800
100	10	8x11.7	200	0.12	45	1700
	18	10x12.4	360	0.12	40	2100
	22	10x12.4	440	0.12	40	2100

Ripple Current(mA,rms)at 105°C,100KHz

PV series SMD type & Low height

Features

- ◆ SMD type , Low height & Large capacitance
- ◆ Low ESR at high frequency range &.Large permissible ripple current.
- ◆ Long life and high reliability(reliability: 0.1% / 1000Hrs).



Conductive Polymer

Specifications

Item	Performance Characteristics	
Operating Temperature Range	-55°C~+105°C	
Rated Voltage Range	2.5~100V DC	
Capacitance Range	6.8 to 2500 μF	
Capacitance Tolerance	±20% (120Hz , +20°C)	
Leakage Current (+20°C,max.)	Not to exceed the values shown in Standard Ratings (Rated voltage applied, after 2 minutes at 20°C)	
Dissipation Factor (tan δ , at 20°C , 120Hz)	Not to exceed the values shown in Standard Ratings	
ESR (at 100KHz , 20°C)	Not to exceed the values shown in Standard Ratings	
Endurance 105°C , 2000h , at rated voltage	Capacitance Change	Within ±20% of the value before test
	Leakage current	Not to exceed the value specified
	ESR	Not to exceed 150% of the value specified
	Dissipation Factor	Not to exceed 150% of the value specified
Moisture Resistance Stored at 60°C , RH90~95% , 1000h	Capacitance Change	Within ±20% of the value before test
	Leakage current	Not to exceed the value specified
	ESR	Not to exceed 150% of the value specified
	Dissipation Factor	Not to exceed 150% of the value specified

Frequency Coefficient for Ripple Current

Frequency	120Hz ≤ freq. < 1KHz	1KHz ≤ freq. < 10KHz	10KHz ≤ freq. < 100KHz	100KHz ≤ freq. < 300KHz
Coefficient	0.05	0.3	0.7	1

Recommended land pattern:(unit:mm)

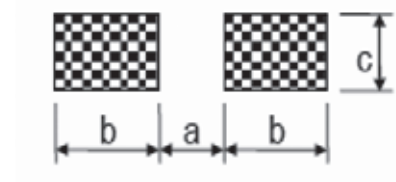

φ DxL	a	b	c
8x7.7	2.8	4.2	1.9
8x8.7	2.8	4.2	1.9
8x10.5	2.8	4.2	1.9
10x8.7	4.3	4.4	1.9
10x10.5	4.3	4.4	1.9

Diagram of Dimensions:(unit:mm)

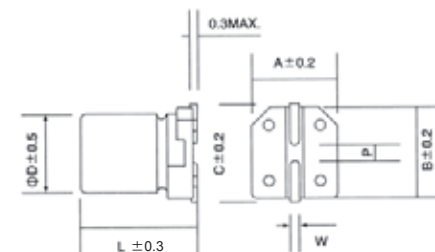

φ DxL	A	B	C	W	P
8x7.7	8.3	8.3	9.0	0.7to1.1	3.1
8x8.7	8.3	8.3	9.0	0.7to1.1	3.1
8x10.5	8.3	8.3	9.0	0.7to1.1	3.1
10x8.7	10.3	10.3	11.0	0.7to1.1	4.5
10x10.5	10.3	10.3	11.0	0.7to1.1	4.5

Standard Ratings

W.V. (V)	Cap(μF)	Size φ DxL(mm)	L.C. (μA,2min)	tg δ (120Hz,20°C)	ESR (mΩ),100KHz)	Maximum Permissible Ripple Current(mA,r.m.s)	
2.5	560	8x7.7	280	0.08	20	3500	
	680	8x7.7	340	0.08	20	3500	
	820	8x7.7	410	0.08	20	3500	
	1000	8x8.7	500	0.08	11	4800	
	1200	10x8.7	600	0.08	20	3700	
	1500	10x8.7	750	0.10	20	3700	
	2200	10x10.5	1100	0.10	11	5500	
	2500	10x10.5	1250	0.10	11	5500	
4	330	8x7.7	264	0.08	20	3500	
	390	8x8.7	312	0.08	15	4200	
	470	8x8.7	376	0.08	15	4200	
	560	8x7.7	448	0.08	20	3500	
		8x8.7	448	0.08	11	4800	
	680	8x7.7	544	0.08	20	3500	
		8x8.7	544	0.08	11	4800	
	820	8x8.7	656	0.08	11	4800	
		10x10.5	656	0.08	11	5100	
	1000	8x10.5	800	0.10	11	5100	
	1200	10x10.5	960	0.10	11	5500	
	1500	10x10.5	1200	0.10	11	5500	
	2000	10x10.5	1600	0.10	11	5500	
	6.3	220	8x7.7	277.2	0.08	20	3500
270		8x7.7	340.2	0.08	20	3500	
330		8x7.7	415.8	0.08	20	3500	
390		8x7.7	491	0.08	20	3500	
470		8x7.7	592.2	0.08	20	3500	
		8x8.7	592	0.08	11	4800	
680		8x8.7	856	0.10	11	4800	
820		10x8.7	1033.2	0.10	20	3700	
1000		10x8.7	1260	0.10	20	3700	
1200		10x10.5	1512	0.10	11	5500	
1500		10x10.5	1890	0.10	11	5500	
10		330	8x7.7	660	0.08	20	3500
		390	8x7.7	780	0.08	20	3500
		470	8x8.7	940	0.08	11	4800
	560	10x8.7	1120	0.08	20	3700	
		10x10.5	1120	0.08	11	4800	
	680	10x8.7	1360	0.10	20	3700	
		10x10.5	1360	0.10	11	4800	
	820	10x10.5	1640	0.10	11	5100	
16	68	8x7.7	217.6	0.08	25	3300	
	150	8x7.7	480	0.08	25	3300	
	180	8x7.7	576	0.08	23	3500	
		8x8.7	576	0.08	16	4800	
	220	8x7.7	704	0.08	23	3500	
		8x8.7	704	0.08	16	4800	
	270	8x8.7	864	0.10	16	4800	
		10x10.5	864	0.10	16	5100	
	330	10x8.7	1056	0.10	23	3700	
		10x10.5	1056	0.10	16	5100	
	390	10x8.7	1248	0.10	23	3700	
		10x10.5	1248	0.10	16	5100	
	470	10x10.5	1504	0.10	16	5100	

Ripple Current(mA,rms)at 105°C,100KHz

W.V. (V)	Cap(μF)	Size φDxL(mm)	L.C. (μA,2min)	tg δ (120Hz,20°C)	ESR (mΩ),100KHz)	Maximum Permissible Ripple Current(mA,r.m.s)
20	27	8x8.7	400	0.10	25	3300
	68	8x8.7	272	0.10	22	3500
	82	8x8.7	328	0.10	22	3500
	100	8x8.7	400	0.10	22	3500
	120	10x8.7	480	0.10	30	2800
	150	8x8.7	600	0.10	22	3500
		10x8.7	600	0.10	27	3100
	180	10x8.7	720	0.10	27	3100
		10x10.5	720	0.10	22	3700
	220	10x8.7	880	0.10	27	3100
10x10.5		880	0.10	22	3700	
270	10x10.5	1080	0.10	22	3700	
330	10x10.5	1320	0.10	22	3700	
25	47	10x8.7	400	0.10	30	2800
	68	8x8.7	340	0.10	22	3500
	82	8x8.7	410	0.10	22	3500
		10x8.7	410	0.10	27	3100
	100	8x8.7	500	0.10	22	3500
		10x8.7	500	0.10	27	3100
	120	8x8.7	600	0.10	22	3500
	150	8x8.7	750	0.10	25	3300
	180	10x10.5	900	0.10	22	3700
270	10x10.5	1350	0.10	25	3500	
35	56	8x7.7	392	0.12	40	2200
	68	8x7.7	476	0.12	35	2400
	82	8x8.7	574	0.12	35	2600
	100	8x8.7	700	0.12	30	3000
		10x10.5	700	0.12	30	3200
	120	10x10.5	840	0.12	30	3200
150	10x10.5	1050	0.12	30	3200	
50	10	8x8.7	100	0.12	45	1500
	33	8x8.7	330	0.12	40	1900
	47	8x10.5	470	0.12	35	2200
		10x10.5	470	0.12	35	2500
68	10x10.5	680	0.12	35	2600	
63	10	8x8.7	126	0.12	45	1500
	22	8x8.7	277	0.12	40	1700
	27	8x8.7	340	0.12	40	1900
	33	8x8.7	416	0.12	40	1900
		10x10.5	416	0.12	35	2200
47	10x10.5	592	0.12	35	2200	
80	10	8x8.7	160	0.12	45	1600
	15	10x10.5	240	0.12	40	1900
100	6.8	8x8.7	136	0.12	48	1500
	12	10x10.5	240	0.12	45	1900
	15	8x8.7	300	0.12	48	1500

Ripple Current(mA,rms)at 105°C,100KHz

PR series SMD type & Long Life to 5,000Hours



Features

- ◆ SMD type .
- ◆ Long Life to 5,000Hours.

Specifications

Item	Performance Characteristics	
Operating Temperature Range	-55°C~+105°C	
Rated Voltage Range	6.3~50V DC	
Capacitance Range	10 to 1500 μF	
Capacitance Tolerance	±20% (120Hz · +20°C)	
Leakage Current (+20°C,max.)	Not to exceed the values shown in Standard Ratings (Rated voltage applied, after 2 minutes at 20°C)	
Dissipation Factor (tan δ , at 20°C · 120Hz)	Not to exceed the values shown in Standard Ratings	
ESR (100K~300KHz)	Not to exceed the values shown in Standard Ratings	
Endurance 105°C · 5000h · at rated voltage	Capacitance Change	Within ±20% of the value before test
	Leakage current	Not to exceed the value specified
	ESR	Not to exceed 150% of the value specified
	Dissipation Factor	Not to exceed 150% of the value specified
Moisture Resistance Stored at 60°C · RH90~95% · 1000h	Capacitance Change	Within ±20% of the value before test
	Leakage current	Not to exceed the value specified
	ESR	Not to exceed 150% of the value specified
	Dissipation Factor	Not to exceed 150% of the value specified

Frequency Coefficient for Ripple Current

Frequency	120Hz ≤ freq. < 1KHz	1KHz ≤ freq. < 10KHz	10KHz ≤ freq. < 100KHz	100KHz ≤ freq. < 300KHz
Coefficient	0.05	0.3	0.7	1

Recommended land pattern:(unit:mm)

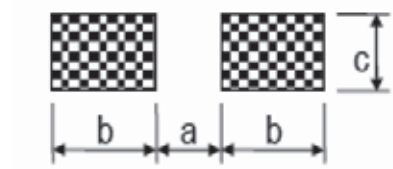

φ DxL	a	b	c
6.3x5.8	2.1	3.5	1.6
6.3x7.7	2.1	3.5	1.6
8x7.7	2.8	4.2	1.9
8x8.7	2.8	4.2	1.9
8x11.7	2.8	4.2	1.9
10x8.7	4.3	4.4	1.9
10x10.5	4.3	4.4	1.9
10x12.4	4.3	4.4	1.9

Diagram of Dimensions:(unit:mm)

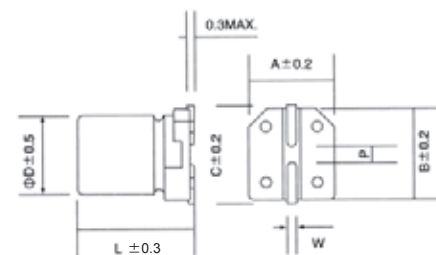

φ DxL	W	H	C	R	P
6.3x5.8	6.5	6.5	7.2	0.5 to 0.8	2.2
6.3x7.7	6.5	6.5	7.2	0.5 to 0.8	2.2
8x7.7	8.3	8.3	9.0	0.7 to 1.1	3.1
8x8.7	8.3	8.3	9.0	0.7 to 1.1	3.1
8x11.7	8.3	8.3	9.0	0.7 to 1.1	3.1
10x8.7	10.3	10.3	11.0	0.7 to 1.1	4.5
10x10.5	10.3	10.3	11.0	0.7 to 1.1	4.5
10x12.4	10.3	10.3	11.0	0.7 to 1.1	4.5

Standard Ratings

W.V. (V)	Cap(μF)	Size φ DxL(mm)	L.C. (μA,2min)	tg δ (120Hz,20°C)	ESR (mΩ),100KHz)	Maximum Permissible Ripple Current(mA,r.m.s)
6.3	100	6.3x5.8	300	0.08	32	2300
	220	6.3x5.8	300	0.08	32	2300
		6.3x5.8	300	0.08	20	2800
	270	6.3x7.7	340.2	0.08	22	3000
	470	8x7.7	592.2	0.08	22	3700
	820	8x11.7	1033.2	0.08	12	5000
	1000	10x10.5	1260	0.08	15	4700
1500	10x12.4	1890	0.08	12	5300	
10	56	6.3x5.8	300	0.08	32	2300
	120	6.3x7.7	300	0.08	22	2900
	150	6.3x7.7	300	0.08	22	2900
	180	6.3x7.7	360	0.08	22	2900
	270	8x7.7	540	0.08	22	3200
	330	10x8.7	660	0.08	22	3700
	470	8x11.7	940	0.08	12	4500
	560	10x10.5	1120	0.08	15	4200
	820	10x12.4	1640	0.08	12	4800
1000	10x12.4	2000	0.08	12	4800	
16	47	6.3x5.8	400	0.10	48	1700
	82	6.3x7.7	400	0.10	28	2400
	100	6.3x7.7	400	0.10	28	2400
	120	6.3x7.7	400	0.12	28	2400
		8x7.7	400	0.12	28	3000
	150	8x8.7	480	0.12	26	3100
		10x8.7	480	0.12	33	3100
	180	8x11.7	576	0.12	18	4200
		10x8.7	576	0.12	33	3100
	220	8x11.7	704	0.12	18	4200
	270	10x10.5	864	0.12	23	3800
	330	10x10.5	1056	0.12	23	3800
	390	10x12.4	1248	0.12	18	4500
560	10x12.4	1792	0.12	18	4500	
680	10x12.4	2176	0.12	18	4500	
20	22	6.3x5.8	600	0.10	48	1700
	33	6.3x5.8	600	0.10	48	1700
	47	6.3x7.7	600	0.10	33	2300
	56	6.3x7.7	600	0.10	33	2300
	68	6.3x7.7	600	0.10	33	2300
	82	8x7.7	600	0.12	33	2900
	120	8x7.7	600	0.12	33	2900
	150	8x11.7	600	0.12	23	4000
	180	8x11.7	720	0.12	23	4000
		10x10.5	720	0.12	25	3650
	220	10x10.5	880	0.12	25	3650
330	10x12.4	1320	0.12	23	4200	

Ripple Current(mA,rms)at 105°C,100KHz

W.V. (V)	Cap(μF)	Size φ DxL(mm)	L.C. (μA,2min)	tg δ (120Hz,20°C)	ESR (mΩ),100KHz)	Maximum Permissible Ripple Current(mA,r.m.s)
25	10	6.3x5.8	600	0.10	58	1600
	22	6.3x5.8	600	0.10	58	1600
	39	6.3x7.7	600	0.10	33	2300
	47	6.3x7.7	600	0.10	33	2300
		8x11.7	600	0.12	23	3700
	56	8x7.7	600	0.12	33	2900
	68	8x7.7	600	0.12	33	2900
		8x11.7	600	0.12	23	4000
	82	8x8.7	600	0.12	27	3200
		8x11.7	600	0.12	23	4000
		10x8.7	600	0.12	33	2900
	100	6.3x7.7	600	0.12	40	2000
		8x8.7	600	0.12	27	3200
	120	8x11.7	600	0.12	23	4000
10x10.5		600	0.12	25	3650	
150	10x12.4	750	0.12	23	4200	
180	10x12.4	900	0.12	23	4200	
220	8x11.7	1100	0.12	23	4000	
	10x12.4	1100	0.12	23	4200	
35	10	6.3x5.8	600	0.12	75	980
	18	6.3x7.7	600	0.12	60	1400
	22	8x11.7	600	0.12	35	2300
	27	6.3x7.7	600	0.12	60	1400
	33	8x11.7	600	0.12	35	2300
	39	8x8.7	600	0.12	40	1800
	56	8x11.7	600	0.12	35	2300
	68	10x10.5	600	0.12	32	2500
	100	10x10.5	700	0.12	32	2500
		10x12.4	700	0.12	30	3100
	150	10x10.5	700	0.12	32	2500
10x12.4		700	0.12	30	3100	
50	10	8x7.7	100	0.12	75	1400
	12	6.3x7.7	120	0.12	75	1400
	22	8x8.7	220	0.12	50	1800
		8x11.7	220	0.12	40	2400
		10x8.7	220	0.12	55	1800
	27	8x11.7	270	0.12	40	2400
	33	10x10.5	330	0.12	42	2200
		10x12.4	330	0.12	30	3000
	47	10x12.4	470	0.12	30	3000
	56	10x12.4	560	0.12	30	3000
68	10x12.4	680	0.12	30	3000	
100	10x12.4	1000	0.12	26	3650	

Ripple Current(mA,rms)at 105°C,100KHz

PG series SMD type & 125°C Guaranteed

Features

- ◆ SMD type .
- ◆ 125°C Guaranteed



Conductive Polymer

Specifications

Item	Performance Characteristics	
Operating Temperature Range	-55°C~+125°C	
Rated Voltage Range	6.3~50V DC	
Capacitance Range	10 to 1500 μF	
Capacitance Tolerance	±20% (120Hz · +20°C)	
Leakage Current (+20°C,max.)	Not to exceed the values shown in Standard Ratings (Rated voltage applied, after 2 minutes at 20°C)	
Dissipation Factor (tan δ , at 20°C · 120Hz)	Not to exceed the values shown in Standard Ratings	
ESR (at 100KHz · 20°C)	Not to exceed the values shown in Standard Ratings	
Endurance 125°C · 2000h · at rated voltage	Capacitance Change	Within ±20% of the value before test
	Leakage current	Not to exceed the value specified
	ESR	Not to exceed 150% of the value specified
	Dissipation Factor	Not to exceed 150% of the value specified
Moisture Resistance Stored at 60°C · RH90~95% · 1000h	Capacitance Change	Within ±20% of the value before test
	Leakage current	Not to exceed the value specified
	ESR	Not to exceed 150% of the value specified
	Dissipation Factor	Not to exceed 150% of the value specified

Frequency Coefficient for Ripple Current

Frequency	120Hz ≤ freq. < 1KHz	1KHz ≤ freq. < 10KHz	10KHz ≤ freq. < 100KHz	100KHz ≤ freq. < 300KHz
Coefficient	0.05	0.3	0.7	1

Recommended land pattern:(unit:mm)

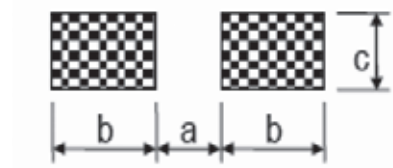

φ DxL	a	b	c
6.3x5.8	2.1	3.5	1.6
6.3x7.7	2.1	3.5	1.6
8x7.7	2.8	4.2	1.9
8x8.7	2.8	4.2	1.9
8x11.7	2.8	4.2	1.9
10x8.7	4.3	4.4	1.9
10x10.5	4.3	4.4	1.9
10x12.4	4.3	4.4	1.9

Diagram of Dimensions:(unit:mm)

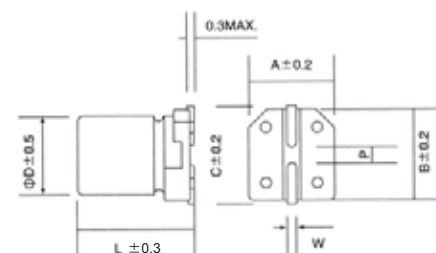

φ DxL	W	H	C	R	P
6.3x5.8	6.5	6.5	7.2	0.5 to 0.8	2.2
6.3x7.7	6.5	6.5	7.2	0.5 to 0.8	2.2
8x7.7	8.3	8.3	9.0	0.7 to 1.1	3.1
8x8.7	8.3	8.3	9.0	0.7 to 1.1	3.1
8x11.7	8.3	8.3	9.0	0.7 to 1.1	3.1
10x8.7	10.3	10.3	11.0	0.7 to 1.1	4.5
10x10.5	10.3	10.3	11.0	0.7 to 1.1	4.5
10x12.4	10.3	10.3	11.0	0.7 to 1.1	4.5

Standard Ratings

W.V. (V)	Cap(μF)	Size φ DxL(mm)	L.C. (μA,2min)	tg δ (120Hz,20°C)	ESR (mΩ),100KHz)	Rated Ripple Current	
						100KHz (mA,r.m.s)	
						105°C < Tx≤125°C	Tx≤105°C
6.3	100	6.3x5.8	300	0.08	35	695	2200
	270	6.3x7.7	340.2	0.08	25	885	2800
	470	8x7.7	592.2	0.08	25	1100	3500
	820	8x11.7	1033.2	0.08	15	1490	4700
	1000	10x10.5	1260	0.08	18	1390	4400
	1500	10x12.4	1890	0.08	15	1610	5100
10	56	6.3x5.8	300	0.08	35	695	2200
	120	6.3x7.7	300	0.08	25	885	2800
	150	6.3x7.7	300	0.08	25	885	2800
	180	6.3x7.7	360	0.08	25	885	2800
	270	8x7.7	540	0.08	25	950	3000
	330	10x8.7	660	0.08	25	1100	3500
	470	8x11.7	940	0.08	15	1330	4200
	560	10x10.5	1120	0.08	18	1265	4000
16	820	10x12.4	1640	0.08	15	1420	4500
	47	6.3x5.8	400	0.10	50	505	1600
	82	6.3x7.7	400	0.10	30	695	2200
	100	6.3x7.7	400	0.10	30	695	2200
	120	8x7.7	400	0.12	30	885	2800
	150	8x8.7	480	0.12	28	950	3000
		10x8.7	480	0.12	35	930	3000
	180	8x11.7	576	0.12	20	1200	3800
		10x8.7	576	0.12	35	930	3000
	220	8x11.7	704	0.12	20	1200	3800
	270	10x10.5	864	0.12	25	1105	3500
	330	10x10.5	1056	0.12	25	1105	3500
390	10x12.4	1248	0.12	20	1265	4000	
560	10x12.4	1792	0.12	20	1265	4000	
20	22	6.3x5.8	600	0.10	50	505	1600
	33	6.3x5.8	600	0.10	50	505	1600
	47	6.3x7.7	600	0.10	35	695	2200
	56	6.3x7.7	600	0.10	35	695	2200
	68	6.3x7.7	600	0.10	35	695	2200
	82	8x7.7	600	0.12	35	885	2800
	120	8x7.7	600	0.12	35	885	2800
	150	8x11.7	600	0.12	25	1200	3800
	180	8x11.7	720	0.12	25	1200	3800
		10x10.5	720	0.12	27	1105	3500
	220	10x10.5	880	0.12	27	1105	3500
	330	10x12.4	1320	0.12	25	1265	4000
25	10	6.3x5.8	600	0.10	60	474	1500
	22	6.3x5.8	600	0.10	60	474	1500
	39	6.3x7.7	600	0.10	35	695	2200
	47	6.3x7.7	600	0.10	35	695	2200
	47	8x11.7	600	0.12	25	1100	3500
	56	8x7.7	600	0.12	35	885	2800
	68	8x7.7	600	0.12	35	885	2800
		8x11.7	600	0.12	25	1200	3800
	82	8x8.7	600	0.12	30	950	3000
		10x8.7	600	0.12	35	885	2800
	100	8x11.7	600	0.12	25	1200	3800
	120	8x11.7	600	0.12	25	1200	3800
		10x10.5	600	0.12	27	1105	3500
	150	10x12.4	750	0.12	25	1265	4000
180	10x12.4	900	0.12	25	1265	4000	

Ripple Current(mA,rms)at 125°C,100KHz

W.V. (V)	Cap(μF)	Size φ DxL(mm)	L.C. (μA,2min)	tg δ (120Hz,20°C)	ESR (mΩ),100KHz	Rated Ripple Current		Allowable Ripple Current	
						100KHz (mA,r.m.s)			
						105°C < Tx ≤ 125°C		Tx ≤ 105°C	
35	10	6.3x5.8	600	0.12	75	310	980		
	18	6.3x7.7	600	0.12	60	450	1400		
	22	8x11.7	600	0.12	35	730	2300		
	27	6.3x7.7	600	0.12	60	450	1400		
	33	8x11.7	600	0.12	35	730	2300		
	39	8x8.7	600	0.12	40	570	1800		
	56	8x11.7	600	0.12	35	730	2300		
	68	10x10.5	600	0.12	32	800	2500		
	100	10x10.5	700	0.12	32	800	2500		
		10x12.4	700	0.12	30	980	3100		
150	8x11.7	1050	0.12	25	1650	4800			
180	10x10.5	1260	0.12	30	1390	4400			
50	10	8x7.7	100	0.12	75	450	1400		
	12	6.3x7.7	120	0.12	75	450	1400		
		8x8.7	220	0.12	50	570	1800		
	22	8x11.7	220	0.12	40	760	2400		
		10x8.7	220	0.12	55	570	1800		
	27	8x11.7	270	0.12	40	760	2400		
	33	10x10.5	330	0.12	42	700	2200		
		10x12.4	330	0.12	30	885	2800		
	47	10x12.4	470	0.12	30	885	2800		
	100	10x12.4	1000	0.12	30	885	2800		
180	10x12.4	1800	0.12	24	950	3000			

Ripple Current(mA,rms)at 125°C,100KHz

AS series Low ESR, Long Life & High Voltage



Features

- ◆ Voltage Range: 16 to 100Vdc, Capacitance Range: 10 to 560 μ F
- ◆ Endurance Range: 105°C 3,000 hours to 10,000 hours
- ◆ RoHS Compliant
- ◆ AEC-Q200 Compliant

Specifications

Items	Performance Characteristics		
Operating Temperature Range	-55°C~+105°C		
Rated Voltage Range	16~100V DC		
Surge Voltage (V)	16	25 35 40 50 63 80 100	
	20	32 44 50 63 79 100 125	
Capacitance Range	10 to 560 μ F		
Capacitance Tolerance	\pm 20% (120Hz , +20°C)		
Leakage Current (+20°C , max)	0.01CV or 3 μ A, whichever is greater		
	(Rated voltage applied, after 2 minutes at 20°C)		
Dissipation Factor (tan δ , at 120Hz , 20°C)	Not to exceed the values shown in Standard Ratings		
ESR (at 100kHz , 20°C)	Not to exceed the values shown in Standard Ratings		
Endurance	105°C rated voltage applied (with the rated ripple current)	Test	
		16V	ϕ 6.3: 3,000hours, D \geq ϕ 8: 7,000hours
		\geq 25V	ϕ 6.3: 5,000hours, D \geq ϕ 8: 10,000hours
		Δ C/C	Within \pm 30% of the initial value
		tan δ	Less than 200% of the specified value
		ESR	Less than 200% of the specified value
LC	Less than the specified value		

Multiplier for Ripple Current vs. Frequency

Frequency	120Hz \leq freq.<1kHz	1KHz \leq freq.<10kHz	10kHz \leq freq.<100kHz	100kHz \leq freq.<300kHz
Coefficient	0.1	0.3	0.6	1.0

Diagram of Dimensions:(unit:mm)

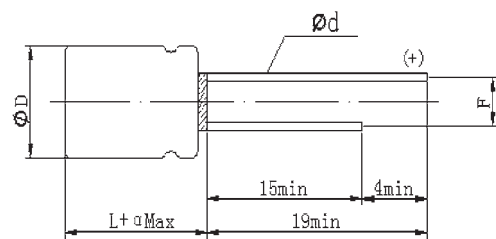

Φ DxL	Φ D+0.5max.	α	F \pm 0.5	Φ d \pm 0.05
6.3x8	6.3	1.0	2.5	0.6
8x9	8.0	1.5	3.5	0.6
10x10	10.0	1.5	5.0	0.6
10x12.5	10.0	1.5	5.0	0.6

Standard Ratings

W.V. (V)	Cap(μF)	Size φ DxL(mm)	L.C. (μA,2min)	tg δ (120Hz,20°C)	ESR (mΩ),100KHz)	Maximum Permissible Ripple Current(mA,r.m.s)
16	120	6.3x8	19.2	0.16	40	1500
	270	8x9	43.2	0.16	26	2000
	470	10x10	75.2	0.16	21	2600
	560	10x12.5	89.6	0.16	15	3000
25	68	6.3x8	17	0.16	45	1400
	150	8x9	37.5	0.16	27	1900
	270	10x10	67.5	0.16	22	2530
	330	10x12.5	82.5	0.16	16	2900
35	47	6.3x8	16.5	0.16	60	1300
	100	8x9	35	0.16	30	1800
	150	10x10	52.5	0.16	23	2470
	220	10x12.5	77	0.16	17	2830
40	27	6.3x8	10.8	0.16	70	1250
	56	8x9	22.4	0.16	32	1750
	100	10x10	40	0.16	24	2400
	120	10x10	48	0.16	18	2750
50	15	6.3x8	7.5	0.16	80	1200
	33	8x9	16.5	0.16	35	1670
	56	10x10	28	0.16	25	2320
	82	10x12.5	41	0.16	19	2650
63	10	6.3x8	6.3	0.16	100	1060
	22	8x9	13.9	0.16	40	1560
	33	10x10	20.8	0.16	30	2100
	47	10x10	29.6	0.16	30	2100
	56	10x12.5	35.3	0.16	22	2400
80	12	10x10	9.6	0.16	70	1600
	15	10x10	12	0.16	70	1600
	18	10x12.5	14.4	0.16	50	1830
100	10	10x10	10	0.16	80	1450
	12	10x10	12	0.16	80	1450
	15	10x12.5	15	0.16	60	1660

Ripple Current(mA,rms)at 105°C,100KHz

AT series 125°C High Reliability , High Ripple Current



Features

- ◆ Voltage Range: 16V to 40Vdc, Capacitance Range: 27 to 560 μ F
- ◆ Endurance Range: 125°C 2,000 hours to 3,000 hours
- ◆ RoHS Compliant
- ◆ AEC-Q200 Compliant

Specifications

Items	Performance Characteristics									
Operating Temperature Range	-55°C~+125°C									
Rated Voltage Range	16~40V DC									
Surge Voltage (V)	<table border="1"> <tr> <td>16</td> <td>25</td> <td>35</td> <td>40</td> </tr> <tr> <td>20</td> <td>32</td> <td>44</td> <td>50</td> </tr> </table>		16	25	35	40	20	32	44	50
16	25	35	40							
20	32	44	50							
Capacitance Range	27 to 560 μ F									
Capacitance Tolerance	±20% (120Hz , +20°C)									
Leakage Current (+20°C , max)	0.01CV or 3 μA, whichever is greater (Rated voltage applied, after 2 minutes at 20°C)									
Dissipation Factor (tan δ , at 120Hz , 20°C)	Not to exceed the values shown in Standard Ratings									
ESR (at 100kHz , 20°C)	Not to exceed the values shown in Standard Ratings									
Endurance	105°C rated voltage applied (with the rated ripple current)	Test								
		16V	φ 6.3: 2,000hours, D≥ φ 8: 2,500hours							
		≥25V	φ 6.3: 2,000hours, D≥ φ 8: 3,000hours							
		ΔC/C	Within ±30% of the initial value							
		tan δ	Less than 200% of the specified value							
		ESR	Less than 200% of the specified value							
LC	Less than the specified value									

Multiplier for Ripple Current vs. Frequency

Frequency	120Hz≤freq.<1kHz	1kHz≤freq.<10kHz	10kHz≤freq.<100kHz	100kHz≤freq.<300kHz
Coefficient	0.1	0.3	0.6	1.0

Diagram of Dimensions:(unit:mm)

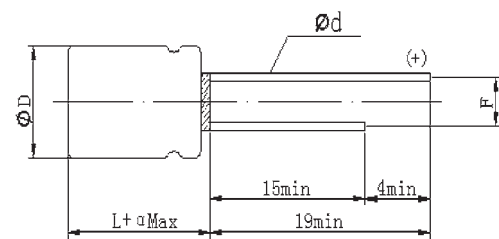

ΦDxL	ΦD+0.5max.	α	F±0.5	Φd±0.05
6.3x8	6.3	1.0	2.5	0.6
8x9	8.0	1.5	3.5	0.6
10x10	10.0	1.5	5.0	0.6
10x12.5	10.0	1.5	5.0	0.6

Standard Ratings

W.V. (V)	Cap(μF)	Size φ DxL(mm)	L.C. (μA,2min)	tg δ (120Hz,20°C)	ESR (mΩ),100KHz)	Maximum Permissible Ripple Current(mA,r.m.s)
16	120	6.3x8	19.2	0.16	32	1440
	270	8x9	43.2	0.16	23	1970
	470	10x10	75.2	0.16	18	2620
	560	10x12.5	89.6	0.16	14	3030
25	68	6.3x8	17	0.16	35	1380
	150	8x9	37.5	0.16	25	1880
	270	10x10	67.5	0.16	19	2500
	330	10x12.5	82.5	0.16	14	2890
35	47	6.3x8	16.5	0.16	45	1280
	100	8x9	35	0.16	28	1780
	150	10x10	52.5	0.16	20	2440
	220	10x12.5	77	0.16	15	2800
40	27	6.3x8	10.8	0.16	48	1230
	56	8x9	22.4	0.16	30	1710
	100	10x10	40	0.16	21	2360
	120	10x12.5	48	0.16	16	2700

Ripple Current(mA,rms)at 125°C,100KHz

AA series SMD type & Long Life to 10000 Hours



Features

- ◆ SMD type
- ◆ Voltage Range: 25 to 80Vdc, Capacitance Range: 10 to 330 μF
- ◆ Endurance : 105°C 10,000 hours
- ◆ RoHS Compliant
- ◆ AEC-Q200 Compliant

Specifications

Items	Performance Characteristics		
Operating Temperature Range	-55°C~+105°C		
Rated Voltage Range	25~80V DC		
Surge Voltage (V)	25	35 50 63 80	
	32	44 63 79 100	
Capacitance Range	10 to 330 μF		
Capacitance Tolerance	±20% (120Hz · +20°C)		
Leakage Current (+20°C · max)	0.01CV or 3 μA, whichever is greater		
	(Rated voltage applied, after 2 minutes at 20°C)		
Dissipation Factor (tan δ · at 120Hz · 20°C)	0.08 to 0.14		
ESR (at 100kHz · 20°C)	Not to exceed the values shown in Standard Ratings		
Endurance	105°C rated voltage applied (with the rated ripple current)	Test	10,000 hours
		ΔC/C	Within ±30% of the initial value
		tan δ	Less than 200% of the specified value
		ESR	Less than 200% of the specified value
		LC	Less than the specified value

Multiplier for Ripple Current vs. Frequency

Frequency	120Hz≤freq.<1kHz	1kHz≤freq.<10kHz	10kHz≤freq.<100kHz	100kHz≤freq.<300kHz
Coefficient	0.1	0.3	0.6	1.0

Recommended land pattern:(unit:mm)

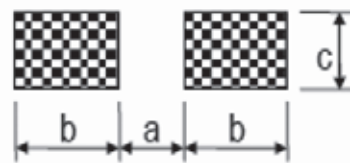

φ DxL	a	b	c
5x5.8	1.4	3.0	1.6
6.3x5.8	2.1	3.5	1.6
6.3x7.7	2.1	3.5	1.6
8x10.5	2.8	4.2	1.9
10x10.5	4.3	4.4	1.9

Diagram of Dimensions:(unit:mm)

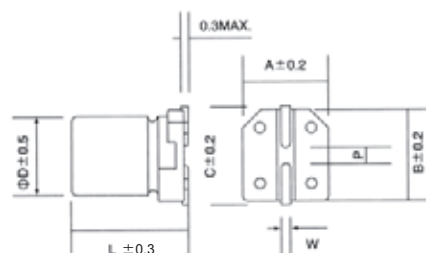

φ DxL	W	H	C	R	P
5x5.8	5.3	5.3	5.9	0.5 to 0.8	1.4
6.3x5.8	6.5	6.5	7.2	0.5 to 0.8	2.2
6.3x7.7	6.5	6.5	7.2	0.5 to 0.8	2.2
8x10.5	8.3	8.3	9.0	0.7 to 1.1	3.1
10x10.5	10.3	10.3	11.0	0.7 to 1.1	4.5

Standard Ratings

W.V. (V)	Cap(μF)	Size φ DxL(mm)	L.C. (μA,2min)	tg δ (120Hz,20°C)	ESR (mΩ),100KHz)	Maximum Permissible Ripple Current(mA,r.m.s)
25	33	5x5.8	8.3	0.14	80	900
	56	6.3x5.8	14	0.14	50	1300
	100	6.3x7.7	25	0.14	30	2000
	220	8x10.5	55	0.14	27	2300
	330	10x10.5	82.5	0.14	20	2500
35	22	5x5.8	7.7	0.12	100	900
	27	6.3x5.8	9.5	0.12	60	1300
	47	6.3x5.8	16.5	0.12	60	1300
	68	6.3x7.7	23.8	0.12	35	2000
	150	8x10.5	52.5	0.12	27	2300
	270	10x10.5	94.5	0.12	20	2500
50	10	5x5.8	5	0.10	120	750
	22	6.3x5.8	11	0.10	80	1100
	33	6.3x7.7	16.5	0.10	40	1600
	68	8x10.5	34	0.10	30	1800
	100	10x10.5	50	0.10	28	2000
63	10	6.3x5.8	6.3	0.08	120	1000
	22	6.3x7.7	13.9	0.08	80	1500
	33	8x10.5	20.8	0.08	40	1700
	56	10x10.5	35.3	0.08	30	1800
80	22	8x10.5	17.6	0.08	45	1550
	33	10x10.5	26.4	0.08	36	1700

Ripple Current(mA,rms)at 105°C,100KHz

AC series SMD type & 125°C Guaranteed



Features

- ◆ SMD type
- ◆ Voltage Range: 25 to 80Vdc, Capacitance Range: 10 to 330 μF
- ◆ Endurance : 125°C 4,000 hours
- ◆ RoHS Compliant
- ◆ AEC-Q200 Compliant

Specifications

Items	Performance Characteristics		
Operating Temperature Range	-55°C~+105°C		
Rated Voltage Range	25~80V DC		
Surge Voltage (V)	25	35 50 63 80	
	32	44 63 79 100	
Capacitance Range	10 to 330 μF		
Capacitance Tolerance	±20% (120Hz · +20°C)		
Leakage Current (+20°C · max)	0.01CV or 3 μA, whichever is greater		
	(Rated voltage applied, after 2 minutes at 20°C)		
Dissipation Factor (tan δ · at 120Hz · 20°C)	0.08 to 0.14		
ESR (at 100kHz · 20°C)	Not to exceed the values shown in Standard Ratings		
Endurance	125°C rated voltage applied (with the rated ripple current)	Test	4,000 hours
		ΔC/C	Within ±30% of the initial value
		tan δ	Less than 200% of the specified value
		ESR	Less than 200% of the specified value
		LC	Less than the specified value

Multiplier for Ripple Current vs. Frequency

Frequency	120Hz≤freq.<1kHz	1kHz≤freq.<10kHz	10kHz≤freq.<100kHz	100kHz≤freq.<300kHz
Coefficient	0.1	0.3	0.6	1.0

Recommended land pattern:(unit:mm)

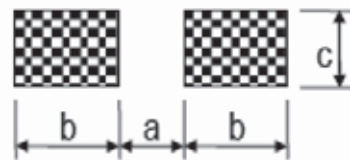

φ DxL	a	b	c
5x5.8	1.4	3.0	1.6
6.3x5.8	2.1	3.5	1.6
6.3x7.7	2.1	3.5	1.6
8x10.5	2.8	4.2	1.9
10x10.5	4.3	4.4	1.9

Diagram of Dimensions:(unit:mm)

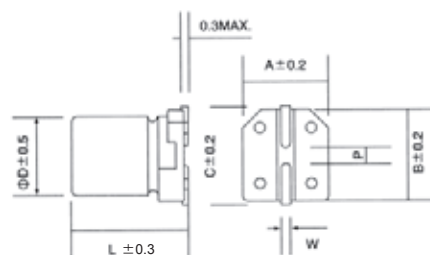

φ DxL	W	H	C	R	P
5x5.8	5.3	5.3	5.9	0.5 to 0.8	1.4
6.3x5.8	6.5	6.5	7.2	0.5 to 0.8	2.2
6.3x7.7	6.5	6.5	7.2	0.5 to 0.8	2.2
8x10.5	8.3	8.3	9.0	0.7 to 1.1	3.1
10x10.5	10.3	10.3	11.0	0.7 to 1.1	4.5

Standard Ratings

W.V. (V)	Cap(μF)	Size φ DxL(mm)	L.C. (μA,2min)	tg δ (120Hz,20°C)	ESR (mΩ),100KHz)	Maximum Permissible Ripple Current(mA,r.m.s)
25	33	5x5.8	8.3	0.14	80	550
	56	6.3x5.8	14	0.14	50	900
	100	6.3x7.7	25	0.14	30	1400
	220	8x10.5	55	0.14	27	1600
	330	10x10.5	82.5	0.14	20	2000
35	22	5x5.8	7.7	0.12	100	550
	47	6.3x5.8	16.5	0.12	60	900
	68	6.3x7.7	23.8	0.12	35	1400
	150	8x10.5	52.5	0.12	27	1600
	270	10x10.5	94.5	0.12	20	2000
50	10	5x5.8	5	0.10	120	500
	22	6.3x5.8	11	0.10	80	750
	33	6.3x7.7	16.5	0.10	40	1100
	68	8x10.5	34	0.10	30	1250
	100	10x10.5	50	0.10	28	1600
	120	10x10.5	60	0.10	28	1600
63	10	6.3x5.8	6.3	0.08	120	700
	22	6.3x7.7	13.9	0.08	80	900
	33	8x10.5	20.8	0.08	40	1100
	56	10x10.5	35.3	0.08	30	1400
	68	10x10.5	42.8	0.08	30	1400
80	22	8x10.5	17.6	0.08	45	1050
	33	10x10.5	26.4	0.08	36	1360
	47	10x10.5	37.6	0.08	36	1360

Ripple Current(mA,rms)at 125°C,100KHz

EV Series

Features

- ◆ Chip type long life capacitance in large case sizes
- ◆ Chip type with Endurance of 1000 hours at +105°C
- ◆ Designed for surface mounting on high density PC board
- ◆ Applicable to automatic insertion machine using carrier tape
- ◆ RoHS Compliant
- ◆ AEC-Q200 qualified



Specifications

Item	Performance Characteristics
Operating Temperature Range	-55~ +105°C
Rated Voltage Range	6.3~50 VDC
Capacitance Range	0.1 to 1500 μF
Capacitance Tolerance	±20%(120Hz,+20°C)
Leakage Current (+20°C,max.)	I ≤ 0.01 CV or 3 (μA) After 2 minutes whichever is greater measured with rated working voltage applied.
Dissipation Factor (tan δ , at 20°C , 120Hz)	Working voltage(VDC)
	D.F.(%)max
Low Temperature Characteristics (at 120Hz)	Impedance ratio max
	Working voltage(VDC)
	Z-25°C / Z+20°C
Endurance	Test condition
	Duration time
	Ambient temperature
	Applied voltage
	After test requirement at +20°C
	Capacitance change
Shelf Life	Test condition
	Duration time
	Ambient temperature
	Applied voltage
	After test requirement at +20°C
	Pre-treatment for measurements shall be conducted after application of DC working voltage for 30 minutes.
Resistance to soldering heat	The capacitors shall be kept on the hot plate maintained at 250°C for 30 seconds. After removing from the hot plate and restored at room temperature, they meet the characteristic requirements listed under.
	Leakage current
	Capacitance change

Multiplier for Ripple Current vs. Frequency

CAP(μF)\Frequency(Hz)	60(50)	120	500	1K	≥10K
0.1 ≤ CAP ≤ 100 μF	0.8	1.0	1.20	1.30	1.50
100 < CAP ≤ 1500 μF	0.8	1.0	1.10	1.15	1.20

φD	L	A	B	C	W	P
4	5.5	4.3	4.3	4.9	0.5~0.8	1.0
5	5.5	5.3	5.3	5.9	0.5~0.8	1.4
6.3	5.5	6.6	6.6	7.2	0.5~0.8	2.2
6.3	6.1	6.6	6.6	7.2	0.5~0.8	2.2
6.3	7.7	6.6	6.6	7.2	0.5~0.8	2.2
8	6.5	8.3	8.3	9.0	0.5~0.8	2.3
8	10.5	8.3	8.3	9.0	0.7~1.1	3.1
10	10.5	10.3	10.3	11.0	0.7~1.1	4.5
12.5	14	13.0	13.0	13.9	1.0~1.4	4.5
16	17	17.0	17.0	18.0	1.0~1.4	6.6
16	21.5	17.0	17.0	18.0	1.0~1.4	6.6
18	16.5	19.0	19.0	20.0	1.0~1.4	6.6
18	21.5	19.0	19.0	20.0	1.0~1.4	6.6

Diagram of Dimensions:(unit:mm)

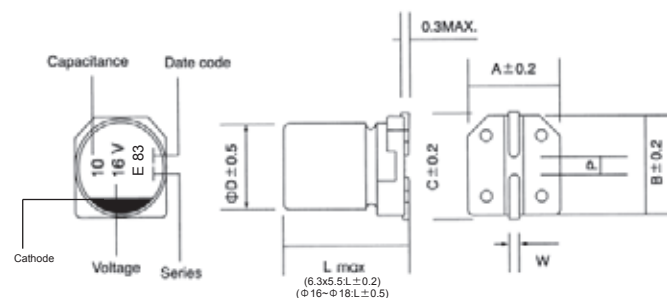

Recommended land pattern:(unit:mm)

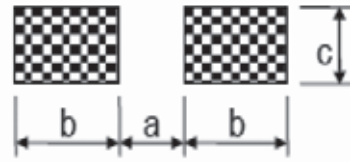

Φ DxL	a	b	c
4xall	1	2.6	1.6
5xall	1.4	3	1.6
6.3xall	2.1	3.5	1.6
8xL(height ≤6.5)	2.1	4.5	1.6
8xL(height >6.5)	2.8	4.2	1.9
10xall	4.3	4.4	1.9
12.5xall	4.3	5.8	2.5
16xall	6	6.5	3.5
18xall	6	7.5	3.5

Case Size

WV (Vdc)	Cap (uF)	Size (mm)	Rated Ripple current (mAmps/105°C /120Hz)
6.3	22	4x5.5	22
6.3	33	4x5.5	30
6.3	47	4x5.5	36
6.3	100	5x5.5	60
6.3	150	6.3x5.5	86
6.3	220	6.3x5.5	89
6.3	220	6.3x7.7	102
6.3	220	8x6.5	102
6.3	330	6.3x7.7	105
6.3	330	8x6.5	105
6.3	470	8x10.5	210
6.3	1000	8x10.5	202
6.3	1000	10x10.5	230
6.3	1500	10x10.5	310
10	22	4x5.5	27
10	33	4x5.5	25
10	33	5x5.5	40
10	47	5x5.5	46
10	100	5x5.5	52
10	100	6.3x5.5	60
10	150	6.3x5.5	86
10	220	6.3x7.7	105
10	220	8x6.5	105
10	330	8x10.5	195
10	470	8x10.5	210
10	1000	10x10.5	310
16	10	4x5.5	18
16	22	4x5.5	30
16	33	5x5.5	40
16	47	5x5.5	51
16	100	6.3x5.5	60
16	150	6.3x7.7	95
16	150	8x6.5	95
16	220	6.3x7.7	105
16	330	8x10.5	195
16	470	8x10.5	210
25	4.7	4x5.5	16
25	10	4x5.5	26
25	22	5x5.5	38
25	33	5x5.5	48
25	47	6.3x5.5	63

WV (Vdc)	Cap (uF)	Size (mm)	Rated Ripple current (mAmps/105°C /120Hz)
25	100	6.3x7.7	91
25	100	8x6.5	91
25	150	8x10.5	140
25	220	8x10.5	155
25	330	8x10.5	175
25	330	10x10.5	198
25	470	10x10.5	300
35	4.7	4x5.5	16
35	10	4x5.5	27
35	22	5x5.5	37
35	22	6.3x5.5	42
35	33	6.3x5.5	50
35	33	6.3x7.7	58
35	47	6.3x5.5	58
35	47	6.3x7.7	66
35	100	6.3x7.7	84
35	100	8x6.5	84
35	150	8x10.5	155
35	220	8x10.5	167
35	220	10x10.5	190
35	330	10x10.5	300
50	0.1	4x5.5	1
50	0.22	4x5.5	2.6
50	0.33	4x5.5	3.2
50	0.47	4x5.5	3.8
50	1	4x5.5	6.3
50	2.2	4x5.5	11
50	3.3	4x5.5	14
50	4.7	4x5.5	19
50	4.7	5x5.5	22
50	10	5x5.5	29
50	10	6.3x5.5	33
50	22	6.3x5.5	51
50	33	6.3x7.7	60
50	33	8x6.5	60
50	47	6.3x7.7	66
50	47	8x6.5	66
50	100	8x10.5	140
50	150	10x10.5	180
50	220	10x10.5	220

LV Series

Features

- ◆ 85°C standard, case diameter $\phi 4 \sim \phi 10\text{mm}$
- ◆ Reflow soldering is available
- ◆ Available for high density mounting
- ◆ RoHS Compliant
- ◆ AEC-Q200 qualified



Specifications

Item	Performance Characteristics	
Operating Temperature Range	-40~ +85°C	
Rated Voltage Range	4~100VDC	160~450VDC
Capacitance Range	0.1 to 6800 μF	3.3 to 68 μF
Capacitance Tolerance	$\pm 20\%$ (120Hz,+20°C)	
Leakage Current (+20°C,max.)	$I \leq 0.01 \text{ CV}$ or $3 (\mu\text{A})$ whichever is greater (2 minutes)	$I \leq 0.04 \text{ CV} + 100 \mu\text{A}$ (1 minute)
Dissipation Factor ($\tan \delta$, at 20°C , 120Hz)	Rated voltage(VDC)	4 6.3 10 16 25 35 50 63 100 160~250 >250
	D.F.(%)max	$\phi 4 \sim 6.3$ 42 30 22 18 16 14 14 12 10 - - $\phi 8 \sim 10$ 45 34 26 20 16 14 14 12 10 15 20 $\geq \phi 12.5$ 45 40 36 24 18 15 14 12 10 15 20
Low Temperature Characteristics (at 120Hz)	Impedance ratio max	
	Rated voltage(VDC)	4 6.3 10 16 25 35 50 63 100 160~250 400 450
	Z-25°C/Z+20°C	7 4 3 2 2 2 2 3 3 3 6 6
Z-40°C/Z+20°C	15 8 8 4 4 3 3 4 4 6 10 15	
Endurance	Test conditions	
	Duration time	:2000 Hrs
	Ambient temperature	:+85°C
	Applied voltage	:Rated DC working voltage
	After test requirement at +20°C:	
	Capacitance change	:Within $\pm 25\%$ of the initial value
	Dissipation factor	:Not more than 200% of specified value
Leakage current	:Not more than the specified value	
Shelf Life	Test conditions	
	Duration time	:1000 Hrs
	Ambient temperature	:+85°C
	Applied voltage	:None
	After test requirement at +20°C	: Same limits as Endurance. Pre-treatment for measurements shall be conducted after application of DC working voltage for 30 minutes.
Resistance to soldering heat	The capacitors shall be kept on the hot plate maintained at 250°C for 30 seconds. After removing from the hot plate and restored at room temperature, they meet the characteristic requirements listed under.	
	Leakage current	Less than specified value
	Capacitance change	Within $\pm 10\%$ of initial value
	$\tan \delta$	Less than specified value

Multiplier for Ripple Current vs. Frequency

CAP(μF) \ Frequency(Hz)	60(50)	120	500	1K	$\geq 10\text{K}$
$0.1 \leq \text{CAP} \leq 100 \mu\text{F}$	0.8	1.0	1.20	1.30	1.50
$100 < \text{CAP}$	0.8	1.0	1.10	1.15	1.20

ϕD	L	A	B	C	W	P
4	5.5	4.3	4.3	4.9	0.5~0.8	1.0
5	5.5	5.3	5.3	5.9	0.5~0.8	1.4
6.3	5.5	6.6	6.6	7.2	0.5~0.8	2.2
6.3	6.1	6.6	6.6	7.2	0.5~0.8	2.2
6.3	7.7	6.6	6.6	7.2	0.5~0.8	2.2
8	6.5	8.3	8.3	9.0	0.5~0.8	2.3
8	10.5	8.3	8.3	9.0	0.7~1.1	3.1
10	10.5	10.3	10.3	11.0	0.7~1.1	4.5
12.5	14	13.0	13.0	13.9	1.0~1.4	4.5
16	17	17.0	17.0	18.0	1.0~1.4	6.6
16	21.5	17.0	17.0	18.0	1.0~1.4	6.6
18	16.5	19.0	19.0	20.0	1.0~1.4	6.6
18	21.5	19.0	19.0	20.0	1.0~1.4	6.6

Diagram of Dimensions:(unit:mm)

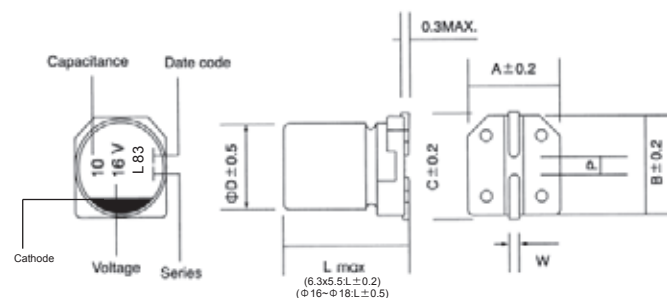

Recommended land pattern:(unit:mm)



Φ DxL	a	b	c
4xall	1	2.6	1.6
5xall	1.4	3	1.6
6.3xall	2.1	3.5	1.6
8xL(height ≤6.5)	2.1	4.5	1.6
8xL(height >6.5)	2.8	4.2	1.9
10xall	4.3	4.4	1.9
12.5xall	4.3	5.8	2.5
16xall	6	6.5	3.5
18xall	6	7.5	3.5

Case Size

WV (Vdc)	Cap (uF)	Size (mm)	Rated Ripple current (mArms/85°C /120Hz)
4	47	4x5.5	28
4	100	5x5.5	34
4	150	6.3x6.1	50
4	220	6.3x5.5	61
4	330	6.3x7.7	135
4	330	8x6.5	145
4	470	8x6.5	180
4	470	8x10.5	220
4	560	8x10.5	242
4	680	8x10.5	285
4	1000	10x10.5	370
4	1200	10x10.5	410
4	1500	10x10.5	470
6.3	22	4x5.5	29
6.3	33	4x5.5	33
6.3	33	5x5.5	37
6.3	47	4x5.5	40
6.3	47	5x5.5	46
6.3	100	5x5.5	70
6.3	100	6.3x6.1	85
6.3	150	6.3x6.1	100
6.3	220	6.3x6.1	130
6.3	220	6.3x7.7	141
6.3	220	8x6.5	150
6.3	330	6.3x7.7	197
6.3	330	8x6.5	210
6.3	470	8x10.5	380
6.3	560	8x10.5	410
6.3	680	8x10.5	460
6.3	1000	8x10.5	480
6.3	1000	10x10.5	500
6.3	1200	10x10.5	510
6.3	1500	10x10.5	530
6.3	3300	12.5x14	750
6.3	6800	16x17	1330
10	10	4x5.5	21
10	22	4x5.5	33
10	22	5x5.5	37
10	33	4x5.5	41
10	33	5x5.5	43
10	47	5x5.5	52
10	100	6.3x5.5	76
10	150	6.3x6.1	88
10	220	6.3x7.7	170
10	220	8x6.5	190
10	330	8x10.5	330
10	470	8x10.5	420
10	560	10x10.5	450
10	680	10x10.5	480

WV (Vdc)	Cap (uF)	Size (mm)	Rated Ripple current (mArms/85°C /120Hz)
10	1000	10x10.5	510
10	2200	12.5x14	730
10	4700	16x17	1200
16	10	4x5.5	23
16	22	4x5.5	37
16	33	5x5.5	45
16	47	5x5.5	50
16	47	6.3x5.5	60
16	100	6.3x5.5	100
16	100	6.3x6.1	108
16	150	6.3x7.7	135
16	220	6.3x7.7	185
16	220	8x10.5	290
16	330	8x10.5	330
16	470	8x10.5	430
16	470	10x10.5	460
16	560	10x10.5	500
16	680	10x10.5	550
16	1000	12.5x14	600
16	1200	12.5x14	660
16	1500	12.5x14	710
16	3300	16x17	1200
25	4.7	4x5.5	18
25	10	4x5.5	27
25	22	5x5.5	40
25	22	6.3x5.5	46
25	33	5x5.5	46
25	33	6.3x5.5	54
25	47	6.3x5.5	60
25	47	6.3x6.1	68
25	100	6.3x7.7	150
25	100	8x6.5	160
25	150	8x10.5	200
25	220	8x10.5	300
25	330	8x10.5	390
25	330	10x10.5	450
25	470	10x10.5	480
25	560	12.5x14	520
25	680	12.5x14	580
25	1000	12.5x14	660
25	2200	16x17	1150
35	4.7	4x5.5	18
35	10	4x5.5	29
35	22	5x5.5	45
35	22	6.3x5.5	48
35	33	6.3x5.5	58
35	47	6.3x5.5	65
35	47	6.3x6.1	70
35	47	8x6.5	115

WV (Vdc)	Cap (uF)	Size (mm)	Rated Ripple current (mArms/85°C /120Hz)
35	100	6.3x7.7	250
35	100	8x10.5	280
35	150	8x10.5	300
35	220	8x10.5	350
35	220	10x10.5	400
35	330	10x10.5	460
35	470	12.5x14	590
35	560	12.5x14	600
35	680	12.5x14	610
35	1500	16x17	1060
50	0.1	4x5.5	1
50	0.22	4x5.5	2
50	0.33	4x5.5	2.8
50	0.47	4x5.5	4
50	1	4x5.5	8.4
50	2.2	4x5.5	14
50	3.3	4x5.5	17
50	4.7	4x5.5	22
50	10	5x5.5	30
50	10	6.3x5.5	35
50	22	6.3x6.1	60
50	22	6.3x7.7	75
50	22	8x6.5	80
50	33	6.3x7.7	188
50	33	8x6.5	200
50	47	6.3x7.7	225
50	47	8x6.5	240
50	100	8x10.5	300
50	150	10x10.5	320
50	220	10x10.5	450
50	330	12.5x14	520
50	470	16x17	925
50	1000	16x17	940
63	0.1	4x5.5	1
63	0.22	4x5.5	2
63	0.33	4x5.5	3
63	0.47	4x5.5	4
63	1	4x5.5	8
63	2.2	4x5.5	14
63	3.3	5x5.5	18
63	4.7	5x5.5	23
63	4.7	6.3x5.5	27
63	10	6.3x5.5	35
63	22	6.3x7.7	75
63	22	8x6.5	75
63	33	8x10.5	160
63	47	8x10.5	170
63	100	10x10.5	270
63	100	12.5x14	340
63	150	12.5x14	380
63	220	12.5x14	460
63	330	16x17	560
63	470	16x17	700
80	1	4x5.5	8
80	2.2	5x5.5	16
80	3.3	6.3x5.5	25
80	4.7	6.3x5.5	30
80	10	6.3x7.7	40
80	22	6.3x7.7	70
80	33	8x10.5	160
80	47	10x10.5	195
80	100	12.5x14	380

WV (Vdc)	Cap (uF)	Size (mm)	Rated Ripple current (mArms/85°C /120Hz)
80	150	12.5x14	450
80	220	16x17	550
100	1	4x5.5	8
100	2.2	6.3x5.5	18
100	2.2	6.3x6.1	20
100	3.3	6.3x5.5	25
100	3.3	6.3x6.1	28
100	4.7	6.3x7.7	38
100	4.7	8x6.5	38
100	10	6.3x7.7	50
100	22	8x10.5	120
100	33	10x10.5	190
100	47	12.5x14	330
100	100	12.5x14	380
100	150	16x17	560
160	10	8x10.5	70
160	12	8x10.5	80
160	18	10x10.5	100
160	22	10x10.5	150
160	27	12.5x14	235
160	33	12.5x14	250
160	39	12.5x14	270
160	47	16x17	400
160	68	16x17	500
200	10	10x10.5	100
200	10	12.5x14	130
200	22	12.5x14	235
200	27	12.5x14	250
200	33	12.5x14	270
200	39	16x17	370
200	47	16x17	420
200	68	16x17	520
250	4.7	8x10.5	70
250	6.8	10x10.5	95
250	10	10x10.5	115
250	15	12.5x14	180
250	22	16x17	280
250	27	16x17	305
250	33	16x17	340
250	39	16x17	370
250	47	16x17	430
400	3.3	10x10.5	50
400	4.7	10x10.5	90
400	4.7	12.5x14	115
400	6.8	12.5x14	130
400	8.2	12.5x14	140
400	10	12.5x14	145
400	10	16x17	160
400	12	16x17	175
400	15	16x17	170
400	18	16x17	195
400	22	16x17	235
450	4.7	12.5x14	115
450	6.8	12.5x14	130
450	8.2	12.5x14	140
450	10	12.5x14	145
450	10	16x17	160
450	12	16x17	175
450	15	16x17	170
450	18	16x17	195
450	22	16x17	235

HV Series

Features

- ◆ Long life of 2000 hrs at 105°C
- ◆ Reflow soldering is available
- ◆ Available for high density mounting
- ◆ RoHS Compliant
- ◆ AEC-Q200 qualified



Specifications

Item	Performance Characteristics													
Operating Temperature Range	-55~ +105°C	-40~ +105°C												
Rated Voltage Range	6.3~100 VDC	160~450 VDC												
Capacitance Range	0.1 to 6800 μF	2.2 to 68 μF												
Capacitance Tolerance	±20%(120Hz,+20°C)													
Leakage Current (+20°C,max.)	I ≤ 0.01 CV or 3 (μA) After 2 minutes, whichever is greater measured with rated working voltage applied													
Dissipation Factor (tan δ , at 20°C , 120Hz)	Rated voltage(VDC)													
	Rated voltage(VDC)	4	6.3	10	16	25	35	50	63	100	160~250	> 250		
	D.F.(%)max	φ 4~6.3	42	30	22	18	16	14	14	12	10	-	-	
		φ 8~10	45	34	26	20	16	14	14	12	10	15	20	
		≥ φ 12.5	45	40	36	24	18	15	14	12	10	15	20	
Low Temperature Characteristics (at 120Hz)	Impedance ratio max													
	Rated voltage(VDC)	4	6.3	10	16	25	35	50	63	100	160~250	400	450	
	Z-25°C/Z+20°C	7	4	3	2	2	2	2	3	3	3	6	6	
		Z-40°C/Z+20°C	15	8	8	4	4	3	3	4	4	6	10	15
Endurance	Test conditions													
	Duration time	:2000 Hrs												
	Ambient temperature	:+105°C												
	Applied voltage	:Rated DC working voltage												
	After test requirement at +20°C:													
	Capacitance change	:Within ±25% of the initial value												
	Dissipation factor	:Not more than 200% of specified value												
Leakage current	:Not more than the specified value													
Shelf Life	Test conditions													
	Duration time	:1000 Hrs												
	Ambient temperature	:+105°C												
	Applied voltage	:None												
	After test requirement at +20°C	: Same limits as Endurance.												
Pre-treatment for measurements shall be conducted after application of DC working voltage for 30 minutes.														
Resistance to soldering heat	The capacitors shall be kept on the hot plate maintained at 250°C for 30 seconds. After removing from the hot plate and restored at room temperature, they meet the characteristic requirements listed under.													
	Leakage current	Less than specified value												
	Capacitance change	Within ±10% of initial value												
	tan δ	Less than specified value												

SMD

Multiplier for Ripple Current vs. Frequency

CAP(μF)\Frequency(Hz)	60(50)	120	500	1K	≥10K
0.1 ≤ CAP ≤ 100 μF	0.8	1.0	1.20	1.30	1.50
100 < CAP	0.8	1.0	1.10	1.15	1.20

φD	L	A	B	C	W	P
4	5.5	4.3	4.3	4.9	0.5~0.8	1.0
5	5.5	5.3	5.3	5.9	0.5~0.8	1.4
6.3	5.5	6.6	6.6	7.2	0.5~0.8	2.2
6.3	6.1	6.6	6.6	7.2	0.5~0.8	2.2
6.3	7.7	6.6	6.6	7.2	0.5~0.8	2.2
8	6.5	8.3	8.3	9.0	0.5~0.8	2.3
8	10.5	8.3	8.3	9.0	0.7~1.1	3.1
10	10.5	10.3	10.3	11.0	0.7~1.1	4.5
12.5	14	13.0	13.0	13.9	1.0~1.4	4.5
16	17	17.0	17.0	18.0	1.0~1.4	6.6
16	21.5	17.0	17.0	18.0	1.0~1.4	6.6
18	16.5	19.0	19.0	20.0	1.0~1.4	6.6
18	21.5	19.0	19.0	20.0	1.0~1.4	6.6

Diagram of Dimensions:(unit:mm)

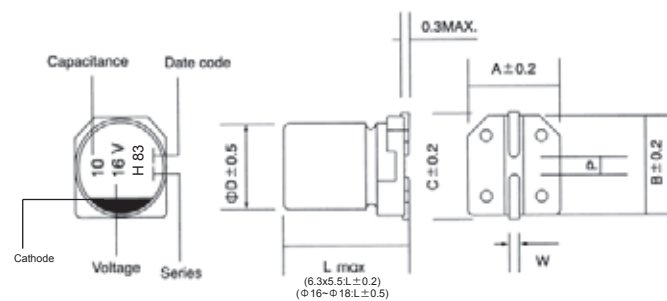

Recommended land pattern:(unit:mm)

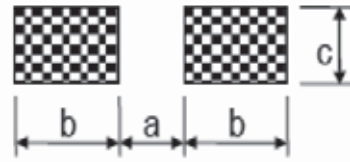

Φ DxL	a	b	c
4xall	1	2.6	1.6
5xall	1.4	3	1.6
6.3xall	2.1	3.5	1.6
8xL(height ≤6.5)	2.1	4.5	1.6
8xL(height >6.5)	2.8	4.2	1.9
10xall	4.3	4.4	1.9
12.5xall	4.3	5.8	2.5
16xall	6	6.5	3.5
18xall	6	7.5	3.5

Case Size

WV (Vdc)	Cap (uF)	Size (mm)	Rated Ripple current (mAmps/105°C /120Hz)
6.3	22	4x5.5	23
6.3	33	4x5.5	28
6.3	47	4x5.5	37
6.3	47	5x5.5	40
6.3	100	5x5.5	46
6.3	100	6.3x5.5	57
6.3	150	6.3x5.5	70
6.3	150	8x6.5	90
6.3	220	6.3x7.7	90
6.3	220	8x6.5	130
6.3	330	6.3x7.7	140
6.3	330	8x10.5	170
6.3	470	8x10.5	210
6.3	560	8x10.5	310
6.3	680	8x10.5	330
6.3	680	10x10.5	370
6.3	1000	8x10.5	420
6.3	1000	10x10.5	480
6.3	1200	10x10.5	500
6.3	1500	10x10.5	520
6.3	1800	12.5x14	600
6.3	2200	12.5x14	650
6.3	3300	12.5x14	700
6.3	6800	16x17	930
10	22	4x5.5	25
10	33	4x5.5	34
10	47	5x5.5	42
10	100	6.3x5.5	55
10	100	8x6.5	60
10	150	6.3x5.5	90
10	150	8x6.5	110
10	220	6.3x7.7	140
10	220	8x6.5	160
10	330	8x10.5	195
10	470	8x10.5	350
10	470	10x10.5	420
10	560	10x10.5	450
10	680	10x10.5	480
10	1000	10x10.5	530
10	1200	12.5x14	570
10	1500	12.5x14	750
10	4700	16x17	880
16	10	4x5.5	20
16	22	4x5.5	31
16	22	5x5.5	35
16	33	5x5.5	36
16	33	6.3x5.5	40
16	47	5x5.5	45
16	47	6.3x5.5	56

WV (Vdc)	Cap (uF)	Size (mm)	Rated Ripple current (mAmps/105°C /120Hz)
16	100	6.3x7.7	58
16	100	8x6.5	62
16	150	6.3x7.7	125
16	150	8x6.5	140
16	220	6.3x7.7	170
16	220	8x10.5	185
16	330	8x10.5	250
16	470	8x10.5	370
16	470	10x10.5	420
16	560	10x10.5	480
16	680	10x10.5	540
16	1000	12.5x14	580
16	1200	12.5x14	590
16	1500	12.5x14	620
16	3300	16x17	850
25	4.7	4x5.5	12
25	10	4x5.5	22
25	22	5x5.5	38
25	33	6.3x5.5	48
25	47	6.3x7.7	56
25	47	8x6.5	60
25	100	6.3x7.7	110
25	100	8x10.5	160
25	150	8x10.5	175
25	220	8x10.5	180
25	220	10x10.5	190
25	330	8x10.5	290
25	470	10x10.5	440
25	560	12.5x14	490
25	680	12.5x14	510
25	1000	12.5x14	600
25	2200	16x17	805
35	4.7	4x5.5	14
35	10	4x5.5	24
35	22	5x5.5	40
35	22	6.3x5.5	46
35	33	6.3x7.7	47
35	33	8x6.5	50
35	47	6.3x7.7	60
35	47	8x6.5	65
35	100	6.3x7.7	130
35	100	8x10.5	180
35	150	8x10.5	190
35	220	8x10.5	250
35	220	10x10.5	280
35	330	10x10.5	360
35	470	12.5x14	460
35	560	12.5x14	500
35	1500	16x17	740

WV (Vdc)	Cap (uF)	Size (mm)	Rated Ripple current (mAmps/105°C /120Hz)
50	0.1	4x5.5	1
50	0.22	4x5.5	2
50	0.33	4x5.5	3
50	0.47	4x5.5	4
50	1	4x5.5	8
50	2.2	4x5.5	11
50	3.3	4x5.5	13
50	4.7	4x5.5	18
50	10	6.3x5.5	28
50	22	6.3x7.7	50
50	22	8x6.5	55
50	33	6.3x7.7	95
50	33	8x10.5	135
50	47	6.3x7.7	115
50	47	8x10.5	155
50	100	10x10.5	315
50	150	10x10.5	330
50	220	10x10.5	350
50	330	12.5x14	400
50	470	16x17	570
50	1000	16x17	655
63	0.1	4x5.5	0.7
63	0.22	4x5.5	1.6
63	0.33	4x5.5	2.5
63	0.47	4x5.5	3.5
63	1	4x5.5	7
63	2.2	4x5.5	11
63	3.3	5x5.5	14
63	4.7	5x5.5	22
63	10	6.3x5.5	40
63	22	6.3x7.7	58
63	33	8x10.5	112
63	47	8x10.5	119
63	100	10x10.5	280
63	220	12.5x14	300
63	470	16x17	630
80	1	4x5.5	7
80	2.2	5x5.5	12
80	3.3	6.3x5.5	17
80	4.7	6.3x5.5	25
80	10	6.3x7.7	35
80	22	6.3x7.7	58
80	33	8x10.5	112
80	47	10x10.5	160
80	100	12.5x14	380
80	150	16x17	500
80	220	16x17	600
100	1	4x5.5	7
100	2.2	6.3x6.1	15
100	2.2	6.3x5.5	13
100	3.3	6.3x6.1	20
100	4.7	6.3x7.7	28

WV (Vdc)	Cap (uF)	Size (mm)	Rated Ripple current (mAmps/105°C /120Hz)
100	10	6.3x7.7	35
100	22	8x10.5	85
100	33	10x10.5	135
100	47	12.5x14	240
100	150	16x17	500
160	10	8x10.5	57
160	12	8x10.5	60
160	18	10x10.5	65
160	22	10x10.5	70
160	27	12.5x14	85
160	33	12.5x14	95
160	39	12.5x14	105
160	47	16x17	260
160	68	16x17	300
200	10	10x10.5	64
200	10	12.5x14	80
200	22	12.5x14	105
200	27	12.5x14	115
200	33	12.5x14	170
200	33	16x17	220
200	47	16x17	260
250	4.7	8x10.5	50
250	6.8	10x10.5	60
250	10	10x10.5	75
250	15	12.5x14	120
250	22	16x17	180
250	27	16x17	200
250	33	16x17	230
250	39	16x17	260
250	47	16x17	285
400	2.2	8x10.5	27
400	3.3	8x10.5	34
400	3.9	10x10.5	40
400	4.7	10x10.5	40
400	4.7	12.5x14	50
400	6.8	12.5x14	60
400	8.2	12.5x14	65
400	10	12.5x14	70
400	10	16x17	85
400	12	16x17	95
400	22	16x17	120
450	3.3	10x10.5	40
450	3.9	10x10.5	40
450	4.7	12.5x14	50
450	6.8	12.5x14	60
450	8.2	12.5x14	65
450	10	12.5x14	70
450	10	16x17	85
450	12	16x17	95
450	15	16x17	100
450	22	16x17	120

JV Series Long Life, High CV



Features

- ◆ Chip type long life capacitance in large case sizes
- ◆ Chip type with Endurance of 3000 hours at +105°C
- ◆ Designed for surface mounting on high density PC board
- ◆ Applicable to automatic insertion machine using carrier tape
- ◆ RoHS Compliant

Specifications

Item	Performance Characteristics
Operating Temperature Range	-55~+105°C
Rated Voltage Range	6.3~50 VDC
Capacitance Range	0.1 to 1000 μF
Capacitance Tolerance	±20%(120Hz,+20°C)
Leakage Current (+20°C,max.)	I ≤ 0.01 CV or 3 (μA) After 2 minutes whichever is greater measured with rated working voltage applied.
Dissipation Factor (tan δ , at 20°C , 120Hz)	Working Voltage(VDC) 6.3 10 16 25 35 50
	D.F.(%)max. 28 24 20 16 13 12
Low Temperature Characteristics (at 120Hz)	Impedance ratio max (at: 120Hz)
	Working voltage(VDC) 6.3 10 16 25 35 50
	Z-25°C / Z+20°C 4 3 2 2 2 2
	Z-40°C / Z+20°C 10 7 5 3 3 3
Endurance	Test condition Duration time : 3000 Hrs Ambient temperature : +105°C Applied voltage : Rated DC working voltage
	After test requirement at +20°C Capacitance change : Within ±30% of initial value Dissipation factor : Less than 300% of specified value Leakage current : Less than specified value
Shelf Life	Test condition Duration time : 1000 Hrs Ambient temperature : +105°C Applied voltage : None
	After test requirement at +20°C: Same limits as Endurance. Pre-treatment for measurements shall be conducted after application of DC working voltage for 30 minutes.
Resistance to soldering heat	The following specifications shall be satisfied when the capacitors are restored to 20°C after exposing them at 250°C for 30 seconds.
	Leakage current Less than specified value
	Capacitance change Within ±10% of initial value
	tan δ Less than specified value

Multiplier for Ripple Current vs. Frequency

CAP(μF)\Frequency(Hz)	60(50)	120	500	1K	≥10K
0.1 ≤ CAP ≤ 100 μF	0.8	1.0	1.20	1.30	1.50
100 < CAP ≤ 1000 μF	0.8	1.0	1.10	1.15	1.20

φD	L	A	B	C	W	P
4	5.5	4.3	4.3	4.9	0.5~0.8	1.0
5	5.5	5.3	5.3	5.9	0.5~0.8	1.4
6.3	5.5	6.6	6.6	7.2	0.5~0.8	2.2
6.3	6.1	6.6	6.6	7.2	0.5~0.8	2.2
6.3	7.7	6.6	6.6	7.2	0.5~0.8	2.2
8	6.5	8.3	8.3	9.0	0.5~0.8	2.3
8	10.5	8.3	8.3	9.0	0.7~1.1	3.1
10	10.5	10.3	10.3	11.0	0.7~1.1	4.5
12.5	14	13.0	13.0	13.9	1.0~1.4	4.5
16	17	17.0	17.0	18.0	1.0~1.4	6.6
16	21.5	17.0	17.0	18.0	1.0~1.4	6.6
18	16.5	19.0	19.0	20.0	1.0~1.4	6.6
18	21.5	19.0	19.0	20.0	1.0~1.4	6.6

Diagram of Dimensions:(unit:mm)

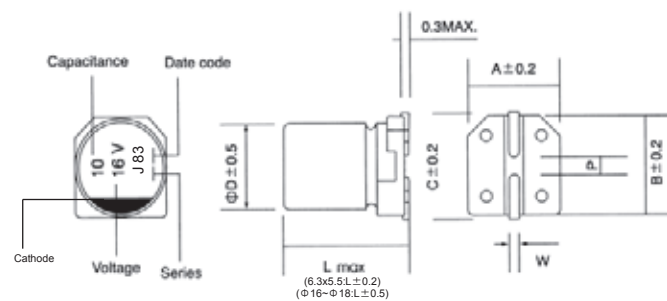

Recommended land pattern:(unit:mm)

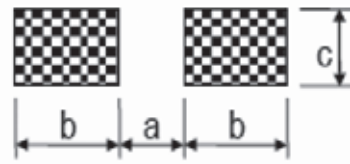

Φ DxL	a	b	c
4xall	1	2.6	1.6
5xall	1.4	3	1.6
6.3xall	2.1	3.5	1.6
8xL(height ≤6.5)	2.1	4.5	1.6
8xL(height >6.5)	2.8	4.2	1.9
10xall	4.3	4.4	1.9
12.5xall	4.3	5.8	2.5
16xall	6	6.5	3.5
18xall	6	7.5	3.5

Case Size

WV (Vdc)	Cap (uF)	Size (mm)	Rated Ripple current (mAmps/105°C /120Hz)
6.3	22	4x5.5	22
6.3	33	5x5.5	33
6.3	47	5x5.5	36
6.3	100	6.3x5.5	68
6.3	220	6.3x7.7	120
6.3	330	8x10.5	230
6.3	470	10x10.5	290
6.3	1000	10x10.5	360
10	22	5x5.5	30
10	33	5x5.5	35
10	47	6.3x5.5	52
10	100	6.3x7.7	81
10	220	8x10.5	142
10	330	10x10.5	280
10	470	10x10.5	305
16	10	4x5.5	18
16	22	5x5.5	31
16	33	6.3x5.5	48
16	47	6.3x5.5	51
16	100	6.3x7.7	83
16	220	10x10.5	222
16	330	10x10.5	305
16	470	10x10.5	330
25	4.7	4x5.5	16
25	10	4x5.5	26
25	22	6.3x5.5	44
25	33	6.3x5.5	50

WV (Vdc)	Cap (uF)	Size (mm)	Rated Ripple current (mAmps/105°C /120Hz)
25	47	6.3x7.7	66
25	100	8x10.5	118
25	220	10x10.5	300
25	330	10x10.5	395
25	470	10x10.5	470
35	4.7	4x5.5	16
35	10	5x5.5	27
35	22	6.3x5.5	45
35	33	6.3x7.7	58
35	47	8x10.5	93
35	100	10x10.5	155
35	220	10x10.5	340
35	330	10x10.5	420
50	0.1	4x5.5	1
50	0.22	4x5.5	3
50	0.33	4x5.5	3
50	0.47	4x5.5	5
50	1	4x5.5	8
50	2.2	4x5.5	12
50	3.3	4x5.5	17
50	4.7	5x5.5	22
50	10	6.3x5.5	33
50	22	6.3x7.7	58
50	33	8x10.5	140
50	47	8x10.5	170
50	100	10x10.5	300

MV Series Chip type ,Long Life, High CV



Features

- ◆ Chip type long life capacitance in large case sizes
- ◆ Chip type with Endurance of 5000 hours at +105°C
- ◆ Designed for surface mounting on high density PC board
- ◆ Applicable to automatic insertion machine using carrier tape
- ◆ Complied to the RoHS directive
- ◆ RoHS Compliant

Specifications

Item	Performance Characteristics						
Operating Temperature Range	-40~+105°C						
Rated Voltage Range	6.3~50 VDC						
Capacitance Range	0.1 to 1000 μF						
Capacitance Tolerance	±20%(120Hz,+20°C)						
Leakage Current (+20°C,max.)	I ≤ 0.01 CV or 3 (μA) After 2 minutes whichever is greater measured with rated working voltage applied.						
Dissipation Factor (tan δ , at 20°C , 120Hz)	Working Voltage(VDC)	6.3	10	16	25	35	50
	D.F.(%)max.	32	28	22	16	13	12
Low Temperature Characteristics (at 120Hz)	Impedance ratio max (at: 120Hz)						
	Working voltage(VDC)	6.3	10	16	25	35	50
	Z-25°C / Z+20°C	4	3	2	2	2	2
	Z-40°C / Z+20°C	10	7	5	3	3	3
Endurance	Test condition						
	Duration time	: 5000 Hrs					
	Ambient temperature	: +105°C					
	Applied voltage	: Rated DC working voltage					
	After test requirement at +20°C						
	Capacitance change	: Within ±30% of initial value					
	Dissipation factor	: Less than 300% of specified value					
	Leakage current	: Less than specified value					
Shelf Life	Test condition						
	Duration time	: 1000 Hrs					
	Ambient temperature	: +105°C					
	Applied voltage	: None					
	After test requirement at +20°C	: Same limits as Endurance.					
	Pre-treatment for measurements shall be conducted after application of DC working voltage for 30 minutes.						
Resistance to soldering heat	The following specifications shall be satisfied when the capacitors are restored to 20°C after exposing them at 250°C for 30 seconds.						
	Leakage current	Less than specified value					
	Capacitance change	Within ±10% of initial value					
	tan δ	Less than specified value					

Multiplier for Ripple Current vs. Frequency

CAP(μF)\Frequency(Hz)	60(50)	120	500	1K	≥10K
0.1 ≤ CAP ≤ 100 μF	0.8	1.0	1.20	1.30	1.50
100 < CAP ≤ 1000 μF	0.8	1.0	1.10	1.15	1.20

φD	L	A	B	C	W	P
4	5.5	4.3	4.3	4.9	0.5~0.8	1.0
5	5.5	5.3	5.3	5.9	0.5~0.8	1.4
6.3	5.5	6.6	6.6	7.2	0.5~0.8	2.2
6.3	6.1	6.6	6.6	7.2	0.5~0.8	2.2
6.3	7.7	6.6	6.6	7.2	0.5~0.8	2.2
8	6.5	8.3	8.3	9.0	0.5~0.8	2.3
8	10.5	8.3	8.3	9.0	0.7~1.1	3.1
10	10.5	10.3	10.3	11.0	0.7~1.1	4.5
12.5	14	13.0	13.0	13.9	1.0~1.4	4.5
16	17	17.0	17.0	18.0	1.0~1.4	6.6
16	21.5	17.0	17.0	18.0	1.0~1.4	6.6
18	16.5	19.0	19.0	20.0	1.0~1.4	6.6
18	21.5	19.0	19.0	20.0	1.0~1.4	6.6

Diagram of Dimensions:(unit:mm)

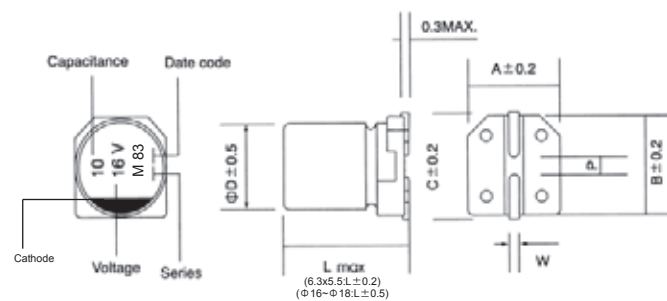

Recommended land pattern:(unit:mm)

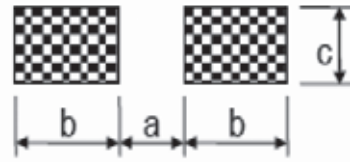

Φ DxL	a	b	c
4xall	1	2.6	1.6
5xall	1.4	3	1.6
6.3xall	2.1	3.5	1.6
8xL(height ≤6.5)	2.1	4.5	1.6
8xL(height >6.5)	2.8	4.2	1.9
10xall	4.3	4.4	1.9
12.5xall	4.3	5.8	2.5
16xall	6	6.5	3.5
18xall	6	7.5	3.5

Case Size

WV (Vdc)	Cap (uF)	Size (mm)	Rated Ripple current (mAmps/105°C /120Hz)
6.3	22	4x5.5	22
6.3	33	5x5.5	32
6.3	47	5x5.5	36
6.3	100	6.3x5.5	60
6.3	220	6.3x7.7	110
6.3	330	8x10.5	160
6.3	470	10x10.5	260
6.3	1000	10x10.5	340
10	22	5x5.5	28
10	33	5x5.5	34
10	47	6.3x5.5	48
10	100	6.3x7.7	79
10	220	8x10.5	140
10	330	8x10.5	210
10	330	10x10.5	240
10	470	8x10.5	250
10	470	10x10.5	280
10	1000	10x10.5	410
16	10	4x5.5	17
16	22	4x5.5	26
16	22	5x5.5	30
16	33	6.3x5.5	44
16	47	6.3x5.5	50
16	100	6.3x7.7	81
16	220	8x10.5	190
16	220	10x10.5	216
16	330	10x10.5	300
16	470	10x10.5	320
25	4.7	4x5.5	13
25	10	4x5.5	23
25	22	5x5.5	35

WV (Vdc)	Cap (uF)	Size (mm)	Rated Ripple current (mAmps/105°C /120Hz)
25	22	6.3x5.5	40
25	33	6.3x5.5	48
25	47	6.3x7.7	63
25	100	6.3x7.7	88
25	100	8x10.5	116
25	220	10x10.5	240
25	330	10x10.5	375
25	470	10x10.5	450
35	4.7	4x5.5	15
35	10	5x5.5	25
35	22	6.3x5.5	42
35	33	6.3x7.7	57
35	47	8x10.5	92
35	100	8x10.5	130
35	100	10x10.5	150
35	220	10x10.5	280
35	330	10x10.5	390
50	0.1	4x5.5	1
50	0.22	4x5.5	3
50	0.33	4x5.5	3
50	0.47	4x5.5	4
50	1	4x5.5	6
50	2.2	4x5.5	11
50	3.3	4x5.5	14
50	4.7	5x5.5	19
50	10	6.3x5.5	30
50	22	6.3x7.7	52
50	33	8x10.5	80
50	47	8x10.5	95
50	100	10x10.5	160

CV Series Chip type

Features

- ◆ Chip type ,Low impedance
- ◆ Chip type with load life of 7000 hours at +105°C
- ◆ Designed for surface mounting on high density PC board
- ◆ Applicable to automatic mounting machine using carrier tape
- ◆ Complied to the RoHS directive



Specifications

Item	Performance Characteristics						
Operating Temperature Range	-25 to +105°C						
Rated Voltage Range	6.3~50 VDC						
Capacitance Range	22 to 1500μF						
Capacitance Tolerance	±20%(120Hz,+20°C)						
Leakage Current (+20°C,max.)	I ≤ 0.01 CV or 3 (μA) After 2 minutes whichever is greater measured with rated working voltage applied.						
Dissipation Factor (tan δ , at 20°C , 120Hz)	Working Voltage(VDC)	6.3	10	16	25	35	50
	D.F.(%)max.	32	28	26	16	14	14
Low Temperature Characteristics (at 120Hz)	Impedance ratio max (at: 120Hz)						
	Working voltage(VDC)	6.3	10	16	25	35	50
	Z-25°C / Z+20°C	4	3	2	2	2	2
Endurance	Test condition						
	Duration time	: 7000 Hrs					
	Ambient temperature	: +105°C					
	Applied voltage	: Rated DC working voltage					
	After test requirement at +20°C						
	Capacitance change	: Within ±30% of initial value					
	Dissipation factor	: Less than 300% of specified value					
	Leakage current	: Less than specified value					
Shelf Life	Test condition						
	Duration time	: 1000 Hrs					
	Ambient temperature	: +105°C					
	Applied voltage	: None					
	After test requirement at +20°C	: Same limits as Endurance.					
	Pre-treatment for measurements shall be conducted after application of DC working voltage for 30 minutes.						
Resistance to soldering heat	The following specifications shall be satisfied when the capacitors are restored to 20°C after exposing them at 250°C for 30 seconds.						
	Leakage current	Less than specified value					
	Capacitance change	Within ±10% of initial value					
	tan δ	Less than specified value					

Multiplier for Ripple Current vs. Frequency

CAP(μ F)\Frequency(Hz)	60(50)	120	500	1K	10K~100K
0.1 ≤ CAP ≤ 100 μ F	0.53	0.67	0.8	0.87	1
100 < CAP ≤ 1000 μ F	0.67	0.83	0.92	0.96	1

φD	L	A	B	C	W	P
4	5.5	4.3	4.3	4.9	0.5~0.8	1.0
5	5.5	5.3	5.3	5.9	0.5~0.8	1.4
6.3	5.5	6.6	6.6	7.2	0.5~0.8	2.2
6.3	6.1	6.6	6.6	7.2	0.5~0.8	2.2
6.3	7.7	6.6	6.6	7.2	0.5~0.8	2.2
8	6.5	8.3	8.3	9.0	0.5~0.8	2.3
8	10.5	8.3	8.3	9.0	0.7~1.1	3.1
10	10.5	10.3	10.3	11.0	0.7~1.1	4.5
12.5	14	13.0	13.0	13.9	1.0~1.4	4.5
16	17	17.0	17.0	18.0	1.0~1.4	6.6
16	21.5	17.0	17.0	18.0	1.0~1.4	6.6
18	16.5	19.0	19.0	20.0	1.0~1.4	6.6
18	21.5	19.0	19.0	20.0	1.0~1.4	6.6

Diagram of Dimensions:(unit:mm)

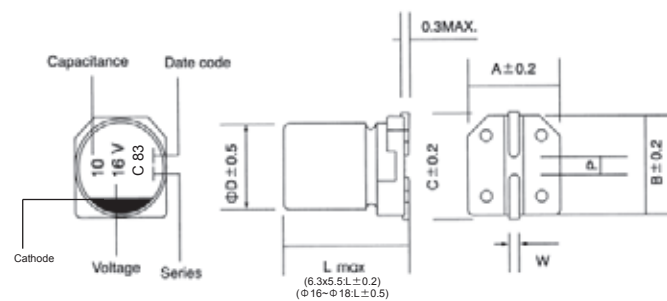

Recommended land pattern:(unit:mm)

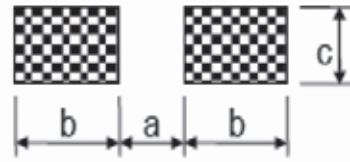

Φ DxL	a	b	c
4xall	1	2.6	1.6
5xall	1.4	3	1.6
6.3xall	2.1	3.5	1.6
8xL(height ≤6.5)	2.1	4.5	1.6
8xL(height >6.5)	2.8	4.2	1.9
10xall	4.3	4.4	1.9
12.5xall	4.3	5.8	2.5
16xall	6	6.5	3.5
18xall	6	7.5	3.5

Case Size

WV (Vdc)	Cap (uF)	Size (mm)	Rated Ripple current (mA _{rms} /105°C /100KHz)	Max ESR(Ω) at 20°C/100KHz
6.3	100	6.3x7.7	140	1.10
6.3	150	6.3x7.7	180	0.90
6.3	220	6.3x7.7	230	0.75
6.3	330	8x10.5	400	0.50
6.3	470	8x10.5	600	0.22
6.3	680	10x10.5	700	0.20
6.3	1000	12.5x14	1100	0.10
6.3	1500	16x17	1500	0.08
10	100	6.3x7.7	140	1.10
10	150	6.3x7.7	180	0.90
10	220	6.3x7.7	230	0.75
10	330	8x10.5	400	0.50
10	470	8x10.5	600	0.22
10	680	10x10.5	700	0.20
10	1000	12.5x14	1100	0.10
10	1500	16x17	1500	0.08
16	100	6.3x7.7	140	1.10
16	150	8x10.5	250	0.60
16	220	8x10.5	280	0.40
16	330	8x10.5	600	0.22
16	470	8x10.5	600	0.22
16	470	10x10.5	850	0.16
16	680	12.5x14	1100	0.10
16	1000	16x17	1500	0.08
25	22	6.3x7.7	95	1.50
25	33	6.3x7.7	120	1.30
25	47	6.3x7.7	140	1.10
25	100	8x10.5	280	0.70
25	150	8x10.5	380	0.60
25	220	8x10.5	600	0.22
25	330	8x10.5	650	0.20
25	390	10x10.5	750	0.19
25	470	10x10.5	850	0.16
25	680	12.5x14	1100	0.10
25	1000	16x17	1500	0.08
35	47	6.3x7.7	230	1.00
35	100	8x10.5	600	0.22
35	220	10x10.5	850	0.16
35	330	12.5x14	1100	0.10
35	470	16x17	1500	0.08
50	47	8x10.5	350	0.53
50	100	8x10.5	350	0.53
50	100	10x10.5	400	0.51
50	150	10x10.5	450	0.48
50	220	12.5x14	850	0.4
50	330	16x17	1100	0.3

NV Series

Features

- ◆ 85°C Non-polarized
- ◆ Reflow soldering is available
- ◆ Available for high density mounting
- ◆ RoHS Compliant



Specifications

Item	Performance Characteristics						
Operating Temperature Range	-40~ +85°C						
Rated Voltage Range	6.3~50 VDC						
Capacitance Range	0.1 to 560 μF						
Capacitance Tolerance	±20%(120Hz, +20°C)						
Leakage Current (+20°C, max.)	0.05 CV or 10 (μA) After 2 minutes, whichever is greater measured with rated working voltage applied						
Dissipation Factor (tan δ, at 20°C, 120Hz)	Working voltage(VDC)	6.3	10	16	25	35	50
	D.F.(%)max	24	20	17	17	15	15
Low Temperature Characteristics (at 120Hz)	Impedance ratio max						
	Rated voltage(VDC)	6.3	10	16	25	35	50
	Z-25°C / Z+20°C	4	3	2	2	2	2
	Z-40°C / Z+20°C	8	6	4	3	3	3
Endurance	Test conditions						
	Duration time	:2000 Hrs					
	Ambient temperature	:+85°C					
	Applied voltage	:Rated DC working voltage					
	After test requirement at +20°C:						
	Capacitance change	:Within ±25% of the initial value					
	Dissipation factor	:Not more than 200% of specified value					
	Leakage current	:Not more than the specified value					
Shelf Life	Test conditions						
	Duration time	:1000 Hrs					
	Ambient temperature	:+85°C					
	Applied voltage	:None					
	After test requirement at +20°C	: Same limits as Endurance.					
	Pre-treatment for measurements	: shall be conducted after application of DC working voltage for 30 minutes.					
Resistance to soldering heat	The capacitors shall be kept on the hot plate maintained at 250°C for 30 seconds. After removing from the hot plate and restored at room temperature, they meet the characteristic requirements listed under.						
	Leakage current	Less than specified value					
	Capacitance change	Within ±10% of initial value					
	tan δ	Less than specified value					

Multiplier for Ripple Current vs. Frequency

Frequency(Hz)	60(50)	120	500	1K	≥10K
Multiplier	0.8	1.0	1.20	1.30	1.50

φD	L	A	B	C	W	P
4	5.5	4.3	4.3	4.9	0.5~0.8	1.0
5	5.5	5.3	5.3	5.9	0.5~0.8	1.4
6.3	5.5	6.6	6.6	7.2	0.5~0.8	2.2
6.3	6.1	6.6	6.6	7.2	0.5~0.8	2.2
6.3	7.7	6.6	6.6	7.2	0.5~0.8	2.2
8	6.5	8.3	8.3	9.0	0.5~0.8	2.3
8	10.5	8.3	8.3	9.0	0.7~1.1	3.1
10	10.5	10.3	10.3	11.0	0.7~1.1	4.5
12.5	14	13.0	13.0	13.9	1.0~1.4	4.5
16	17	17.0	17.0	18.0	1.0~1.4	6.6
16	21.5	17.0	17.0	18.0	1.0~1.4	6.6
18	16.5	19.0	19.0	20.0	1.0~1.4	6.6
18	21.5	19.0	19.0	20.0	1.0~1.4	6.6

Diagram of Dimensions:(unit:mm)

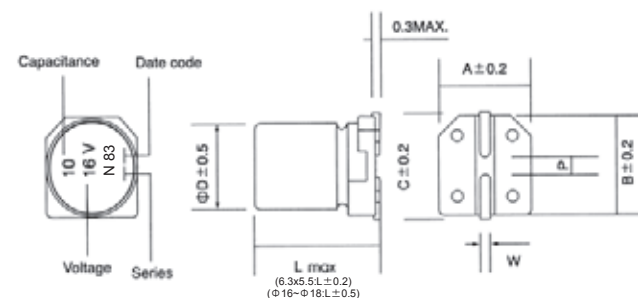

Recommended land pattern:(unit:mm)

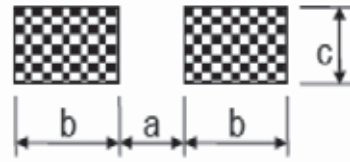

Φ DxL	a	b	c
4xall	1	2.6	1.6
5xall	1.4	3	1.6
6.3xall	2.1	3.5	1.6
8xL(height ≤6.5)	2.1	4.5	1.6
8xL(height >6.5)	2.8	4.2	1.9
10xall	4.3	4.4	1.9
12.5xall	4.3	5.8	2.5
16xall	6	6.5	3.5
18xall	6	7.5	3.5

Case Size

WV (Vdc)	Cap (uF)	Size (mm)	Rated Ripple current (mArms/85°C /120Hz)
6.3	10	4x5.5	15
6.3	22	4x5.5	28
6.3	22	5x5.5	32
6.3	33	5x5.5	37
6.3	47	6.3x5.5	45
6.3	100	6.3x7.7	65
6.3	100	8x6.5	70
6.3	220	8x10.5	120
6.3	330	8x10.5	160
6.3	470	10x10.5	190
6.3	560	10x10.5	220
10	10	4x5.5	17
10	22	5x5.5	33
10	22	6.3x5.5	37
10	33	6.3x5.5	41
10	47	6.3x5.5	50
10	100	6.3x7.7	75
10	100	8x6.5	80
10	220	8x10.5	150
10	330	10x10.5	180
16	3.3	4x5.5	12
16	4.7	4x5.5	12
16	10	4x5.5	23
16	10	5x5.5	23
16	22	5x5.5	37
16	22	6.3x5.5	37
16	33	6.3x5.5	49
16	47	6.3x7.7	51
16	47	8x6.5	55
16	100	8x10.5	100
16	220	10x10.5	170
25	3.3	4x5.5	12
25	3.3	5x5.5	12
25	4.7	4x5.5	16

WV (Vdc)	Cap (uF)	Size (mm)	Rated Ripple current (mArms/85°C /120Hz)
25	4.7	5x5.5	16
25	10	5x5.5	27
25	10	6.3x5.5	27
25	22	6.3x5.5	40
25	33	6.3x7.7	51
25	33	8x6.5	55
25	47	6.3x7.7	56
25	47	8x6.5	60
25	100	8x10.5	130
35	2.2	4x5.5	8.4
35	3.3	4x5.5	16
35	3.3	5x5.5	16
35	4.7	4x5.5	18
35	4.7	5x5.5	18
35	10	6.3x5.5	29
35	22	6.3x5.5	45
35	33	8x10.5	58
35	47	8x10.5	64
50	0.1	4x5.5	1
50	0.22	4x5.5	2
50	0.33	4x5.5	2.8
50	0.47	4x5.5	4
50	1	4x5.5	8.4
50	2.2	4x5.5	13
50	2.2	5x5.5	13
50	3.3	4x5.5	17
50	3.3	5x5.5	17
50	4.7	5x5.5	20
50	4.7	6.3x5.5	20
50	10	6.3x5.5	32
50	22	8x10.5	60
50	33	10x10.5	75
50	47	10x10.5	100

KV Series

Features

- ◆ 85°C Low leakage current case diameter $\phi 4 \sim \phi 8$
- ◆ Reflow soldering is available
- ◆ Available for high density mounting
- ◆ RoHS Compliant



Specifications

Item	Performance Characteristics						
Operating Temperature Range	-40~ +85°C						
Rated Voltage Range	6.3~50 VDC						
Capacitance Range	0.1 to 330 μ F						
Capacitance Tolerance	$\pm 20\%$ (120Hz,+20°C)						
Leakage Current (+20°C,max.)	I \leq 0.002 CV or 0.4 (μ A) After 2 minutes, whichever is greater measured with rated working voltage applied						
Dissipation Factor (tan δ , at 20°C , 120Hz)	Working voltage(VDC)	6.3	10	16	25	35	50
	D.F.(%)max	26	22	18	16	14	12
Low Temperature Characteristics (at 120Hz)	Impedance ratio max						
	Rated voltage(VDC)	6.3	10	16	25	35	50
	Z-25°C / Z+20°C	4	3	2	2	2	2
	Z-40°C / Z+20°C	8	6	4	3	3	3
Endurance	Test conditions						
	Duration time	:1000 Hrs					
	Ambient temperature	:+85°C					
	Applied voltage	:Rated DC working voltage					
	After test requirement at +20°C:	:Within $\pm 25\%$ of the initial value					
	Capacitance change	:Not more than 200% of specified value					
	Dissipation factor	:Not more than the specified value					
	Leakage current	:Not more than the specified value					
Shelf Life	Test conditions						
	Duration time	:1000 Hrs					
	Ambient temperature	:+85°C					
	Applied voltage	:None					
	After test requirement at +20°C	: Same limits as Endurance.					
	Pre-treatment for measurements shall be conducted after application of DC working voltage for 30 minutes.						
Resistance to soldering heat	The capacitors shall be kept on the hot plate maintained at 250°C for 30 seconds. After removing from the hot plate and restored at room temperature, they meet the characteristic requirements listed under.						
	Leakage current	Less than specified value					
	Capacitance change	Within $\pm 10\%$ of initial value					
	tan δ	Less than specified value					

Multiplier for Ripple Current vs. Frequency

CAP(μ F)\Frequency(Hz)	60(50)	120	500	1K	$\geq 10K$
$0.1 \leq CAP \leq 100 \mu F$	0.8	1.0	1.20	1.30	1.50
$100 < CAP \leq 330 \mu F$	0.8	1.0	1.10	1.15	1.20

ϕD	L	A	B	C	W	P
4	5.5	4.3	4.3	4.9	0.5~0.8	1.0
5	5.5	5.3	5.3	5.9	0.5~0.8	1.4
6.3	5.5	6.6	6.6	7.2	0.5~0.8	2.2
6.3	6.1	6.6	6.6	7.2	0.5~0.8	2.2
6.3	7.7	6.6	6.6	7.2	0.5~0.8	2.2
8	6.5	8.3	8.3	9.0	0.5~0.8	2.3
8	10.5	8.3	8.3	9.0	0.7~1.1	3.1
10	10.5	10.3	10.3	11.0	0.7~1.1	4.5
12.5	14	13.0	13.0	13.9	1.0~1.4	4.5
16	17	17.0	17.0	18.0	1.0~1.4	6.6
16	21.5	17.0	17.0	18.0	1.0~1.4	6.6
18	16.5	19.0	19.0	20.0	1.0~1.4	6.6
18	21.5	19.0	19.0	20.0	1.0~1.4	6.6

Diagram of Dimensions:(unit:mm)

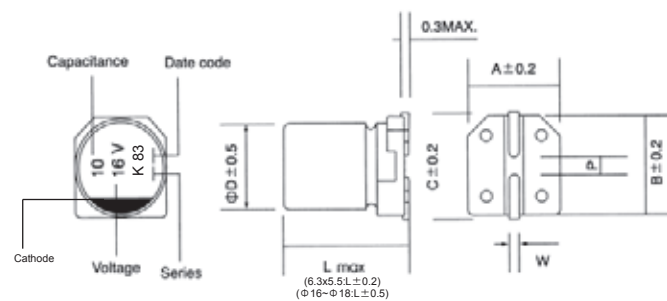

Recommended land pattern:(unit:mm)

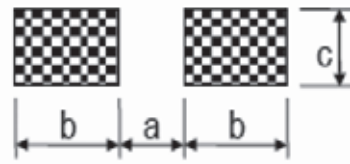

Φ DxL	a	b	c
4xall	1	2.6	1.6
5xall	1.4	3	1.6
6.3xall	2.1	3.5	1.6
8xL(height ≤6.5)	2.1	4.5	1.6
8xL(height >6.5)	2.8	4.2	1.9
10xall	4.3	4.4	1.9
12.5xall	4.3	5.8	2.5
16xall	6	6.5	3.5
18xall	6	7.5	3.5

Case Size

WV (Vdc)	Cap (uF)	Size (mm)	Rated Ripple current (mArms/85°C /120Hz)
6.3	10	4x5.5	15
6.3	22	4x5.5	28
6.3	33	4x5.5	37
6.3	47	4x5.5	45
6.3	100	5x5.5	70
6.3	220	6.3x7.7	102
6.3	220	8x6.5	110
6.3	330	6.3x7.7	155
6.3	330	8x6.5	170
10	10	4x5.5	23
10	22	4x5.5	33
10	33	5x5.5	41
10	47	6.3x5.5	52
10	100	6.3x7.7	75
10	100	8x6.5	80
10	220	6.3x7.7	125
10	220	8x6.5	135
16	4.7	4x5.5	10
16	10	4x5.5	23
16	22	5x5.5	37
16	33	6.3x5.5	49
16	47	6.3x5.5	58
16	100	6.3x7.7	85
16	100	8x6.5	92
25	3.3	4x5.5	10
25	4.7	4x5.5	16
25	10	4x5.5	27
25	22	5x5.5	42

WV (Vdc)	Cap (uF)	Size (mm)	Rated Ripple current (mArms/85°C /120Hz)
25	33	6.3x5.5	52
25	47	6.3x7.7	65
25	47	8x6.5	70
25	100	6.3x7.7	102
25	100	8x6.5	110
35	2.2	4x5.5	8
35	3.3	4x5.5	15
35	4.7	4x5.5	18
35	10	6.3x5.5	29
35	22	6.3x5.5	46
35	33	6.3x7.7	58
35	33	8x6.5	62
35	47	6.3x7.7	75
35	47	8x6.5	80
50	0.1	4x5.5	1
50	0.22	4x5.5	2
50	0.33	4x5.5	3
50	0.47	4x5.5	4
50	1	4x5.5	8
50	2.2	4x5.5	13
50	3.3	4x5.5	17
50	4.7	6.3x5.5	20
50	10	6.3x5.5	33
50	22	6.3x7.7	48
50	22	8x6.5	52
50	33	6.3x7.7	66
50	33	8x6.5	71

ZV Series

Features

- ◆ Low impedance 100 KHz
- ◆ Reflow soldering is available
- ◆ Available for high density mounting
- ◆ Endurance 2000~5000 hrs at 105°C
- ◆ RoHS Compliant



Specifications

Item	Performance Characteristics						
Operating Temperature Range	-55~ +105°C						
Rated Voltage Range	6.3~50 VDC						
Capacitance Range	2.2 to 6800 μF						
Capacitance Tolerance	±20%(120Hz, +20°C)						
Leakage Current (+20°C, max.)	I ≤ 0.01 CV or 3 (μA) After 2 minutes whichever is greater measured with rated working voltage applied.						
Dissipation Factor (tan δ , at 20°C , 120Hz)	Working voltage(VDC)	6.3	10	16	25	35	50
	D.F.(%)max	26	19	16	14	14	12
Low Temperature Characteristics (at 120Hz)	Impedance ratio max						
	Rated voltage(VDC)	6.3	10	16	25	35	50
	Z-25°C / Z+20°C	4	3	2	2	2	2
	Z-40°C / Z+20°C	8	6	4	3	3	3
Endurance	Test conditions						
	Duration time	:2000 Hrs					
	Ambient temperature	:+105°C					
	Applied voltage	:Rated DC working voltage					
	After test requirement at +105°C:						
	Capacitance change	:Within ±25% of the initial value					
Dissipation factor	:Less than 200% of specified value						
Leakage current	:Less than the initial specified value						
Shelf Life	Test conditions						
	Duration time	:1000 Hrs					
	Ambient temperature	:+105°C					
	Applied voltage	:None					
	After test requirement at +20°C : Same limits as Endurance. Pre-treatment for measurements shall be conducted after application of DC working voltage for 30 minutes.						
Resistance to soldering heat	The capacitors shall be kept on the hot plate maintained at 250°C for 30 seconds. After removing from the hot plate and restored at room temperature, they meet the characteristic requirements listed under.						
	Leakage current	Less than specified value					
	Capacitance change	Within ±10% of initial value					
	tan δ	Less than specified value					

Multiplier for Ripple Current vs. Frequency

CAP(μF)\Frequency(Hz)	60(50)	120	500	1K	10K	50K-100K
CAP ≤ 10	0.47	0.59	0.76	0.85	0.97	1.0
10 < CAP	0.52	0.65	0.80	0.89	0.97	1.0

φD	L	A	B	C	W	P
4	5.5	4.3	4.3	4.9	0.5~0.8	1.0
5	5.5	5.3	5.3	5.9	0.5~0.8	1.4
6.3	5.5	6.6	6.6	7.2	0.5~0.8	2.2
6.3	6.1	6.6	6.6	7.2	0.5~0.8	2.2
6.3	7.7	6.6	6.6	7.2	0.5~0.8	2.2
8	6.5	8.3	8.3	9.0	0.5~0.8	2.3
8	10.5	8.3	8.3	9.0	0.7~1.1	3.1
10	10.5	10.3	10.3	11.0	0.7~1.1	4.5
12.5	14	13.0	13.0	13.9	1.0~1.4	4.5
16	17	17.0	17.0	18.0	1.0~1.4	6.6
16	21.5	17.0	17.0	18.0	1.0~1.4	6.6
18	16.5	19.0	19.0	20.0	1.0~1.4	6.6
18	21.5	19.0	19.0	20.0	1.0~1.4	6.6

Diagram of Dimensions:(unit:mm)

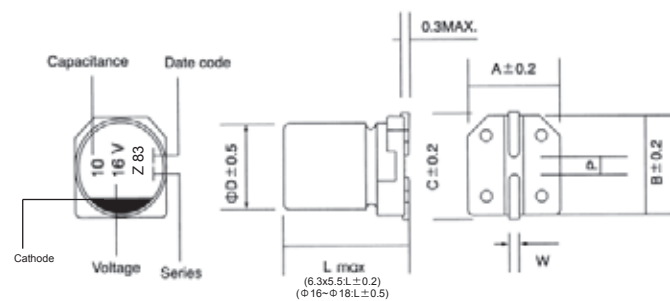

Recommended land pattern:(unit:mm)



Φ DxL	a	b	c
4xall	1	2.6	1.6
5xall	1.4	3	1.6
6.3xall	2.1	3.5	1.6
8xL(height ≤6.5)	2.1	4.5	1.6
8xL(height >6.5)	2.8	4.2	1.9
10xall	4.3	4.4	1.9
12.5xall	4.3	5.8	2.5
16xall	6	6.5	3.5
18xall	6	7.5	3.5

Case Size

WV (Vdc)	Cap (uF)	Size (mm)	Ripple current (mArms/105°C /100KHz)	Max ESR 20°C 100KHz(Ω)
6.3	22	4x5.5	53	3.50
6.3	27	4x5.5	65	3.20
6.3	33	4x5.5	80	2.80
6.3	33	5x5.5	82	2.60
6.3	47	4x5.5	82	2.40
6.3	47	5x5.5	85	2.20
6.3	56	5x5.5	94	1.70
6.3	68	5x5.5	100	1.60
6.3	68	6.3x5.5	120	1.30
6.3	100	5x5.5	110	1.50
6.3	100	6.3x5.5	160	1.100
6.3	150	6.3x5.5	170	0.950
6.3	150	6.3x7.7	195	0.85
6.3	220	6.3x5.5	195	0.60
6.3	220	6.3x7.7	210	0.57
6.3	330	6.3x7.7	230	0.51
6.3	330	8x6.5	250	0.49
6.3	470	8x10.5	380	0.45
6.3	680	8x10.5	420	0.42
6.3	1000	8x10.5	470	0.28
6.3	1000	10x10.5	500	0.25
6.3	1200	10x10.5	530	0.20
6.3	1500	10x10.5	570	0.170
6.3	3300	12.5x14	900	0.15
6.3	6800	16x17	1030	0.1
10	22	4x5.5	80	2.60
10	27	5x5.5	85	2.40
10	33	4x5.5	85	2.30
10	33	5x5.5	110	2.10
10	47	5x5.5	130	2.00
10	47	6.3x5.5	160	1.50
10	56	6.3x5.5	180	1.45
10	68	6.3x5.5	195	1.40
10	68	6.3x7.7	210	1.30
10	100	5x5.5	183	1.30
10	100	6.3x5.5	210	1.30
10	100	6.3x7.7	230	1.20
10	150	6.3x5.5	220	1.00
10	150	8x6.5	240	0.80
10	220	6.3x7.7	245	0.60
10	220	8x6.5	255	0.55
10	330	8x10.5	400	0.36
10	470	8x10.5	470	0.32
10	680	10x10.5	620	0.29
10	1000	10x10.5	670	0.25
10	2200	12.5x14	900	0.15
10	4700	16x17	1030	0.11
16	10	4x5.5	65	5.00

WV (Vdc)	Cap (uF)	Size (mm)	Ripple current (mArms/105°C /100KHz)	Max ESR 20°C 100KHz(Ω)
16	15	4x5.5	70	4.60
16	22	4x5.5	83	3.00
16	22	5x5.5	110	2.60
16	27	5x5.5	135	1.90
16	33	5x5.5	160	2.20
16	33	6.3x5.5	170	1.50
16	47	5x5.5	170	2.00
16	47	6.3x5.5	185	1.50
16	56	6.3x5.5	195	1.30
16	68	6.3x5.5	205	1.20
16	68	6.3x7.7	210	1.10
16	68	8x6.5	220	1.00
16	100	6.3x5.5	210	1.10
16	100	6.3x7.7	220	0.90
16	150	6.3x7.7	225	0.80
16	150	8x6.5	240	0.70
16	220	6.3x7.7	250	0.75
16	220	8x6.5	260	0.66
16	330	8x10.5	470	0.34
16	470	8x10.5	520	0.30
16	680	10x10.5	600	0.26
16	1200	12.5x14	900	0.15
16	1500	12.5x14	900	0.15
16	3300	16x17	1030	0.11
25	4.7	4x5.5	53	5.00
25	6.8	4x5.5	58	4.50
25	10	4x5.5	74	3.70
25	10	5x5.5	80	2.60
25	15	5x5.5	100	2.20
25	15	6.3x5.5	115	1.80
25	22	5x5.5	128	1.70
25	22	6.3x5.5	140	1.50
25	27	6.3x5.5	145	1.40
25	33	5x5.5	145	1.40
25	33	6.3x5.5	175	1.30
25	47	6.3x5.5	180	1.20
25	47	6.3x7.7	195	0.80
25	47	8x6.5	220	0.75
25	56	6.3x5.5	195	1.15
25	68	6.3x5.5	200	1.10
25	68	6.3x7.7	210	0.75
25	68	8x6.5	230	0.70
25	100	6.3x7.7	220	0.75
25	100	8x6.5	250	0.70
25	150	8x10.5	420	0.50
25	220	8x10.5	480	0.30
25	220	10x10.5	500	0.28
25	330	8x10.5	510	0.26

WV (Vdc)	Cap (uF)	Size (mm)	Ripple current (mAmps/105°C /100KHz)	Max ESR 20°C 100KHz(Ω)
25	470	10x10.5	570	0.18
25	1000	12.5x14	900	0.15
25	2200	16x17	1030	0.11
35	2.2	4x5.5	53	5
35	3.3	4x5.5	53	5
35	4.7	4x5.5	53	5
35	6.8	4x5.5	65	4
35	6.8	5x5.5	85	3
35	10	4x5.5	90	4
35	10	5x5.5	98	3
35	10	6.3x5.5	110	2
35	15	5x5.5	120	2
35	15	6.3x5.5	140	2
35	22	5x5.5	140	1
35	22	6.3x5.5	150	1
35	27	6.3x5.5	165	1
35	33	6.3x5.5	185	1
35	33	6.3x7.7	210	1
35	33	8x6.5	230	1
35	47	6.3x5.5	200	1
35	47	6.3x7.7	220	1
35	47	8x6.5	240	1
35	56	6.3x7.7	230	1
35	68	6.3x7.7	240	0.7
35	68	8x6.5	250	0.68
35	100	6.3x7.7	270	0.67
35	100	8x10.5	350	0.50

WV (Vdc)	Cap (uF)	Size (mm)	Ripple current (mAmps/105°C /100KHz)	Max ESR 20°C 100KHz(Ω)
35	150	8x10.5	430	0.45
35	220	8x10.5	450	0.25
35	330	10x10.5	570	0.23
35	470	12.5x14	900	0.15
35	680	12.5x14	900	0.15
35	1500	16x17	1030	0.11
50	2.2	4x5.5	53	5.00
50	3.3	4x5.5	53	5.000
50	4.7	4x5.5	53	5.000
50	6.8	5x5.5	65	4.00
50	10	5x5.5	90	3.50
50	10	6.3x5.5	100	2.50
50	15	6.3x5.5	130	1.80
50	22	6.3x5.5	140	1.50
50	27	6.3x7.7	160	1.35
50	33	6.3x7.7	170	0.80
50	33	8x6.5	180	0.75
50	47	6.3x7.7	200	0.79
50	47	8x6.5	220	0.72
50	56	8x10.5	260	0.680
50	68	8x10.5	300	0.60
50	100	8x10.5	310	0.6
50	150	10x10.5	540	0.28
50	220	10x10.5	570	0.26
50	330	12.5x14	620	0.25
50	1000	16x17	820	0.20

DV Series Chip type

Features

- ◆ Chip type ,Low impedance
- ◆ Chip type with Endurance of 2000~5000 hours at +105°C
- ◆ Designed for surface mounting on high density PC board
- ◆ Applicable to automatic mounting machine using carrier tape
- ◆ Complied to the RoHS directive



Specifications

Item	Performance Characteristics									
Operating Temperature Range	-55~ +105°C									
Rated Voltage Range	6.3~100 VDC									
Capacitance Range	1 to 6800 μF									
Capacitance Tolerance	±20%(120Hz,+20°C)									
Leakage Current (+20°C,max.)	I ≤ 0.01 CV or 3 (μA) After 2 minutes whichever is greater measured with rated working voltage applied.									
Dissipation Factor (tan δ , at 20°C , 120Hz)	Working voltage(VDC)	6.3	10	16	25	35	50	63	80	100
	D.F.(%)max	24	19	16	14	14	12	10	9	8
Low Temperature Characteristics (at 120Hz)	Impedance ratio max									
	Rated voltage(VDC)	6.3	10	16	25	35	50	63	80	100
	Z-25°C / Z+20°C	2	2	2	2	2	2	2	2	2
	Z-40°C / Z+20°C	8	6	4	4	3	3	3	3	3
Endurance	Test conditions									
	Duration time	:2000 Hrs (φ 12.5~16:5000H)								
Ambient temperature	:+105°C									
Applied voltage	:Rated DC working voltage									
After test requirement at +20°C :										
Capacitance change	:Within ±30% of initial value									
Dissipation factor	:Less than 300% of specified value									
Leakage current	:Less than specified value									
Shelf Life	Test conditions									
	Duration time	:1000 Hrs								
Ambient temperature	:+105°C									
Applied voltage	:None									
After test requirement at +20°C : Same limits as Endurance.										
Pre-treatment for measurements shall be conducted after application of DC working voltage for 30 minutes.										
Resistance to soldering heat	The following specifications shall be satisfied when the capacitors are restored to 20°C after exposing them at 250°C for 30 seconds.									
	Leakage current	Less than specified value								
	Capacitance change	Within ±10% of initial value								
	tan δ	Less than specified value								

SMD

Multiplier for Ripple Current vs. Frequency

CAP(μF)\Frequency(Hz)	60(50)	120	500	1K	10K	50K-100K
CAP ≤ 10	0.47	0.59	0.76	0.85	0.97	1.0
10 < CAP	0.52	0.65	0.80	0.89	0.97	1.0

φD	L	A	B	C	W	P
4	5.5	4.3	4.3	4.9	0.5~0.8	1.0
5	5.5	5.3	5.3	5.9	0.5~0.8	1.4
6.3	5.5	6.6	6.6	7.2	0.5~0.8	2.2
6.3	6.1	6.6	6.6	7.2	0.5~0.8	2.2
6.3	7.7	6.6	6.6	7.2	0.5~0.8	2.2
8	6.5	8.3	8.3	9.0	0.5~0.8	2.3
8	10.5	8.3	8.3	9.0	0.7~1.1	3.1
10	10.5	10.3	10.3	11.0	0.7~1.1	4.5
12.5	14	13.0	13.0	13.9	1.0~1.4	4.5
16	17	17.0	17.0	18.0	1.0~1.4	6.6
16	21.5	17.0	17.0	18.0	1.0~1.4	6.6
18	16.5	19.0	19.0	20.0	1.0~1.4	6.6
18	21.5	19.0	19.0	20.0	1.0~1.4	6.6

Diagram of Dimensions:(unit:mm)

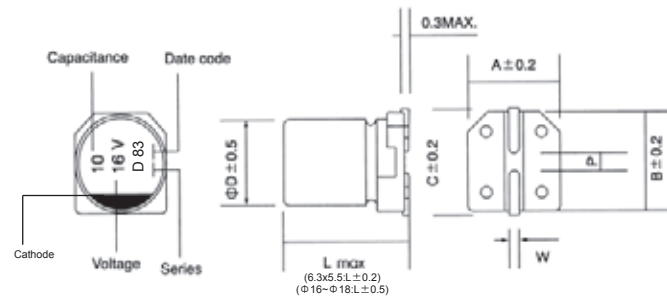

Recommended land pattern:(unit:mm)

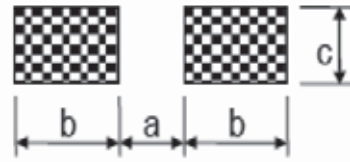

Φ DxL	a	b	c
4xall	1	2.6	1.6
5xall	1.4	3	1.6
6.3xall	2.1	3.5	1.6
8xL(height ≤6.5)	2.1	4.5	1.6
8xL(height >6.5)	2.8	4.2	1.9
10xall	4.3	4.4	1.9
12.5xall	4.3	5.8	2.5
16xall	6	6.5	3.5
18xall	6	7.5	3.5

Case Size

WV (Vdc)	Cap (uF)	Size (mm)	Ripple current (mArms/105°C /100KHz)	Max ESR 20°C 100KHz(Ω)
6.3	22	4x5.5	75	2.20
6.3	27	4x5.5	79	1.98
6.3	33	4x5.5	82	1.90
6.3	33	5x5.5	130	1.30
6.3	47	4x5.5	86	1.88
6.3	47	5x5.5	150	1.10
6.3	56	5x5.5	150	1.10
6.3	68	5x5.5	160	0.90
6.3	68	6.3x5.5	220	0.55
6.3	100	5x5.5	170	0.80
6.3	100	6.3x5.5	230	0.53
6.3	150	6.3x5.5	235	0.51
6.3	150	8x6.5	250	0.48
6.3	220	6.3x7.7	260	0.45
6.3	220	6.3x5.5	240	0.48
6.3	330	6.3x7.7	275	0.36
6.3	330	8x6.5	290	0.34
6.3	470	8x10.5	450	0.28
6.3	680	8x10.5	500	0.25
6.3	1000	8x10.5	530	0.20
6.3	1000	10x10.5	570	0.17
6.3	1200	10x10.5	600	0.16
6.3	1500	10x10.5	650	0.13
6.3	1800	10x10.5	860	0.08
6.3	3300	12.5x14	1100	0.080
6.3	6800	16x17	1250	0.052
10	22	4x5.5	80	2.20
10	27	5x5.5	125	1.90
10	33	4x5.5	90	1.85
10	33	5x5.5	150	1.20
10	47	5x5.5	165	1.10
10	47	6.3x5.5	180	0.59
10	56	6.3x5.5	210	0.57
10	68	6.3x5.5	220	0.55
10	100	5x5.5	210	0.80
10	100	6.3x5.5	240	0.53
10	150	6.3x5.5	250	0.49
10	150	8x6.5	260	0.47
10	220	6.3x7.7	270	0.44
10	220	8x6.5	285	0.40
10	330	8x10.5	500	0.25
10	470	8x10.5	550	0.25
10	680	10x10.5	680	0.20
10	1000	10x10.5	740	0.15
10	2200	12.5x14	1100	0.080
10	4700	16x17	1250	0.052
16	10	4x5.5	80	2.20

WV (Vdc)	Cap (uF)	Size (mm)	Ripple current (mArms/105°C /100KHz)	Max ESR 20°C 100KHz(Ω)
16	15	4x5.5	85	2.00
16	22	4x5.5	90	1.98
16	22	5x5.5	140	1.60
16	27	5x5.5	170	0.74
16	33	6.3x5.5	185	0.60
16	47	5x5.5	195	1.05
16	47	6.3x5.5	210	0.58
16	56	6.3x5.5	220	0.56
16	68	6.3x5.5	230	0.54
16	68	8x6.5	240	0.50
16	100	6.3x5.5	255	0.52
16	150	6.3x7.7	265	0.45
16	150	8x6.5	270	0.44
16	220	6.3x7.7	275	0.43
16	220	8x6.5	285	0.41
16	330	8x10.5	550	0.25
16	470	8x10.5	590	0.22
16	680	10x10.5	720	0.16
16	1500	12.5x14	1100	0.080
16	3300	16x17	1250	0.052
25	6.8	4x5.5	70	2.80
25	10	4x5.5	85	2.10
25	15	5x5.5	125	1.90
25	22	5x5.5	145	1.20
25	22	6.3x5.5	160	1.15
25	27	6.3x5.5	200	0.62
25	33	5x5.5	160	1.05
25	33	6.3x5.5	220	0.58
25	47	6.3x7.7	230	0.54
25	47	6.3x5.5	220	0.56
25	56	6.3x5.5	230	0.54
25	68	6.3x5.5	240	0.48
25	68	8x6.5	260	0.45
25	100	6.3x7.7	290	0.38
25	100	8x6.5	300	0.36
25	150	8x10.5	480	0.25
25	220	8x10.5	530	0.22
25	330	8x10.5	570	0.20
25	470	10x10.5	650	0.15
25	1000	12.5x14	1100	0.080
25	2200	16x17	1250	0.052
35	3.3	4x5.5	80	2.80
35	4.7	4x5.5	85	2.50
35	6.8	4x5.5	88	2.20
35	10	4x5.5	90	2.00
35	10	5x5.5	125	1.40
35	15	5x5.5	140	1.20

WV (Vdc)	Cap (uF)	Size (mm)	Ripple current (mA rms/105°C /100KHz)	Max ESR 20°C 100KHz(Ω)
35	22	5x5.5	155	1.10
35	22	6.3x5.5	170	1.05
35	27	6.3x5.5	210	0.60
35	33	6.3x5.5	230	0.54
35	33	8x6.5	260	0.51
35	47	6.3x5.5	240	0.53
35	47	8x6.5	250	0.49
35	56	6.3x7.7	250	0.49
35	68	6.3x7.7	265	0.40
35	100	6.3x7.7	300	0.38
35	100	8x10.5	420	0.28
35	150	8x10.5	510	0.24
35	220	8x10.5	570	0.21
35	330	10x10.5	650	0.15
35	470	12.5x14	1100	0.08
35	680	12.5x14	1100	0.080
35	1500	16x17	1250	0.052
50	1	4x5.5	55	4.50
50	2.2	4x5.5	55	4.50
50	3.3	4x5.5	55	4.50
50	4.7	4x5.5	55	4.50
50	6.8	5x5.5	75	3.80
50	10	5x5.5	95	2.80
50	10	6.3x5.5	130	2.20
50	15	6.3x5.5	140	1.60
50	22	6.3x5.5	150	1.30
50	27	6.3x7.7	180	1.20
50	33	6.3x7.7	190	0.71
50	33	8x6.5	200	0.70
50	47	6.3x7.7	230	0.70
50	47	8x6.5	240	0.69
50	56	8x10.5	300	0.52
50	68	8x10.5	320	0.50

WV (Vdc)	Cap (uF)	Size (mm)	Ripple current (mA rms/105°C /100KHz)	Max ESR 20°C 100KHz(Ω)
50	100	8x10.5	350	0.46
50	150	10x10.5	600	0.25
50	220	10x10.5	650	0.23
50	330	12.5x14	800	0.210
50	1000	16x17	1000	0.078
63	4.7	5x5.5	45	2.80
63	10	6.3x5.5	80	1.60
63	22	6.3x7.7	150	1.10
63	33	8x10.5	230	0.80
63	47	8x10.5	260	0.55
63	68	10x10.5	380	0.40
63	100	10x10.5	400	0.28
63	100	12.5x14	520	0.26
63	150	12.5x14	780	0.20
63	220	12.5x14	810	0.18
63	470	16x17	1390	0.085
80	4.7	6.3x5.5	50	3.80
80	10	6.3x7.7	70	3.0
80	22	6.3x7.7	110	1.70
80	33	8x10.5	200	1.10
80	47	10x10.5	320	0.90
80	68	10x10.5	490	0.65
80	100	12.5x14	580	0.42
80	220	16x17	930	0.26
100	10	6.3x7.7	65	4.00
100	22	8x10.5	110	2.00
100	33	10x10.5	180	1.30
100	47	10x10.5	370	1.00
100	47	12.5x14	480	0.95
100	68	12.5x14	580	0.60
100	100	12.5x14	620	0.50
100	220	16x17	1050	0.28

RV Series Chip type

Features

- ◆ Chip type ,Low impedance
- ◆ Chip type with Endurance of 5000 hours at +105°C
- ◆ Designed for surface mounting on high density PC board
- ◆ Applicable to automatic mounting machine using carrier tape
- ◆ Complied to the RoHS directive



Specifications

Item	Performance Characteristics											
Operating Temperature Range	-55 to +105°C	-40 to +105°C										
Rated Voltage Range	6.3 to 100 VDC	160~450 VDC										
Capacitance Range	1.0 to 6800µF	2.2 to 68µF										
Capacitance Tolerance	±20%(120Hz,+20°C)											
Leakage Current (+20°C,max.)	I ≤ 0.01 CV or 3 (µA) whichever is greater (2 minutes)	I ≤ 0.04 CV+100 µA (1 minute)										
Dissipation Factor (tan δ , at 20°C , 120Hz)	Working voltage(VDC)											
	6.3	10	16	25	35	50	63	80	100	160~250	>250	
Low Temperature Characteristics (Impedance ratio at 120Hz)	D.F.(%)max											
	22	19	16	14	14	12	10	9	8	15	20	
	Impedance ratio max											
Endurance	Rated voltage(VDC)											
	6.3	10	16	25	35	50	63	80	100	160~250	400	450
	Z-25°C / Z+20°C											
Shelf Life	Z-40°C / Z+20°C											
	8	6	4	4	3	3	3	3	3	6	10	15
Resistance to soldering heat	Test condition											
	Duration time : 5000hours (2000 hours for φD ≤ 6.3)											
	Ambient temperature : +105°C											
	Applied voltage : Rated DC working voltage											
Multiplier for Ripple Current vs. Frequency	After test requirement at +20°C											
	Capacitance change : Within ±30% of initial value											
	Dissipation factor : Less than 300% of specified value											
	Leakage current : Less than specified value											
Diagram of Dimensions:(unit:mm)	Test condition											
	Duration time : 1000Hrs											
	Ambient temperature : +105°C											
	Applied voltage : None											
Multiplier for Ripple Current vs. Frequency	After test requirement at +20°C: Same limits as Endurance.											
	Pre-treatment for measurements shall be conducted after application of DC working voltage for 30 minutes.											
	The following specifications shall be satisfied when the capacitors are restored to 20°C after exposing them at 250°C for 30 seconds.											
	Leakage current : Less than specified value											
Diagram of Dimensions:(unit:mm)	Capacitance change : Within ±10% of initial value											
	tan δ : Less than specified value											

Multiplier for Ripple Current vs. Frequency

< 160V

CAP(µF)\Frequency(Hz)	60(50)	120	500	1K	10K	50K-100K
CAP ≤ 10	0.47	0.59	0.76	0.85	0.97	1.0
10 < CAP	0.52	0.65	0.80	0.89	0.97	1.0

≥ 160V

Frequency(Hz)	60(50)	120	400	1K	10K	50K-100K
Multiplier	0.80	1.00	1.25	1.40	1.55	1.6

Diagram of Dimensions:(unit:mm)

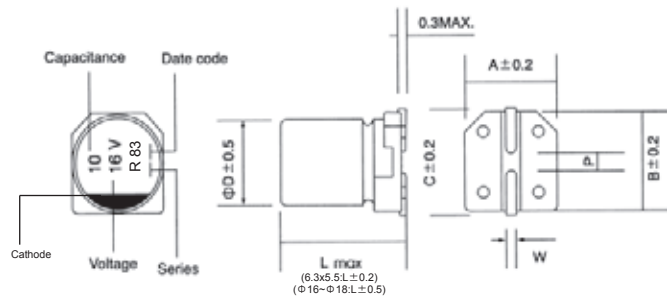

φD	L	A	B	C	W	P
4	5.5	4.3	4.3	4.9	0.5~0.8	1.0
5	5.5	5.3	5.3	5.9	0.5~0.8	1.4
6.3	5.5	6.6	6.6	7.2	0.5~0.8	2.2
6.3	6.1	6.6	6.6	7.2	0.5~0.8	2.2
6.3	7.7	6.6	6.6	7.2	0.5~0.8	2.2
8	6.5	8.3	8.3	9.0	0.5~0.8	2.3
8	10.5	8.3	8.3	9.0	0.7~1.1	3.1
10	10.5	10.3	10.3	11.0	0.7~1.1	4.5
12.5	14	13.0	13.0	13.9	1.0~1.4	4.5
16	17	17.0	17.0	18.0	1.0~1.4	6.6
16	21.5	17.0	17.0	18.0	1.0~1.4	6.6
18	16.5	19.0	19.0	20.0	1.0~1.4	6.6
18	21.5	19.0	19.0	20.0	1.0~1.4	6.6

SMD

Recommended land pattern:(unit:mm)

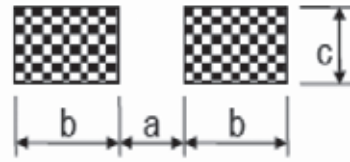

Φ DxL	a	b	c
4xall	1	2.6	1.6
5xall	1.4	3	1.6
6.3xall	2.1	3.5	1.6
8xL(height ≤6.5)	2.1	4.5	1.6
8xL(height >6.5)	2.8	4.2	1.9
10xall	4.3	4.4	1.9
12.5xall	4.3	5.8	2.5
16xall	6	6.5	3.5
18xall	6	7.5	3.5

Case Size

WV (Vdc)	Cap (uF)	Size (mm)	Ripple current (mAmps/105°C /120Hz)	Max ESR 20°C 100KHz(Ω)
6.3	22	4x5.5	80	1.35
6.3	33	4x5.5	85	1.35
6.3	47	5x5.5	160	0.80
6.3	100	6.3x5.5	240	0.44
6.3	150	6.3x5.5	240	0.44
6.3	220	6.3x7.7	280	0.36
6.3	330	6.3x7.7	350	0.32
6.3	330	8x10.5	450	0.17
6.3	470	8x10.5	500	0.17
6.3	680	8x10.5	550	0.17
6.3	1000	8x10.5	550	0.17
6.3	1500	10x10.5	690	0.09
6.3	3300	12.5x14	1150	0.066
6.3	6800	16x17	1800	0.035
10	22	4x5.5	90	1.35
10	33	5x5.5	160	0.80
10	47	6.3x5.5	230	0.44
10	100	6.3x5.5	240	0.44
10	150	6.3x5.5	250	0.44
10	220	6.3x7.7	280	0.36
10	330	8x10.5	500	0.17
10	470	8x10.5	550	0.17
10	680	10x10.5	690	0.09
10	1000	10x10.5	690	0.09
10	2200	12.5x14	1150	0.066
10	4700	16x17	1800	0.035
16	10	4x5.5	90	2.10
16	22	5x5.5	150	0.80
16	33	6.3x5.5	230	0.44
16	47	6.3x5.5	230	0.44
16	100	6.3x5.5	255	0.44
16	150	6.3x7.7	280	0.36
16	220	6.3x7.7	280	0.36
16	330	8x10.5	550	0.17
16	470	8x10.5	600	0.17
16	470	10x10.5	670	0.09
16	680	10x10.5	750	0.09
16	1500	12.5x14	1150	0.066
16	3300	16x17	1800	0.035
25	10	4x5.5	90	2.10
25	22	5x5.5	150	0.80
25	33	6.3x5.5	230	0.44
25	47	6.3x5.5	230	0.44
25	100	6.3x7.7	300	0.36
25	150	8x10.5	500	0.17
25	220	8x10.5	550	0.17
25	330	8x10.5	600	0.17

WV (Vdc)	Cap (uF)	Size (mm)	Ripple current (mAmps/105°C /120Hz)	Max ESR 20°C 100KHz(Ω)
25	470	10x10.5	670	0.09
25	1000	12.5x14	1150	0.066
25	2200	16x17	1800	0.035
35	4.7	4x5.5	90	1.90
35	10	5x5.5	150	0.80
35	22	6.3x5.5	230	0.44
35	33	6.3x5.5	230	0.44
35	47	6.3x5.5	240	0.44
35	100	8x10.5	450	0.17
35	150	8x10.5	550	0.17
35	220	8x10.5	600	0.16
35	220	10x10.5	670	0.09
35	330	10x10.5	850	0.08
35	470	12.5x14	1150	0.066
35	680	12.5x14	1150	0.066
35	1000	16x17	1800	0.066
35	1500	16x17	1800	0.066
50	1	4x5.5	60	4.40
50	2.2	4x5.5	60	3.90
50	3.3	4x5.5	60	3.90
50	4.7	4x5.5	75	3.90
50	4.7	5x5.5	85	2.10
50	10	6.3x5.5	165	1.40
50	22	6.3x5.5	165	1.20
50	33	6.3x7.7	185	0.68
50	47	6.3x7.7	185	0.68
50	68	8x10.5	300	0.34
50	100	8x10.5	350	0.34
50	100	10x10.5	555	0.25
50	150	10x10.5	555	0.25
50	220	10x10.5	600	0.23
50	470	16x17	1610	0.073
50	680	16x17	1610	0.073
50	1000	16x17	1610	0.073
63	4.7	5x5.5	50	2.60
63	10	6.3x5.5	80	1.50
63	22	6.3x7.7	120	1.00
63	33	8x10.5	250	0.70
63	47	8x10.5	280	0.65
63	68	10x10.5	400	0.38
63	100	10x10.5	420	0.24
63	100	12.5x14	540	0.22
63	150	12.5x14	800	0.18
63	220	12.5x14	830	0.16
63	470	16x17	1410	0.082
80	10	6.3x7.7	60	2.60
80	22	8x10.5	130	1.70

WV (Vdc)	Cap (uF)	Size (mm)	Ripple current (mA _{rms} /105°C /120Hz)	Max ESR 20°C 100KHz(Ω)
80	10	6.3x7.7	60	2.60
80	22	8x10.5	130	1.70
80	33	8x10.5	140	1.60
80	47	10x10.5	210	0.70
80	68	12.5x14	500	0.50
80	100	12.5x14	550	0.45
80	150	12.5x14	600	0.42
80	220	16x17	700	0.38
80	330	16x17	800	0.32
100	10	6.3x7.7	65	3.90
100	22	8x10.5	130	1.90
100	33	10x10.5	200	1.25
100	47	10x10.5	390	0.95
100	47	12.5x14	500	0.90
100	68	12.5x14	600	0.57
100	100	12.5x14	640	0.48
100	100	16x17	800	0.45

WV (Vdc)	Cap (uF)	Size (mm)	Rated Ripple current (mA _{rms} /105°C /120Hz)
160	10	8x10.5	55
160	18	10x10.5	65
160	22	10x10.5	70
160	27	12.5x14	85
160	33	12.5x14	95
160	47	16x17	260
160	68	16x17	300
200	10	12.5x14	80
200	22	12.5x14	105
200	27	12.5x14	115
200	33	16x17	220
200	47	16x17	260
250	4.7	8x10.5	50
250	4.7	12.5x14	65
250	6.8	10x10.5	60
250	6.8	12.5x14	78
250	10	10x10.5	75
250	15	12.5x14	120
250	22	16x17	180
400	2.2	8x10.5	25
400	3.3	8x10.5	30
400	3.9	10x10.5	35
400	4.7	10x10.5	40
400	6.8	12.5x14	60
400	8.2	12.5x14	65
400	10	12.5x14	70
400	12	16x17	95
400	22	16x17	120
450	3.3	10x10.5	40
450	3.9	10x10.5	40
450	4.7	12.5x14	50
450	6.8	12.5x14	60
450	8.2	12.5x14	65
450	10	12.5x14	70
450	12	16x17	90
450	15	16x17	100

TV Series High Temperature 125°C

Features

- ◆ Chip type ,operating temperature range-40 to +125°C
- ◆ Designed for surface mounting on high density PC board
- ◆ Applicable to automatic insertion machine using carrier tape
- ◆ RoHS Compliant



Specifications

Item	Performance Characteristics										
Operating Temperature Range	-40~+125°C										
Rated Voltage Range	10~100 VDC	150~450 VDC									
Capacitance Range	10 to 330 μF	1 to 18 μF									
Capacitance Tolerance	±20%(120Hz,+20°C)										
Leakage Current (+20°C,max.)	I ≤ 0.03 CV or 3 (μA) whichever is greater (1 minutes)	I ≤ 0.04 CV+100 μA (1 minute)									
Dissipation Factor (tan δ , at 20°C , 120Hz)	Working Voltage(VDC)	10 16 25 35 50 160~200 250~400 450									
	D.F.(%)max.	32 24 21 18 18 20 25 30									
Low Temperature Characteristics (at 120Hz)	Impedance ratio max										
	Working voltage(VDC)	10	16	25	35	50	160	200	250	400	450
	Z-25°C / Z+20°C	12	8	6	4	4	8	8	8	12	15
Endurance	Test condition										
	Duration time	: 1000 Hrs (Φ8X6.5mm & 6.3X7.7mm) ; 2000Hrs (Φ8X10.5mm & 10X10.5mm)									
	Ambient temperature	:+125°C									
	Applied voltage	:Rated DC working voltage									
	After test requirement at +20°C										
	Capacitance change	: Within ±30% of initial value									
	Dissipation factor	: Less than 300% of specified value									
	Leakage current	: Less than specified value									
Shelf Life	Test condition										
	Duration time	:1000 Hrs									
	Ambient temperature	:+125°C									
	Applied voltage	:None									
	After test requirement at +20°C	:Same limits as Endurance.									
	Pre-treatment for measurements shall be conducted after application of DC working voltage for 30 minutes.										
Resistance to soldering heat	The following specifications shall be satisfied when the capacitors are restored to20°C after exposing them at 250°C for 30 seconds.										
	Leakage current	Less than specified value									
	Capacitance change	Within ± 10% of initial value									
	tan δ	Less than specified value									

SMD

Multiplier for Ripple Current vs. Frequency

Frequency(Hz)	60(50)	120	500	1K	≥ 10K
0.1~47 μF	0.80	1.00	1.20	1.30	1.5
100~1000 μF	0.80	1.00	1.10	1.15	1.2

Diagram of Dimensions:(unit:mm)

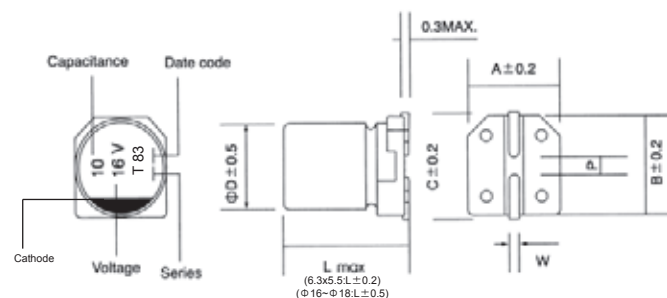

φD	L	A	B	C	W	P
4	5.5	4.3	4.3	4.9	0.5~0.8	1.0
5	5.5	5.3	5.3	5.9	0.5~0.8	1.4
6.3	5.5	6.6	6.6	7.2	0.5~0.8	2.2
6.3	6.1	6.6	6.6	7.2	0.5~0.8	2.2
6.3	7.7	6.6	6.6	7.2	0.5~0.8	2.2
8	6.5	8.3	8.3	9.0	0.5~0.8	2.3
8	10.5	8.3	8.3	9.0	0.7~1.1	3.1
10	10.5	10.3	10.3	11.0	0.7~1.1	4.5
12.5	14	13.0	13.0	13.9	1.0~1.4	4.5
16	17	17.0	17.0	18.0	1.0~1.4	6.6
16	21.5	17.0	17.0	18.0	1.0~1.4	6.6
18	16.5	19.0	19.0	20.0	1.0~1.4	6.6
18	21.5	19.0	19.0	20.0	1.0~1.4	6.6

Recommended land pattern:(unit:mm)

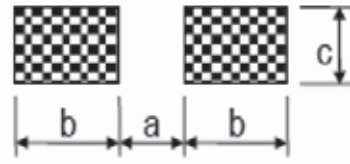

Φ DxL	a	b	c
4xall	1	2.6	1.6
5xall	1.4	3	1.6
6.3xall	2.1	3.5	1.6
8xL(height ≤6.5)	2.1	4.5	1.6
8xL(height >6.5)	2.8	4.2	1.9
10xall	4.3	4.4	1.9
12.5xall	4.3	5.8	2.5
16xall	6	6.5	3.5
18xall	6	7.5	3.5

Case Size

WV (Vdc)	Cap (uF)	Size (mm)	Rated Ripple current (mAmps/125°C /120Hz)
10	100	6.3x7.7	53
10	100	8x6.5	58
10	220	8x10.5	90
10	330	10x10.5	112
16	100	8x10.5	66
16	220	10x10.5	102
25	47	6.3x7.7	45
25	47	8x6.5	48
25	100	8x10.5	74
25	220	10x10.5	116
35	33	6.3x7.7	40
35	33	8x6.5	44
35	47	8x10.5	52
35	100	10x10.5	80
50	10	6.3x7.7	22
50	10	8x6.5	24
50	22	6.3x7.7	35
50	22	8x6.5	38
50	33	8x10.5	46
50	47	10x10.5	58

WV (Vdc)	Cap (uF)	Size (mm)	Rated Ripple current (mAmps/125°C /120Hz)
160	6.8	8x10.5	42
160	10	10x10.5	59
160	18	10x10.5	65
200	4.7	8x10.5	36
200	6.8	10x10.5	59
200	10	10x10.5	59
250	3.3	8x10.5	28
250	4.7	10x10.5	59
400	1	8x10.5	27
400	1.8	8x10.5	30
400	2.2	8x10.5	33
400	2.2	10x10.5	37
400	3.3	8x10.5	36
400	3.3	10x10.5	39
400	4.7	10x10.5	46
400	5.6	10x10.5	50
450	2.2	8x10.5	28
450	3.3	10x10.5	32
450	3.9	10x10.5	38

SS Series 5 mm 85°C

Features

- ◆ Design for space-saving and high density insertion.
- ◆ 4WV products are standardized for recent battery power source devices.
- ◆ Low price compared to Tantalum capacitors.
- ◆ Applications: VTR, car radio and commercial applications.
- ◆ RoHS Compliant



Specifications

Item	Performance Characteristics
Operating Temperature Range	-40 to +85°C
Rated Voltage Range	4 to 50 VDC
Capacitance Range	0.1 to 330 µF
Capacitance Tolerance	±20% (120Hz, +20°C)
Leakage Current(+20°C, max)	I ≤ 0.01 CV or 3 (µA) After 1 minute, whichever is greater measured with rated working voltage applied.
Dissipation Factor (tan δ, at 20°C, 120Hz)	Rated Voltage(VDC) 4 6.3 10 16 25 35 50
	D.F. (%)max. 35 24 20 16 14 12 10
Low Temperature Characteristics (at 120Hz)	Impedance ratio max
	Rated Voltage(VDC) 4 6.3 10 16 25 35 50
	Z-25°C/Z+20°C 7 4 3 2 2 2 2
	Z-40°C/Z+20°C 15 8 8 4 4 3 3
Endurance	Test conditions
	Duration time :1000 Hrs
	Ambient temperature :+85°C
	Applied voltage :Rated DC working voltage
	After test requirement at +20°C
	Capacitance change : ≤ ±20% of the initial measured value (4V : ≤ ±30%)
Dissipation factor : ≤ 200% of the initial specified value	
Leakage current : ≤ The initial specified value	
Shelf Life	Test conditions
	Duration time :1000 Hrs
	Ambient temperature :+85°C
	Applied voltage :None
	After test requirement at +20°C : Same limits as Endurance. Pre-treatment for measurements shall be conducted after application of DC working voltage for 30 minutes.

Radial

Multiplier for Ripple Current vs. Frequency

Frequency(Hz) \ CAP(µF)	50(60)	120	1K	≥10K
0.1~68 µF	0.8	1	1.30	1.5
100~330 µF	0.8	1	1.15	1.2

Diagram of Dimensions:(unit:mm)

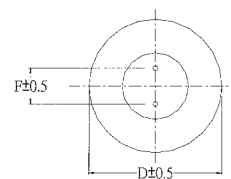
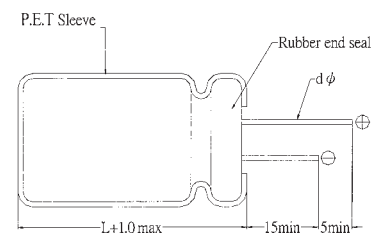

D φ	4	5	6.3	8
F	1.5±0.5	2.0±0.5	2.5±0.5	3.5±0.5
d φ	0.45			

Case Size

WV (Vdc)	Cap (uF)	Size (mm)	Rated Ripple current (mA rms/85°C /120Hz)
4	10	4x5	11
4	15	4x5	17
4	22	4x5	21
4	33	4x5	28
4	47	4x5	33
4	68	5x5	43
4	68	6.3x5	48
4	100	5x5	52
4	220	6.3x5	78
4	330	8x5	142
6.3	10	4x5	14
6.3	15	4x5	17
6.3	22	4x5	24
6.3	33	4x5	33
6.3	33	5x5	37
6.3	47	5x5	39
6.3	68	6.3x5	53
6.3	100	6.3x5	65
6.3	220	6.3x5	90
6.3	220	8x5	115
6.3	330	8x5	145
10	6.8	4x5	11
10	10	4x5	17
10	15	4x5	21
10	22	4x5	30
10	22	5x5	33
10	33	5x5	39
10	47	5x5	42
10	47	6.3x5	46
10	68	6.3x5	56
10	100	6.3x5	76
10	220	8x5	138
16	4.7	4x5	11
16	6.8	4x5	13
16	10	4x5	20
16	15	5x5	26
16	22	4x5	33
16	22	5x5	35
16	33	5x5	42
16	33	6.3x5	46
16	47	6.3x5	58

WV (Vdc)	Cap (uF)	Size (mm)	Rated Ripple current (mA rms/85°C /120Hz)
16	68	6.3x5	65
16	100	6.3x5	86
16	100	8x5	92
25	3.3	4x5	10
25	4.7	4x5	15
25	6.8	4x5	17
25	10	4x5	27
25	10	5x5	28
25	15	5x5	30
25	15	6.3x5	33
25	22	6.3x5	44
25	33	6.3x5	52
25	47	6.3x5	62
25	68	8x5	90
25	100	8x5	108
35	2.2	4x5	8
35	3.3	4x5	11
35	4.7	4x5	18
35	6.8	5x5	20
35	10	5x5	29
35	15	6.3x5	33
35	22	6.3x5	46
35	33	8x5	63
35	47	8x5	83
50	0.1	4x5	2
50	0.15	4x5	2
50	0.22	4x5	3
50	0.33	4x5	3
50	0.47	4x5	4
50	0.68	4x5	5
50	1	4x5	6
50	1.5	4x5	7
50	2.2	4x5	9
50	3.3	4x5	14
50	4.7	5x5	20
50	6.8	6.3x5	25
50	10	6.3x5	30
50	15	6.3x5	37
50	22	6.3x5	48
50	22	8x5	52
50	33	8x5	70

ST Series 5 mm 105°C

Features

- ◆ 5.0±1 mm max height
- ◆ Endurance 105°C, 1000 hrs assured
- ◆ RoHS Compliant



Specifications

Item	Performance Characteristics
Operating Temperature Range	-40 to +105°C
Rated Voltage Range	4 to 50 VDC
Capacitance Range	0.1 to 220 μF
Capacitance Tolerance	±20% (120Hz, +20°C)
Leakage Current(+20°C, max)	I ≤ 0.01 CV or 3 (μA) After 2 minute, whichever is greater measured with rated working voltage applied.
Dissipation Factor (tan δ, at 20°C, 120Hz)	Rated Voltage(VDC)
	D.F. (%)max.
Low Temperature Characteristics (at 120Hz)	Impedance ratio max
	Rated Voltage(VDC)
	Z-25°C/Z+20°C
Endurance	Test conditions
	Duration time
	Ambient temperature
	Applied voltage
	After test requirement at +20°C
	Capacitance change
Shelf Life	Test conditions
	Duration time
	Ambient temperature
	Applied voltage
	After test requirement at +20°C
	Pre-treatment for measurements shall be conducted after application of DC working voltage for 30 minutes.

Radial

Multiplier for Ripple Current vs. Frequency

Frequency(Hz) \ CAP(μF)	50(60)	120	1K	≥10K
0.1~47 μF	0.8	1	1.30	1.5
100~220 μF	0.8	1	1.15	1.2

Diagram of Dimensions:(unit:mm)

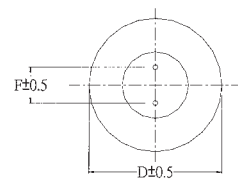
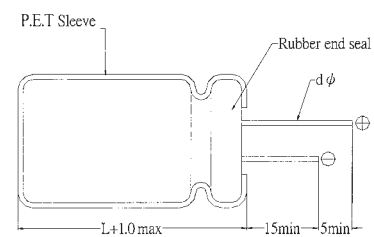

D φ	4	5	6.3	8
F	1.5±0.5	2.0±0.5	2.5±0.5	3.5±0.5
d φ	0.45			

Case Size

WV (Vdc)	Cap (uF)	Size (mm)	Rated Ripple current (mA _{rms} /105°C /120Hz)
4	10	4x5	10
4	15	4x5	13
4	22	4x5	22
4	33	5x5	30
4	47	5x5	36
4	68	6.3x5	52
4	100	6.3x5	60
4	220	6.3x5	80
6.3	10	4x5	12
6.3	15	4x5	15
6.3	22	4x5	22
6.3	33	5x5	30
6.3	47	5x5	36
6.3	68	6.3x5	52
6.3	100	6.3x5	60
6.3	220	6.3x5	80
10	6.8	4x5	11
10	10	4x5	15
10	15	4x5	18
10	22	5x5	27
10	33	5x5	35
10	47	6.3x5	48
10	68	6.3x5	53
10	100	8x5	65
10	220	8x5	83
16	4.7	4x5	9
16	6.8	4x5	13
16	10	4x5	18
16	15	5x5	23
16	22	5x5	30
16	33	6.3x5	45
16	47	6.3x5	50
16	68	8x5	55
16	100	8x5	68

WV (Vdc)	Cap (uF)	Size (mm)	Rated Ripple current (mA _{rms} /105°C /120Hz)
25	3.3	4x5	9
25	4.7	4x5	13
25	6.8	4x5	15
25	10	5x5	23
25	15	6.3x5	32
25	22	6.3x5	39
25	33	6.3x5	48
25	47	6.3x5	50
25	47	8x5	55
35	2.2	4x5	8
35	3.3	4x5	11
35	4.7	4x5	15
35	6.8	5x5	19
35	10	5x5	25
35	15	6.3x5	32
35	22	6.3x5	48
35	33	8x5	50
50	0.1	4x5	2
50	0.15	4x5	2
50	0.22	4x5	3
50	0.33	4x5	3
50	0.47	4x5	4
50	0.68	4x5	5
50	1	4x5	6
50	1.5	4x5	7
50	2.2	4x5	11
50	3.3	4x5	14
50	4.7	5x5	19
50	6.8	5x5	22
50	6.8	6.3x5	25
50	10	6.3x5	30
50	15	8x5	35
50	22	8x5	50

SA Series 5 mm, Low Leakage Current 85°C



Features

- ◆ Low leakage current, height 5 mm
- ◆ RoHS Compliant

Specifications

Item	Performance Characteristics
Operating Temperature Range	-40 to +85°C
Rated Voltage Range	4 to 50 VDC
Capacitance Range	0.1 to 100 μF
Capacitance Tolerance	±20% (120Hz, +20°C)
Leakage Current(+20°C, max)	I ≤ 0.002 CV or 0.4 (μA) After 2 minute, whichever is greater measured with rated working voltage applied.
Dissipation Factor (tan δ, at 20°C, 120Hz)	Rated Voltage(VDC)
	D.F. (%)max.
Low Temperature Characteristics (at 120Hz)	Impedance ratio max
	Z-40°C/Z+20°C
Endurance	Test conditions
	After test requirement at +20°C
Shelf Life	Test conditions
	After test requirement at +20°C

Radial

Multiplier for Ripple Current vs. Frequency

Frequency(Hz) \ CAP(μF)	50(60)	120	1K	≥10K
0.1~47 μF	0.8	1	1.30	1.5
100 μF	0.8	1	1.15	1.2

Diagram of Dimensions:(unit:mm)

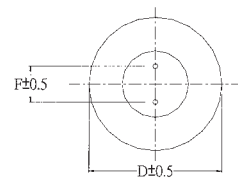
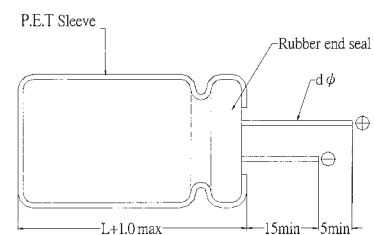

D φ	4	5	6.3	8
F	1.5±0.5	2.0±0.5	2.5±0.5	3.5±0.5
d φ	0.45			

Case Size

WV (Vdc)	Cap (uF)	Size (mm)	Rated Ripple current (mArms/85°C /120Hz)
4	33	5x5	28
4	47	5x5	33
4	100	6.3x5	56
6.3	22	4x5	28
6.3	33	5x5	37
6.3	47	5x5	45
6.3	100	6.3x5	70
10	22	4x5	32
10	33	5x5	41
10	47	6.3x5	52
16	10	4x5	25
16	22	5x5	37
16	33	6.3x5	49
16	47	6.3x5	58
25	4.7	4x5	16
25	10	5x5	27
25	22	6.3x5	42
25	33	6.3x5	52
35	4.7	4x5	18
35	10	5x5	29
35	22	6.3x5	46
50	0.1	4x5	1
50	0.22	4x5	2
50	0.33	4x5	3
50	0.47	4x5	4
50	1	4x5	8
50	2.2	4x5	13
50	3.3	5x5	17
50	4.7	5x5	20
50	10	6.3x5	33
50	22	8x5	60

SP Series 5 mm, Non-polar 85°C



Features

- ◆ Non-polarized with 5 mm for crossover networks of height-pitched, mean and low pitched sounds in high-fidelity sound systems.
- ◆ The series offers excellent frequency characteristics and minimal capacitance deviation with frequency.
- ◆ RoHS Compliant

Specifications

Item	Performance Characteristics
Operating Temperature Range	-40 to +85°C
Rated Voltage Range	6.3 to 50 VDC
Capacitance Range	0.1 to 47 μF
Capacitance Tolerance	±20% (120Hz, +20°C)
Leakage Current(+20°C, max)	I ≤ 0.05 CV or 10 (μA) After 2 minute, whichever is greater measured with rated working voltage applied.
Dissipation Factor (tan δ, at 20°C, 120Hz)	Rated Voltage(VDC)
	D.F. (%)max.
Low Temperature Characteristics (at 120Hz)	Impedance ratio max
	Rated Voltage(VDC)
	Z-25°C/Z+20°C
	Z-40°C/Z+20°C
Endurance	Test conditions
	Duration time
	Ambient temperature
	Applied voltage
	After test requirement at +20°C
	Capacitance change
	Dissipation factor
Leakage current	
Shelf Life	Test conditions
	Duration time
	Ambient temperature
	Applied voltage
After test requirement at +20°C : Same limits as Endurance. Pre-treatment for measurements shall be conducted after application of DC working voltage for 30 minutes.	

Radial

Multiplier for Ripple Current vs. Frequency

Frequency(Hz) \ CAP(μF)	50(60)	120	400	1K	10K	50K-100K
CAP ≤ 10	0.80	1.00	1.30	1.45	1.65	1.7
10 < CAP ≤ 100	0.80	1.00	1.23	1.36	1.48	1.53
100 < CAP ≤ 1000	0.80	1.00	1.16	1.25	1.35	1.38

Diagram of Dimensions:(unit:mm)

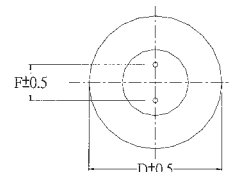
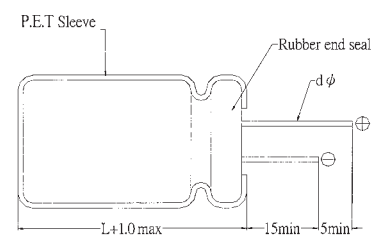

D φ	4	5	6.3
F	1.5±0.5	2.0±0.5	2.5±0.5
d φ	0.45		

Case Size

WV (Vdc)	Cap (uF)	Size (mm)	Rated Ripple current (mA rms/85°C /120Hz)
6.3	10	4x5	15
6.3	22	5x5	27
6.3	33	6.3x5	35
6.3	47	6.3x5	44
10	10	4x5	16
10	10	5x5	18
10	22	6.3x5	32
10	33	6.3x5	40
16	3.3	4x5	10
16	4.7	4x5	12
16	10	5x5	23
16	22	6.3x5	36
16	33	6.3x5	47
25	3.3	5x5	13
25	4.7	5x5	15
25	10	6.3x5	25
35	2.2	4x5	9
35	3.3	5x5	14
35	4.7	5x5	16
35	10	6.3x5	28
50	0.1	4x5	1
50	0.22	4x5	2
50	0.33	4x5	3
50	0.47	4x5	4
50	1	4x5	8
50	2.2	5x5	13
50	3.3	5x5	15
50	4.7	6.3x5	18

SM Series 7 mm 85°C Standard



Features

- ◆ Design for space-saving and high density insertion.
- ◆ Applications: VTR, car radio, car stereos, charger, etc.
- ◆ RoHS Compliant

Specifications

Item	Performance Characteristics								
Operating Temperature Range	-40 to +85°C								
Rated Voltage Range	4 to 63 VDC								
Capacitance Range	0.1 to 470 μF								
Capacitance Tolerance	±20% (120Hz, +20°C)								
Leakage Current(+20°C, max)	I ≤ 0.01 CV or 3 (μA) After 1 minute, whichever is greater measured with rated working voltage applied.								
Dissipation Factor (tan δ, at 20°C, 120Hz)	Rated Voltage(VDC)	4	6.3	10	16	25	35	50	63
	D.F. (%)max.	25	22	20	16	14	12	10	9
Low Temperature Characteristics (at 120Hz)	Impedance ratio max								
	Rated Voltage(VDC)	4	6.3	10	16	25	35	50	63
	Z-25°C / Z+20°C	7	4	3	2	2	2	2	2
	Z-40°C / Z+20°C	15	8	6	4	4	3	3	3
Endurance	Test conditions								
	Duration time	:1000 Hrs							
	Ambient temperature	:+85°C							
	Applied voltage	:Rated DC working voltage							
	After test requirement at +20°C								
	Capacitance change	: ≤ ±20% of the initial measured value (4V : ≤ ±30%)							
Dissipation factor	: ≤ 200% of the initial specified value								
Leakage current	: ≤ The initial specified value								
Shelf Life	Test conditions								
	Duration time	:1000 Hrs							
	Ambient temperature	:+85°C							
Applied voltage	:None								
After test requirement at +20°C : Same limits as Endurance.									
Pre-treatment for measurements shall be conducted after application of DC working voltage for 30 minutes.									

Radial

Multiplier for Ripple Current vs. Frequency

Frequency(Hz) \ CAP(μF)	50(60)	120	400	1K	10K	50K-100K
CAP ≤ 10	0.80	1.00	1.30	1.45	1.65	1.7
10 < CAP ≤ 100	0.80	1.00	1.23	1.36	1.48	1.53
100 < CAP ≤ 1000	0.80	1.00	1.16	1.25	1.35	1.38

Diagram of Dimensions:(unit:mm)

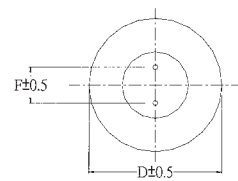
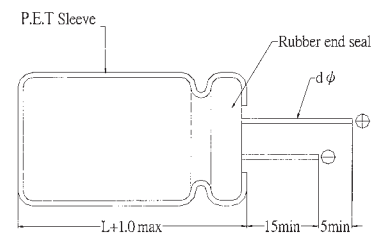

D φ	4	5	6.3	8
F	1.5±0.5	2.0±0.5	2.5±0.5	3.5±0.5
d φ	0.45		0.5	

Case Size

WV (Vdc)	Cap (uF)	Size (mm)	Rated Ripple current (mA _{rms} /85°C /120Hz)
4	33	4x7	33
4	47	4x7	35
4	68	4x7	42
4	100	4x7	55
4	100	5x7	61
4	150	5x7	72
4	220	6.3x7	110
4	330	6.3x7	120
4	330	8x7	165
4	470	8x7	235
6.3	15	4x7	28
6.3	22	4x7	35
6.3	33	4x7	40
6.3	33	5x7	42
6.3	47	4x7	46
6.3	47	5x7	48
6.3	68	5x7	50
6.3	100	5x7	75
6.3	100	6.3x7	80
6.3	150	6.3x7	82
6.3	150	8x7	85
6.3	220	6.3x7	120
6.3	220	8x7	133
6.3	330	8x7	160
10	15	4x7	32
10	22	4x7	36
10	22	5x7	38
10	33	4x7	43
10	33	5x7	45
10	47	4x7	50
10	47	5x7	58
10	68	5x7	60
10	100	5x7	82
10	100	6.3x7	90
10	150	6.3x7	95
10	220	6.3x7	136
10	220	8x7	140
10	330	8x7	182
16	4.7	4x7	15
16	6.8	4x7	20
16	10	4x7	28
16	15	4x7	35
16	22	4x7	40
16	22	5x7	42
16	33	4x7	45
16	33	5x7	55
16	47	5x7	65
16	47	6.3x7	68
16	68	6.3x7	70
16	100	6.3x7	98
16	100	8x7	105
16	150	8x7	111
16	220	8x7	152
25	4.7	4x7	20
25	6.8	4x7	22
25	10	4x7	30
25	15	5x7	37

WV (Vdc)	Cap (uF)	Size (mm)	Rated Ripple current (mA _{rms} /85°C /120Hz)
25	22	4x7	46
25	22	5x7	50
25	33	5x7	52
25	33	6.3x7	58
25	47	6.3x7	71
25	68	6.3x7	79
25	100	8x7	113
35	3.3	4x7	18
35	4.7	4x7	22
35	6.8	5x7	25
35	10	4x7	31
35	10	5x7	33
35	15	5x7	37
35	22	5x7	47
35	22	6.3x7	55
35	33	6.3x7	65
35	33	8x7	68
35	47	8x7	85
35	68	8x7	88
35	100	8x7	119
50	0.1	4x7	1
50	0.15	4x7	2
50	0.22	4x7	3
50	0.33	4x7	4
50	0.47	4x7	5
50	0.68	4x7	8
50	1	4x7	10
50	1.5	4x7	13
50	2.2	4x7	17
50	3.3	4x7	23
50	4.7	4x7	24
50	4.7	5x7	26
50	6.8	5x7	28
50	10	5x7	35
50	10	6.3x7	38
50	15	6.3x7	42
50	22	6.3x7	59
50	22	8x7	63
50	33	8x7	75
50	47	8x7	88
63	0.1	4x7	1
63	0.15	4x7	2
63	0.22	4x7	3
63	0.33	4x7	4
63	0.47	4x7	6
63	0.68	4x7	8
63	1	4x7	12
63	1.5	4x7	14
63	2.2	4x7	18
63	3.3	5x7	25
63	4.7	5x7	30
63	4.7	6.3x7	33
63	6.8	6.3x7	31
63	10	6.3x7	48
63	15	8x7	45
63	22	8x7	65

SH Series 7 mm 85°C Long Life

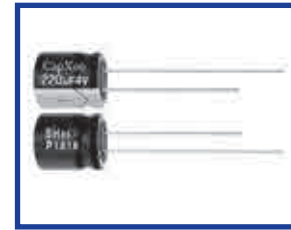

Features

- ◆ Long life 2000 hrs.
- ◆ Design for space-saving and high density insertion.
- ◆ Applications: VTR, car radio, car stereos, charger, etc.
- ◆ RoHS Compliant

Specifications

Item	Performance Characteristics
Operating Temperature Range	-40 to +85°C
Rated Voltage Range	4 to 63 VDC
Capacitance Range	0.1 to 470 µF
Capacitance Tolerance	±20% (120Hz, +20°C)
Leakage Current(+20°C, max)	I ≤ 0.01 CV or 3 (µA) After 1 minute, whichever is greater measured with rated working voltage applied.
Dissipation Factor (tan δ, at 20°C, 120Hz)	Rated Voltage(VDC) 4 6.3 10 16 25 35 50 63
	D.F. (%)max. 25 22 20 16 14 12 10 9
Low Temperature Characteristics (at 120Hz)	Impedance ratio max
	Rated Voltage(VDC) 4 6.3 10 16 25 35 50 63
	Z-25°C / Z+20°C 7 4 3 2 2 2 2 2
Z-40°C / Z+20°C	15 8 6 4 4 3 3 3
	Endurance
Shelf Life	Test conditions Duration time :1000 Hrs Ambient temperature :+85°C Applied voltage :None After test requirement at +20°C : Same limits as Endurance. Pre-treatment for measurements shall be conducted after application of DC working voltage for 30 minutes.

Radial

Multiplier for Ripple Current vs. Frequency

Frequency(Hz) \ CAP(µF)	50(60)	120	400	1K	10K	50K-100K
CAP ≤ 10	0.80	1.00	1.30	1.45	1.65	1.7
10 < CAP ≤ 100	0.80	1.00	1.23	1.36	1.48	1.53
100 < CAP ≤ 1000	0.80	1.00	1.16	1.25	1.35	1.38

Diagram of Dimensions:(unit:mm)

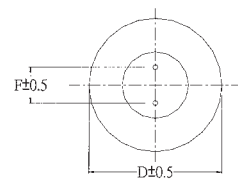
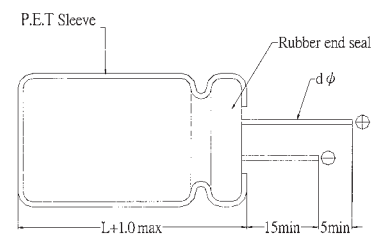

D φ	4	5	6.3	8
F	1.5±0.5	2.0±0.5	2.5±0.5	3.5±0.5
d φ	0.45		0.5	

Case Size

WV (Vdc)	Cap (uF)	Size (mm)	Rated Ripple current (mA rms/85°C /120Hz)
4	22	4x7	23
4	33	4x7	26
4	47	4x7	35
4	68	5x7	55
4	100	5x7	58
4	220	6.3x7	65
4	330	6.3x7	90
4	470	8x7	120
6.3	22	4x7	31
6.3	33	4x7	32
6.3	33	5x7	35
6.3	47	4x7	40
6.3	47	5x7	47
6.3	68	5x7	55
6.3	100	5x7	65
6.3	100	6.3x7	75
6.3	220	6.3x7	70
6.3	220	8x7	90
6.3	330	8x7	120
10	15	4x7	28
10	22	4x7	35
10	33	4x7	40
10	33	5x7	45
10	47	4x7	47
10	47	5x7	51
10	68	5x7	60
10	68	6.3x7	68
10	100	5x7	80
10	100	6.3x7	90
10	220	6.3x7	105
10	220	8x7	125
16	6.8	4x7	20
16	10	4x7	30
16	15	4x7	32
16	22	4x7	37
16	22	5x7	42
16	33	4x7	45
16	33	5x7	50
16	47	5x7	61
16	47	6.3x7	67
16	68	6.3x7	72
16	100	6.3x7	95
16	100	8x7	105
25	4.7	4x7	17
25	6.8	4x7	21
25	10	4x7	30
25	10	5x7	33
25	15	5x7	38
25	22	5x7	45
25	22	6.3x7	48
25	33	5x7	52
25	33	6.3x7	60
25	47	6.3x7	68

WV (Vdc)	Cap (uF)	Size (mm)	Rated Ripple current (mA rms/85°C /120Hz)
25	47	8x7	72
25	68	6.3x7	75
25	100	8x7	115
35	4.7	4x7	22
35	6.8	4x7	24
35	6.8	5x7	28
35	10	4x7	30
35	10	5x7	35
35	15	5x7	38
35	15	6.3x7	45
35	22	5x7	50
35	22	6.3x7	58
35	33	6.3x7	54
35	33	8x7	68
35	47	8x7	80
35	68	8x7	85
50	0.1	4x7	2
50	0.15	4x7	2
50	0.22	4x7	3
50	0.33	4x7	4
50	0.47	4x7	5
50	0.68	4x7	7
50	1	4x7	10
50	1.5	4x7	13
50	2.2	4x7	19
50	3.3	4x7	24
50	4.7	4x7	27
50	4.7	5x7	29
50	6.8	5x7	32
50	6.8	6.3x7	33
50	10	5x7	35
50	10	6.3x7	38
50	15	6.3x7	52
50	22	6.3x7	60
50	22	8x7	63
50	33	8x7	78
63	0.1	4x7	2
63	0.15	4x7	2
63	0.22	4x7	3
63	0.33	4x7	4
63	0.47	4x7	6
63	0.68	4x7	7
63	1	4x7	12
63	1.5	4x7	14
63	2.2	4x7	19
63	3.3	5x7	25
63	4.7	5x7	29
63	4.7	6.3x7	33
63	6.8	6.3x7	35
63	10	6.3x7	40
63	15	8x7	55
63	22	8x7	65

SK Series 7 mm Standard 105°C



Features

- ◆ Design for space-saving and high density insertion.
- ◆ Applications: VTR, car radio, car stereos. charger, etc.
- ◆ RoHS Compliant

Specifications

Item	Performance Characteristics								
Operating Temperature Range	-40 to +105°C								
Rated Voltage Range	4 to 63 VDC								
Capacitance Range	0.1 to 470 μF								
Capacitance Tolerance	±20% (120Hz, +20°C)								
Leakage Current(+20°C, max)	I ≤ 0.01 CV or 3 (μA) After 1 minute, whichever is greater measured with rated working voltage applied.								
Dissipation Factor (tan δ, at 20°C, 120Hz)	Rated Voltage(VDC)	4	6.3	10	16	25	35	50	63
	D.F. (%)max.	25	22	20	16	14	12	10	9
Low Temperature Characteristics (at 120Hz)	Impedance ratio max								
	Rated Voltage(VDC)	4	6.3	10	16	25	35	50	63
	Z-25°C / Z+20°C	7	4	3	2	2	2	2	2
	Z-40°C / Z+20°C	15	8	6	4	4	3	3	3
Endurance	Test conditions								
	Duration time	:1000 Hrs							
	Ambient temperature	:+105°C							
	Applied voltage	:Rated DC working voltage							
	After test requirement at +20°C								
	Capacitance change	: ≤ ±20% of the initial measured value (4V : ≤ ±30%)							
Dissipation factor	: ≤ 200% of the initial specified value								
Leakage current	: ≤ The initial specified value								
Shelf Life	Test conditions								
	Duration time	:1000 Hrs							
	Ambient temperature	:+105°C							
Applied voltage	:None								
After test requirement at +20°C : Same limits as Endurance.									
Pre-treatment for measurements shall be conducted after application of DC working voltage for 30 minutes.									

Radial

Multiplier for Ripple Current vs. Frequency

Frequency(Hz) \ CAP(μF)	50(60)	120	400	1K	10K	50K-100K
CAP ≤ 10	0.80	1.00	1.30	1.45	1.65	1.7
10 < CAP ≤ 100	0.80	1.00	1.23	1.36	1.48	1.53
100 < CAP ≤ 1000	0.80	1.00	1.16	1.25	1.35	1.38

Diagram of Dimensions:(unit:mm)

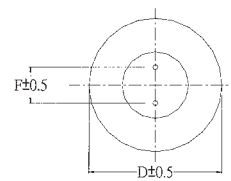
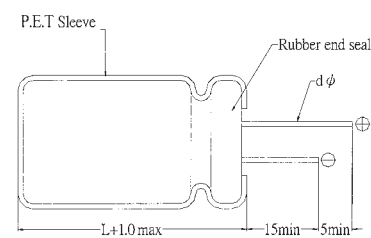

Dφ	4	5	6.3	8
F	1.5±0.5	2.0±0.5	2.5±0.5	3.5±0.5
dφ	0.45		0.5	

Case Size

WV (Vdc)	Cap (uF)	Size (mm)	Rated Ripple current (mAmps/105°C /120Hz)
4	22	4x7	23
4	33	4x7	26
4	47	4x7	35
4	68	5x7	55
4	100	5x7	58
4	220	6.3x7	65
4	330	6.3x7	90
4	470	8x7	120
6.3	22	4x7	31
6.3	33	4x7	32
6.3	33	5x7	35
6.3	47	4x7	40
6.3	47	5x7	47
6.3	68	5x7	55
6.3	100	5x7	65
6.3	100	6.3x7	75
6.3	220	6.3x7	90
6.3	220	8x7	120
6.3	330	8x7	120
10	15	4x7	28
10	22	4x7	35
10	33	4x7	40
10	33	5x7	45
10	47	4x7	47
10	47	5x7	51
10	68	5x7	60
10	68	6.3x7	68
10	100	5x7	80
10	100	6.3x7	90
10	220	6.3x7	105
10	220	8x7	150
16	6.8	4x7	20
16	10	4x7	30
16	15	4x7	32
16	22	4x7	37
16	22	5x7	42
16	33	4x7	45
16	33	5x7	50
16	47	5x7	61
16	47	6.3x7	67
16	68	6.3x7	72
16	100	6.3x7	95
16	100	8x7	105
25	4.7	4x7	17
25	6.8	4x7	21
25	10	4x7	30
25	10	5x7	33
25	15	5x7	38
25	22	5x7	45
25	22	6.3x7	48
25	33	5x7	52
25	33	6.3x7	60
25	47	6.3x7	68

WV (Vdc)	Cap (uF)	Size (mm)	Rated Ripple current (mAmps/105°C /120Hz)
25	47	8x7	72
25	68	6.3x7	75
25	100	8x7	115
35	4.7	4x7	22
35	6.8	4x7	24
35	6.8	5x7	28
35	10	4x7	30
35	10	5x7	35
35	15	5x7	38
35	15	6.3x7	45
35	22	5x7	50
35	22	6.3x7	58
35	33	6.3x7	54
35	33	8x7	68
35	47	8x7	80
35	68	8x7	85
50	0.1	4x7	2
50	0.15	4x7	2
50	0.22	4x7	3
50	0.33	4x7	4
50	0.47	4x7	5
50	0.68	4x7	7
50	1	4x7	10
50	1.5	4x7	13
50	2.2	4x7	19
50	3.3	4x7	24
50	4.7	4x7	27
50	4.7	5x7	29
50	6.8	5x7	32
50	6.8	6.3x7	33
50	10	5x7	35
50	10	6.3x7	38
50	15	6.3x7	52
50	22	6.3x7	60
50	22	8x7	63
50	33	8x7	78
63	0.1	4x7	2
63	0.15	4x7	2
63	0.22	4x7	3
63	0.33	4x7	4
63	0.47	4x7	6
63	0.68	4x7	7
63	1	4x7	12
63	1.5	4x7	14
63	2.2	4x7	19
63	3.3	5x7	25
63	4.7	5x7	29
63	4.7	6.3x7	33
63	6.8	6.3x7	35
63	10	6.3x7	40
63	15	8x7	55
63	22	8x7	65

SJ Series 7 mm 105°C Long Life



Features

- ◆ Design for space-saving and high density insertion.
- ◆ Applications: VTR, car radio, car stereos, charger, etc.
- ◆ RoHS Compliant

Specifications

Item	Performance Characteristics
Operating Temperature Range	-40 to +105°C
Rated Voltage Range	6.3 to 63 VDC
Capacitance Range	0.1 to 220 μF
Capacitance Tolerance	±20% (120Hz, +20°C)
Leakage Current(+20°C, max)	I ≤ 0.01 CV or 3 (μA) After 1 minute, whichever is greater measured with rated working voltage applied.
Dissipation Factor (tan δ, at 20°C, 120Hz)	Rated Voltage(VDC)
	D.F. (%)max.
Low Temperature Characteristics (at 120Hz)	Impedance ratio max
	Rated Voltage(VDC)
	Z-25°C / Z+20°C
Endurance	Test conditions
	Duration time
	Ambient temperature
	Applied voltage
	After test requirement at +20°C
	Capacitance change
Shelf Life	Test conditions
	Duration time
	Ambient temperature
	Applied voltage
	After test requirement at +20°C
	Pre-treatment for measurements shall be conducted after application of DC working voltage for 30 minutes.

Radial

Multiplier for Ripple Current vs. Frequency

Frequency(Hz) \ CAP(μF)	50(60)	120	400	1K	10K	50K-100K
CAP ≤ 10	0.80	1.00	1.30	1.45	1.65	1.7
10 < CAP ≤ 220	0.80	1.00	1.23	1.36	1.48	1.53

Diagram of Dimensions:(unit:mm)

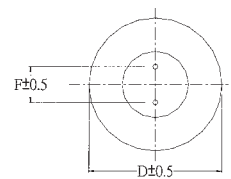
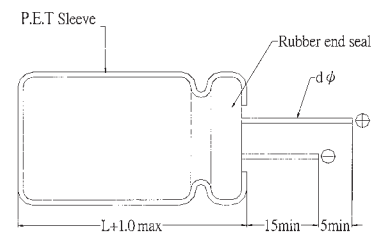

D φ	4	5	6.3	8
F	1.5±0.5	2.0±0.5	2.5±0.5	3.5±0.5
d φ	0.45		0.5	

Case Size

WV (Vdc)	Cap (uF)	Size (mm)	Rated Ripple current (mAmps/105°C /120Hz)
6.3	22	4x7	28
6.3	33	4x7	32
6.3	33	5x7	35
6.3	47	5x7	47
6.3	68	5x7	50
6.3	100	6.3x7	75
6.3	220	8x7	92
10	15	4x7	26
10	22	4x7	32
10	33	5x7	48
10	47	5x7	51
10	68	6.3x7	68
10	100	6.3x7	80
10	100	8x7	95
10	220	8x7	130
16	6.8	4x7	19
16	10	4x7	28
16	15	4x7	30
16	22	4x7	35
16	22	5x7	42
16	33	5x7	50
16	47	6.3x7	67
16	68	6.3x7	70
16	68	8x7	78
16	100	8x7	110
25	4.7	4x7	17
25	6.8	4x7	19
25	10	4x7	28
25	10	5x7	33
25	15	5x7	35
25	22	5x7	43
25	22	6.3x7	45
25	33	6.3x7	62
25	47	8x7	75
25	68	8x7	80
25	100	8x7	115
35	4.7	4x7	22
35	6.8	4x7	24
35	6.8	5x7	28
35	10	5x7	35
35	15	5x7	38

WV (Vdc)	Cap (uF)	Size (mm)	Rated Ripple current (mAmps/105°C /120Hz)
35	15	6.3x7	45
35	22	6.3x7	60
35	33	6.3x7	50
35	33	8x7	68
35	47	8x7	80
35	68	8x7	85
50	0.1	4x7	2
50	0.15	4x7	2
50	0.22	4x7	3
50	0.33	4x7	4
50	0.47	4x7	5
50	0.68	4x7	7
50	1	4x7	10
50	1.5	4x7	13
50	2.2	4x7	20
50	3.3	4x7	26
50	4.7	4x7	27
50	4.7	5x7	29
50	6.8	5x7	32
50	6.8	6.3x7	33
50	10	6.3x7	38
50	15	6.3x7	52
50	22	8x7	63
50	33	8x7	78
63	0.1	4x7	2
63	0.15	4x7	2
63	0.22	4x7	3
63	0.33	4x7	4
63	0.47	4x7	6
63	0.68	4x7	7
63	1	4x7	12
63	1.5	4x7	14
63	2.2	4x7	20
63	3.3	5x7	28
63	4.7	5x7	29
63	4.7	6.3x7	33
63	6.8	6.3x7	35
63	10	6.3x7	40
63	15	8x7	55
63	22	8x7	65

SG Series 7~9mm Long life

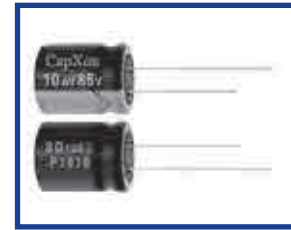

Features

- ◆ Operating temperature -40~105°C.
- ◆ 105°C 4000Hours assured.
- ◆ 7~9mm Height

Specifications

Item	Performance Characteristics																					
Operating Temperature Range	-40 to +105°C																					
Rated Voltage Range	6.3 to 50 VDC																					
Capacitance Range	0.1 to 470 µF																					
Capacitance Tolerance	±20%(120Hz,+20°C)																					
Leakage Current (+20°C,max.)	$I \leq 0.01 \text{ CV or } 3 (\mu\text{A})$ After 2 minute with rated working voltage applied.																					
Dissipation Factor ($\tan \delta$, at 20°C , 120Hz)	<table border="1"> <tr> <td>Working Voltage(VDC)</td> <td>6.3</td> <td>10</td> <td>16</td> <td>25</td> <td>35</td> <td>50</td> </tr> <tr> <td>D.F.(%)max.</td> <td>24</td> <td>20</td> <td>17</td> <td>15</td> <td>13</td> <td>12</td> </tr> </table>	Working Voltage(VDC)	6.3	10	16	25	35	50	D.F.(%)max.	24	20	17	15	13	12							
	Working Voltage(VDC)	6.3	10	16	25	35	50															
D.F.(%)max.	24	20	17	15	13	12																
Low Temperature Characteristics (at 120Hz)	Impedance ratio max																					
	<table border="1"> <tr> <td>Working Voltage(VDC)</td> <td>6.3</td> <td>10</td> <td>16</td> <td>25</td> <td>35</td> <td>50</td> </tr> <tr> <td>Z-25°C / Z+20°C</td> <td>4</td> <td>3</td> <td>2</td> <td>2</td> <td>2</td> <td>2</td> </tr> <tr> <td>Z-40°C / Z+20°C</td> <td>8</td> <td>6</td> <td>4</td> <td>3</td> <td>3</td> <td>3</td> </tr> </table>	Working Voltage(VDC)	6.3	10	16	25	35	50	Z-25°C / Z+20°C	4	3	2	2	2	2	Z-40°C / Z+20°C	8	6	4	3	3	3
	Working Voltage(VDC)	6.3	10	16	25	35	50															
Z-25°C / Z+20°C	4	3	2	2	2	2																
Z-40°C / Z+20°C	8	6	4	3	3	3																
Endurance	Test condition Duration time :4000Hrs Ambient temperature :+105°C Applied voltage :Rated DC working voltage After test requirement at +20°C Capacitance change : within ±30% of the initial measured value Dissipation factor : ≤300% of the initial specified value Leakage current : ≤The initial specified value																					
Shelf Life	Test condition Duration time :1000Hrs Ambient temperature :+105°C Applied voltage :None After test requirement at +20°C:Same limits as Endurance. Pre-treatment for measurements shall be conducted after application of DC working voltage for 30 minutes.																					

Radial

Multiplier for Ripple Current vs. Frequency

CAP(µF)\Frequency(Hz)	50(60)	120	1K	50-100K
Multiplier	0.65	1.00	1.35	1.5

Diagram of Dimensions:(unit:mm)

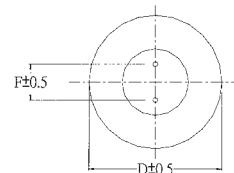
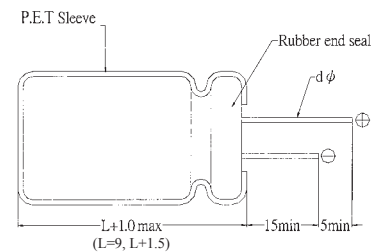

Dφ	4	5	6.3	8	10
F	1.5	2.0	2.5	3.5	5.0
dφ	0.45		0.50	0.50	0.6

Case Size

WV (Vdc)	Cap (uF)	Size (mm)	Rated Ripple current (mA _{rms} /105°C /120Hz)
6.3	22	4x7	35
6.3	33	5x7	43
6.3	47	5x7	50
6.3	100	6.3x7	76
6.3	220	8x7	131
6.3	330	8x9	145
6.3	470	8x9	145
10	22	5x7	42
10	33	5x7	50
10	47	6.3x7	60
10	100	8x7	96
10	220	8x9	145
10	330	8x9	145
10	470	8x9	145
10	470	10x9	165
16	10	4x7	29
16	10	5x7	29
16	22	5x7	46
16	33	6.3x7	58
16	47	6.3x7	70
16	100	6.3x7	95
16	100	8x7	110
16	220	8x9	145
16	330	8x9	145
16	330	10x9	165
16	470	10x9	165

WV (Vdc)	Cap (uF)	Size (mm)	Rated Ripple current (mA _{rms} /105°C /120Hz)
25	10	5x7	36
25	22	6.3x7	52
25	33	6.3x7	65
25	47	6.3x7	70
25	47	8x7	80
25	100	8x7	100
25	100	8x9	145
25	150	8x9	145
25	220	10x9	165
35	10	4x7	26
35	22	6.3x7	60
35	33	8x7	75
35	47	8x9	89
35	100	10x9	165
50	0.1	4x7	2
50	0.22	4x7	3
50	0.33	4x7	4
50	0.47	4x7	5
50	1	4x7	12
50	2.2	4x7	21
50	3.3	4x7	26
50	4.7	5x7	31
50	10	6.3x7	46
50	22	8x7	67
50	33	8x9	89
50	47	8x9	89
50	100	10x9	165

SL Series 7 mm, Low Leakage Current 85°C



Features

- ◆ Low leakage current, height 7 mm
- ◆ RoHS Compliant

Specifications

Item	Performance Characteristics						
Operating Temperature Range	-40 to +85°C						
Rated Voltage Range	6.3 to 50 VDC						
Capacitance Range	0.1 to 220 μ F						
Capacitance Tolerance	±20%(120Hz,+20°C)						
Leakage Current (+20°C,max.)	I ≤ 0.002 CV or 0.4 (μ A) After 2 minutes, whichever is greater measured with rated working voltage applied.						
Dissipation Factor (tan δ , at 20°C , 120Hz)	Working Voltage(VDC)	6.3	10	16	25	35	50
	D.F.(%)max.	22	20	16	14	12	10
Low Temperature Characteristics (at 120Hz)	Impedance ratio max						
	Working Voltage(VDC)	6.3	10	16	25	35	50
	Z-25°C / Z+20°C	8	6	4	4	3	3
Endurance	Test condition						
	Duration time	:1000Hrs					
	Ambient temperature	:+85°C					
	Applied voltage	:Rated DC working voltage					
	After test requirement at +20°C						
	Capacitance change	: with ±20% of the initial measured value(4V:±30%)					
	Dissipation factor	: ≤200% of the initial specified value					
Leakage current	: ≤The initial specified value						
Shelf Life	Test condition						
	Duration time	:1000Hrs					
	Ambient temperature	:+85°C					
	Applied voltage	:None					
	After test requirement at +20°C:Same limits as Endurance.						
Pre-treatment for measurements shall be conducted after application of DC working voltage for 30 minutes.							

Multiplier for Ripple Current vs. Frequency

CAP(μF)\Frequency(Hz)	50(60)	120	400	1K	10K	50K-100K
CAP ≤ 10	0.8	1	1.30	1.45	1.65	1.70
10 < CAP ≤ 220	0.8	1	1.23	1.36	1.48	1.53

Diagram of Dimensions:(unit:mm)

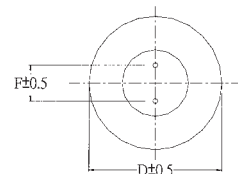
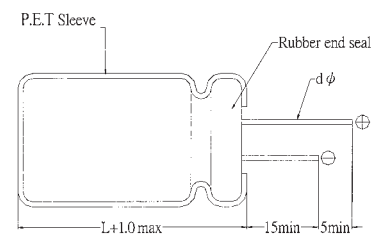

D φ	4	5	6.3	8
F	1.5±0.5	2.0±0.5	2.5±0.5	3.5±0.5
d φ	0.45		0.5	

Radial

Case Size

WV (Vdc)	Cap (uF)	Size (mm)	Rated Ripple current (mA _{rms} /85°C /120Hz)
6.3	22	4x7	31
6.3	33	5x7	40
6.3	47	5x7	48
6.3	100	6.3x7	70
6.3	220	8x7	110
10	22	5x7	35
10	33	5x7	44
10	47	6.3x7	55
10	100	8x7	90
16	10	4x7	25
16	22	5x7	40
16	33	6.3x7	53
16	47	6.3x7	60
16	100	8x7	95
25	10	5x7	30
25	22	6.3x7	48

WV (Vdc)	Cap (uF)	Size (mm)	Rated Ripple current (mA _{rms} /85°C /120Hz)
25	33	6.3x7	59
25	47	8x7	73
35	4.7	4x7	21
35	10	5x7	33
35	22	6.3x7	52
35	33	8x7	65
50	0.1	4x7	1
50	0.22	4x7	2
50	0.33	4x7	3
50	0.47	4x7	5
50	1	4x7	8
50	2.2	4x7	16
50	3.3	4x7	21
50	4.7	5x7	25
50	10	6.3x7	40
50	22	8x7	58

SD Series 7 mm, Low Leakage Current 105°C



Features

- ◆ 105°C Low leakage current, height 7 mm
- ◆ RoHS Compliant

Specifications

Item	Performance Characteristics								
Operating Temperature Range	-40 to +105°C								
Rated Voltage Range	4 to 63 VDC								
Capacitance Range	0.1 to 100 μF								
Capacitance Tolerance	±20% (120Hz, +20°C)								
Leakage Current(+20°C, max)	I ≤ 0.002 CV or 0.4 (μA) After 2 minute, whichever is greater measured with rated working voltage applied.								
Dissipation Factor (tan δ , at 20°C , 120Hz)	Rated Voltage(VDC)	4	6.3	10	16	25	35	50	63
	D.F. (%)max.	25	22	20	16	14	12	10	10
Low Temperature Characteristics (at 120Hz)	Impedance ratio max								
	Rated Voltage(VDC)	4	6.3	10	16	25	35	50	63
	Z-25°C / Z+20°C	6	4	3	3	2	2	2	2
	Z-40°C / Z+20°C	12	10	6	6	4	4	4	3
Endurance	Test conditions								
	Duration time	:1000 Hrs							
	Ambient temperature	:+105°C							
	Applied voltage	:Rated DC working voltage							
	After test requirement at +20°C								
	Capacitance change	: ≤ ±20% of the initial measured value (4V : ≤ ±30%)							
	Dissipation factor	: ≤ 200% of the initial specified value							
	Leakage current	: ≤ The initial specified value							
Shelf Life	Test conditions								
	Duration time	:1000 Hrs							
	Ambient temperature	:+105°C							
	Applied voltage	:None							
	After test requirement at +20°C	: Same limits as Endurance.							
	Pre-treatment for measurements shall be conducted after application of DC working voltage for 30 minutes.								

Radial

Multiplier for Ripple Current vs. Frequency

Frequency(Hz) \ CAP(μF)	50(60)	120	400	1K	≥10K
0.1~10	0.65	1.00	1.20	1.30	1.5
10~100	0.80	1.00	1.10	1.15	1.2

Diagram of Dimensions:(unit:mm)

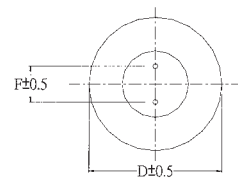
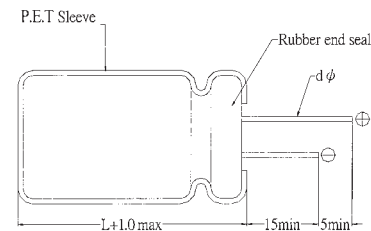

D φ	4	5	6.3	8
F	1.5±0.5	2.0±0.5	2.5±0.5	3.5±0.5
d φ	0.45		0.5	

Case Size

WV (Vdc)	Cap (uF)	Size (mm)	Rated Ripple current (mAmps/105°C /120Hz)
4	33	4x7	33
4	47	4x7	39
4	100	6.3x7	59
6.3	33	4x7	41
6.3	47	5x7	49
6.3	100	6.3x7	75
10	22	4x7	36
10	33	5x7	44
10	47	6.3x7	54
10	100	8x7	90
16	10	4x7	27
16	22	4x7	40
16	33	5x7	50
16	47	6.3x7	62
25	4.7	4x7	19
25	10	5x7	29
25	22	6.3x7	44
25	33	6.3x7	55
25	47	8x7	74
35	3.3	4x7	18
35	4.7	5x7	21

WV (Vdc)	Cap (uF)	Size (mm)	Rated Ripple current (mAmps/105°C /120Hz)
35	10	5x7	32
35	22	6.3x7	49
35	33	8x7	67
50	0.1	4x7	3
50	0.22	4x7	5
50	0.33	4x7	6
50	0.47	4x7	7
50	1	4x7	10
50	2.2	4x7	16
50	3.3	4x7	20
50	4.7	6.3x7	24
50	10	8x7	40
63	0.1	4x7	3
63	0.22	4x7	5
63	0.33	4x7	6
63	0.47	4x7	7
63	1	4x7	10
63	2.2	5x7	19
63	3.3	6.3x7	29
63	4.7	6.3x7	36

SN Series 7 mm Non-polar 85°C



Features

- ◆ Non-polarized with 7 mm height for crossover networks of high-pitched, mean and low-pitched sounds in high-fidelity sound systems.
- ◆ The series offers excellent frequency characteristics and minimal capacitance deviation with frequency.
- ◆ RoHS Compliant

Specifications

Item	Performance Characteristics																					
Operating Temperature Range	-40 to +85°C																					
Rated Voltage Range	6.3 to 50 VDC																					
Capacitance Range	0.1 to 220 µF																					
Capacitance Tolerance	±20%(120Hz,+20°C)																					
Leakage Current (+20°C,max.)	I ≤ 0.05 CV or 10 (µA) After 2 minutes, whichever is greater measured with rated working voltage applied.																					
Dissipation Factor (tan δ , at 20°C , 120Hz)	<table border="1"> <tr> <td>Working Voltage(VDC)</td> <td>6.3</td> <td>10</td> <td>16</td> <td>25</td> <td>35</td> <td>50</td> </tr> <tr> <td>D.F.(%)max.</td> <td>22</td> <td>20</td> <td>16</td> <td>16</td> <td>14</td> <td>12</td> </tr> </table>	Working Voltage(VDC)	6.3	10	16	25	35	50	D.F.(%)max.	22	20	16	16	14	12							
Working Voltage(VDC)	6.3	10	16	25	35	50																
D.F.(%)max.	22	20	16	16	14	12																
Low Temperature Characteristics (at 120Hz)	Impedance ratio max <table border="1"> <tr> <td>Rated Voltage(VDC)</td> <td>6.3</td> <td>10</td> <td>16</td> <td>25</td> <td>35</td> <td>50</td> </tr> <tr> <td>Z-25°C / Z+20°C</td> <td>4</td> <td>3</td> <td>2</td> <td>2</td> <td>2</td> <td>2</td> </tr> <tr> <td>Z-40°C / Z+20°C</td> <td>8</td> <td>6</td> <td>4</td> <td>4</td> <td>3</td> <td>3</td> </tr> </table>	Rated Voltage(VDC)	6.3	10	16	25	35	50	Z-25°C / Z+20°C	4	3	2	2	2	2	Z-40°C / Z+20°C	8	6	4	4	3	3
Rated Voltage(VDC)	6.3	10	16	25	35	50																
Z-25°C / Z+20°C	4	3	2	2	2	2																
Z-40°C / Z+20°C	8	6	4	4	3	3																
Endurance	Test condition Duration time :1000Hrs Ambient temperature :+85°C Applied voltage :Rated DC working voltage to each polarity for 500Hrs After test requirement at +20°C Capacitance change : with ±20% of the initial measured value Dissipation factor : ≤200% of the initial specified value Leakage current : ≤The initial specified value																					
Shelf Life	Test condition Duration time :1000Hrs Ambient temperature :+85°C Applied voltage :None After test requirement at +20°C:Same limits as Endurance. Pre-treatment for measurements shall be conducted after application of DC working voltage for 30 minutes.																					

Radial

Multiplier for Ripple Current vs. Frequency

CAP(µF)\Frequency(Hz)	50(60)	120	400	1K	10K	50K-100K
CAP ≤ 10	0.8	1	1.30	1.45	1.65	1.70
10 < CAP ≤ 220	0.8	1	1.23	1.36	1.48	1.53

Diagram of Dimensions:(unit:mm)

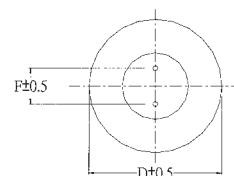
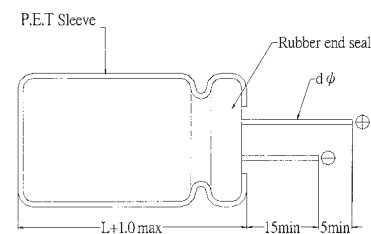

D φ	4	5	6.3	8
F	1.5±0.5	2.0±0.5	2.5±0.5	3.5±0.5
d φ	0.45		0.5	

Case Size

WV (Vdc)	Cap (uF)	Size (mm)	Rated Ripple current (mA _{rms} /85°C /120Hz)
6.3	10	4x7	23
6.3	22	5x7	30
6.3	33	5x7	40
6.3	47	6.3x7	56
6.3	100	8x7	92
6.3	220	8x7	135
10	10	4x7	24
10	22	5x7	38
10	33	6.3x7	55
10	47	6.3x7	65
10	100	8x7	105
16	4.7	4x7	18
16	10	4x7	25
16	10	5x7	30
16	22	6.3x7	51
16	33	6.3x7	60
16	47	6.3x7	73
16	100	8x7	120
25	3.3	4x7	14
25	4.7	4x7	18
25	4.7	5x7	21
25	10	6.3x7	35

WV (Vdc)	Cap (uF)	Size (mm)	Rated Ripple current (mA _{rms} /85°C /120Hz)
25	22	6.3x7	53
25	33	8x7	70
25	47	8x7	80
35	2.2	4x7	13
35	3.3	4x7	15
35	3.3	5x7	16
35	4.7	5x7	22
35	10	6.3x7	37
35	22	8x7	58
35	33	8x7	73
50	0.1	4x7	1
50	0.22	4x7	2
50	0.33	4x7	4
50	0.47	4x7	5
50	1	4x7	10
50	2.2	4x7	14
50	2.2	5x7	16
50	3.3	4x7	18
50	3.3	5x7	20
50	4.7	6.3x7	27
50	10	8x7	44
50	22	8x7	60

SB Series 7 mm Non-polar 105°C



Features

- ◆ Non-polarized with 7mm height for crossover network of high-pitched, mean and low-pitched sounds in high-frequency sound systems.
- ◆ The series offers excellent frequency characteristics and minimal capacitance deviation with frequency.
- ◆ RoHS Compliant

Specifications

Item	Performance Characteristics																					
Operating Temperature Range	-40 to +105°C																					
Rated Voltage Range	6.3 to 50 VDC																					
Capacitance Range	0.1 to 100 μ F																					
Capacitance Tolerance	±20%(120Hz,+20°C)																					
Leakage Current (+20°C,max.)	I ≤0.05 CV or 10 (μ A) After 2 minutes,whichever is greater measured with rated working voltage applied.																					
Dissipation Factor (tan δ , at 20°C , 120Hz)	<table border="1"> <tr> <td>Working Voltage(VDC)</td> <td>6.3</td> <td>10</td> <td>16</td> <td>25</td> <td>35</td> <td>50</td> </tr> <tr> <td>D.F.(%)max.</td> <td>24</td> <td>20</td> <td>16</td> <td>16</td> <td>14</td> <td>12</td> </tr> </table>	Working Voltage(VDC)	6.3	10	16	25	35	50	D.F.(%)max.	24	20	16	16	14	12							
Working Voltage(VDC)	6.3	10	16	25	35	50																
D.F.(%)max.	24	20	16	16	14	12																
Low Temperature Characteristics (at 120Hz)	Impedance ratio max <table border="1"> <tr> <td>Rated Voltage(VDC)</td> <td>6.3</td> <td>10</td> <td>16</td> <td>25</td> <td>35</td> <td>50</td> </tr> <tr> <td>Z-25°C / Z+20°C</td> <td>4</td> <td>3</td> <td>2</td> <td>2</td> <td>2</td> <td>2</td> </tr> <tr> <td>Z-40°C / Z+20°C</td> <td>8</td> <td>6</td> <td>4</td> <td>4</td> <td>3</td> <td>3</td> </tr> </table>	Rated Voltage(VDC)	6.3	10	16	25	35	50	Z-25°C / Z+20°C	4	3	2	2	2	2	Z-40°C / Z+20°C	8	6	4	4	3	3
Rated Voltage(VDC)	6.3	10	16	25	35	50																
Z-25°C / Z+20°C	4	3	2	2	2	2																
Z-40°C / Z+20°C	8	6	4	4	3	3																
Endurance	Test condition Duration time :1000Hrs Ambient temperature :+105°C Applied voltage :Rated DC working voltage to each polarity for 500Hrs After test requirement at +20°C Capacitance change : with ±20% of the initial measured value Dissipation factor : ≤200% of the initial specified value Leakage current : ≤The initial specified value																					
Shelf Life	Test condition Duration time :1000Hrs Ambient temperature :+105°C Applied voltage :None After test requirement at +20°C:Same limits as Endurance. Pre-treatment for measurements shall be conducted after application of DC working voltage for 30 minutes.																					

Radial

Multiplier for Ripple Current vs. Frequency

CAP(μ F)\Frequency(Hz)	50(60)	120	400	1K	10K	50K-100K
CAP ≤10	0.8	1	1.30	1.45	1.65	1.70
10 < CAP ≤220	0.8	1	1.23	1.36	1.48	1.53

Diagram of Dimensions:(unit:mm)

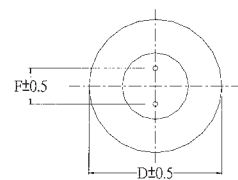
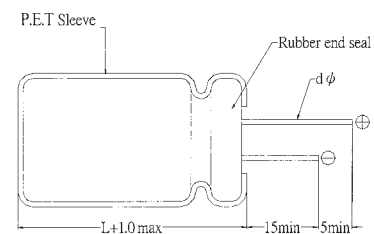

D φ	4	5	6.3	8
F	1.5±0.5	2.0±0.5	2.5±0.5	3.5±0.5
d φ	0.45		0.5	

Case Size

WV (Vdc)	Cap (uF)	Size (mm)	Rated Ripple current (mAmps/105°C /120Hz)
6.3	10	4x7	23
6.3	22	5x7	30
6.3	33	5x7	40
6.3	47	6.3x7	56
6.3	100	8x7	92
10	10	4x7	24
10	22	5x7	38
10	33	6.3x7	52
10	47	8x7	65
10	100	8x7	105
16	4.7	4x7	18
16	10	5x7	30
16	22	6.3x7	51
16	33	6.3x7	58
16	47	8x7	73
16	100	8x7	120
25	3.3	4x7	14
25	4.7	5x7	19
25	10	6.3x7	35

WV (Vdc)	Cap (uF)	Size (mm)	Rated Ripple current (mAmps/105°C /120Hz)
25	22	6.3x7	53
25	33	8x7	70
25	47	8x7	80
35	2.2	4x7	13
35	3.3	5x7	18
35	4.7	5x7	22
35	10	6.3x7	37
35	22	8x7	58
35	33	8x7	70
50	0.1	4x7	1
50	0.22	4x7	2
50	0.33	4x7	4
50	0.47	4x7	5
50	1	4x7	10
50	2.2	5x7	16
50	3.3	5x7	20
50	4.7	6.3x7	27
50	10	8x7	44

SZ Series 7-9 mm Low Impedance

Features

- ◆ Operating temperature range -55 to +105°C
- ◆ 105°C, 1000 hours assured
- ◆ RoHS Compliant

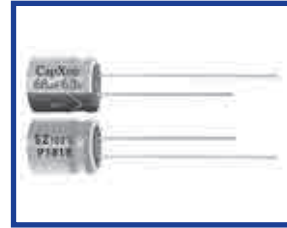

Specifications

Item	Performance Characteristics
Operating Temperature Range	-55 to +105°C
Rated Voltage Range	6.3 to 35 VDC
Capacitance Range	6.8 to 330 µF
Capacitance Tolerance	±20%(120Hz,+20°C)
Leakage Current (+20°C,max.)	I ≤ 0.01 CV or 3 (µA) After 2 minutes,whichever is greater measured with rated working voltage applied.
Dissipation Factor (tan δ , at 20°C , 120Hz)	Working Voltage(VDC) 6.3 10 16 25 35
	D.F.(%)max. 18 16 14 12 12
Low Temperature Characteristics (at 120Hz)	Impedance ratio max
	Rated Voltage(VDC) 6.3 10 16 25 35
	Z-25°C / Z+20°C 2 2 2 2 2
Z-55°C / Z+20°C 3 3 3 3 3	
Endurance	Test condition
	Duration time :1000Hrs
	Ambient temperature :+105°C
	Applied voltage :Rated DC working voltage
	After test requirement at +20°C
	Capacitance change : with ±20% of the initial measured value
Dissipation factor : ≤200% of the initial specified value	
Leakage current : ≤The initial specified value	
Shelf Life	Test condition
	Duration time :1000Hrs
	Ambient temperature :+105°C
	Applied voltage :None
	After test requirement at +20°C:Same limits as Endurance.
	Pre-treatment for measurements shall be conducted after application of DC working voltage for 30 minutes.

Radial

Multiplier for Ripple Current vs. Frequency

CAP(µF)\Frequency(Hz)	50(60)	120	400	1K	10K	50K-100K
CAP ≤ 10	0.47	0.59	0.76	0.85	0.91	1
10 < CAP ≤ 220	0.52	0.65	0.80	0.89	0.97	1
100 < CAP	0.58	0.72	0.84	0.90	0.98	1

Diagram of Dimensions:(unit:mm)

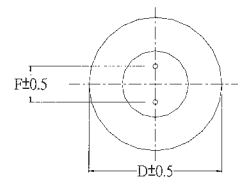
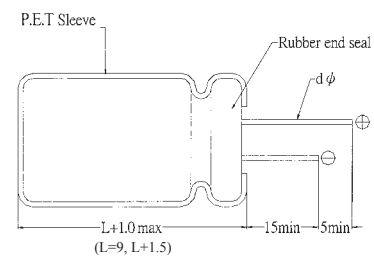

D φ	4	5	6.3	8
F	1.5±0.5	2.0±0.5	2.5±0.5	3.5±0.5
d φ	0.45		0.5	

Case Size

WV (Vdc)	Cap (uF)	Size (mm)	Ripple current (mArms/105°C /100KHz)	Max ESR(Ω) at 20°C/100KHz
6.3	33	5x7	110	1.70
6.3	47	5x7	110	1.70
6.3	68	6.3x7	160	0.80
6.3	100	6.3x7	160	0.80
6.3	120	6.3x7	165	0.70
6.3	150	6.3x7	178	0.60
6.3	180	8x7	190	0.58
6.3	220	8x7	200	0.50
6.3	330	8x7	350	0.35
6.3	470	8x9	400	0.30
10	22	4x7	70	3.30
10	33	5x7	110	1.70
10	47	5x7	160	0.80
10	68	6.3x7	160	0.80
10	100	6.3x7	200	0.50
10	120	6.3x7	205	0.48
10	150	8x7	230	0.45
10	180	8x7	250	0.45
10	220	8x7	280	0.35
10	330	8x9	320	0.30
10	470	10x9	430	0.22
16	22	5x7	115	1.70
16	33	6.3x7	160	0.80
16	47	6.3x7	160	0.80

WV (Vdc)	Cap (uF)	Size (mm)	Ripple current (mArms/105°C /100KHz)	Max ESR(Ω) at 20°C/100KHz
16	68	8x7	200	0.50
16	100	8x7	200	0.45
16	120	8x7	350	0.35
16	150	8x7	370	0.32
16	180	8x7	400	0.30
16	220	8x7	430	0.26
16	330	8x9	500	0.22
25	10	4x7	70	3.00
25	22	5x7	110	1.70
25	33	6.3x7	160	0.80
25	47	8x7	200	0.50
25	68	8x7	200	0.50
25	100	8x7	250	0.35
25	150	8x7	340	0.40
25	180	8x9	450	0.25
25	220	8x9	600	0.22
25	330	10x9	750	0.15
35	6.8	4x7	70	3.30
35	10	5x7	110	1.70
35	22	6.3x7	160	0.80
35	33	8x7	200	0.50
35	47	8x7	245	0.45
35	68	8x7	280	0.42

SY Series 7mm Low Impedance Long Life



Features

- ◆ Operating temperature -55~105°C.
- ◆ 105°C 2000Hours assured.
- ◆ RoHS Compliant

Specifications

Item	Performance Characteristics
Operating Temperature Range	-55 to +105°C
Rated Voltage Range	6.3 to 50 VDC
Capacitance Range	1~330 μF
Capacitance Tolerance	±20%(120Hz,+20°C)
Leakage Current (+20°C,max.)	I ≤ 0.01CV or 3(μA) After 2 minutes with rated working voltage applied.
Dissipation Factor (tan δ , at 20°C , 120Hz)	Working Voltage(VDC) 6.3 10 16 25 35 50
	D.F.(%)max. 18 16 14 12 12 10
Low Temperature Characteristics (at 120Hz)	Impedance ratio max
	Rated Voltage(VDC) 6.3 10 16 25 35 50
	Z-25°C / Z+20°C 2 2 2 2 2 2
	Z-55°C / Z+20°C 3 3 3 3 3 3
Endurance	Test condition Duration time :2000Hrs Ambient temperature :+105°C Applied voltage :Rated DC working voltage After test requirement at +20°C Capacitance change : with ±20% of the initial measured value Dissipation factor : ≤200% of the initial specified value Leakage current : ≤The initial specified value
	Shelf Life
	Test condition Duration time :1000Hrs Ambient temperature :+105°C Applied voltage :None After test requirement at +20°C:Same limits as Endurance. Pre-treatment for measurements shall be conducted after application of DC working voltage for 30 minutes.

Radial

Multiplier for Ripple Current vs. Frequency

CAP(μF)\Frequency(Hz)	50(60)	120	400	1K	10K	50K-100K
1 ≤ CAP ≤ 10	0.47	0.59	0.76	0.85	0.97	1
10 < CAP ≤ 220	0.52	0.65	0.80	0.89	0.97	1
100 < CAP	0.58	0.72	0.84	0.90	0.98	1

Diagram of Dimensions:(unit:mm)

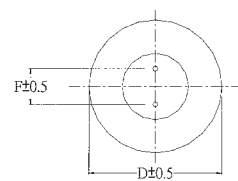
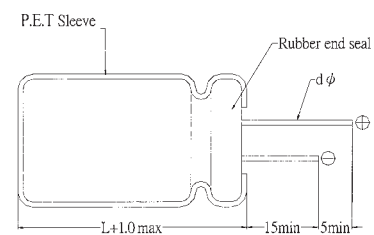

D φ	4	5	6.3	8
F	1.5±0.5	2.0±0.5	2.5±0.5	3.5±0.5
d φ	0.45		0.5	

Case Size

WV (Vdc)	Cap (uF)	Size (mm)	Ripple current (mArms/105°C /100KHz)	Max ESR(Ω) at 20°C/100KHz
6.3	33	5x7	90	1.95
6.3	47	6.3x7	99	1.87
6.3	68	6.3x7	125	1.00
6.3	100	6.3x7	144	0.82
6.3	120	6.3x7	148	0.77
6.3	150	6.3x7	160	0.66
6.3	180	8x7	171	0.64
6.3	220	8x7	180	0.55
6.3	330	8x7	315	0.39
10	22	4x7	63	3.63
10	33	5x7	95	1.90
10	47	5x7	120	1.30
10	68	6.3x7	144	0.88
10	100	6.3x7	180	0.55
10	120	6.3x7	185	0.52
10	150	8x7	207	0.50
10	180	8x7	225	0.49
10	220	8x7	252	0.40
16	10	4x7	60	3.50
16	15	4x7	75	3.00
16	22	5x7	90	2.00
16	33	6.3x7	120	1.40
16	47	6.3x7	140	0.90
16	68	8x7	160	0.65

WV (Vdc)	Cap (uF)	Size (mm)	Ripple current (mArms/105°C /100KHz)	Max ESR(Ω) at 20°C/100KHz
16	100	8x7	180	0.49
16	120	8x7	315	0.93
16	150	8x7	333	0.95
16	180	8x7	360	0.33
16	220	8x7	387	0.29
25	10	4x7	60	3.50
25	22	5x7	99	1.87
25	33	6.3x7	144	0.88
25	47	8x7	160	0.70
25	68	8x7	180	0.55
25	100	8x7	225	0.39
25	150	8x7	306	0.35
35	6.8	4x7	63	3.63
35	10	5x7	99	3.20
35	22	6.3x7	140	0.90
35	33	8x7	180	0.55
35	47	8x7	220	0.50
50	1	4x7	60	3.50
50	2.2	4x7	60	3.50
50	3.3	4x7	60	3.50
50	4.7	4x7	60	3.50
50	6.8	5x7	80	2.20
50	10	6.3x7	135	0.92

GS Series General Purpose 85°C

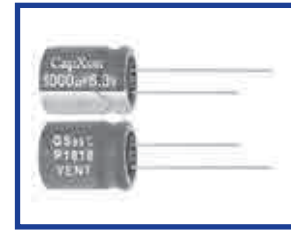

Features

- ◆ Wide CV value range.
- ◆ Endurance 2000 hrs at 85°C.
- ◆ Safety vent construction design.
- ◆ RoHS Compliant

Specifications

Item	Performance Characteristics	
Operating Temperature Range	-40 to +85°C	-25 to +85°C
Rated Voltage Range	6.3 to 100 VDC	160 to 450 VDC
Capacitance Range	0.1 to 33000 µF	0.47 to 560 µF
Capacitance Tolerance	±20% (120Hz, +20°C)	
Leakage Current (+20°C, max.)	I ≤ 0.01 CV or 3 (µA)	I ≤ 0.03 CV (µA)
	After 1 minute whichever is greater measures with rated working voltage applied.	
Dissipation Factor (tan δ, at 20°C, 120Hz)	Working Voltage(VDC)	6.3 10 16 25 35 50 63 100
	D.F. (%)max.	22 19 16 14 12 10 9 8
	Working Voltage(VDC)	160 200 250 350 400 450
	D.F. (%)max.	12 12 12 15 15 17
	For capacitance > 1000 µF, add 2% per another 1000 µF.	
Low Temperature Characteristics (at 120Hz)	Impedance ratio max	
	Working Voltage(VDC)	6.3 10 16 25 35 50 63 100
	Z-25°C/Z+20°C	4 3 2 2 2 2 2 2
	Z-40°C/Z+20°C	8 6 4 3 3 3 3 3
	Working Voltage(VDC)	160 200 250 350 400 450
	Z-25°C/Z+20°C	2 2 3 5 15 15
	For Capacitance > 1000 µF, add 0.5 per another 1000 µF for -25°C/+20°C add 1 per another 1000 µF for -40°C/+20°C	
Endurance	Test conditions Duration time :2000Hrs Ambient temperature :+85°C Applied voltage :Rated DC working voltage After test requirement at +20°C Capacitance change :≤ ±20% of the initial measured value Dissipation factor :≤ 200% of the initial specified value Leakage Current :≤ The initial specified value	
Shelf Life	Test conditions Duration time :1000Hrs Ambient temperature :+85°C Applied voltage :None After test requirement at +20°C: Same limits as Endurance. Pre-treatment for measurements shall be conducted after application of DC working voltage for 30 minutes.	

Radial

Multiplier for Ripple Current vs. Frequency

CAP(µF)/Frequency(Hz)	50(60)	120	400	1K	10K	50K-100K
CAP ≤ 10	0.8	1	1.3	1.45	1.65	1.7
10 < CAP ≤ 100	0.8	1	1.23	1.36	1.48	1.53
100 < CAP ≤ 1000	0.8	1	1.16	1.25	1.35	1.38
1000 < CAP	0.8	1	1.11	1.17	1.25	1.28

Diagram of Dimensions:(unit:mm)

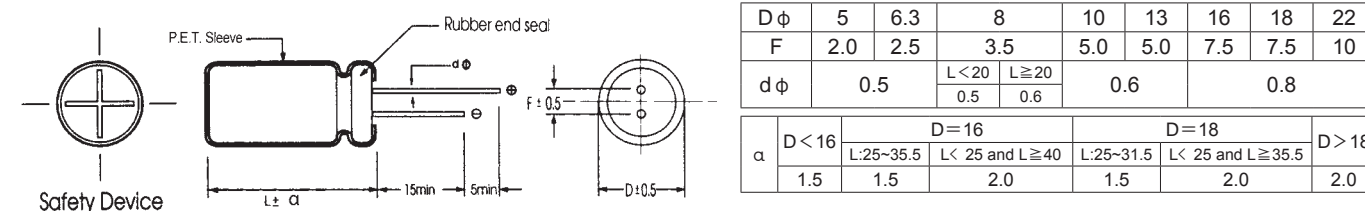

Case Size

WV (Vdc)	Cap (uF)	Size (mm)	Rated Ripple current (mAmps/85°C /120Hz)
6.3	33	5x11	72
6.3	47	5x11	88
6.3	68	5x11	110
6.3	100	5x11	143
6.3	120	5x11	165
6.3	150	5x11	198
6.3	180	5x11	220
6.3	220	5x11	242
6.3	220	6.3x11	264
6.3	330	6.3x11	330
6.3	470	6.3x11	385
6.3	470	8x11.5	418
6.3	560	8x11.5	473
6.3	680	8x11.5	539
6.3	820	8x11.5	605
6.3	1000	8x11.5	649
6.3	1000	10x12.5	715
6.3	1200	10x12.5	814
6.3	1500	10x16	935
6.3	1800	10x16	1035
6.3	2200	10x20	1135
6.3	2700	10x20	1353
6.3	3300	10x20	1430
6.3	3300	13x20	1485
6.3	3900	13x20	1529
6.3	4700	13x20	1672
6.3	4700	13x25	1870
6.3	5600	13x25	2002
6.3	6800	16x25	2310
6.3	8200	16x25	2332
6.3	10000	16x31.5	2530
6.3	12000	16x35.5	2783
6.3	15000	16x35.5	2948
6.3	15000	18x35.5	3168
6.3	18000	18x35.5	3300
6.3	22000	18x40	3575
6.3	33000	22x40	4290
10	22	5x11	66
10	33	5x11	88
10	47	5x11	105
10	68	5x11	132
10	100	5x11	198
10	120	5x11	209
10	150	5x11	231
10	180	6.3x11	253
10	220	6.3x11	294
10	330	6.3x11	363
10	470	6.3x11	418
10	470	8x11.5	440
10	560	8x11.5	506
10	680	8x11.5	572
10	820	10x12.5	671
10	1000	8x16	725
10	1000	8x20	803
10	1000	10x12.5	726
10	1200	10x16	902
10	1500	10x16	1001
10	1800	10x20	1089
10	2200	10x20	1210
10	2200	13x20	1330

WV (Vdc)	Cap (uF)	Size (mm)	Rated Ripple current (mAmps/85°C /120Hz)
10	2700	13x20	1419
10	3300	13x20	1540
10	3900	13x20	1760
10	4700	13x25	1980
10	5600	16x25	2189
10	6800	16x25	2475
10	8200	16x31.5	2541
10	10000	16x35.5	2640
10	10000	18x35.5	2915
10	12000	18x35.5	3025
10	15000	18x35.5	3310
10	18000	18x40	3410
10	22000	22x40	4092
10	33000	22x50	4620
16	10	5x11	44
16	22	5x11	83
16	33	5x11	84
16	47	5x11	132
16	68	5x11	149
16	100	5x11	176
16	100	6.3x11	204
16	120	6.3x11	231
16	150	6.3x11	253
16	180	6.3x11	275
16	220	6.3x11	308
16	220	8x11.5	352
16	330	8x11.5	407
16	470	8x11.5	517
16	560	10x12.5	572
16	680	8x16	640
16	680	10x12.5	682
16	820	10x16	803
16	1000	10x16	869
16	1200	10x16	979
16	1500	10x20	1100
16	1800	13x20	1298
16	2200	13x20	1485
16	2700	13x20	1716
16	3300	13x20	1750
16	3300	13x25	1870
16	3900	16x25	2002
16	4700	16x25	2310
16	5600	16x31.5	2453
16	6800	16x31.5	2805
16	8200	16x35.5	2893
16	10000	18x35.5	2970
16	10000	18x40	3190
16	12000	18x35.5	3058
16	12000	18x40	3212
16	15000	22x40	3905
25	4.7	5x11	34
25	10	5x11	50
25	22	5x11	94
25	33	5x11	105
25	47	5x11	132
25	68	6.3x11	176
25	100	6.3x11	209
25	120	6.3x11	253
25	150	6.3x11	275
25	180	6.3x11	280

WV (Vdc)	Cap (uF)	Size (mm)	Rated Ripple current (mA rms/85°C /120Hz)
25	180	8x11.5	319
25	220	6.3x11	310
25	220	8x11.5	363
25	330	8x11.5	451
25	330	10x12.5	484
25	470	8x11.5	561
25	470	10x12.5	594
25	560	10x16	693
25	680	10x16	792
25	680	10x20	825
25	820	10x20	891
25	1000	10x20	1050
25	1200	13x20	1155
25	1500	13x20	1353
25	1800	13x20	1496
25	2200	13x25	1705
25	2700	16x25	1804
25	3300	16x25	1870
25	3300	16x31.5	2145
25	3900	16x31.5	2343
25	4700	16x31.5	2640
25	5600	18x31.5	2816
25	6800	18x35.5	2970
25	8200	18x35.5	2981
25	10000	22x40	3960
35	4.7	5x11	44
35	10	5x11	66
35	22	5x11	108
35	33	5x11	121
35	47	5x11	143
35	47	6.3x11	154
35	68	6.3x11	198
35	100	6.3x11	231
35	100	8x11.5	253
35	120	8x11.5	275
35	150	8x11.5	308
35	180	8x11.5	352
35	220	8x11.5	385
35	220	10x12.5	407
35	330	10x12.5	528
35	330	10x16	539
35	470	10x16	693
35	470	10x20	748
35	560	10x20	847
35	680	10x20	891
35	820	13x20	1045
35	1000	13x20	1265
35	1200	13x20	1375
35	1500	13x25	1570
35	1800	16x25	1749
35	2200	16x25	1870
35	2200	16x31.5	1980
35	2700	16x31.5	2178
35	3300	16x31.5	2365
35	3300	16x35.5	2552
35	3900	18x31.5	2640
35	4700	18x35.5	2860
35	5600	18x40	2915
35	6800	22x40	3630
50	0.1	5x11	3.3
50	0.22	5x11	3
50	0.33	5x11	6

WV (Vdc)	Cap (uF)	Size (mm)	Rated Ripple current (mA rms/85°C /120Hz)
50	0.47	5x11	8
50	1	5x11	17
50	2.2	5x11	28
50	3.3	5x11	39
50	4.7	5x11	46
50	10	5x11	72
50	22	5x11	110
50	33	5x11	132
50	33	6.3x11	138
50	47	6.3x11	165
50	68	8x11.5	220
50	100	8x11.5	286
50	120	8x11.5	319
50	150	10x12.5	363
50	180	10x12.5	418
50	220	10x12.5	468
50	220	10x16	484
50	330	10x16	649
50	330	10x20	671
50	470	10x20	828
50	470	13x20	858
50	560	13x20	902
50	680	13x20	1056
50	820	13x25	1287
50	1000	13x25	1485
50	1000	16x25	1540
50	1200	16x25	1617
50	1500	16x31.5	1848
50	1800	16x31.5	2112
50	2200	16x35.5	2310
50	2700	18x31.5	2420
50	3300	18x35.5	2750
50	3900	18x40	2871
50	4700	22x40	3355
63	0.1	5x11	4
63	0.22	5x11	4
63	0.33	5x11	6
63	0.47	5x11	8
63	1	5x11	17
63	2.2	5x11	31
63	3.3	5x11	39
63	4.7	5x11	50
63	10	5x11	77
63	22	6.3x11	127
63	33	6.3x11	149
63	33	8x11.5	160
63	47	6.3x11	198
63	47	8x11.5	209
63	68	8x11.5	253
63	100	10x12.5	330
63	120	10x16	396
63	150	10x16	462
63	180	10x16	528
63	220	10x16	550
63	220	10x20	583
63	330	10x20	759
63	330	13x20	781
63	470	13x20	968
63	470	13x25	1023
63	560	13x25	1056
63	560	16x25	1089
63	680	16x25	1265

WV (Vdc)	Cap (uF)	Size (mm)	Rated Ripple current (mAmps/85°C /120Hz)
63	820	16x25	1430
63	1000	16x25	1540
63	1000	16x31.5	1705
63	1200	16x31.5	1837
63	1500	16x35.5	2090
63	1800	16x35.5	2255
63	2200	18x35.5	2475
63	2200	18x40	2750
63	2700	22x40	2860
63	3300	22x40	3080
100	0.1	5x11	4.5
100	0.22	5x11	6
100	0.33	5x11	10
100	0.47	5x11	14
100	1	5x11	27
100	2.2	5x11	40
100	3.3	5x11	48
100	4.7	5x11	58
100	10	5x11	85
100	10	6.3x11	92
100	22	6.3x11	157
100	22	8x11.5	164
100	33	8x11.5	206
100	33	10x12.5	218
100	47	10x12.5	278
100	47	10x16	303
100	68	10x16	387
100	100	10x20	472
100	120	10x20	532
100	150	13x20	629
100	180	13x20	667
100	220	13x25	740
100	220	16x25	872
100	330	13x25	920
100	330	16x25	1040
100	470	16x25	1210
100	470	16x31.5	1330
100	560	16x35.5	1465
100	680	16x35.5	1634
100	820	18x35.5	1815
100	1000	18x40	1940
160	0.47	5x11	12
160	1	5x11	17
160	2.2	6.3x11	30
160	3.3	6.3x11	36
160	4.7	6.3x11	40
160	4.7	8x11.5	48
160	10	8x11.5	80
160	22	10x12.5	135
160	33	10x16	180
160	47	10x20	230
160	68	13x20	360
160	100	13x25	430
160	120	16x25	530
160	150	16x25	560
160	180	16x31.5	650
160	220	16x31.5	850
160	220	16x35.5	890
160	330	18x31.5	890
160	330	18x35.5	920
160	470	18x35.5	1180
160	470	18x40	1250

WV (Vdc)	Cap (uF)	Size (mm)	Rated Ripple current (mAmps/85°C /120Hz)
160	560	18x45	1320
200	0.47	5x11	12
200	1	6.3x11	17
200	2.2	6.3x11	30
200	3.3	6.3x11	36
200	4.7	8x11.5	51
200	10	10x12.5	83
200	10	10x16	88
200	22	10x20	135
200	33	13x20	205
200	47	13x20	250
200	47	13x25	280
200	68	13x25	370
200	100	16x25	460
200	120	16x25	550
200	150	16x31.5	580
200	180	16x31.5	660
200	220	18x31.5	750
200	220	18x35.5	800
200	330	18x35.5	940
200	330	18x40	1000
200	470	18x40	1330
250	0.47	5x11	12
250	1	6.3x11	17
250	2.2	6.3x11	20
250	2.2	8x11.5	33
250	3.3	8x11.5	38
250	3.3	10x12.5	43
250	4.7	8x11.5	48
250	4.7	10x12.5	51
250	10	10x12.5	90
250	22	10x20	135
250	22	13x20	165
250	33	13x20	210
250	33	13x25	220
250	47	13x20	240
250	47	13x25	260
250	47	13x25	260
250	68	13x25	340
250	68	16x25	390
250	100	16x25	410
250	100	16x31.5	450
250	120	16x31.5	560
250	150	18x31.5	600
250	180	18x31.5	680
350	0.47	6.3x11	15
350	1	6.3x11	22
350	2.2	8x11.5	30
350	2.2	10x12.5	32
350	3.3	8x11.5	46
350	3.3	10x12.5	51
350	4.7	8x11.5	55
350	4.7	10x12.5	63
350	4.7	10x16	66
350	10	10x16	115
350	10	10x20	125
350	22	13x20	180
350	33	13x20	225
350	33	13x25	250
350	47	16x25	290
350	68	16x31.5	400
350	100	18x31.5	430

WV (Vdc)	Cap (uF)	Size (mm)	Rated Ripple current (mA _{rms} /85°C /120Hz)
350	120	18x35.5	550
350	150	18x40	570
400	0.47	6.3x11	12
400	0.47	8x11.5	12
400	1	6.3x11	20
400	1	8x11.5	22
400	2.2	8x11.5	32
400	2.2	10x12.5	35
400	3.3	8x11.5	45
400	3.3	10x12.5	53
400	4.7	8x11.5	55
400	4.7	10x12.5	66
400	4.7	10x16	70
400	10	10x16	100
400	10	10x20	115
400	10	13x20	120
400	22	13x20	190
400	22	13x25	200
400	33	13x25	230
400	33	16x25	250
400	47	16x25	270
400	47	16x31.5	290
400	68	16x35.5	410
400	68	18x25	380
400	68	18x31.5	420
400	100	18x31.5	440

WV (Vdc)	Cap (uF)	Size (mm)	Rated Ripple current (mA _{rms} /85°C /120Hz)
400	100	18x35.5	450
400	120	18x40	520
450	0.47	6.3x11	12
450	1	8x11.5	22
450	2.2	8x11.5	32
450	2.2	10x12.5	35
450	3.3	8x11.5	35
450	3.3	10x12.5	37
450	3.3	10x16	40
450	4.7	10x12.5	50
450	4.7	10x16	56
450	10	10x20	90
450	10	13x20	105
450	10	13x25	110
450	22	13x20	140
450	22	13x25	150
450	22	16x25	165
450	33	16x25	190
450	33	16x31.5	210
450	47	16x31.5	260
450	47	16x35.5	280
450	68	18x31.5	370
450	68	18x35.5	390
450	100	18x40	420
450	120	18x45	510

GW Series 9-25 mm height Low Profile 85°C

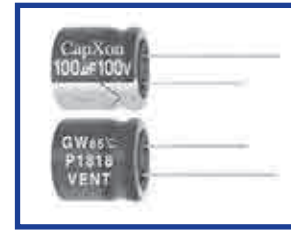

Features

- ◆ Miniaturized low profile.
- ◆ Height 9mm-25mm max.
- ◆ Safety vent construction design.
- ◆ RoHS Compliant

Specifications

Item	Performance Characteristics																																
Operating Temperature Range	-40 to +85°C	-25 to +85°C																															
Rated Voltage Range	6.3 to 100 VDC	160 to 450 VDC																															
Capacitance Range	2.2 to 10000 µF	2.2 to 220 µF																															
Capacitance Tolerance	±20% (120Hz, +20°C)																																
Leakage Current (+20°C, max.)	I ≤ 0.01 CV or 3 (µA) After 2 minutes whichever is greater measured with rated working voltage applied.	I ≤ 0.04 CV+100 (µA) After 2 minutes with rated working voltage applied.																															
	<table border="1"> <tr> <td>Working Voltage(VDC)</td> <td>6.3</td> <td>10</td> <td>16</td> <td>25</td> <td>35</td> <td>50</td> <td>63</td> <td>100</td> </tr> <tr> <td>D.F. (%)max.</td> <td>24</td> <td>22</td> <td>20</td> <td>14</td> <td>12</td> <td>12</td> <td>10</td> <td>10</td> </tr> </table> <table border="1"> <tr> <td>Working Voltage(VDC)</td> <td>160</td> <td>200</td> <td>250</td> <td>350</td> <td>400</td> <td>450</td> </tr> <tr> <td>D.F. (%)max.</td> <td>15</td> <td>15</td> <td>15</td> <td>20</td> <td>20</td> <td>20</td> </tr> </table> <p>For capacitance > 1000 µF, add 2% per another 1000 µF.</p>		Working Voltage(VDC)	6.3	10	16	25	35	50	63	100	D.F. (%)max.	24	22	20	14	12	12	10	10	Working Voltage(VDC)	160	200	250	350	400	450	D.F. (%)max.	15	15	15	20	20
Working Voltage(VDC)	6.3	10	16	25	35	50	63	100																									
D.F. (%)max.	24	22	20	14	12	12	10	10																									
Working Voltage(VDC)	160	200	250	350	400	450																											
D.F. (%)max.	15	15	15	20	20	20																											
Dissipation Factor (tan δ, at 20°C, 120Hz)	Impedance ratio max																																
	<table border="1"> <tr> <td>Working Voltage(VDC)</td> <td>6.3</td> <td>10</td> <td>16</td> <td>25</td> <td>35</td> <td>50</td> <td>63</td> <td>100</td> </tr> <tr> <td>Z-25°C/Z+20°C</td> <td>6</td> <td>4</td> <td>4</td> <td>3</td> <td>2</td> <td>2</td> <td>2</td> <td>2</td> </tr> <tr> <td>Z-40°C/Z+20°C</td> <td>12</td> <td>10</td> <td>8</td> <td>6</td> <td>4</td> <td>3</td> <td>3</td> <td>3</td> </tr> </table>		Working Voltage(VDC)	6.3	10	16	25	35	50	63	100	Z-25°C/Z+20°C	6	4	4	3	2	2	2	2	Z-40°C/Z+20°C	12	10	8	6	4	3	3	3				
	Working Voltage(VDC)	6.3	10	16	25	35	50	63	100																								
	Z-25°C/Z+20°C	6	4	4	3	2	2	2	2																								
Z-40°C/Z+20°C	12	10	8	6	4	3	3	3																									
<table border="1"> <tr> <td>Working Voltage(VDC)</td> <td>160</td> <td>200</td> <td>250</td> <td>350</td> <td>400</td> <td>450</td> </tr> <tr> <td>Z-25°C/Z+20°C</td> <td>2</td> <td>2</td> <td>3</td> <td>5</td> <td>5</td> <td>7</td> </tr> </table> <p>For Capacitance > 1000 µF, add 0.5 per another 1000 µF for -25°C/+20°C add 1 per another 1000 µF for -40°C/+20°C</p>		Working Voltage(VDC)	160	200	250	350	400	450	Z-25°C/Z+20°C	2	2	3	5	5	7																		
Working Voltage(VDC)	160	200	250	350	400	450																											
Z-25°C/Z+20°C	2	2	3	5	5	7																											
For capacitance > 1000 µF, add 2% per another 1000 µF.																																	
Low Temperature Characteristics (at 120Hz)	Impedance ratio max																																
	<table border="1"> <tr> <td>Working Voltage(VDC)</td> <td>6.3</td> <td>10</td> <td>16</td> <td>25</td> <td>35</td> <td>50</td> <td>63</td> <td>100</td> </tr> <tr> <td>Z-25°C/Z+20°C</td> <td>6</td> <td>4</td> <td>4</td> <td>3</td> <td>2</td> <td>2</td> <td>2</td> <td>2</td> </tr> <tr> <td>Z-40°C/Z+20°C</td> <td>12</td> <td>10</td> <td>8</td> <td>6</td> <td>4</td> <td>3</td> <td>3</td> <td>3</td> </tr> </table>		Working Voltage(VDC)	6.3	10	16	25	35	50	63	100	Z-25°C/Z+20°C	6	4	4	3	2	2	2	2	Z-40°C/Z+20°C	12	10	8	6	4	3	3	3				
Working Voltage(VDC)	6.3	10	16	25	35	50	63	100																									
Z-25°C/Z+20°C	6	4	4	3	2	2	2	2																									
Z-40°C/Z+20°C	12	10	8	6	4	3	3	3																									
Endurance	Test conditions																																
	Duration time :2000Hrs Ambient temperature :+85°C Applied voltage :Rated DC working voltage After test requirement at +20°C Capacitance change :≤ ±20% of the initial measured value Dissipation factor :≤ 200% of the initial specified value Leakage current :≤ The initial specified value																																
Shelf Life	Test conditions																																
	Duration time :1000Hrs Ambient temperature :+85°C Applied voltage :None After test requirement at +20°C: Same limits as Endurance. Pre-treatment for measurements shall be conducted after application of DC working voltage for 30 minutes.																																

Multiplier for Ripple Current vs. Frequency

CAP(µF)/Frequency(Hz)	50(60)	120	400	1K	≥10K
2.2~47	0.80	1.00	1.20	1.30	1.50
100~1000	0.80	1.00	1.10	1.15	1.20
2200~10000	0.80	1.00	1.05	1.10	1.15

Diagram of Dimensions:(unit:mm)

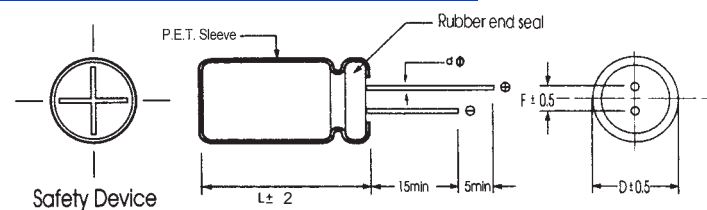

Dφ	5	6.3	8	10	13	16	18
F	2.0	2.5	3.5	5.0	5.0	7.5	7.5
dφ	0.5		0.6		0.8		

Case Size

WV (Vdc)	Cap (uF)	Size (mm)	Rated Ripple current (mAmps/85°C /120Hz)
6.3	100	5x9	128
6.3	150	5x9	150
6.3	220	6.3x9	180
6.3	330	6.3x9	247
6.3	470	8x9	360
6.3	680	10x9	420
6.3	1000	10x9	530
6.3	2200	13x16	1050
6.3	3300	16x16	1200
6.3	4700	16x16	1500
6.3	6800	16x20	1550
6.3	6800	18x16	1600
6.3	10000	18x20	2000
10	100	5x9	134
10	150	6.3x9	180
10	220	6.3x9	210
10	330	8x9	300
10	470	8x9	360
10	680	10x9	540
10	1000	10x12.5	625
10	2200	13x16	1080
10	3300	16x16	1350
10	4700	16x20	1550
10	6800	18x20	1850
16	68	5x9	120
16	100	6.3x9	160
16	150	6.3x9	260
16	220	8x9	290
16	330	8x9	340
16	330	10x9	355
16	470	10x9	410
16	680	10x12.5	560
16	1000	13x13	750
16	2200	16x16	1150
16	3300	16x16	1500
16	3300	18x16	1460
16	4700	18x20	1650
25	47	5x9	105
25	68	6.3x9	130
25	100	6.3x9	175
25	150	8x9	280
25	220	8x9	310
25	330	10x9	400
25	470	10x12.5	525
25	680	10x16	700
25	680	13x13	730
25	1000	13x16	1050
25	2200	16x20	1350
25	2200	18x16	1300
25	3300	18x20	1600
35	33	5x9	95
35	47	6.3x9	120
35	68	6.3x9	140
35	100	8x9	220
35	150	8x9	300
35	220	10x9	335
35	330	10x12.5	475
35	470	13x13	590
35	470	13x16	650
35	680	13x16	750

WV (Vdc)	Cap (uF)	Size (mm)	Rated Ripple current (mAmps/85°C /120Hz)
35	1000	16x16	1230
35	2200	18x20	1600
50	2.2	5x9	23
50	3.3	5x9	30
50	4.7	5x9	35
50	6.8	5x9	50
50	10	5x9	64
50	22	5x9	86
50	33	6.3x9	115
50	47	6.3x9	135
50	68	8x9	155
50	100	10x9	230
50	150	10x9	320
50	220	10x16	380
50	220	13x13	400
50	330	13x13	530
50	330	13x16	550
50	470	13x16	720
50	470	16x16	750
50	680	16x16	805
50	1000	16x20	1450
63	2.2	5x9	26
63	3.3	5x9	31
63	4.7	5x9	36
63	6.8	5x9	54
63	10	6.3x9	68
63	22	6.3x9	102
63	33	8x9	135
63	47	10x9	170
63	68	10x9	200
63	100	10x16	340
63	150	13x13	384
63	220	13x13	490
63	330	16x16	610
63	470	16x16	840
63	680	16x20	950
100	2.2	5x9	27
100	3.3	5x9	33
100	4.7	6.3x9	41
100	6.8	6.3x9	59
100	10	8x9	78
100	22	8x9	107
100	33	10x9	155
100	47	10x16	220
100	68	10x16	261
100	68	13x13	270
100	100	13x13	410
100	150	16x16	579
100	220	16x20	668
100	330	16x25	864
160	4.7	8x9	50
160	6.8	8x9	75
160	10	10x9	87
160	22	10x16	135
160	33	13x16	175
160	47	13x16	285
160	47	16x16	325
160	68	16x16	340
160	100	16x20	515
160	150	18x20	620

WV (Vdc)	Cap (uF)	Size (mm)	Rated Ripple current (mA rms/85°C /120Hz)
200	4.7	8x9	55
200	6.8	8x9	78
200	10	10x9	92
200	22	13x16	150
200	33	13x16	190
200	33	16x16	200
200	47	16x16	320
200	68	16x16	360
200	68	18x16	390
200	100	16x20	575
250	4.7	8x9	60
250	4.7	10x9	52
250	6.8	10x9	82
250	10	10x9	98
250	10	10x16	120
250	22	13x16	165
250	22	16x16	210
250	33	16x16	230
250	33	18x16	260
250	47	16x20	340
250	47	18x16	380
250	68	16x20	420
250	100	18x20	610
350	3.3	8x9	45
350	4.7	10x9	78

WV (Vdc)	Cap (uF)	Size (mm)	Rated Ripple current (mA rms/85°C /120Hz)
350	6.8	10x16	105
350	10	13x16	145
350	22	16x16	190
350	33	16x20	270
350	33	18x16	335
350	47	18x20	360
400	2.2	8x9	38
400	3.3	10x9	50
400	4.7	10x9	90
400	6.8	13x16	125
400	10	13x16	160
400	10	16x16	190
400	22	16x20	230
400	22	18x16	225
400	33	18x20	300
400	47	18x20	385
450	1.5	8x9	30
450	2.2	10x9	46
450	3.3	10x9	55
450	4.7	10x12.5	105
450	6.8	13x16	135
450	10	16x16	200
450	22	16x20	250
450	33	18x20	320

KM Series Standard 105°C



Features

- ◆ Used in communication equipments, switching power supply, etc.
- ◆ Safety vent construction design.
- ◆ RoHS Compliant

Specifications

Item	Performance Characteristics	
Operating Temperature Range	-40 to +105°C	-25 to +105°C
Rated Voltage Range	6.3 to 100 VDC	160 to 500 VDC
Capacitance Range	0.1 to 22000 µF	0.47 to 560 µF
Capacitance Tolerance	±20% (120Hz, +20°C)	
Leakage Current (+20°C, max.)	I ≤ 0.01 CV or 3 (µA) After 1 minute whichever is greater measured with rated working voltage applied.	I ≤ 0.03 CV (µA) After 1 minute with rated working voltage applied.
Dissipation Factor (tan δ, at 20°C, 120Hz)	Working Voltage(VDC)	6.3 10 16 25 35 50 63 100
	D.F. (%)max.	22 17 16 14 12 10 9 8
	Working Voltage(VDC)	160 200 250 350 400 420 450 500
	D.F. (%)max.	12 12 12 15 15 17 17 22
For capacitance > 1000 µF, add 2% per another 1000 µF.		
Low Temperature Characteristics (at 120Hz)	Impedance ratio max	
	Working Voltage(VDC)	6.3 10 16 25 35 50 63 100
	Z-25°C / Z+20°C	4 3 2 2 2 2 2 2
	Z-40°C / Z+20°C	8 6 4 3 3 3 3 3
	Working Voltage(VDC)	160 200 250 350 400 420 450 500
	Z-25°C / Z+20°C	2 2 3 5 6 6 6 6
For Capacitance > 1000 µF, add 0.5 per another 1000 µF for -25°C / +20°C add 1 per another 1000 µF for -40°C / +20°C		
Endurance	Test conditions Duration time :2000Hrs Ambient temperature :+105°C Applied voltage :Rated DC working voltage After test requirement at +20°C Capacitance change :≤ ±20% of the initial measured value Dissipation factor :≤ 200% of the initial specified value Leakage current :≤ The initial specified value	
Shelf Life	Test conditions Duration time :1000Hrs Ambient temperature :+105°C Applied voltage :None After test requirement at +20°C: Same limits as Endurance. Pre-treatment for measurements shall be conducted after application of DC working voltage for 30 minutes.	

Radial

Multiplier for Ripple Current vs. Frequency

CAP(µF)/Frequency(Hz)	50(60)	120	400	1K	10K	50K-100K
CAP ≤ 10	0.80	1.00	1.30	1.45	1.65	1.7
10 < CAP ≤ 100	0.80	1.00	1.23	1.36	1.48	1.53
100 < CAP ≤ 1000	0.80	1.00	1.16	1.25	1.35	1.38
1000 < CAP	0.80	1.00	1.11	1.17	1.25	1.28

Diagram of Dimensions:(unit:mm)

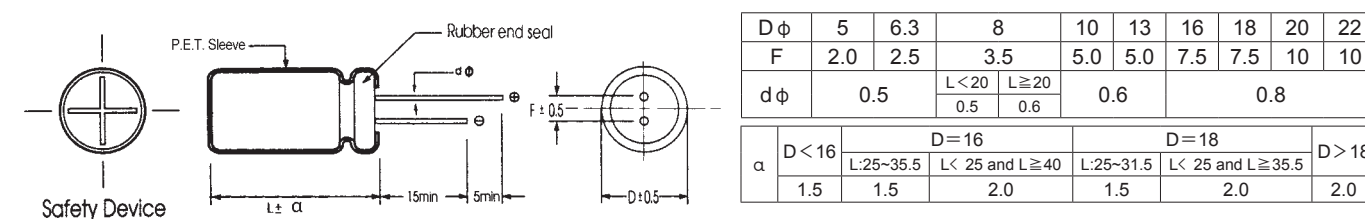

Case Size

WV (Vdc)	Cap (uF)	Size (mm)	Rated Ripple current (mA rms/85°C /120Hz)
6.3	33	5x11	54
6.3	47	5x11	65
6.3	68	5x11	75
6.3	100	5x11	96
6.3	120	5x11	110
6.3	150	5x11	120
6.3	150	6.3x11	130
6.3	180	6.3x11	140
6.3	220	6.3x11	160
6.3	330	6.3x11	195
6.3	470	6.3x11	220
6.3	470	8x11.5	270
6.3	560	8x11.5	310
6.3	680	8x11.5	360
6.3	820	8x11.5	390
6.3	1000	10x12.5	430
6.3	1200	10x12.5	550
6.3	1500	10x16	625
6.3	1800	10x16	710
6.3	2200	10x16	750
6.3	2200	10x20	775
6.3	2700	10x20	850
6.3	3300	13x20	960
6.3	3900	13x20	1000
6.3	4700	13x20	1150
6.3	5600	13x25	1300
6.3	6800	13x25	1480
6.3	8200	16x25	1520
6.3	10000	16x25	1680
6.3	12000	16x31.5	1750
6.3	15000	16x35.5	2075
6.3	18000	18x31.5	2150
6.3	22000	18x40	2300
10	22	5x11	45
10	33	5x11	60
10	47	5x11	70
10	68	5x11	80
10	100	5x11	105
10	120	5x11	110
10	120	6.3x11	120
10	150	5x11	120
10	150	6.3x11	145
10	180	6.3x11	160
10	220	6.3x11	175
10	330	6.3x11	205
10	330	8x11.5	255
10	470	6.3x11	235
10	470	8x11.5	290
10	560	8x11.5	330
10	560	10x12.5	340
10	680	8x11.5	365
10	680	8x16	410
10	820	10x12.5	480
10	1000	10x12.5	520
10	1200	10x16	630
10	1500	8x20	715
10	1500	10x16	770
10	1800	10x20	820
10	2200	10x20	860
10	2700	10x25	880

WV (Vdc)	Cap (uF)	Size (mm)	Rated Ripple current (mA rms/85°C /120Hz)
10	2700	13x20	920
10	3300	13x20	1100
10	3900	13x20	1280
10	4700	13x25	1350
10	5600	16x25	1490
10	6800	16x25	1670
10	8200	16x31.5	1840
10	10000	16x35.5	1900
10	12000	16x35.5	2050
10	15000	18x35.5	2180
10	18000	18x35.5	2205
16	10	5x11	35
16	22	5x11	54
16	33	5x11	64
16	47	5x11	100
16	68	5x11	105
16	100	5x11	115
16	100	6.3x11	130
16	120	6.3x11	155
16	150	6.3x11	170
16	180	6.3x11	190
16	220	6.3x11	215
16	330	6.3x11	225
16	330	8x11.5	265
16	470	8x11.5	370
16	470	8x16	400
16	560	10x12.5	410
16	680	8x16	470
16	680	10x12.5	480
16	820	10x16	550
16	1000	10x12.5	540
16	1000	10x16	600
16	1200	10x20	700
16	1500	10x20	820
16	1800	13x20	920
16	2200	13x20	1000
16	2700	13x20	1080
16	3300	13x25	1200
16	3900	16x25	1490
16	4700	16x25	1600
16	5600	16x31.5	1720
16	6800	16x31.5	1900
16	8200	16x35.5	2020
16	10000	18x35.5	2060
16	12000	18x35.5	2150
25	4.7	5x11	26
25	6.8	5x11	32
25	10	5x11	38
25	22	5x11	58
25	33	5x11	69
25	47	5x11	105
25	68	6.3x11	120
25	100	6.3x11	145
25	120	6.3x11	175
25	150	6.3x11	180
25	150	8x11.5	200
25	180	8x11.5	210
25	220	8x11.5	235
25	330	8x11.5	310
25	330	10x12.5	335

WV (Vdc)	Cap (uF)	Size (mm)	Rated Ripple current (mA _{rms} /85°C /120Hz)
25	470	8x11.5	410
25	470	10x12.5	440
25	560	10x16	460
25	680	10x16	520
25	820	10x20	640
25	1000	10x20	710
25	1200	13x20	810
25	1500	13x20	900
25	1800	13x25	1050
25	2200	13x25	1200
25	2700	16x25	1320
25	3300	16x25	1460
25	3900	16x31.5	1670
25	4700	16x35.5	1780
25	5600	16x35.5	1890
25	6800	18x35.5	2050
25	8200	18x35.5	2090
35	4.7	5x11	28
35	6.8	5x11	36
35	10	5x11	46
35	22	5x11	61
35	33	5x11	75
35	47	5x11	110
35	68	6.3x11	140
35	100	6.3x11	160
35	100	8x11.5	175
35	120	8x11.5	185
35	150	8x11.5	215
35	180	8x11.5	225
35	180	10x12.5	265
35	220	8x11.5	255
35	220	10x12.5	300
35	330	10x12.5	400
35	470	10x16	520
35	560	10x20	540
35	680	10x20	560
35	680	13x20	650
35	820	13x20	760
35	1000	13x20	830
35	1200	13x20	900
35	1200	13x25	930
35	1500	13x25	960
35	1800	16x25	1150
35	2200	16x25	1290
35	2200	16x31.5	1350
35	2700	16x31.5	1480
35	3300	16x35.5	1650
35	3900	18x31.5	1820
35	4700	18x35.5	1900
35	5600	18x35.5	2000
50	0.1	5x11	1
50	0.22	5x11	3
50	0.33	5x11	4
50	0.47	5x11	7
50	1	5x11	13
50	2.2	5x11	20
50	3.3	5x11	26
50	4.7	5x11	32
50	6.8	5x11	40
50	10	5x11	48
50	22	5x11	60
50	22	6.3x11	70

WV (Vdc)	Cap (uF)	Size (mm)	Rated Ripple current (mA _{rms} /85°C /120Hz)
50	33	5x11	75
50	33	6.3x11	90
50	47	6.3x11	115
50	68	6.3x11	130
50	68	8x11.5	155
50	100	8x11.5	200
50	120	8x16	220
50	120	10x12.5	225
50	150	10x12.5	245
50	180	10x12.5	260
50	180	10x16	280
50	220	10x12.5	345
50	220	10x16	360
50	330	10x16	450
50	330	10x20	470
50	470	10x20	600
50	470	13x20	650
50	560	13x20	660
50	680	13x20	700
50	680	13x25	770
50	820	13x25	850
50	1000	13x25	890
50	1000	16x25	1000
50	1200	16x25	1150
50	1500	16x31.5	1300
50	1800	16x35.5	1480
50	2200	16x35.5	1530
50	2700	18x35.5	1590
50	3300	18x35.5	1750
63	0.1	5x11	1
63	0.22	5x11	3
63	0.33	5x11	5
63	0.47	5x11	7
63	1	5x11	13
63	2.2	5x11	20
63	3.3	5x11	28
63	4.7	5x11	32
63	6.8	5x11	40
63	10	5x11	42
63	10	6.3x11	48
63	22	6.3x11	82
63	33	6.3x11	100
63	47	6.3x11	125
63	47	8x11.5	140
63	68	8x11.5	155
63	68	10x12.5	185
63	100	10x12.5	230
63	120	10x16	255
63	150	10x16	270
63	180	10x16	310
63	220	10x16	375
63	220	10x20	400
63	330	13x20	580
63	470	13x20	690
63	560	13x25	770
63	680	16x25	880
63	820	16x25	920
63	1000	16x31.5	1185
63	1200	16x35.5	1200
63	1500	18x31.5	1350
100	0.1	5x11	2
100	0.22	5x11	3

WV (Vdc)	Cap (uF)	Size (mm)	Rated Ripple current (mA rms/85°C /120Hz)
100	0.33	5x11	5
100	0.47	5x11	10
100	1	5x11	15
100	2.2	5x11	21
100	3.3	5x11	30
100	4.7	5x11	35
100	6.8	6.3x11	47
100	10	6.3x11	56
100	10	8x11.5	60
100	22	6.3x11	75
100	22	8x11.5	90
100	33	8x11.5	140
100	33	10x12.5	155
100	47	8x16	165
100	47	10x12.5	170
100	68	10x16	240
100	100	10x20	280
100	120	10x20	295
100	150	13x20	340
100	150	13x25	360
100	180	13x20	410
100	180	13x25	480
100	220	13x25	520
100	330	16x25	690
100	470	16x25	820
100	470	16x31.5	860
100	560	16x35.5	900
100	680	16x35.5	920
100	680	18x31.5	950
100	820	18x35.5	1020
100	1000	18x40	1200
160	0.47	5x11	11
160	1	5x11	17
160	1	6.3x11	19
160	2.2	6.3x11	25
160	3.3	6.3x11	32
160	4.7	6.3x11	38
160	4.7	8x11.5	42
160	6.8	8x11.5	56
160	10	8x11.5	63
160	10	10x12.5	75
160	22	10x12.5	95
160	22	10x16	105
160	22	10x20	120
160	33	10x16	155
160	33	10x20	170
160	47	10x20	180
160	47	13x20	210
160	68	13x20	260
160	68	13x25	280
160	100	13x25	310
160	100	16x25	330
160	120	13x25	320
160	120	16x25	350
160	150	16x25	470
160	180	16x25	550
160	220	16x31.5	560
160	220	16x35.5	580
160	330	18x31.5	660
160	330	18x35.5	700
160	470	18x35.5	810
160	470	18x40	860

WV (Vdc)	Cap (uF)	Size (mm)	Rated Ripple current (mA rms/85°C /120Hz)
200	0.47	5x11	12
200	1	6.3x11	17
200	2.2	6.3x11	25
200	3.3	6.3x11	33
200	3.3	8x11.5	35
200	4.7	6.3x11	42
200	4.7	8x11.5	50
200	6.8	8x11.5	60
200	6.8	10x12.5	63
200	10	8x11.5	78
200	10	10x12.5	85
200	22	10x16	125
200	22	10x20	130
200	33	10x16	160
200	33	10x20	180
200	33	13x20	190
200	47	13x20	220
200	68	13x20	270
200	68	13x25	300
200	100	13x25	320
200	100	16x25	345
200	120	16x25	360
200	120	16x31.5	390
200	150	16x25	440
200	150	16x31.5	480
200	180	16x31.5	550
200	180	16x35.5	560
200	220	16x35.5	670
200	220	18x31.5	690
200	330	18x35.5	750
200	330	18x40	810
200	470	18x40	840
200	470	22x40	925
200	560	18x50	940
250	0.47	5x11	8
250	1	6.3x11	16
250	2.2	6.3x11	20
250	2.2	8x11.5	25
250	3.3	8x11.5	33
250	4.7	8x11.5	46
250	4.7	10x12.5	50
250	6.8	8x11.5	60
250	6.8	10x12.5	70
250	10	8x11.5	68
250	10	10x12.5	80
250	22	10x16	110
250	22	10x20	125
250	22	13x20	150
250	33	13x20	190
250	47	13x20	230
250	47	13x25	240
250	56	13x20	255
250	56	13x25	280
250	68	13x25	310
250	68	16x25	355
250	82	16x25	370
250	100	16x25	375
250	100	16x31.5	395
250	120	16x31.5	420
250	120	16x35.5	430
250	150	16x35.5	460
250	150	18x31.5	460

WV (Vdc)	Cap (uF)	Size (mm)	Rated Ripple current (mA rms/85°C /120Hz)
250	180	18x31.5	465
250	180	18x35.5	470
250	220	18x35.5	650
250	220	18x40	700
250	330	18x45	720
250	330	22x40	780
350	0.47	6.3x11	13
350	1	6.3x11	16
350	2.2	8x11.5	31
350	3.3	8x11.5	34
350	3.3	10x12.5	38
350	4.7	8x11.5	47
350	4.7	10x12.5	52
350	6.8	10x12.5	79
350	10	10x16	87
350	10	10x20	92
350	22	13x20	160
350	22	13x25	170
350	33	13x20	180
350	33	13x25	200
350	47	16x25	245
350	47	16x31.5	260
350	56	16x25	330
350	68	16x31.5	370
350	82	16x35.5	385
350	100	18x31.5	390
350	120	16x40	400
350	120	18x35.5	400
350	150	18x40	420
350	180	18x40	430
350	220	22x40	500
400	0.47	6.3x11	14
400	1	6.3x11	17
400	2.2	6.3x15	34
400	2.2	8x11.5	35
400	2.2	10x12.5	40
400	3.3	6.3x15	35
400	3.3	8x11.5	36
400	3.3	8x16	40
400	3.3	10x12.5	41
400	4.7	8x11.5	48
400	4.7	8x16	54
400	4.7	10x12.5	55
400	4.7	10x16	65
400	6.8	8x14	75
400	6.8	8x15	77
400	6.8	8x16	80
400	6.8	10x12.5	82
400	6.8	10x16	90
400	10	10x14	104
400	10	10x15	107
400	10	10x16	110
400	10	10x20	125
400	22	10x25	162
400	22	13x20	170
400	22	13x25	190
400	33	13x20	235
400	33	13x25	260
400	33	16x25	290
400	47	16x25	300
400	47	16x31.5	360
400	47	18x25	320

WV (Vdc)	Cap (uF)	Size (mm)	Rated Ripple current (mA rms/85°C /120Hz)
400	56	16x25	360
400	56	16x31.5	400
400	68	16x25	410
400	68	16x31.5	450
400	68	16x35.5	480
400	68	18x25	440
400	68	18x31.5	500
400	82	16x31.5	480
400	82	18x25	470
400	82	18x31.5	520
400	100	16x31.5	490
400	100	16x35.5	520
400	100	18x31.5	530
400	100	18x35.5	550
400	120	18x31.5	550
400	120	18x35.5	580
400	150	18x35.5	610
400	150	18x40	650
400	150	22x30	640
400	180	18x45	700
420	0.47	6.3x11	14
420	1	8x11.5	20
420	2.2	8x11.5	35
420	3.3	10x12.5	42
420	4.7	10x12.5	58
420	4.7	10x16	61
420	6.8	10x16	84
420	10	10x20	112
420	22	13x25	185
420	33	16x25	230
420	47	16x25	280
420	47	16x31.5	310
420	56	16x35.5	390
420	68	18x31.5	470
420	82	18x31.5	475
420	82	18x35.5	500
420	100	16x35.5	525
420	100	18x31.5	535
420	100	18x35.5	555
420	120	18x31.5	560
420	120	18x35.5	590
420	120	18x40	630
420	150	18x35.5	615
420	150	18x40	660
420	180	18x45	680
420	180	20x40	685
450	0.47	6.3x11	14
450	1	8x11.5	20
450	2.2	8x11.5	30
450	2.2	10x12.5	35
450	3.3	8x11.5	32
450	3.3	10x12.5	38
450	3.3	10x16	42
450	4.7	8x16	44
450	4.7	10x16	50
450	4.7	10x12.5	45
450	4.7	10x16	50
450	6.8	10x12.5	58
450	6.8	10x16	65
450	6.8	10x20	72
450	10	10x16	80
450	10	10x20	92

WV (Vdc)	Cap (uF)	Size (mm)	Rated Ripple current (mAmps/85°C /120Hz)
450	10	13x20	98
450	22	13x20	165
450	22	16x25	200
450	22	13x25	180
450	33	13x25	185
450	33	16x25	210
450	33	16x31.5	230
450	47	16x25	305
450	47	16x31.5	340
450	47	16x35.5	380
450	47	18x25	350
450	47	18x31.5	360
450	56	16x31.5	370
450	56	16x35.5	400
450	56	18x25	370
450	68	16x31.5	425
450	68	16x35.5	450
450	68	18x25	410
450	68	18x31.5	460
450	68	18x35.5	470
450	82	18x31.5	465
450	82	18x35.5	480
450	100	18x31.5	500
450	100	18x35.5	525
450	100	18x40	560
450	120	18x40	580
450	120	20x35	580
450	120	22x40	650
450	150	18x45	690
450	150	20x40	695
450	150	22x35	695
450	150	22x40	720
500	1	8x11.5	20
500	1	8x16	23
500	1	10x12.5	24

WV (Vdc)	Cap (uF)	Size (mm)	Rated Ripple current (mAmps/85°C /120Hz)
500	2.2	8x16	32
500	2.2	10x12.5	33
500	2.2	10x16	36
500	3.3	10x12.5	38
500	3.3	10x16	42
500	3.3	10x20	49
500	4.7	10x16	50
500	4.7	10x20	58
500	6.8	10x16	63
500	6.8	10x20	70
500	6.8	13x20	80
500	10	10x20	90
500	10	13x20	98
500	10	13x25	115
500	22	13x25	160
500	22	16x25	180
500	33	16x31.5	230
500	33	18x25	220
500	47	18x25	330
500	47	18x31.5	360
500	47	16x35.5	360
500	56	16x35.5	390
500	56	16x40	420
500	56	18x31.5	400
500	68	16x45	480
500	68	18x35.5	460
500	68	18x40	490
500	82	16x45	490
500	82	18x35.5	470
500	82	18x40	500
500	100	18x40	550
500	100	18x45	570
500	100	20x40	580
500	120	20x45	600
500	150	22x45	750

KW Series 9-25 mm Low Profile 105°C



Features

- ◆ Used space-saving equipment, low profile.
- ◆ Endurance 2000 hrs at 105°C.
- ◆ Safety vent construction design.
- ◆ RoHS Compliant

Specifications

Item	Performance Characteristics	
Operating Temperature Range	-40 to +105°C	-25 to +105°C
Rated Voltage Range	6.3 to 100 VDC	160 to 450 VDC
Capacitance Range	2.2 to 10000 µF	1.5 to 150 µF
Capacitance Tolerance	±20% (120Hz, +20°C)	
Leakage Current (+20°C, max.)	I ≤ 0.01 CV or 3 (µA) After 2 minutes whichever is greater measures with rated working voltage applied.	I ≤ 0.04 CV + 100 (µA) After 2 minutes with rated working voltage applied.
Dissipation Factor (tan δ, at 20°C, 120Hz)	Working Voltage(VDC)	6.3 10 16 25 35 50 63 100
	D.F. (%)max.	24 22 20 16 14 12 10 10
	Working Voltage(VDC)	160 200 250 350 400 450
	D.F. (%)max.	15 15 15 15 20 20
For capacitance > 1000 µF, add 2% per another 1000 µF.		
Low Temperature Characteristics (at 120Hz)	Impedance ratio max	
	Working Voltage(VDC)	6.3 10 16 25 35 50 63 100
	Z-25°C / Z+20°C	4 3 2 2 2 2 2 2
	Z-40°C / Z+20°C	8 6 4 4 3 3 3 3
Working Voltage(VDC)	160 200 250 350 400 450	
Z-25°C / Z+20°C	3 3 3 6 6 6	
For Capacitance > 1000 µF, add 0.5 per another 1000 µF for -25°C / +20°C add 1 per another 1000 µF for -40°C / +20°C		
Endurance	Test conditions Duration time :2000Hrs Ambient temperature :+105°C Applied voltage :Rated DC working voltage After test requirement at +20°C Capacitance change :≤ ±20% of the initial measured value Dissipation factor :≤ 200% of the initial specified value Leakage current :≤ The initial specified value	
Shelf Life	Test conditions Duration time :1000Hrs Ambient temperature :+105°C Applied voltage :None After test requirement at +20°C: Same limits as Endurance. Pre-treatment for measurements shall be conducted after application of DC working voltage for 30 minutes.	

Radial

Multiplier for Ripple Current vs. Frequency

CAP(µF) / Frequency(Hz)	50(60)	120	400	1K	≥10K
0.47 < CAP ≤ 100	0.80	1.00	1.20	1.30	1.50
100 < CAP ≤ 1000	0.80	1.00	1.10	1.15	1.20
2200 < CAP ≤ 10000	0.80	1.00	1.05	1.10	1.15

Diagram of Dimensions:(unit:mm)

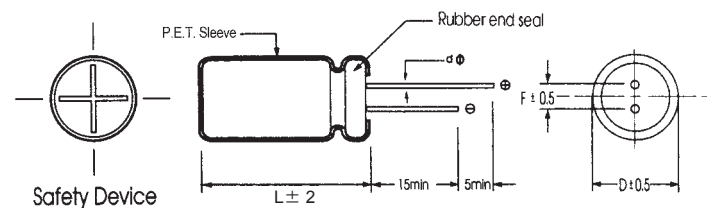

D φ	5	6.3	8	10	13	16	18
F	2.0	2.5	3.5	5.0	5.0	7.5	7.5
d φ	0.5		0.6		0.8		

Case Size

WV (Vdc)	Cap (uF)	Size (mm)	Rated Ripple current (mAmps/105°C /120Hz)
6.3	100	5x9	120
6.3	150	5x9	135
6.3	220	6.3x9	165
6.3	330	6.3x9	185
6.3	470	8x9	260
6.3	680	10x9	310
6.3	1000	10x9	370
6.3	2200	13x16	620
6.3	3300	16x16	860
6.3	4700	16x16	1010
6.3	6800	16x16	1210
6.3	10000	18x20	1450
10	68	5x9	115
10	100	5x9	135
10	150	6.3x9	150
10	220	6.3x9	165
10	330	8x9	205
10	470	8x9	275
10	470	10x9	280
10	680	10x9	360
10	1000	10x9	450
10	2200	13x16	690
10	3300	16x16	950
10	4700	16x20	1150
10	6800	18x20	1350
10	10000	18x25	1700
16	47	5x9	105
16	68	6.3x9	125
16	100	6.3x9	150
16	150	6.3x9	160
16	220	8x9	200
16	330	8x9	250
16	470	10x9	310
16	680	13x13	390
16	1000	13x13	520
16	2200	16x16	850
16	3300	16x20	1180
16	4700	18x20	1480
16	6800	18x25	1600
25	47	5x9	110
25	68	6.3x9	130
25	100	6.3x9	160
25	150	8x9	185
25	220	8x9	230
25	330	10x9	310
25	470	10x12.5	370
25	680	13x16	520
25	1000	13x16	600
25	2200	16x20	950
25	2200	18x16	940
25	3300	18x20	1250
25	4700	18x25	1470
35	33	5x9	90
35	47	6.3x9	120
35	68	8x9	145
35	100	8x9	180
35	150	8x9	210
35	220	10x9	255
35	330	10x12.5	360
35	470	13x13	410

WV (Vdc)	Cap (uF)	Size (mm)	Rated Ripple current (mAmps/105°C /120Hz)
35	470	13x16	430
35	680	13x16	580
35	1000	16x16	750
35	2200	18x20	1200
35	3300	18x25	1450
50	2.2	5x9	19
50	3.3	5x9	25
50	4.7	5x9	40
50	6.8	5x9	48
50	10	5x9	54
50	22	5x9	75
50	33	6.3x9	115
50	47	6.3x9	130
50	68	8x9	169
50	100	10x9	200
50	150	10x9	250
50	220	10x12.5	290
50	330	13x13	375
50	330	13x16	400
50	470	16x16	550
50	680	16x16	700
50	1000	16x20	850
50	2200	18x25	1300
63	2.2	5x9	20
63	3.3	5x9	26
63	4.7	5x9	41
63	6.8	5x9	49
63	10	5x9	55
63	22	6.3x9	107
63	33	6.3x9	114
63	47	8x9	136
63	68	10x9	170
63	100	10x9	173
63	150	10x16	245
63	220	13x13	317
63	330	13x16	382
63	470	16x16	490
63	680	16x20	730
63	1000	16x25	1050
100	2.2	5x9	20
100	3.3	5x9	27
100	4.7	5x9	42
100	6.8	6.3x9	56
100	10	8x9	72
100	22	8x9	114
100	33	10x9	141
100	47	10x16	197
100	68	10x16	200
100	100	13x13	247
100	150	13x16	295
100	150	16x16	346
100	220	16x16	373
100	330	16x20	500

WV (Vdc)	Cap (uF)	Size (mm)	Rated Ripple current (mA _{rms} /105°C /120Hz)
160	4.7	8x9	50
160	6.8	8x9	55
160	10	10x9	80
160	22	13x16	120
160	33	13x16	175
160	47	16x16	225
160	68	16x20	305
160	100	16x20	380
160	150	18x20	530
200	4.7	8x9	50
200	6.8	8x9	58
200	10	10x9	78
200	22	13x16	145
200	33	16x16	200
200	47	16x16	240
200	68	16x20	360
200	100	18x20	410
250	4.7	8x9	50
250	6.8	10x9	65
250	10	13x16	82
250	22	13x16	165
250	22	16x16	180
250	33	16x16	225
250	47	18x16	350
250	68	18x20	390

WV (Vdc)	Cap (uF)	Size (mm)	Rated Ripple current (mA _{rms} /105°C /120Hz)
350	3.3	8x9	35
350	4.7	10x9	50
350	6.8	13x16	80
350	10	13x16	95
350	22	16x16	180
350	33	16x20	225
350	47	18x20	300
400	2.2	8x9	35
400	3.3	10x9	40
400	4.7	13x16	50
400	6.8	13x16	80
400	10	13x16	100
400	10	16x16	105
400	22	16x20	185
400	33	16x20	230
400	47	18x20	309
450	1.5	8x9	18
450	2.2	10x9	25
450	3.3	10x9	30
450	4.7	13x16	48
450	6.8	13x16	68
450	10	16x16	100
450	22	16x20	170

KC 105°C 3000 hours, Ultra Miniaturize

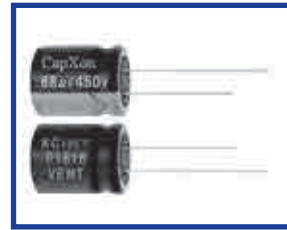

Features

- ◆ Endurance 3000 hours 105°C
- ◆ ROHS compliant

Specifications

Item	Performance Characteristics			
Operating Temperature Range	-25 to +105°C			
Rated Voltage Range	400 to 450 VDC			
Capacitance Tolerance	±20% (120Hz, +20°C)			
Leakage Current (+20°C, max.)	$I \leq 3 \sqrt{CV} (\mu A)$ After 5 minute with rated working voltage applied. C:rated Capacitance (μF) · V:working voltage(V)			
Dissipation Factor (tan δ , at 20°C , 120Hz)	Less than the value under table			
	<table border="1"> <tr> <td>Cap(μF) / W.V.(V)</td> <td>400~450V</td> </tr> <tr> <td>tan δ</td> <td>20%</td> </tr> </table>	Cap(μF) / W.V.(V)	400~450V	tan δ
Cap(μF) / W.V.(V)	400~450V			
tan δ	20%			
Low Temperature Characteristics (at 120Hz)	Impedance ratio max			
	<table border="1"> <tr> <td>Rated voltage(V)</td> <td>400~450</td> </tr> <tr> <td>Z-25°C / Z+20°C</td> <td>8</td> </tr> </table>	Rated voltage(V)	400~450	Z-25°C / Z+20°C
Rated voltage(V)	400~450			
Z-25°C / Z+20°C	8			
Endurance	Test conditions Duration time :3000Hrs Ambient temperature :+105°C Applied voltage :Rated DC working voltage After test requirement at +20°C Capacitance change :Within ±20% of the initial measured value Dissipation factor :Not more than 200% of the initial specified value Leakage current :Not more than The initial specified value			
Shelf Life	Test conditions Duration time :1000Hrs Ambient temperature :+105°C Applied voltage :None After test requirement at +20°C:Same limits as Endurance. Pre-treatment for measurements shall be conducted after application of DC working voltage for 30 minutes.			

Multiplier for Ripple Current vs. Frequency

Frequency(Hz)	50(60)	120	400	1K	10K	50K-100K	
Coefficient	400~450V	0.8	1	1.30	1.45	1.5	1.65

Diagram of Dimensions:(unit:mm)

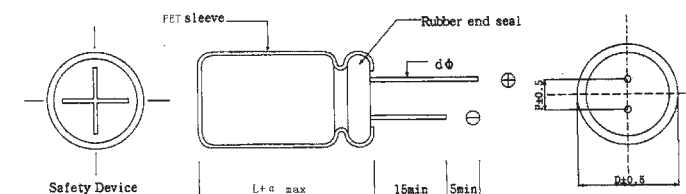

φ D	10~13	16~18
F	5.0	7.5
φ d	0.6	0.8
α	2.0	

Radial

Case Size

WV (Vdc)	Cap (uF)	Size (mm)	Rated Ripple current (mA _{rms} /105°C /120Hz)
400	82	16x25	600
400	100	16x31.5	710
400	120	16x35.5	800
400	150	16x40	920
400	150	18x31.5	890
400	180	16x50	1080
400	180	18x40	1060
400	220	18x45	1200
420	100	16x31.5	690
420	120	16x35.5	780
420	120	18x31.5	800
420	150	16x45	940
420	150	18x35.5	920
420	180	16x50	1050

WV (Vdc)	Cap (uF)	Size (mm)	Rated Ripple current (mA _{rms} /105°C /120Hz)
420	180	18x40	1040
420	220	18x50	1220
450	82	16x31.5	640
450	100	16x35.5	730
450	120	16x40	820
450	120	18x31.5	800
450	150	16x50	980
450	150	18x40	970
450	180	18x45	1090
450	180	18x45	1090
450	220	18x50	1220

LL Series Low Leakage Current



Features

- ◆ Extremely low and stable leakage current characteristics.
- ◆ Close capacitance tolerance $\pm 20\%$ ($\pm 10\%$ on requested)
- ◆ RoHS Compliant

Specifications

Item	Performance Characteristics																
Operating Temperature Range	-40 to +105°C																
Rated Voltage Range	6.3 to 63 VDC																
Capacitance Range	0.1 to 2200 μ F																
Capacitance Tolerance	$\pm 20\%$ (120Hz, +20°C)																
Leakage Current(+20°C, max)	$I \leq 0.002 CV$ or $0.4 (\mu A)$ After 3 minutes(90sec. $\leq 10 \mu F$) whichever is greater measured with rated working voltage applied.																
Dissipation Factor ($\tan \delta$, at 20°C , 120Hz)	<table border="1"> <thead> <tr> <th>Rated Voltage(VDC)</th> <th>6.3</th> <th>10</th> <th>16</th> <th>25</th> <th>35</th> <th>50</th> <th>63</th> </tr> </thead> <tbody> <tr> <td>D.F. (%)max.</td> <td>20</td> <td>17</td> <td>13</td> <td>10</td> <td>9</td> <td>8</td> <td>8</td> </tr> </tbody> </table>	Rated Voltage(VDC)	6.3	10	16	25	35	50	63	D.F. (%)max.	20	17	13	10	9	8	8
Rated Voltage(VDC)	6.3	10	16	25	35	50	63										
D.F. (%)max.	20	17	13	10	9	8	8										
Low Temperature Characteristics (at 120Hz)	Impedance ratio max <table border="1"> <thead> <tr> <th>Rated Voltage(VDC)</th> <th>6.3</th> <th>10</th> <th>16</th> <th>25</th> <th>35</th> <th>50</th> <th>63</th> </tr> </thead> <tbody> <tr> <td>Z-40°C / Z+20°C</td> <td>4</td> <td>3</td> <td>3</td> <td>2</td> <td>2</td> <td>2</td> <td>2</td> </tr> </tbody> </table>	Rated Voltage(VDC)	6.3	10	16	25	35	50	63	Z-40°C / Z+20°C	4	3	3	2	2	2	2
Rated Voltage(VDC)	6.3	10	16	25	35	50	63										
Z-40°C / Z+20°C	4	3	3	2	2	2	2										
Endurance	Test conditions Duration time :2000Hrs Ambient temperature :+105°C Applied voltage :Rated DC working voltage After test requirement at +20°C Capacitance change : $\leq \pm 20\%$ of the initial measured value Dissipation factor : $\leq 150\%$ of the initial specified value Leakage current : \leq The initial specified value																
Shelf Life	Test conditions Duration time :1000Hrs Ambient temperature :+105°C Applied voltage :None After test requirement at +20°C: Same limits as Endurance. Pre-treatment for measurements shall be conducted after application of DC working voltage for 30 minutes.																

Multiplier for Ripple Current vs. Frequency

CAP (μ F) / Frequency(Hz)	50(60)	120	400	1K	10K	50K-100K
CAP ≤ 10	0.80	1.00	1.30	1.45	1.65	1.7
10 < CAP ≤ 100	0.80	1.00	1.23	1.36	1.48	1.53
100 < CAP ≤ 2200	0.80	1.00	1.16	1.25	1.35	1.38

Diagram of Dimensions:(unit:mm)

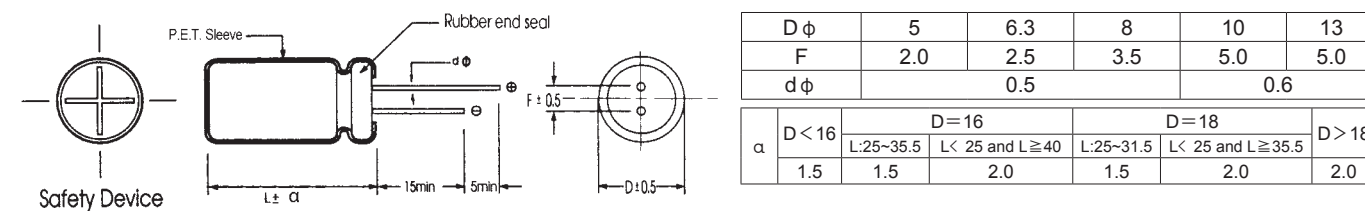

Case Size

WV (Vdc)	Cap (uF)	Size (mm)	Rated Ripple current (mA _{rms} /105°C /120Hz)
6.3	22	5x11	36
6.3	33	5x11	44
6.3	47	5x11	53
6.3	100	5x11	74
6.3	220	6.3x11	131
6.3	330	6.3x11	161
6.3	470	8x11.5	242
6.3	1000	10x12.5	390
6.3	2200	13x20	665
10	22	5x11	50
10	33	5x11	66
10	47	5x11	75
10	100	5x11	104
10	220	8x11.5	193
10	330	8x11.5	256
10	470	8x11.5	319
10	1000	10x16	605
10	2200	13x20	860
16	10	5x11	39
16	22	5x11	62
16	33	5x11	68
16	47	5x11	105
16	100	6.3x11	138
16	220	8x11.5	220
16	330	8x11.5	268
16	470	10x12.5	407
16	1000	10x20	704
16	2200	13x25	890
25	4.7	5x11	32
25	10	5x11	43
25	22	5x11	65
25	33	5x11	76
25	47	6.3x11	116
25	100	8x11.5	149
25	220	10x12.5	246
25	330	10x12.5	352
25	470	10x16	484
25	1000	13x20	847

WV (Vdc)	Cap (uF)	Size (mm)	Rated Ripple current (mA _{rms} /105°C /120Hz)
35	4.7	5x11	33
35	10	5x11	48
35	22	6.3x11	71
35	33	6.3x11	83
35	47	6.3x11	125
35	100	8x11.5	187
35	220	10x12.5	330
35	330	10x16	440
35	470	13x20	590
35	1000	13x25	1012
50	0.1	5x11	9
50	0.22	5x11	9
50	0.33	5x11	9
50	0.47	5x11	12
50	1	5x11	17
50	2.2	5x11	24
50	3.3	5x11	29
50	4.7	5x11	36
50	10	5x11	52
50	22	6.3x11	77
50	33	6.3x11	99
50	47	8x11.5	138
50	100	10x12.5	217
50	220	10x20	380
50	330	13x20	506
50	470	13x25	705
63	0.1	5x11	9
63	0.22	5x11	9
63	0.33	5x11	9
63	0.47	5x11	12
63	1	5x11	17
63	2.2	5x11	24
63	3.3	5x11	32
63	4.7	5x11	39
63	10	6.3x11	58
63	22	6.3x11	94
63	33	8x11.5	110
63	47	8x11.5	152
63	100	10x16	260
63	220	13x20	440
63	330	13x25	594

GL Series Low Impedance, Long Life



Features

- ◆ Low impedance for high frequency, Anti-Solvent Design.
- ◆ Long Life 2000 ~ 6000 hrs at 105°C depending on case size.
- ◆ Radial type for switching power supply.
- ◆ RoHS Compliant

Specifications

Item	Performance Characteristics																																
Operating Temperature Range	-55 to +105°C																																
Rated Voltage Range	6.3 to 63 VDC																																
Capacitance Range	0.47 to 10000 µF																																
Capacitance Tolerance	±20% (120Hz, +20°C)																																
Leakage Current (+20°C, max.)	I ≤ 0.01 CV or 3 (µA) After 2 minutes whichever is greater measured with rated working voltage applied.																																
Dissipation Factor (tan δ, at 20°C, 120Hz)	<table border="1"> <tr> <th>Working Voltage (VDC)</th> <td>6.3</td><td>10</td><td>16</td><td>25</td><td>35</td><td>50</td><td>63</td> </tr> <tr> <th>D.F. (%)max</th> <td>20</td><td>18</td><td>16</td><td>14</td><td>12</td><td>10</td><td>9</td> </tr> </table>	Working Voltage (VDC)	6.3	10	16	25	35	50	63	D.F. (%)max	20	18	16	14	12	10	9																
	Working Voltage (VDC)	6.3	10	16	25	35	50	63																									
D.F. (%)max	20	18	16	14	12	10	9																										
For Capacitance > 1000 µF, add 2% per another 1000 µF.																																	
Low Temperature Characteristics (at 120Hz)	Impedance ratio max																																
	<table border="1"> <tr> <th>Working Voltage(VDC)</th> <td>6.3</td><td>10</td><td>16</td><td>25</td><td>35</td><td>50</td><td>63</td> </tr> <tr> <th>Z-25°C / Z+20°C</th> <td>4</td><td>3</td><td>2</td><td>2</td><td>1.5</td><td>1.5</td><td>1.5</td> </tr> <tr> <th>Z-40°C / Z+20°C</th> <td>6</td><td>4</td><td>3</td><td>3</td><td>2</td><td>2</td><td>2</td> </tr> <tr> <th>Z-55°C / Z+20°C</th> <td>8</td><td>6</td><td>5</td><td>5</td><td>4</td><td>4</td><td>4</td> </tr> </table>	Working Voltage(VDC)	6.3	10	16	25	35	50	63	Z-25°C / Z+20°C	4	3	2	2	1.5	1.5	1.5	Z-40°C / Z+20°C	6	4	3	3	2	2	2	Z-55°C / Z+20°C	8	6	5	5	4	4	4
	Working Voltage(VDC)	6.3	10	16	25	35	50	63																									
	Z-25°C / Z+20°C	4	3	2	2	1.5	1.5	1.5																									
Z-40°C / Z+20°C	6	4	3	3	2	2	2																										
Z-55°C / Z+20°C	8	6	5	5	4	4	4																										
For Capacitance > 1000 µF, add 0.5 per another 1000 µF for -25°C / +20°C add 1 per another 1000 µF for -40°C / +20°C add 1.5 per another 1000 µF for -55°C / +20°C																																	
Endurance	Test conditions Duration time :as right Ambient temperature :+105°C Applied voltage :Rated DC working voltage After test requirement at +20°C Capacitance change :≤ ±20% of the initial measured value Dissipation factor :≤ 200% of the initial specified value Leakage current :≤ The initial specified value																																
	<table border="1"> <tr> <th>D φ</th> <th>Life hours</th> </tr> <tr> <td>5-6.3 φ</td> <td>2000</td> </tr> <tr> <td>8 φ</td> <td>3000</td> </tr> <tr> <td>≥ 10 φ</td> <td>6000</td> </tr> </table>	D φ	Life hours	5-6.3 φ	2000	8 φ	3000	≥ 10 φ	6000																								
D φ	Life hours																																
5-6.3 φ	2000																																
8 φ	3000																																
≥ 10 φ	6000																																
Shelf Life	Test conditions Duration time :1000Hrs Ambient temperature :+105°C Applied voltage :None After test requirement at +20°C: Same limits as Endurance. Pre-treatment for measurements shall be conducted after application of DC working voltage for 30 minutes.																																

Radial

Multiplier for Ripple Current vs. Frequency

CAP(µF)/Frequency(Hz)	50(60)	120	400	1K	10K	50K~100K
CAP ≤ 10	0.47	0.59	0.76	0.85	0.97	1.0
10 < CAP ≤ 100	0.52	0.65	0.80	0.89	0.97	1.0
100 < CAP ≤ 1000	0.58	0.72	0.84	0.90	0.98	1.0
1000 < CAP	0.63	0.78	0.87	0.91	0.98	1.0

Diagram of Dimensions:(unit:mm)

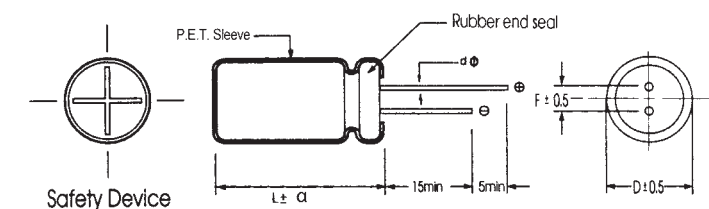

D φ	5	6.3	8	10	13	16	18	22
F	2.0	2.5	3.5	5.0	5.0	7.5	7.5	10
d φ	0.5		L < 20 0.5	L ≥ 20 0.6		0.6		0.8
	0.5		0.6		0.6		0.8	
α	D < 16		D = 16		D = 18		D > 18	
	L: 25~35.5		L < 25 and L ≥ 40		L: 25~31.5		L < 25 and L ≥ 35.5	
1.5		1.5		2.0		1.5		2.0

Case Size

WV (Vdc)	Cap (uF)	Size (mm)	Ripple current (mA rms/105°C /100KHz)	Max ESR(Ω) at 20°C/100KHz
6.3	100	5x11	185	0.950
6.3	120	5x11	190	0.900
6.3	150	6.3x11	210	0.750
6.3	180	6.3x11	240	0.700
6.3	220	6.3x11	300	0.550
6.3	270	6.3x11	310	0.490
6.3	330	6.3x15	320	0.340
6.3	330	8x11.5	390	0.300
6.3	470	6.3x15	435	0.250
6.3	470	8x11.5	430	0.220
6.3	560	8x11.5	480	0.200
6.3	680	8x11.5	510	0.180
6.3	820	8x16	620	0.140
6.3	1000	8x16	710	0.100
6.3	1000	10x12.5	625	0.120
6.3	1200	10x16	810	0.095
6.3	1500	10x16	1050	0.074
6.3	1800	10x20	1200	0.065
6.3	2200	10x20	1300	0.060
6.3	2200	10x25	1400	0.057
6.3	2700	10x25	1400	0.055
6.3	2700	13x20	1410	0.052
6.3	3300	13x20	1500	0.048
6.3	4700	13x25	1800	0.032
6.3	4700	13x30	1950	0.025
6.3	6800	13x30	2020	0.024
6.3	6800	16x25	2230	0.021
6.3	8200	16x31.5	2530	0.020
6.3	10000	16x35.5	2740	0.019
10	22	5x11	56	2.600
10	27	5x11	57	2.400
10	33	5x11	58	2.200
10	39	5x11	95	1.850
10	47	5x11	120	1.200
10	56	5x11	130	1.050
10	68	5x11	145	0.890
10	82	5x11	170	0.750
10	100	5x11	205	0.480
10	120	5x11	230	0.440
10	150	6.3x11	270	0.370
10	180	6.3x11	290	0.350
10	220	6.3x11	330	0.280
10	270	6.3x15	370	0.250
10	270	8x11.5	390	0.210
10	330	6.3x15	445	0.150
10	330	8x11.5	430	0.160
10	470	8x11.5	555	0.115
10	560	8x11.5	620	0.095
10	680	8x16	630	0.090
10	820	8x20	870	0.084
10	1000	8x20	1040	0.070
10	1000	10x16	1010	0.072
10	1200	10x16	1130	0.062
10	1500	10x20	1270	0.056
10	1800	10x25	1430	0.045
10	1800	13x20	1450	0.048
10	2200	13x20	1690	0.040
10	2700	13x20	1800	0.033
10	3300	13x25	1980	0.029
10	4700	13x30	2300	0.025
10	4700	16x25	2100	0.029
10	6800	16x31.5	2340	0.023
10	8200	16x35.5	2580	0.019
10	10000	18x31.5	2770	0.017
16	10	5x11	37	4.000
16	15	5x11	60	3.520

WV (Vdc)	Cap (uF)	Size (mm)	Ripple current (mA rms/105°C /100KHz)	Max ESR(Ω) at 20°C/100KHz
16	22	5x11	70	2.000
16	27	5x11	110	1.600
16	33	5x11	130	1.260
16	39	5x11	150	0.870
16	47	5x11	190	0.520
16	56	5x11	205	0.490
16	68	5x11	210	0.450
16	82	6.3x11	250	0.370
16	100	6.3x11	260	0.310
16	120	6.3x11	290	0.290
16	150	6.3x11	300	0.260
16	180	6.3x15	370	0.230
16	180	8x11.5	368	0.240
16	220	6.3x15	470	0.200
16	220	8x11.5	455	0.210
16	270	8x11.5	490	0.170
16	330	8x11.5	550	0.120
16	470	8x16	745	0.092
16	470	10x12.5	722	0.095
16	560	10x12.5	780	0.082
16	680	10x16	920	0.074
16	820	10x16	1020	0.067
16	1000	10x20	1180	0.050
16	1200	10x25	1370	0.047
16	1500	10x25	1470	0.041
16	1800	13x20	1630	0.038
16	2200	13x20	1800	0.035
16	2200	13x25	1950	0.033
16	2700	13x25	2050	0.031
16	3300	13x30	2410	0.025
16	3300	16x25	2340	0.028
16	4700	16x31.5	2650	0.022
16	4700	18x25	2570	0.024
16	6800	18x31.5	2700	0.020
16	8200	18x35.5	2830	0.018
16	10000	18x40	3300	0.015
25	10	5x11	56	2.100
25	15	5x11	97	1.950
25	22	5x11	120	1.800
25	27	5x11	130	1.560
25	33	5x11	150	1.200
25	39	5x11	170	0.820
25	47	5x11	220	0.500
25	56	5x11	245	0.440
25	68	6.3x11	270	0.390
25	82	6.3x11	285	0.330
25	100	6.3x11	300	0.280
25	120	6.3x11	350	0.220
25	150	6.3x15	420	0.200
25	180	6.3x15	440	0.180
25	180	8x11.5	435	0.190
25	220	8x11.5	550	0.125
25	270	8x11.5	620	0.095
25	330	8x16	740	0.085
25	330	10x12.5	720	0.082
25	470	10x16	1040	0.065
25	560	10x16	1070	0.061
25	680	10x20	1280	0.052
25	820	10x25	1460	0.043
25	1000	10x25	1530	0.039
25	1000	13x25	1580	0.038
25	1200	13x25	1800	0.036
25	1500	13x25	2020	0.032
25	1800	13x30	2300	0.027
25	2200	13x30	2480	0.025
25	2200	16x25	2405	0.027

WV (Vdc)	Cap (uF)	Size (mm)	Ripple current (mA rms/105°C /100KHz)	Max ESR(Ω) at 20°C/100KHz
25	2700	16x31.5	2670	0.024
25	3300	16x31.5	2960	0.020
25	3300	18x25	3050	0.022
25	4700	16x40	3490	0.022
25	4700	18x35.5	3520	0.021
25	6800	18x40	3600	0.017
35	10	5x11	70	1.900
35	15	5x11	115	1.720
35	22	5x11	130	1.360
35	27	5x11	140	1.200
35	33	5x11	175	0.950
35	39	6.3x11	200	0.740
35	47	6.3x11	250	0.440
35	56	6.3x11	270	0.400
35	68	6.3x11	300	0.350
35	82	6.3x15	350	0.290
35	100	6.3x15	390	0.180
35	100	8x11.5	380	0.190
35	120	8x11.5	460	0.170
35	150	8x16	580	0.150
35	180	8x16	630	0.130
35	220	8x16	740	0.095
35	220	10x12.5	720	0.098
35	270	8x20	830	0.086
35	270	10x16	840	0.088
35	330	10x16	995	0.065
35	470	10x20	1150	0.050
35	560	10x25	1310	0.048
35	680	13x20	1440	0.044
35	820	13x20	1600	0.038
35	1000	13x30	1950	0.036
35	1200	16x25	2200	0.029
35	1500	16x31.5	2520	0.027
35	1800	16x31.5	2560	0.026
35	2200	16x31.5	2650	0.025
35	2200	18x25	2570	0.026
35	2700	18x31.5	2660	0.023
35	3300	18x35.5	3000	0.020
35	4700	18x40	3000	0.019
50	0.47	5x11	15	5.000
50	1	5x11	25	3.950
50	2.2	5x11	33	2.600
50	3.3	5x11	45	2.000
50	4.7	5x11	58	1.890
50	5.6	5x11	80	1.850
50	6.8	5x11	85	1.770
50	8.2	5x11	90	1.720
50	10	5x11	100	1.700
50	15	5x11	110	1.530
50	22	6.3x11	135	1.000
50	27	6.3x11	160	0.930
50	33	6.3x11	230	0.740
50	39	6.3x11	240	0.650
50	47	8x11.5	285	0.500
50	56	8x11.5	300	0.390
50	68	8x11.5	340	0.300

WV (Vdc)	Cap (uF)	Size (mm)	Ripple current (mA rms/105°C /100KHz)	Max ESR(Ω) at 20°C/100KHz
50	82	8x11.5	400	0.250
50	100	8x16	475	0.180
50	120	8x16	520	0.170
50	150	10x16	675	0.130
50	180	10x16	760	0.095
50	220	10x20	900	0.085
50	270	10x20	950	0.075
50	330	10x25	1050	0.068
50	470	13x20	1490	0.048
50	560	13x20	1550	0.045
50	680	13x25	1840	0.041
50	820	13x30	2060	0.036
50	1000	13x40	2200	0.033
50	1000	16x31.5	2130	0.030
50	1200	16x31.5	2520	0.027
50	1500	16x35.5	2700	0.026
50	1800	18x31.5	2800	0.025
50	2200	18x35.5	2900	0.024
50	2700	18x40	2970	0.021
63	0.47	5x11	16	5.000
63	1	5x11	27	3.950
63	2.2	5x11	38	2.600
63	3.3	5x11	48	2.000
63	4.7	5x11	62	1.890
63	5.6	5x11	85	1.820
63	6.8	5x11	90	1.750
63	8.2	5x11	100	1.690
63	10	5x11	105	1.650
63	15	5x11	110	1.470
63	22	6.3x11	170	0.800
63	27	6.3x11	190	0.750
63	33	8x11.5	245	0.610
63	39	8x11.5	270	0.580
63	47	8x11.5	290	0.560
63	56	8x11.5	320	0.380
63	68	8x16	480	0.300
63	82	8x16	510	0.280
63	100	10x16	590	0.240
63	120	10x16	660	0.160
63	150	10x20	790	0.110
63	180	10x20	850	0.095
63	220	10x25	1020	0.082
63	220	13x20	1024	0.080
63	270	13x20	1100	0.072
63	330	10x30	1200	0.064
63	330	13x25	1160	0.067
63	470	16x25	1750	0.048
63	560	16x25	1830	0.044
63	680	16x31.5	2070	0.040
63	820	16x31.5	2100	0.035
63	1000	16x35.5	2450	0.031
63	1200	18x31.5	2500	0.026
63	1500	18x35.5	2700	0.025
63	1800	18x40	2900	0.024
63	2200	18x40	2990	0.023

KF Series Low Impedance

Features

- ◆ Used in communication equipments, switching power supply, industrial measuring instruments, etc.
- ◆ Endurance 2000~5000 Hrs at 105°C
- ◆ Safety vent construction design.
- ◆ RoHS Compliant



Specifications

Item	Performance Characteristics							
Operating Temperature Range	-40 to +105°C	-25 to +105°C						
Rated Voltage Range	6.3 to 100 VDC	160 to 450 VDC						
Capacitance Range	0.47 to 15000 µF	0.47 to 470 µF						
Capacitance Tolerance	±20%(120Hz,+20°C)							
Leakage Current (+20°C,max.)	I ≤ 0.01 CV or 3 (µA)	I ≤ 0.03 CV (µA)						
	After 2 minutes whichever is greater measured with rated working voltage applied.	After 2 minutes with rate working voltage applied.						
Dissipation Factor (tan δ , at 20°C , 120Hz)	Working Voltage(VDC)	6.3 10 16 25 35 50 63 100						
	D.F. (%)max.	18 16 14 12 10 9 8 8						
	Working Voltage(VDC)	160 200 250 350 400 420 450						
	D.F. (%)max.	12 12 12 15 15 17 17						
For capacitance > 1000 µF, add 2% per another 1000uF.								
Low Temperature Characteristics (at 120Hz)	Impedance ratio max							
	Working Voltage(VDC)	6.3 10 16 25 35 50 63 100						
	Z-25°C / Z+20°C	4 3 3 3 3 3 2 2						
	Z-40°C / Z+20°C	8 6 4 3 3 3 3 3						
	Working Voltage(VDC)	160 200 250 350 400 450						
	Z-25°C / Z+20°C	2 2 3 5 5 6						
Z-40°C / Z+20°C	3 6 6 6 6 -							
For capacitance > 1000 µF, add 0.5 per another 1000uF for -25°C / +20°C add 1 per another 1000uF for -40°C / +20°C								
Endurance	Test conditions		D φ	Life hours				
	Duration time : as right	Ambient temperature : +105°C	5-6.3 φ	2000				
Applied voltage : Rated DC working voltage		8 φ	3000					
After test requirement at +20°C		≥ 10 φ	5000					
Capacitance change : ≤ ±20% of the initial measured value		(160-450V : 2000hrs)						
Dissipation factor : ≤ 200% of the initial specified value								
Leakage current : ≤ The initial specified value								
Shelf Life	Test conditions							
	Duration time : 1000Hrs	Ambient temperature : +105°C						
	Applied voltage : None							
	After test requirement at +20°C: Same limits as Endurance.							
Pre-treatment for measurements shall be conducted after application of DC working voltage for 30 minutes.								

Radial

Multiplier for Ripple Current vs. Frequency

CAP(µF)/Frequency(Hz)	50(60)	120	400	1K	10K	50K~100K
CAP ≤ 10	0.47	0.59	0.76	0.85	0.97	1.0
10 < CAP ≤ 100	0.52	0.65	0.80	0.89	0.97	1.0
100 < CAP ≤ 1000	0.58	0.72	0.84	0.90	0.98	1.0
1000 < CAP	0.63	0.78	0.87	0.91	0.98	1.0

Diagram of Dimensions:(unit:mm)

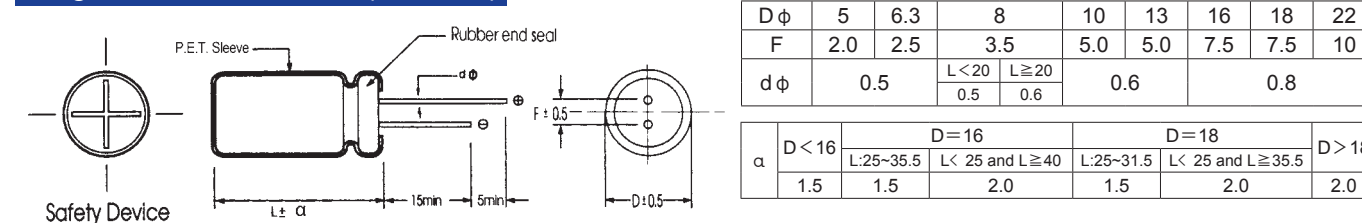

Case Size

WV (Vdc)	Cap (uF)	Size (mm)	Ripple current (mA _{rms} /105°C /100KHz)	Max ESR(Ω) at 20°C/100KHz
6.3	100	5x11	170	1.00
6.3	120	5x11	175	0.92
6.3	150	6.3x11	220	0.81
6.3	150	5x11	185	0.90
6.3	180	6.3x11	240	0.76
6.3	220	6.3x11	310	0.65
6.3	270	6.3x11	340	0.54
6.3	330	8x11.5	390	0.42
6.3	470	8x11.5	450	0.25
6.3	560	8x11.5	490	0.23
6.3	680	8x11.5	550	0.21
6.3	820	8x16	620	0.20
6.3	1000	10x12.5	770	0.17
6.3	1000	8x16	750	0.18
6.3	1200	10x16	860	0.16
6.3	1500	10x16	1100	0.14
6.3	1800	10x20	1250	0.11
6.3	2200	10x20	1380	0.090
6.3	2200	10x25	1470	0.095
6.3	2700	10x25	1490	0.075
6.3	2700	13x20	1550	0.075
6.3	3300	13x20	1650	0.036
6.3	4700	13x30	2100	0.036
6.3	4700	13x25	1900	0.040
6.3	5600	13x30	2160	0.034
6.3	6800	16x25	2350	0.032
6.3	8200	16x31.5	2550	0.027
6.3	10000	16x35.5	2700	0.024
6.3	15000	18x35.5	2950	0.023
10	22	5x11	98	2.700
10	33	5x11	100	2.600
10	47	5x11	150	1.340
10	56	5x11	160	1.230
10	68	5x11	170	1.050
10	100	5x11	210	0.800
10	120	6.3x11	250	0.750
10	150	6.3x11	290	0.610
10	180	6.3x11	320	0.460
10	220	6.3x11	340	0.350
10	270	8x11.5	400	0.300
10	330	8x11.5	460	0.270
10	470	8x11.5	580	0.250
10	560	10x12.5	635	0.160
10	560	8x11.5	550	0.170
10	680	10x12.5	765	0.110
10	820	10x16	890	0.100
10	1000	10x16	1040	0.076
10	1200	10x16	1200	0.067
10	1500	10x20	1400	0.062
10	1800	10x25	1550	0.058
10	2200	13x20	1750	0.041
10	2200	10x25	1650	0.052
10	2700	13x20	1900	0.035
10	3300	13x25	2000	0.031
10	4700	16x25	2100	0.030
10	5600	16x25	2290	0.028
10	6800	16x31.5	2650	0.026
10	8200	16x35.5	2770	0.026
10	10000	18x35.5	2850	0.024

WV (Vdc)	Cap (uF)	Size (mm)	Ripple current (mA _{rms} /105°C /100KHz)	Max ESR(Ω) at 20°C/100KHz
16	10	5x11	74	4.700
16	22	5x11	100	2.60
16	33	5x11	114	2.00
16	47	5x11	155	1.10
16	56	5x11	180	0.82
16	68	5x11	195	0.69
16	100	6.3x11	265	0.50
16	120	6.3x11	270	0.47
16	150	6.3x11	290	0.41
16	180	8x11.5	370	0.34
16	180	6.3x11	315	0.38
16	220	8x11.5	480	0.25
16	270	8x11.5	520	0.21
16	330	8x11.5	590	0.156
16	470	10x12.5	750	0.124
16	560	10x12.5	785	0.105
16	680	10x16	1100	0.092
16	820	10x16	1180	0.078
16	1000	10x20	1350	0.065
16	1200	10x25	1500	0.061
16	1500	10x30	1600	0.056
16	1500	13x20	1380	0.060
16	1800	13x20	1800	0.047
16	1800	10x25	1730	0.050
16	2200	13x25	2000	0.038
16	2200	13x20	1880	0.040
16	2700	13x25	2450	0.033
16	3300	16x25	2790	0.030
16	3300	13x30	2640	0.030
16	4700	16x31.5	2880	0.026
16	5600	16x35.5	2990	0.025
16	6800	18x35.5	3200	0.024
16	8200	18x35.5	3320	0.024
16	10000	18x40	3550	0.024
25	4.7	5x11	68	3.950
25	5.6	5x11	75	3.250
25	6.8	5x11	80	2.980
25	10	5x11	85	2.560
25	22	5x11	125	1.950
25	33	5x11	155	1.420
25	47	5x11	190	1.100
25	47	6.3x11	220	1.000
25	56	6.3x11	250	0.790
25	68	6.3x11	280	0.650
25	100	6.3x11	370	0.350
25	120	6.3x11	380	0.330
25	150	8x11.5	410	0.310
25	180	8x11.5	455	0.250
25	220	8x11.5	550	0.150
25	270	10x12.5	720	0.125
25	330	10x12.5	820	0.114
25	470	10x16	1200	0.076
25	560	10x16	1250	0.072
25	680	10x20	1320	0.065
25	820	10x20	1400	0.052
25	820	10x25	1530	0.052
25	1000	13x20	1650	0.045
25	1200	13x25	1980	0.041
25	1500	13x25	2210	0.038

WV (Vdc)	Cap (uF)	Size (mm)	Ripple current (mA _{rms} /105°C /100KHz)	Max ESR(Ω) at 20°C/100KHz
25	1800	16x25	2510	0.036
25	2200	16x25	2650	0.035
25	2700	16x25	2820	0.031
25	3300	16x31.5	3240	0.026
25	4700	16x35.5	3650	0.024
25	5600	18x35.5	3720	0.024
25	6800	18x40	3850	0.024
35	4.7	5x11	85	3.650
35	5.6	5x11	92	3.090
35	6.8	5x11	97	2.820
35	10	5x11	105	2.370
35	22	5x11	150	1.500
35	33	5x11	180	1.210
35	47	6.3x11	280	0.800
35	56	6.3x11	310	0.640
35	68	8x11.5	350	0.520
35	100	8x11.5	450	0.250
35	120	8x11.5	510	0.220
35	150	8x11.5	540	0.191
35	180	10x12.5	650	0.172
35	220	10x12.5	750	0.114
35	270	10x16	910	0.095
35	330	10x16	1050	0.079
35	470	10x20	1200	0.065
35	560	10x25	1500	0.061
35	680	13x20	1570	0.056
35	820	13x20	1700	0.048
35	1000	13x25	1900	0.042
35	1200	13x30	2130	0.039
35	1500	16x25	2270	0.036
35	1800	16x31.5	2700	0.035
35	2200	16x31.5	2780	0.034
35	2700	16x35.5	2850	0.029
35	3300	18x35.5	3100	0.026
35	4700	18x40	3500	0.024
50	0.47	5x11	25	5.400
50	1	5x11	40	4.000
50	2.2	5x11	55	2.800
50	3.3	5x11	60	2.200
50	4.7	5x11	90	2.000
50	5.6	5x11	105	1.930
50	6.8	5x11	110	1.890
50	10	5x11	120	1.820
50	22	6.3x11	150	1.250
50	33	6.3x11	250	0.800
50	47	6.3x11	290	0.650
50	56	8x11.5	310	0.490
50	68	8x11.5	375	0.330
50	100	10x12.5	480	0.170
50	120	10x12.5	530	0.156
50	150	10x12.5	590	0.132
50	180	10x16	860	0.114
50	220	10x16	930	0.096
50	270	10x20	1060	0.078
50	330	10x25	1150	0.065
50	470	13x20	1590	0.055
50	560	13x20	1740	0.050
50	680	13x25	1930	0.044
50	820	13x30	2100	0.039
50	1000	16x25	2300	0.036
50	1200	16x31.5	2650	0.036

WV (Vdc)	Cap (uF)	Size (mm)	Ripple current (mA _{rms} /105°C /100KHz)	Max ESR(Ω) at 20°C/100KHz
50	1500	16x35.5	2750	0.034
50	1800	16x35.5	2850	0.034
50	2200	18x35.5	3040	0.032
50	2700	18x40	3070	0.027
50	3300	18x40	3100	0.025
63	0.47	5x11	25	5.400
63	1	5x11	33	4.000
63	2.2	5x11	45	2.800
63	3.3	5x11	58	2.200
63	4.7	5x11	65	2.000
63	5.6	5x11	95	1.900
63	6.8	5x11	100	1.820
63	10	5x11	110	1.750
63	22	6.3x11	180	0.800
63	33	8x11.5	270	0.610
63	47	8x11.5	300	0.560
63	56	8x11.5	330	0.380
63	68	10x12.5	480	0.210
63	100	10x16	610	0.140
63	120	10x16	620	0.130
63	150	10x16	700	0.110
63	180	10x20	800	0.100
63	220	10x20	920	0.080
63	270	13x20	1150	0.065
63	330	13x20	1250	0.055
63	470	13x25	1620	0.053
63	560	13x25	1680	0.049
63	680	13x30	1950	0.043
63	820	16x25	2150	0.038
63	1000	16x31.5	2350	0.034
63	1200	16x35.5	2550	0.032
63	1500	18x35.5	2710	0.031
63	1800	18x40	3000	0.027
80	0.47	5x11	18	5.850
80	1	5x11	24	4.300
80	2.2	5x11	36	3.200
80	3.3	5x11	47	2.700
80	4.7	5x11	63	2.500
80	5.6	5x11	85	2.300
80	6.8	5x11	92	1.850
80	10	5x11	105	1.700
80	22	6.3x11	175	0.830
80	33	8x11.5	280	0.610
80	47	8x11.5	310	0.550
80	56	8x11.5	360	0.410
80	68	8x16	400	0.280
80	100	8x20	500	0.220
80	120	10x16	580	0.180
80	150	10x20	680	0.150
80	180	10x20	800	0.112
80	220	13x20	900	0.090
80	270	13x20	1080	0.095
80	330	13x25	1210	0.085
80	470	16x25	1500	0.070
80	560	16x25	1640	0.062
80	680	18x25	1680	0.059
80	820	18x31.5	1780	0.056
80	1000	18x31.5	1850	0.045
80	1200	18x35.5	1960	0.042
80	1500	18x40	2160	0.036
100	0.47	5x11	20	5.900

WV (Vdc)	Cap (uF)	Size (mm)	Ripple current (mA rms/105°C /100KHz)	Max ESR(Ω) at 20°C/100KHz
100	1	5x11	30	4.400
100	2.2	5x11	42	3.300
100	3.3	5x11	55	2.800
100	4.7	5x11	72	2.600
100	5.6	5x11	100	2.330
100	6.8	6.3x11	115	1.950
100	10	6.3x11	130	1.770
100	22	8x11.5	220	0.850
100	33	10x12.5	320	0.690
100	47	10x12.5	370	0.580
100	56	10x12.5	400	0.430
100	56	10x16	440	0.420
100	68	10x16	470	0.350
100	100	10x25	560	0.300
100	120	10x25	660	0.220
100	150	13x20	780	0.174
100	180	13x20	820	0.142
100	220	13x25	950	0.130
100	270	13x30	1120	0.110
100	330	16x25	1440	0.100
100	470	16x31.5	1650	0.090
100	560	16x35.5	1720	0.085
100	680	18x35.5	1790	0.080
100	820	18x35.5	1840	0.071
100	1000	18x40	1930	0.066
160	0.47	5x11	36	18.500
160	1	6.3x11	45	12.000
160	2.2	6.3x11	55	9.90
160	3.3	8x11.5	70	4.31
160	4.7	8x11.5	80	4.16
160	5.6	10x12.5	91	3.61
160	6.8	10x16	100	3.12
160	10	10x12.5	126	3.00
160	10	10x16	140	2.69
160	22	10x16	205	1.30
160	33	10x20	260	1.10
160	47	10x20	276	1.65
160	47	13x20	320	0.91
160	56	13x20	340	0.67
160	56	13x25	370	0.66
160	68	13x25	450	0.56
160	100	16x25	540	0.47
160	120	16x25	560	0.35
160	150	16x31.5	710	0.26
160	180	16x35.5	760	0.22
160	220	16x35.5	820	0.19
160	270	18x35.5	990	0.18
160	330	18x40	1180	0.16
200	0.47	5x11	36	16.50
200	0.47	6.3x11	41	16.50
200	1	6.3x11	45	7.76
200	2.2	6.3x11	55	5.18
200	3.3	8x11.5	71	4.25
200	4.7	8x11.5	78	5.00
200	4.7	10x12.5	85	4.12
200	5.6	8x11.5	90	4.50
200	5.6	10x12.5	95	3.55
200	6.8	8x16	115	3.25
200	6.8	10x16	140	2.71
200	10	8x11.5	115	3.75
200	10	10x16	150	2.02

WV (Vdc)	Cap (uF)	Size (mm)	Ripple current (mA rms/105°C /100KHz)	Max ESR(Ω) at 20°C/100KHz
200	22	10x16	186	1.80
200	22	10x20	205	1.40
200	33	10x20	280	1.00
200	33	13x20	330	0.80
200	47	10x20	311	0.72
200	47	13x20	360	0.65
200	47	13x25	400	0.62
200	56	13x20	430	0.45
200	68	13x25	480	0.42
200	68	16x25	540	0.35
200	68	16x25	780	0.30
200	100	16x31.5	820	0.28
200	120	16x25	740	0.28
200	120	16x31.5	830	0.26
200	150	16x31.5	840	0.25
200	150	16x35.5	860	0.23
200	180	18x31.5	920	0.20
200	220	18x35.5	1050	0.19
200	220	18x40	1090	0.16
250	0.47	5x11	40	8.85
250	1	6.3x11	50	6.54
250	2.2	8x11.5	72	4.12
250	3.3	8x11.5	75	3.85
250	4.7	8x11.5	85	3.50
250	4.7	10x12.5	100	2.95
250	5.6	8x11.5	95	2.93
250	5.6	10x12.5	105	2.90
250	6.8	8x16	124	2.80
250	6.8	10x12.5	126	2.80
250	6.8	10x16	140	1.86
250	10	8x16	141	1.80
250	10	10x12.5	144	1.75
250	10	10x16	160	1.40
250	22	10x16	190	1.60
250	22	10x20	210	1.30
250	33	10x20	224	1.40
250	33	10x25	248	1.25
250	33	13x20	310	0.90
250	47	13x20	375	0.60
250	47	13x25	405	0.45
250	56	13x25	420	0.42
250	68	16x25	490	0.38
250	68	16x31.5	675	0.27
250	120	16x31.5	692	0.26
250	120	16x35.5	730	0.25
250	150	16x35.5	750	0.24
250	150	18x31.5	750	0.23
250	180	18x35.5	830	0.21
250	220	18x31.5	850	0.20
250	220	18x40	910	0.19
350	0.47	6.3x11	40	8.82
350	1	6.3x11.5	50	7.90
350	1	6.3x11	58	6.35
350	2.2	8x11.5	75	5.30
350	2.2	10x12.5	86	4.02
350	3.3	10x12.5	90	3.80
350	3.3	10x16	100	3.52
350	4.7	10x16	118	3.13
350	4.7	10x20	130	2.77
350	5.6	10x16	120	2.76
350	5.6	10x20	132	2.58

WV (Vdc)	Cap (uF)	Size (mm)	Ripple current (mA _{rms} /105°C /100KHz)	Max ESR(Ω) at 20°C/100KHz
350	6.8	10x16	148	2.43
350	6.8	10x25	180	1.65
350	10	10x16	165	1.64
350	10	10x25	200	1.35
350	22	13x20	220	1.22
350	33	13x20	263	1.02
350	33	13x25	290	0.86
350	47	16x25	389	0.76
350	47	16x31.5	430	0.62
350	56	16x35.5	460	0.60
350	68	16x31.5	475	0.57
350	68	16x35.5	481	0.56
350	100	18x31.5	487	0.56
350	100	18x35.5	513	0.55
350	120	18x35.5	525	0.54
350	120	18x40	560	0.52
350	150	18x40	590	0.50
400	0.47	6.3x11	26	33.0
400	1	8x11.5	36	16.5
400	2.2	10x12.5	76	13.0
400	2.2	8x11.5	65	13.0
400	3.3	8x9	78	14.0
400	3.3	8x11.5	86	12.0
400	4.7	8x11.5	89	11.0
400	4.7	10x12.5	105	10.0
400	5.6	8x16	105	8.0
400	5.6	10x12.5	120	9.0
400	6.8	10x12.5	144	7.7
400	6.8	10x16	160	7.5
400	10	10x14	201	5.0
400	10	10x16	213	3.8
400	10	10x20	235	3.6
400	15	10x20	240	3.0
400	22	13x16	268	2.8
400	22	13x20	295	2.7
400	33	13x20	399	1.8
400	33	13x25	440	1.6
400	33	16x20	459	1.9
400	47	16x20	539	1.6
400	47	16x25	580	1.4
400	56	16x25	587	1.03

WV (Vdc)	Cap (uF)	Size (mm)	Ripple current (mA _{rms} /105°C /100KHz)	Max ESR(Ω) at 20°C/100KHz
400	56	16x31.5	650	0.85
400	68	16x31.5	800	0.80
400	68	18x25	774	0.76
400	100	18x31.5	854	0.70
400	100	18x35.5	900	1.30
400	120	18x35.5	930	1.30
420	0.47	6.3x11	28	34.00
420	1	8x11.5	38	17.00
420	2.2	10x12.5	58	12.10
420	3.3	10x12.5	87	11.00
420	4.7	10x16	102	8.50
420	5.6	10x16	109	6.80
420	6.8	10x16	160	6.00
420	10	10x20	180	3.70
420	22	13x25	330	2.70
420	33	16x25	480	1.80
420	47	16x31.5	620	1.10
420	56	16x35.5	670	0.90
420	68	18x31.5	750	0.80
420	100	18x35.5	820	0.70
450	0.47	8x11.5	30	34.00
450	1	8x11.5	45	17.35
450	2.2	10x16	65	10.250
450	3.3	10x16	89	10.00
450	4.7	10x20	105	5.00
450	5.6	10x20	110	4.75
450	6.8	10x20	135	4.05
450	10	10x20	163	7.00
450	10	10x25	180	3.75
450	10	13x20	189	6.80
450	22	13x25	320	2.80
450	33	16x25	460	2.20
450	33	18x20	458	2.70
450	47	16x35.5	650	1.05
450	47	18x25	596	1.65
450	56	18x31.5	730	0.95
450	68	18x31.5	721	0.80
450	68	18x35.5	760	0.75
450	100	18x35.5	825	1.10
450	100	18x40	880	0.74
450	120	18x40	980	1.00

KZ Series Low Impedance

Features

- ◆ Used in communication equipments, switching power supply, industrial measuring instruments, etc.
- ◆ Endurance 1000~2000hrs.
- ◆ Safety vent construction design.
- ◆ RoHS Compliant



Specifications

Item	Performance Characteristics																					
Operating Temperature Range	-40 to +105°C																					
Rated Voltage Range	6.3 to 50 VDC																					
Capacitance Range	0.47 to 6800 μF																					
Capacitance Tolerance	±20%(120Hz,+20°C)																					
Leakage Current (+20°C,max.)	$I \leq 0.01 CV$ or $3 (\mu A)$ After 2 minutes whichever is greater measured with rated working voltage applied.																					
Dissipation Factor ($\tan \delta$ · at 20°C · 120Hz)	<table border="1"> <tr> <td>Working Voltage(VDC)</td> <td>6.3</td> <td>10</td> <td>16</td> <td>25</td> <td>35</td> <td>50</td> </tr> <tr> <td>D.F. (%)max.</td> <td>18</td> <td>16</td> <td>14</td> <td>12</td> <td>10</td> <td>9</td> </tr> </table>	Working Voltage(VDC)	6.3	10	16	25	35	50	D.F. (%)max.	18	16	14	12	10	9							
	Working Voltage(VDC)	6.3	10	16	25	35	50															
D.F. (%)max.	18	16	14	12	10	9																
For capacitance > 1000 μF, add 2% per another 1000uF.																						
Low Temperature Characteristics (at 120Hz)	Impedance ratio max																					
	<table border="1"> <tr> <td>Working Voltage(VDC)</td> <td>6.3</td> <td>10</td> <td>16</td> <td>25</td> <td>35</td> <td>50</td> </tr> <tr> <td>Z-25°C / Z+20°C</td> <td>4</td> <td>3</td> <td>3</td> <td>3</td> <td>3</td> <td>3</td> </tr> <tr> <td>Z-40°C / Z+20°C</td> <td>8</td> <td>6</td> <td>4</td> <td>3</td> <td>3</td> <td>3</td> </tr> </table>	Working Voltage(VDC)	6.3	10	16	25	35	50	Z-25°C / Z+20°C	4	3	3	3	3	3	Z-40°C / Z+20°C	8	6	4	3	3	3
	Working Voltage(VDC)	6.3	10	16	25	35	50															
Z-25°C / Z+20°C	4	3	3	3	3	3																
Z-40°C / Z+20°C	8	6	4	3	3	3																
For capacitance > 1000 μF, add 0.5 per another 1000uF for -25°C / +20°C add 1 per another 1000uF for -40°C / +20°C																						
Endurance	Test conditions Duration time : as right Ambient temperature : +105°C Applied voltage : Rated DC working voltage																					
	<table border="1"> <tr> <td>D φ</td> <td>Life hours</td> </tr> <tr> <td>5-6.3 φ</td> <td>1000</td> </tr> <tr> <td>≥ 8 φ</td> <td>2000</td> </tr> </table>	D φ	Life hours	5-6.3 φ	1000	≥ 8 φ	2000															
D φ	Life hours																					
5-6.3 φ	1000																					
≥ 8 φ	2000																					
After test requirement at +20°C Capacitance change : ≤ ±20% of the initial measured value Dissipation factor : ≤ 200% of the initial specified value Leakage current : ≤ The initial specified value																						
Shelf Life	Test conditions Duration time : 1000Hrs Ambient temperature : +105°C Applied voltage : None																					
	After test requirement at +20°C: Same limits as Endurance. Pre-treatment for measurements shall be conducted after application of DC working voltage for 30 minutes.																					

Multiplier for Ripple Current vs. Frequency

CAP(μF)/Frequency(Hz)	50(60)	120	400	1K	10K	50K~100K
CAP ≤ 10	0.47	0.59	0.76	0.85	0.97	1.0
10 < CAP ≤ 100	0.52	0.65	0.80	0.89	0.97	1.0
100 < CAP ≤ 1000	0.58	0.72	0.84	0.90	0.98	1.0
1000 < CAP	0.63	0.78	0.87	0.91	0.98	1.0

Diagram of Dimensions:(unit:mm)

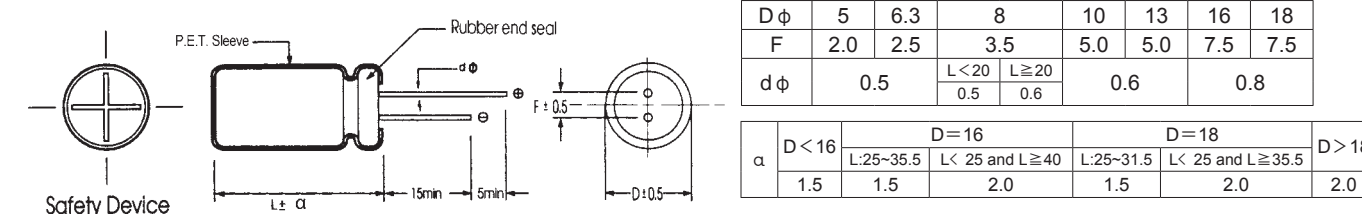

Case Size

WV (Vdc)	Cap (uF)	Size (mm)	Ripple current (mAmps/105°C /100KHz)	Max ESR(Ω) at 20°C/100KHz
6.3	22	5x11	80	3.00
6.3	33	5x11	90	2.00
6.3	47	5x11	140	1.50
6.3	56	5x11	150	1.50
6.3	68	5x11	160	1.10
6.3	100	5x11	170	1.00
6.3	120	5x11	173	0.90
6.3	150	5x11	178	0.85
6.3	180	6.3x11	215	0.72
6.3	220	6.3x11	295	0.62
6.3	270	6.3x11	320	0.50
6.3	330	6.3x11	380	0.45
6.3	470	8x11.5	460	0.22
6.3	560	8x11.5	490	0.22
6.3	680	8x11.5	520	0.19
6.3	820	8x11.5	605	0.19
6.3	1000	8x11.5	680	0.18
6.3	1200	10x12.5	750	0.15
6.3	1500	10x12.5	820	0.14
6.3	1800	10x16	920	0.12
6.3	2200	10x20	1150	0.10
6.3	2700	10x20	1500	0.075
6.3	3300	10x20	1620	0.060
6.3	3900	13x25	1820	0.058
6.3	4700	13x25	1920	0.040
6.3	5600	13x30	2210	0.038
6.3	6800	16x25	2380	0.032
10	22	5x11	90	2.50
10	33	5x11	105	2.00
10	47	5x11	155	1.30
10	56	5x11	165	1.20
10	68	5x11	175	1.00
10	100	5x11	215	0.75
10	120	6.3x11	240	0.73
10	150	6.3x11	225	0.60
10	180	6.3x11	280	0.58
10	220	6.3x11	300	0.43
10	270	8x11.5	405	0.28
10	330	8x11.5	465	0.25
10	470	8x11.5	500	0.22
10	560	8x11.5	620	0.17
10	680	8x11.5	750	0.12
10	820	10x12.5	805	0.10
10	1000	10x12.5	1050	0.08
10	1200	10x16	1150	0.065
10	1500	10x16	1210	0.062
10	1800	10x20	1280	0.060
10	2200	10x20	1520	0.050
10	2700	13x20	1580	0.048
10	3300	13x20	1700	0.043
10	3900	13x25	1860	0.040
10	4700	13x25	1950	0.038
10	5600	16x25	2290	0.033
10	6800	16x25	2480	0.028
16	10	5x11	80	4.00
16	22	5x11	110	2.00
16	33	5x11	114	1.80
16	47	5x11	160	1.00
16	56	5x11	180	0.80

WV (Vdc)	Cap (uF)	Size (mm)	Ripple current (mAmps/105°C /100KHz)	Max ESR(Ω) at 20°C/100KHz
16	68	5x11	200	0.65
16	100	5x11	255	0.55
16	120	6.3x11	270	0.45
16	150	6.3x11	292	0.40
16	180	6.3x11	380	0.32
16	220	6.3x11	430	0.25
16	270	8x11.5	480	0.20
16	330	8x11.5	595	0.15
16	470	8x11.5	650	0.15
16	560	8x11.5	730	0.12
16	680	10x12.5	890	0.09
16	820	10x12.5	980	0.085
16	1000	10x16	1180	0.070
16	1200	10x20	1320	0.060
16	1500	10x20	1450	0.056
16	1800	10x20	1510	0.053
16	2200	13x20	1820	0.040
16	2700	13x20	2050	0.035
16	3300	13x25	2300	0.033
16	3900	16x25	2550	0.033
16	4700	16x25	2580	0.032
16	5600	16x31.5	2650	0.030
16	6800	16x31.5	2900	0.024
25	4.7	5x11	72	3.50
25	5.6	5x11	75	3.50
25	6.8	5x11	83	2.80
25	10	5x11	87	2.50
25	22	5x11	118	1.80
25	33	5x11	155	1.40
25	47	5x11	183	0.90
25	56	5x11	207	0.83
25	68	5x11	210	0.69
25	100	6.3x11	378	0.34
25	120	6.3x11	380	0.33
25	150	8x11.5	390	0.325
25	180	8x11.5	430	0.25
25	220	8x11.5	550	0.15
25	270	8x11.5	520	0.15
25	330	8x11.5	710	0.13
25	470	8x11.5	980	0.078
25	470	8x16	1050	0.070
25	560	10x16	1080	0.065
25	680	10x16	1100	0.065
25	820	10x20	1350	0.050
25	1000	10x20	1580	0.045
25	1200	13x20	1720	0.040
25	1500	13x20	1780	0.040
25	1800	13x20	1980	0.035
25	2200	13x25	2000	0.033
25	2700	13x25	2250	0.032
25	3300	16x25	2580	0.027
25	4700	16x31.5	2850	0.025
25	5600	16x35.5	3000	0.025
25	6800	18x35.5	3550	0.025
35	4.7	5x11	87	3.50
35	5.6	5x11	95	3.00
35	6.8	5x11	98	2.70
35	10	5x11	107	2.20
35	22	5x11	150	1.50

WV (Vdc)	Cap (uF)	Size (mm)	Ripple current (mArms/105°C /100KHz)	Max ESR(Ω) at 20°C/100KHz
35	33	5x11	180	1.20
35	47	5x11	257	0.75
35	56	6.3x11	283	0.60
35	68	6.3x11	290	0.55
35	100	6.3x11	430	0.26
35	120	8x11.5	470	0.20
35	150	8x11.5	510	0.20
35	180	8x11.5	570	0.18
35	220	8x11.5	620	0.13
35	270	10x12.5	850	0.12
35	330	8x16	1050	0.08
35	470	10x16	1100	0.065
35	560	13x20	1300	0.060
35	680	13x20	1570	0.056
35	820	13x20	1700	0.048
35	1000	13x20	1820	0.042
35	1200	13x25	2130	0.038
35	1500	13x25	2150	0.038
35	1800	13x25	2450	0.035
35	2200	16x25	2650	0.034
35	2700	16x31.5	2690	0.030
35	3300	16x35.5	2750	0.027
35	4700	18x35.5	2940	0.025
35	5600	18x35.5	3050	0.024
50	0.47	5x11	28	5.00
50	1	5x11	42	3.80
50	2.2	5x11	55	2.80
50	3.3	5x11	62	2.00

WV (Vdc)	Cap (uF)	Size (mm)	Ripple current (mArms/105°C /100KHz)	Max ESR(Ω) at 20°C/100KHz
50	4.7	5x11	90	2.00
50	5.6	5x11	108	1.80
50	6.8	5x11	112	1.80
50	10	5x11	120	1.75
50	22	5x11	150	1.50
50	33	6.3x11	233	0.78
50	47	6.3x11	270	0.65
50	56	6.3x11	290	0.60
50	68	6.3x11	310	0.50
50	100	8x11.5	480	0.17
50	120	10x12.5	500	0.164
50	150	10x12.5	560	0.16
50	180	10x12.5	580	0.14
50	220	10x16	640	0.09
50	270	10x16	905	0.08
50	330	10x16	1050	0.07
50	470	13x20	1450	0.05
50	560	13x20	1510	0.05
50	680	13x20	1750	0.05
50	820	13x25	1980	0.04
50	1000	13x25	2000	0.04
50	1200	16x25	2200	0.038
50	1500	16x25	2300	0.038
50	1800	16x31.5	2610	0.036
50	2200	16x31.5	2900	0.033
50	2700	18x35.5	3000	0.028
50	3300	18x35.5	3050	0.026

GF Series Low Impedance

Features

- ◆ Used in mother board, computer peripheral, etc.
- ◆ Endurance 2000 ~ 5000 Hrs at 105 °C
- ◆ Safety vent construction design.
- ◆ RoHS Compliant



Specifications

Item	Performance Characteristics									
Operating Temperature Range	-55 to +105°C									
Rated Voltage Range	6.3 to 100 VDC									
Capacitance Range	4.7 to 6800 μF									
Capacitance Tolerance	±20% (120Hz, +20°C)									
Leakage Current (+20°C, max.)	I ≤ 0.01 CV or 3 (μA) After 2 minutes whichever is greater measured with rated working voltage applied.									
Dissipation Factor (tan δ, at 20°C, 120Hz)	Working Voltage (VDC)	6.3 10 16 25 35 50 63 100								
	D.F. (%)max	16 14 12 10 9 8 8 8								
For capacitance > 1000 μF, add 2% per another 1000 μF.										
Low Temperature Characteristics (at 120Hz)	Impedance ratio max									
	Working Voltage	6.3 10 16 25 35 50 63 100								
	Z(-25°C) / Z(20°C)	4 3 3 3 3 3 2 2								
	Z(-40°C) / Z(20°C)	8 6 4 3 3 3 3 3								
For Capacitance > 1000 μF, add 0.5 per another 1000 μF for -25°C/+20°C add 1 per another 1000 μF for -40°C/+20°C										
Endurance	Test conditions									
	Duration time Ambient temperature Applied voltage	:as right :+105°C :Rated DC working voltage								
		<table border="1"> <thead> <tr> <th>D φ</th> <th>Life hours</th> </tr> </thead> <tbody> <tr> <td>5-6.3 φ</td> <td>2000</td> </tr> <tr> <td>8 φ</td> <td>3000</td> </tr> <tr> <td>≥ 10 φ</td> <td>5000</td> </tr> </tbody> </table>	D φ	Life hours	5-6.3 φ	2000	8 φ	3000	≥ 10 φ	5000
D φ	Life hours									
5-6.3 φ	2000									
8 φ	3000									
≥ 10 φ	5000									
After test requirement at +20°C										
Capacitance change		: ≤ ±20% of the initial measured value								
Dissipation factor		: ≤ 200% of the initial specified value								
Leakage current		: ≤ The initial specified value								
Shelf Life	Test conditions									
	Duration time Ambient temperature Applied voltage	:1000Hrs :+105°C :None								
After test requirement at +20°C: Same limits as Endurance. Pre-treatment for measurements shall be conducted after application of DC working voltage for 30 minutes.										

Radial

Multiplier for Ripple Current vs. Frequency

CAP(μF)/Frequency(Hz)	50(60)	120	400	1K	10K	50K~100K
CAP ≤ 10	0.47	0.59	0.76	0.85	0.97	1.0
10 < CAP ≤ 100	0.52	0.65	0.80	0.89	0.97	1.0
100 < CAP ≤ 1000	0.58	0.72	0.84	0.90	0.98	1.0
1000 < CAP	0.63	0.78	0.87	0.91	0.98	1.0

Diagram of Dimensions:(unit:mm)

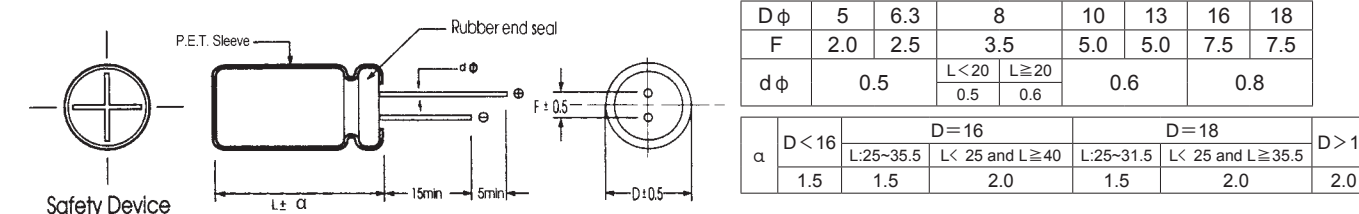

Case Size

WV (Vdc)	Cap (uF)	Size (mm)	Ripple current (mArms/105°C /100KHz)	Max ESR(Ω) at 20°C/100KHz
6.3	100	5x11	200	0.400
6.3	120	5x11	210	0.380
6.3	150	5x11	225	0.350
6.3	180	6.3x11	300	0.320
6.3	220	6.3x11	360	0.250
6.3	270	6.3x11	377	0.240
6.3	330	6.3x11	395	0.200
6.3	390	8x11.5	576	0.140
6.3	470	8x11.5	600	0.095
6.3	560	8x16	720	0.087
6.3	680	8x16	800	0.080
6.3	680	10x16	814	0.084
6.3	820	8x20	970	0.070
6.3	1000	10x12.5	1000	0.055
6.3	1200	8x20	1150	0.048
6.3	1200	10x16	1180	0.050
6.3	1500	10x20	1400	0.045
6.3	1500	10x25	1560	0.043
6.3	1800	10x20	1500	0.041
6.3	2200	10x25	1720	0.037
6.3	2200	13x20	1890	0.039
6.3	2700	13x20	2080	0.034
6.3	3300	13x20	2290	0.026
6.3	3900	10x30	2450	0.024
6.3	3900	13x25	2670	0.022
6.3	4700	13x30	3200	0.021
6.3	5600	13x35	3270	0.020
6.3	6800	16x31.5	3490	0.018
10	68	5x11	190	0.700
10	82	5x11	210	0.500
10	100	5x11	242	0.310
10	120	5x11	261	0.280
10	150	6.3x11	300	0.260
10	180	6.3x11	350	0.220
10	220	6.3x11	390	0.180
10	270	6.3x15	460	0.160
10	330	8x11.5	540	0.110
10	390	8x11.5	620	0.095
10	470	8x11.5	750	0.075
10	560	8x16	870	0.072
10	680	8x20	1010	0.068
10	820	8x20	1030	0.065
10	1000	8x20	1220	0.050
10	1000	10x16	1400	0.042
10	1200	10x20	1560	0.035
10	1500	10x20	1670	0.032
10	1800	10x25	2000	0.028
10	2200	13x20	2370	0.025
10	2700	13x20	2400	0.023
10	3300	13x25	2720	0.021
10	3900	13x30	3000	0.020
10	4700	13x35	3450	0.019
10	5600	16x31.5	3460	0.018
10	6800	16x31.5	3630	0.016
16	47	5x11	200	0.400
16	56	5x11	220	0.380
16	68	5x11	230	0.350
16	82	5x11	260	0.310
16	100	6.3x11	360	0.250

WV (Vdc)	Cap (uF)	Size (mm)	Ripple current (mArms/105°C /100KHz)	Max ESR(Ω) at 20°C/100KHz
16	120	6.3x11	365	0.230
16	150	6.3x11	385	0.210
16	180	8x11.5	520	0.190
16	220	8x11.5	575	0.140
16	270	8x11.5	600	0.120
16	330	8x11.5	740	0.080
16	390	8x16	790	0.075
16	470	8x16	990	0.062
16	470	10x12.5	1000	0.058
16	560	8x20	1070	0.057
16	680	8x20	1120	0.055
16	680	10x16	1280	0.052
16	820	10x20	1400	0.048
16	1000	10x20	1840	0.035
16	1200	10x25	1920	0.032
16	1500	10x25	2050	0.030
16	1500	13x20	2200	0.029
16	1800	13x20	2380	0.026
16	2200	13x25	2750	0.022
16	2700	13x25	3000	0.022
16	3300	13x35	3490	0.018
16	3900	16x25	3520	0.018
16	4700	16x31.5	3770	0.017
25	39	5x11	210	0.420
25	47	5x11	240	0.350
25	56	5x11	256	0.310
25	68	6.3x11	300	0.280
25	82	6.3x11	350	0.240
25	100	6.3x11	410	0.150
25	120	6.3x15	490	0.130
25	150	8x11.5	540	0.110
25	180	8x11.5	620	0.098
25	220	8x11.5	750	0.075
25	270	8x16	850	0.063
25	330	8x16	990	0.056
25	330	10x12.5	1010	0.054
25	390	10x12.5	1050	0.051
25	470	8x20	1260	0.045
25	470	10x16	1415	0.042
25	560	10x20	1450	0.040
25	680	10x20	1570	0.035
25	820	10x25	1910	0.032
25	1000	13x20	2340	0.025
25	1200	13x20	2390	0.025
25	1500	13x25	2710	0.023
25	1800	13x30	3150	0.021
25	2200	13x35	3420	0.018
25	2700	16x31.5	3480	0.018
25	3300	16x31.5	3600	0.018
35	33	5x11	230	0.320
35	39	6.3x11	277	0.310
35	47	6.3x11	340	0.200
35	56	6.3x11	375	0.200
35	68	6.3x11	400	0.190
35	82	8x11.5	480	0.170
35	100	8x11.5	560	0.150
35	120	8x11.5	585	0.130
35	150	8x11.5	680	0.110
35	180	8x16	810	0.098

WV (Vdc)	Cap (uF)	Size (mm)	Ripple current (mAmps/105°C /100KHz)	Max ESR(Ω) at 20°C/100KHz
35	220	8x16	1000	0.056
35	220	10x12.5	1060	0.052
35	270	10x16	1190	0.050
35	330	8x20	1210	0.041
35	330	10x16	1400	0.038
35	390	10x20	1550	0.035
35	470	10x20	1850	0.034
35	560	10x25	2040	0.031
35	680	13x20	2260	0.029
35	820	13x25	2630	0.021
35	1000	13x25	2780	0.019
35	1200	13x30	2950	0.019
35	1200	16x25	3150	0.018
35	1500	13x35	3350	0.018
35	1500	16x31.5	3600	0.017
35	1800	16x31.5	3670	0.016
35	2200	16x31.5	3750	0.015
35	2700	18x31.5	3850	0.014
50	22	5x11	220	0.350
50	27	6.3x11	265	0.340
50	33	6.3x11	280	0.320
50	39	6.3x11	300	0.280
50	47	8x11.5	360	0.200
50	56	8x11.5	385	0.190
50	68	8x11.5	400	0.170
50	82	8x11.5	550	0.120
50	100	8x11.5	730	0.075
50	120	8x16	770	0.073
50	120	10x12.5	790	0.072
50	150	10x12.5	870	0.068
50	180	8x20	1060	0.055
50	180	10x16	1090	0.055
50	220	10x16	1385	0.045
50	270	10x20	1500	0.043
50	330	10x25	1850	0.032
50	390	13x20	1910	0.031
50	470	13x20	2000	0.030
50	560	13x20	2150	0.028
50	680	13x25	2490	0.026
50	820	13x30	2770	0.025
50	820	16x25	2960	0.024
50	1000	16x25	3000	0.020
63	10	5x11	135	0.950
63	15	6.3x11	168	0.850
63	18	6.3x11	170	0.820
63	22	6.3x11	250	0.750
63	27	6.3x11	260	0.550
63	33	6.3x11	270	0.380
63	39	8x11.5	320	0.350
63	47	8x11.5	400	0.220
63	56	8x11.5	420	0.220

WV (Vdc)	Cap (uF)	Size (mm)	Ripple current (mAmps/105°C /100KHz)	Max ESR(Ω) at 20°C/100KHz
63	68	10x12.5	500	0.200
63	82	8x16	540	0.170
63	82	10x12.5	570	0.160
63	100	10x12.5	720	0.140
63	120	8x20	790	0.140
63	120	10x16	835	0.130
63	150	10x16	900	0.110
63	180	10x20	1200	0.095
63	220	10x25	1315	0.075
63	270	13x20	1400	0.071
63	330	10x30	1750	0.047
63	330	13x25	1870	0.045
63	390	13x25	1920	0.044
63	470	13x30	2225	0.041
63	470	16x20	1970	0.043
63	560	16x25	2350	0.039
63	680	16x31.5	2600	0.035
63	820	16x31.5	2650	0.031
63	1000	16x35.5	2780	0.026
63	1000	18x31.5	3230	0.028
100	4.7	5x11	105	1.600
100	5.6	5x11	116	1.490
100	6.8	5x11	120	1.450
100	10	6.3x11	170	0.700
100	15	8x11.5	255	0.610
100	18	8x11.5	270	0.560
100	22	8x11.5	320	0.480
100	27	8x11.5	340	0.390
100	33	8x16	400	0.310
100	39	8x16	425	0.290
100	39	10x12.5	440	0.270
100	47	10x12.5	450	0.250
100	56	10x16	540	0.210
100	68	10x20	630	0.180
100	82	10x20	720	0.150
100	100	10x25	890	0.120
100	120	10x25	900	0.120
100	120	13x20	980	0.110
100	150	13x20	1100	0.095
100	180	13x25	1250	0.078
100	220	13x30	1420	0.065
100	220	16x20	1270	0.075
100	270	13x35	1630	0.057
100	270	16x25	1570	0.058
100	330	13x40	1650	0.045
100	390	16x31.5	1850	0.043
100	470	16x35.5	1900	0.032
100	470	18x31.5	1700	0.038
100	560	16x40	2170	0.032
100	560	18x31.5	2100	0.031
100	680	18x35.5	2400	0.029

LZ Series Ultra Low Impedance

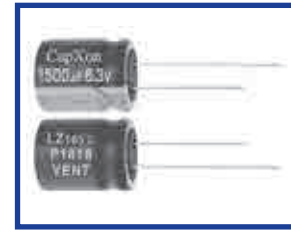

Features

- ◆ Ultra low impedance in 100KHz.
- ◆ Allow higher ripple current applied due to ultra low impedance.
- ◆ Endurance 2000hrs at 105°C
- ◆ Suitable for application of mother board, computer peripheral etc.
- ◆ RoHS Compliant

Specifications

Item	Performance Characteristics				
Operating Temperature Range	-40 ~ +105°C				
Rated Voltage Range	6.3 ~ 25V with rated working voltage applied				
Capacitance Range	220 to 3300 μF				
Capacitance Tolerance	±20% (20°C, 120Hz)				
Leakage Current (+20°C, max.)	I ≤ 0.01CV or 3 μA After 2 minutes whichever is greater measured				
Dissipation Factor (tan δ , at 20°C , 120Hz)	Rated Voltage(V)	6.3	10	16	25
	D.F. (%) max	14	12	10	9
For capacitance > 1000 μF, add 2% per another 1000 μF					
Low Temperature Characteristics (at 120Hz)	Impedance ratio max				
	Rated Voltage(V)	6.3	10	16	25
	Z-25°C / Z+20°C	4	3	2	2
	Z-40°C / Z+20°C	6	4	3	3
For Capacitance Value > 1000 μF, add 0.5 per another 1000 μF for -25°C / +20°C add 1 per another 1000 μF for -40°C / +20°C					
Endurance	Test Conditions				
	Duration	: 2000 hrs			
	Ambient temperature	: +105°C			
	Applied voltage	: Rated DC working voltage			
	After test requirement at +20°C	Capacitance change : Within ±25% of the initial measured value			
		Dissipation factor : Not exceed 200% of the initial specified value			
		Leakage current : Not exceed the specified value			
Shelf Life	Test Conditions				
	Duration	: 1000 hrs			
	Ambient temperature	: +105°C			
	After test requirement at +20°C	Capacitance change : Within ±25% of the initial measured value			
		Dissipation factor : Not exceed 200% of the initial specified value			
		Leakage current : Not exceed the specified value			

Multiplier for Ripple Current vs. Frequency

CAP(μF)/Frequency(Hz)	120	1K	10K	100K
100~330uF	0.40	0.75	0.93	1.00
390~1000uF	0.50	0.85	0.95	1.00
1200~3300uF	0.55	0.90	0.98	1.00

Diagram of Dimensions:(unit:mm)

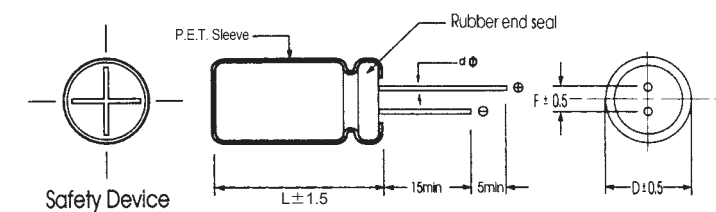

D φ	8		10
F	3.5		5.0
d φ	L < 20	L ≥ 20	0.6
	0.5	0.6	

Case Size

WV (Vdc)	Cap (uF)	Size (mm)	Ripple current (mArms/105°C /100KHz)	Max ESR(Ω) at 20°C/100KHz
6.3	560	8x11.5	1080	0.04
6.3	680	8x11.5	1080	0.04
6.3	820	8x11.5	1080	0.04
6.3	1000	8x16	1100	0.04
6.3	1000	10x12.5	1500	0.03
6.3	1200	8x16	1450	0.03
6.3	1500	8x20	1850	0.02
6.3	1500	10x12.5	1500	0.03
6.3	1800	10x16	1910	0.02
6.3	2200	8x20	1850	0.02
6.3	2200	10x16	1910	0.02
6.3	2700	10x20	2540	0.01
6.3	3300	10x30	2800	0.01
10	470	8x11.5	1080	0.04
10	560	8x11.5	1080	0.04
10	680	8x11.5	1080	0.04
10	680	10x12.5	1500	0.03
10	820	10x12.5	1450	0.03
10	1000	8x16	1450	0.03
10	1000	10x12.5	1500	0.03
10	1200	8x20	1850	0.02
10	1500	8x20	1850	0.02
10	1500	10x16	1910	0.02
10	1800	10x20	2540	0.02
10	2200	10x20	2540	0.02

WV (Vdc)	Cap (uF)	Size (mm)	Ripple current (mArms/105°C /100KHz)	Max ESR(Ω) at 20°C/100KHz
10	2200	10x25	2800	0.01
16	330	8x11.5	1080	0.04
16	470	8x11.5	1080	0.04
16	470	10x12.5	1500	0.03
16	560	8x16	1450	0.03
16	680	8x16	1450	0.03
16	680	10x12.5	1500	0.03
16	820	8x20	1850	0.02
16	1000	8x20	1850	0.02
16	1000	10x16	1910	0.02
16	1200	10x20	2540	0.02
16	1500	10x20	2540	0.02
16	1800	10x25	2800	0.01
25	220	8x11.5	1080	0.032
25	270	8x11.5	1150	0.031
25	330	8x11.5	1450	0.029
25	330	10x12.5	1650	0.027
25	470	8x20	1720	0.020
25	470	10x12.5	1700	0.025
25	470	10x16	1830	0.022
25	560	10x16	1850	0.021
25	680	8x20	1820	0.018
25	680	10x16	1920	0.02
25	680	10x20	2060	0.02
25	1000	10x20	2180	0.02

GH Series

Features

- ◆ Low impedance
- ◆ High temperature, Long life 3,000 to 10,000 hours at 105°C
- ◆ AEC-Q200 qualified

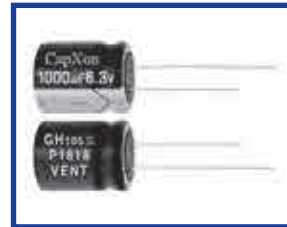

Specifications

Item	Performance Characteristics																												
Operating Temperature Range	-55 to +105°C																												
Rated Voltage Range	6.3 to 100 VDC																												
Capacitance Range	0.47 to 12000 µF																												
Capacitance Tolerance	±20%(120Hz, +20°C)																												
Leakage Current (+20°C, max.)	$I \leq 0.01 CV$ or $3 (\mu A)$ (After 2 minute with rated working voltage applied.)																												
Dissipation Factor (tan δ , at 20°C , 120Hz)	<table border="1"> <tr> <td>Working Voltage(VDC)</td> <td>6.3</td> <td>10</td> <td>16</td> <td>25</td> <td>35</td> <td>50</td> </tr> <tr> <td>D.F.(%)max.</td> <td>22</td> <td>19</td> <td>16</td> <td>14</td> <td>12</td> <td>10</td> </tr> </table>	Working Voltage(VDC)	6.3	10	16	25	35	50	D.F.(%)max.	22	19	16	14	12	10														
	Working Voltage(VDC)	6.3	10	16	25	35	50																						
D.F.(%)max.	22	19	16	14	12	10																							
For capacitance > 1000 µ F, add 2% per another 1000 µ F.																													
Low Temperature Characteristics (at 120Hz)	Impedance ratio max																												
	<table border="1"> <tr> <td>Rated voltage(VDC)</td> <td>6.3</td> <td>10</td> <td>16</td> <td>25</td> <td>35</td> <td>50</td> </tr> <tr> <td>Z-25°C / Z+20°C</td> <td>4</td> <td>3</td> <td>2</td> <td>2</td> <td>1.5</td> <td>1.5</td> </tr> <tr> <td>Z-40°C / Z+20°C</td> <td>6</td> <td>4</td> <td>3</td> <td>3</td> <td>2</td> <td>2</td> </tr> <tr> <td>Z-55°C / Z+20°C</td> <td>8</td> <td>6</td> <td>5</td> <td>5</td> <td>4</td> <td>4</td> </tr> </table>	Rated voltage(VDC)	6.3	10	16	25	35	50	Z-25°C / Z+20°C	4	3	2	2	1.5	1.5	Z-40°C / Z+20°C	6	4	3	3	2	2	Z-55°C / Z+20°C	8	6	5	5	4	4
	Rated voltage(VDC)	6.3	10	16	25	35	50																						
	Z-25°C / Z+20°C	4	3	2	2	1.5	1.5																						
Z-40°C / Z+20°C	6	4	3	3	2	2																							
Z-55°C / Z+20°C	8	6	5	5	4	4																							
For Capacitance > 1000 µ F, add 0.5 per another 1000 µ F for -25°C/+20°C add 1 per another 1000 µ F for -40°C/+20°C add 1.5 per another 1000 µ F for -55°C/+20°C																													
Endurance	Test condition																												
	Duration time:																												
	<table border="1"> <tr> <td>D φ</td> <td>5-6.3 φ</td> <td>8-12 φ</td> <td>≥ 13 φ</td> </tr> <tr> <td>+105°C Life hours</td> <td>5000 hours</td> <td>7000 hours</td> <td>10000 hours</td> </tr> </table>	D φ	5-6.3 φ	8-12 φ	≥ 13 φ	+105°C Life hours	5000 hours	7000 hours	10000 hours																				
D φ	5-6.3 φ	8-12 φ	≥ 13 φ																										
+105°C Life hours	5000 hours	7000 hours	10000 hours																										
Ambient temperature :+105°C Applied voltage :Rated DC working voltage After test requirement at +20°C Capacitance change : ≤ ±25% of the initial measured value Dissipation factor : ≤200% of the initial specified value Leakage current : ≤ The initial specified value																													
Shelf Life	Test condition																												
	Duration time :1000 Hrs Ambient temperature :+105°C Applied voltage :None After test requirement at +20°C: Same limits as Endurance. Pre-treatment for measurements shall be conducted after application of DC working voltage for 30 minutes.																												

Multiplier for Ripple Current vs. Frequency

CAP(µ F)\Frequency(Hz)	120	400	1K	10K	100K
CAP ≤ 10	0.40	0.52	0.60	0.92	1
10 < CAP ≤ 100	0.67	0.80	0.83	0.94	1
100 < CAP ≤ 1000	0.75	0.84	0.88	0.95	1
1000 < CAP	0.82	0.87	0.92	0.95	1

Diagram of Dimensions:(unit:mm)

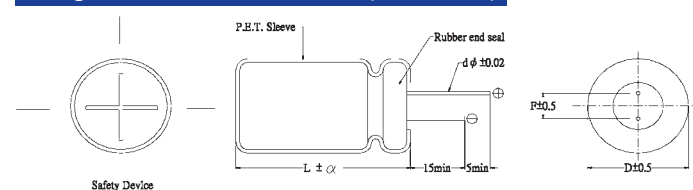

D φ	5	6.3	8	10	13	16	18
F	2.0	2.5	3.5	5.0	5.0	7.5	7.5
d φ	0.5	L < 20 0.5	L ≥ 20 0.6	0.6	0.6	0.8	0.8
α	D < 16	D = 16		D = 18		D > 18	
	1.5	L: 25~35.5	L < 25 and L ≥ 40	L: 25~31.5	L < 25 and L ≥ 35.5	1.5	2.0

Case Size

WV (Vdc)	Cap (uF)	Size (mm)	Ripple current (mA rms/105°C /100KHz)	Max ESR(Ω) at 20°C/100KHz
6.3	82	5x11	198	1.63
6.3	100	5x11	210	1.45
6.3	120	5x11	222	1.28
6.3	150	6.3x11	240	1.16
6.3	180	6.3x11	282	1.04
6.3	220	6.3x11	378	0.89
6.3	270	6.3x11	396	0.77
6.3	330	6.3x11	396	0.77
6.3	330	6.3x15	426	0.68
6.3	330	8x11.5	444	0.68
6.3	390	6.3x15	462	0.58
6.3	390	8x11.5	480	0.52
6.3	470	6.3x15	504	0.41
6.3	470	8x11.5	534	0.38
6.3	470	10x12.5	564	0.38
6.3	560	8x11.5	570	0.36
6.3	560	8x16	600	0.36
6.3	560	10x12.5	612	0.36
6.3	680	8x11.5	582	0.33
6.3	680	8x16	618	0.33
6.3	680	10x12.5	642	0.33
6.3	820	8x11.5	666	0.25
6.3	820	10x12.5	720	0.25
6.3	1000	8x16	690	0.22
6.3	1000	8x20	756	0.22
6.3	1000	10x12.5	708	0.22
6.3	1200	8x20	840	0.18
6.3	1200	10x16	888	0.18
6.3	1500	8x20	1056	0.15
6.3	1500	10x16	1128	0.12
6.3	1500	10x20	1176	0.12
6.3	1800	8x25	1230	0.11
6.3	1800	10x20	1308	0.11
6.3	2200	10x20	1350	0.10
6.3	2200	10x25	1362	0.10
6.3	2700	10x25	1488	0.09
6.3	2700	10x30	1560	0.09
6.3	2700	13x20	1512	0.09
6.3	3300	10x30	1620	0.085
6.3	3300	13x20	1584	0.085
6.3	3900	13x25	1860	0.080
6.3	4700	13x25	1938	0.075
6.3	4700	13x30	1992	0.070
6.3	5600	13x30	1992	0.068
6.3	5600	16x25	2196	0.068
6.3	6800	13x30	2520	0.063
6.3	6800	16x25	2718	0.063
10	22	5x11	66	3.08
10	27	5x11	72	2.67
10	33	5x11	72	2.33
10	39	5x11	120	2.02
10	47	5x11	132	1.71
10	56	5x11	144	1.47
10	68	5x11	162	1.30
10	82	5x11	192	1.15
10	100	5x11	222	1.02
10	100	6.3x11	240	1.02
10	120	5x11	246	1.02
10	120	6.3x11	258	1.02

WV (Vdc)	Cap (uF)	Size (mm)	Ripple current (mA rms/105°C /100KHz)	Max ESR(Ω) at 20°C/100KHz
10	150	6.3x11	282	0.95
10	180	6.3x11	318	0.68
10	220	6.3x11	366	0.60
10	220	6.3x15	390	0.58
10	270	6.3x15	414	0.56
10	270	8x11.5	420	0.53
10	330	6.3x11	402	0.50
10	330	6.3x15	462	0.47
10	330	8x11.5	492	0.45
10	390	6.3x15	456	0.42
10	390	8x11.5	516	0.42
10	470	6.3x15	480	0.37
10	470	8x11.5	552	0.30
10	560	8x11.5	588	0.28
10	560	8x16	636	0.25
10	560	10x12.5	636	0.25
10	680	8x16	660	0.21
10	680	8x20	684	0.20
10	680	10x12.5	684	0.20
10	820	8x16	732	0.20
10	820	8x20	828	0.18
10	820	10x12.5	876	0.16
10	820	10x16	936	0.16
10	1000	8x16	1020	0.16
10	1000	8x20	1122	0.14
10	1000	10x12.5	1032	0.14
10	1000	10x16	1140	0.13
10	1200	8x20	1248	0.13
10	1200	10x16	1272	0.13
10	1200	10x20	1368	0.12
10	1500	10x20	1536	0.106
10	1500	13x16	1620	0.110
10	1800	10x25	1650	0.102
10	1800	13x20	1704	0.098
10	2200	10x25	1776	0.095
10	2200	10x30	1860	0.093
10	2200	13x20	1872	0.093
10	2200	16x16	1926	0.093
10	2700	10x30	2076	0.084
10	2700	13x20	2028	0.084
10	2700	13x25	2124	0.084
10	2700	18x16	2241	0.084
10	3300	10x30	2232	0.070
10	3300	13x25	2268	0.070
10	3300	16x25	2316	0.070
10	3900	13x25	2304	0.065
10	3900	13x30	2376	0.065
10	3900	16x20	2362	0.070
10	3900	16x25	2544	0.065
10	4700	13x30	2484	0.065
10	4700	13x35	2568	0.060
10	4700	16x25	2634	0.057
10	5600	13x35	2640	0.054
10	5600	16x25	2473	0.054
10	5600	16x31.5	2736	0.050
10	5600	18x20	2460	0.057
10	6800	16x31.5	2964	0.046
10	6800	18x25	2866	0.052
10	8200	16x35.5	3350	0.043

WV (Vdc)	Cap (uF)	Size (mm)	Ripple current (mA rms/105°C /100KHz)	Max ESR(Ω) at 20°C/100KHz
10	8200	18x31.5	3392	0.044
10	10000	16x40	3850	0.040
10	10000	18x35.5	3850	0.041
10	12000	18x40	4150	0.037
16	10	5x11	36	3.90
16	15	5x11	72	3.32
16	22	5x11	72	2.64
16	27	5x11	132	2.37
16	33	5x11	144	2.00
16	39	5x11	168	1.61
16	47	5x11	186	1.35
16	56	5x11	210	1.24
16	68	5x11	228	1.18
16	82	6.3x11	264	1.03
16	100	5x11	228	1.10
16	100	6.3x11	264	0.86
16	120	6.3x11	312	0.66
16	150	6.3x11	336	0.58
16	150	6.3x15	396	0.58
16	180	6.3x15	420	0.56
16	180	8x11.5	426	0.54
16	220	6.3x15	504	0.52
16	220	8x11.5	540	0.46
16	270	6.3x15	540	0.42
16	270	8x11.5	582	0.38
16	330	6.3x15	588	0.34
16	330	8x11.5	588	0.37
16	330	8x16	618	0.35
16	390	8x11.5	612	0.33
16	390	8x16	654	0.33
16	390	10x12.5	648	0.33
16	470	8x16	846	0.29
16	470	8x20	900	0.28
16	470	10x12.5	882	0.28
16	560	8x16	864	0.26
16	560	8x20	936	0.24
16	560	10x12.5	882	0.24
16	560	10x16	960	0.20
16	680	8x20	960	0.20
16	680	10x16	1044	0.18
16	820	8x20	1104	0.17
16	820	10x16	1254	0.15
16	820	10x20	1320	0.15
16	1000	10x16	1404	0.14
16	1000	10x20	1476	0.12
16	1200	10x20	1500	0.13
16	1200	10x25	1578	0.11
16	1500	10x25	1620	0.096
16	1500	13x20	1728	0.095
16	1500	16x16	1778	0.095
16	1800	10x30	1776	0.097
16	1800	13x20	1854	0.094
16	1800	13x25	1956	0.090
16	2200	13x20	2082	0.090
16	2200	13x25	2340	0.085
16	2200	18x16	2300	0.090
16	2700	13x25	2436	0.076
16	2700	13x30	2496	0.072
16	2700	16x20	2362	0.074
16	2700	16x25	2544	0.072
16	3300	13x30	2562	0.068

WV (Vdc)	Cap (uF)	Size (mm)	Ripple current (mA rms/105°C /100KHz)	Max ESR(Ω) at 20°C/100KHz
16	3300	13x35	2628	0.066
16	3300	16x25	2700	0.064
16	3900	13x35	2664	0.050
16	3900	16x25	2736	0.060
16	3900	16x31.5	2856	0.058
16	3900	18x20	2721	0.060
16	4700	16x31.5	2886	0.050
16	4700	18x25	2844	0.055
16	5600	16x35.5	2968	0.046
16	5600	18x31.5	3084	0.048
16	5600	18x35.5	3168	0.045
16	6800	16x40	3252	0.040
16	6800	18x35.5	3252	0.040
16	8200	18x35.5	3750	0.038
16	10000	18x40	4150	0.036
25	10	5x11	66	3.01
25	15	5x11	120	2.64
25	22	5x11	144	2.30
25	27	5x11	156	2.03
25	33	5x11	174	1.72
25	39	5x11	174	1.50
25	47	5x11	222	1.37
25	47	6.3x11	240	1.28
25	56	5x11	264	1.25
25	68	6.3x11	300	0.97
25	82	6.3x11	312	0.79
25	100	6.3x11	360	0.68
25	100	8x11.5	516	0.54
25	120	6.3x11	402	0.58
25	120	6.3x15	462	0.56
25	150	6.3x15	510	0.54
25	150	8x11.5	528	0.52
25	180	6.3x15	546	0.51
25	180	8x11.5	552	0.46
25	220	8x11.5	618	0.42
25	220	8x16	642	0.40
25	270	8x11.5	750	0.34
25	270	8x16	756	0.32
25	270	10x12.5	816	0.32
25	330	8x16	960	0.25
25	330	10x12.5	924	0.24
25	470	8x20	1056	0.23
25	470	10x12.5	1020	0.21
25	470	10x16	1080	0.21
25	560	8x20	1224	0.17
25	560	10x16	1260	0.15
25	680	10x20	1470	0.11
25	680	13x16	1550	0.10
25	820	10x20	1668	0.11
25	820	10x25	1704	0.10
25	1000	10x25	1812	0.093
25	1000	13x20	1872	0.090
25	1000	16x16	1926	0.088
25	1200	13x20	2028	0.082
25	1200	18x16	2241	0.080
25	1500	13x20	2124	0.067
25	1500	13x25	2190	0.065
25	1800	13x30	2310	0.058
25	1800	16x20	2173	0.056
25	1800	16x25	2340	0.058
25	2200	13x30	2592	0.052

WV (Vdc)	Cap (uF)	Size (mm)	Ripple current (mAmps/105°C /100KHz)	Max ESR(Ω) at 20°C/100KHz
25	2200	16x25	2712	0.050
25	2200	18x20	2697	0.052
25	2700	13x35	2850	0.050
25	2700	16x25	2674	0.048
25	2700	16x31.5	2958	0.046
25	3300	16x31.5	3204	0.038
25	3300	16x35.5	3288	0.036
25	3300	18x25	3156	0.041
25	3900	16x35.5	3500	0.036
25	3900	18x31.5	3544	0.036
25	4700	16x40	3800	0.034
25	4700	18x35.5	3800	0.034
25	5600	18x40	4100	0.030
35	10	5x11	84	2.65
35	15	5x11	144	2.29
35	22	5x11	162	1.90
35	27	5x11	174	1.58
35	27	6.3x11	198	1.42
35	33	5x11	222	1.25
35	33	6.3x11	240	1.25
35	39	6.3x11	252	1.10
35	47	5x11	232	0.10
35	47	6.3x11	264	0.92
35	56	6.3x11	282	0.75
35	56	6.3x15	306	0.68
35	68	6.3x11	312	0.62
35	68	6.3x15	348	0.55
35	82	6.3x15	354	0.51
35	82	8x11.5	384	0.47
35	100	6.3x11	329	0.49
35	100	6.3x15	378	0.47
35	100	8x11.5	414	0.45
35	120	8x11.5	546	0.42
35	120	8x16	612	0.38
35	150	8x11.5	618	0.38
35	150	8x16	714	0.35
35	150	10x12.5	720	0.35
35	180	8x16	792	0.32
35	180	10x12.5	804	0.32
35	220	8x16	864	0.26
35	220	8x20	936	0.24
35	220	10x12.5	888	0.24
35	270	8x20	1056	0.22
35	270	10x12.5	984	0.24
35	270	10x16	1068	0.21
35	330	8x20	1140	0.16
35	330	10x16	1176	0.15
35	470	10x20	1302	0.11
35	470	10x25	1398	0.10
35	470	13x16	1272	0.11
35	470	13x20	1398	0.10
35	560	10x25	1572	0.096
35	560	13x20	1584	0.096
35	680	10x25	1680	0.084
35	680	13x20	1692	0.082
35	680	16x16	1741	0.080
35	820	13x20	1818	0.068
35	820	13x25	1944	0.062
35	1000	10x30	2136	0.060
35	1000	13x25	2184	0.060
35	1000	13x30	2280	0.058

WV (Vdc)	Cap (uF)	Size (mm)	Ripple current (mAmps/105°C /100KHz)	Max ESR(Ω) at 20°C/100KHz
35	1000	18x16	2189	0.056
35	1200	13x25	2292	0.052
35	1200	16x20	2384	0.052
35	1200	16x25	2568	0.050
35	1500	13x35	2820	0.048
35	1500	16x31.5	2928	0.048
35	1800	13x35	2976	0.045
35	1800	16x25	2722	0.048
35	1800	16x31.5	3012	0.045
35	1800	18x20	2708	0.048
35	2200	16x31.5	3228	0.036
35	2200	18x25	3132	0.036
35	2700	16x35.5	3295	0.032
35	2700	18x31.5	3336	0.032
35	3300	16x40	3800	0.029
35	3300	18x35.5	3800	0.029
35	3900	18x40	4100	0.026
50	0.47	5x11	12	7.23
50	1	5x11	24	4.31
50	2.2	5x11	36	3.60
50	3.3	5x11	48	3.50
50	4.7	5x11	66	3.30
50	5.6	5x11	96	3.20
50	6.8	5x11	96	3.00
50	8.2	5x11	108	2.80
50	10	5x11	120	2.60
50	15	5x11	150	1.87
50	22	5x11	162	1.60
50	22	6.3x11	168	1.27
50	27	6.3x11	192	1.02
50	33	6.3x11	282	0.87
50	33	6.3x15	296	0.85
50	39	6.3x11	306	0.72
50	39	6.3x15	330	0.70
50	47	6.3x11	303	0.06
50	47	6.3x15	348	0.55
50	47	8x11.5	366	0.55
50	56	6.3x11	324	0.05
50	56	8x11.5	378	0.47
50	68	8x11.5	420	0.36
50	82	6.3x15	462	0.35
50	82	8x11.5	492	0.32
50	82	8x16	528	0.28
50	100	8x11.5	540	0.28
50	100	8x16	576	0.25
50	120	8x16	630	0.25
50	150	8x16	696	0.24
50	150	8x20	756	0.24
50	150	10x12.5	702	0.25
50	150	10x16	780	0.24
50	180	8x20	864	0.24
50	180	10x16	912	0.24
50	220	10x16	1056	0.24
50	220	10x20	1122	0.20
50	270	10x20	1212	0.10
50	270	10x25	1284	0.10
50	270	13x16	1278	0.10
50	330	10x25	1404	0.095
50	330	13x20	1500	0.082
50	470	10x30	1750	0.078
50	470	13x20	1776	0.078

WV (Vdc)	Cap (uF)	Size (mm)	Ripple current (mA _{rms} /105°C /100KHz)	Max ESR(Ω) at 20°C/100KHz
50	470	13x25	1860	0.078
50	470	16x16	1827	0.078
50	560	13x20	2094	0.075
50	560	13x25	2172	0.070
50	560	18x16	2314	0.073
50	680	13x25	2304	0.057
50	680	16x25	2376	0.057
50	820	13x30	2412	0.052
50	820	16x20	2085	0.054
50	820	16x31.5	2484	0.052
50	1000	13x40	2750	0.048
50	1000	16x25	2676	0.050
50	1000	16x31.5	2736	0.048
50	1000	18x20	2662	0.050
50	1200	16x31.5	2952	0.045
50	1200	16x35.5	3048	0.042
50	1200	18x25	2854	0.047
50	1500	16x35.5	3216	0.038
50	1800	16x40	3550	0.035
50	1800	18x31.5	3368	0.035
50	2200	18x35.5	3550	0.032
50	2700	18x40	3790	0.030
50	3300	18x40	3810	0.028
63	10	5x11	116	3.02
63	15	5x11	131	2.37
63	22	5x11	151	1.77
63	22	6.3x11	194	1.39
63	27	6.3x11	202	1.29
63	33	6.3x11	228	1.01
63	39	6.3x11	243	0.89
63	47	6.3x11	264	0.75
63	47	8x11.5	313	0.73
63	56	8x11.5	320	0.70
63	68	8x11.5	378	0.50
63	68	8x16	477	0.42
63	82	8x11.5	390	0.47
63	82	8x16	477	0.42
63	82	10x12.5	481	0.43
63	100	8x16	515	0.36
63	100	10x12.5	515	0.38
63	120	8x16	512	0.36
63	120	8x20	604	0.32
63	120	10x12.5	528	0.36
63	120	10x16	639	0.30
63	150	8x20	604	0.32
63	150	10x16	666	0.28
63	180	8x25	742	0.26
63	180	10x16	662	0.28
63	180	10x20	757	0.26
63	220	8x25	789	0.23
63	220	10x16	730	0.23
63	220	10x20	892	0.20
63	220	13x16	911	0.20
63	270	10x20	986	0.16
63	270	13x20	1241	0.13
63	330	10x25	1242	0.13
63	330	13x16	1086	0.15
63	330	13x20	1282	0.13
63	330	13x25	1611	0.100
63	390	13x25	1618	0.093
63	470	13x20	1516	0.093

WV (Vdc)	Cap (uF)	Size (mm)	Ripple current (mA _{rms} /105°C /100KHz)	Max ESR(Ω) at 20°C/100KHz
63	470	13x25	1698	0.090
63	470	13x30	1863	0.088
63	470	16x20	1857	0.082
63	560	13x25	1727	0.087
63	560	13x30	1942	0.081
63	560	16x20	1857	0.082
63	680	13x30	2082	0.071
63	680	13x35	2273	0.068
63	680	16x20	1835	0.084
63	820	13x40	2454	0.066
63	820	16x25	2229	0.066
63	820	18x20	2108	0.073
63	1000	13x45	2653	0.063
63	1000	16x31.5	2690	0.056
63	1000	18x25	2307	0.071
63	1200	16x31.5	2727	0.054
63	1200	18x25	2470	0.062
63	1500	18x31.5	2997	0.051
63	1500	18x35.5	3256	0.048
63	1800	16x40	3760	0.036
63	1800	18x35.5	3481	0.042
63	2200	18x40	3938	0.035
80	10	5x11	100	4.07
80	15	5x11	113	3.20
80	22	6.3x11	167	1.88
80	27	6.3x11	174	1.74
80	33	6.3x11	196	1.37
80	39	8x11.5	244	1.20
80	47	8x11.5	265	1.02
80	56	8x11.5	275	0.95
80	56	8x16	326	0.90
80	68	8x16	380	0.66
80	68	10x12.5	388	0.66
80	82	8x16	389	0.63
80	82	10x12.5	388	0.66
80	100	8x20	509	0.45
80	100	10x16	522	0.45
80	100	13x16	634	0.44
80	120	10x16	534	0.43
80	150	10x20	657	0.35
80	150	13x16	665	0.40
80	180	10x20	677	0.33
80	180	10x25	755	0.32
80	180	13x16	721	0.34
80	220	10x25	767	0.31
80	220	13x20	830	0.31
80	270	13x20	890	0.27
80	270	13x25	1019	0.25
80	330	13x20	1060	0.19
80	330	16x20	1253	0.18
80	390	13x30	1427	0.15
80	470	13x30	1533	0.13
80	470	13x35	1711	0.12
80	470	16x25	1432	0.16
80	470	18x20	1471	0.15
80	560	13x40	1685	0.14
80	560	16x25	1479	0.15
80	560	18x20	1471	0.15
80	680	16x31.5	1757	0.13
80	680	18x25	1582	0.15
80	820	16x35.5	1929	0.12

WV (Vdc)	Cap (uF)	Size (mm)	Ripple current (mA _{rms} /105°C /100KHz)	Max ESR(Ω) at 20°C/100KHz
80	820	18x25	1699	0.13
80	1000	16x35.5	1929	0.12
80	1000	16x40	2151	0.11
80	1000	18x31.5	2041	0.11
80	1200	16x40	2378	0.09
80	1200	18x35.5	2315	0.095
80	1500	16x40	2461	0.084
80	1500	18x40	2641	0.083
80	1800	18x40	2657	0.082
100	4.7	5x11	84	5.75
100	5.6	5x11	90	5.00
100	6.8	5x11	96	4.36
100	8.2	5x11	105	3.68
100	10	6.3x11	141	2.63
100	10	8x11.5	180	2.20
100	15	6.3x11	151	2.31
100	22	6.3x11	168	1.85
100	22	8x11.5	228	1.38
100	27	8x11.5	234	1.31
100	33	8x11.5	240	1.24
100	39	8x16	282	1.20
100	47	8x16	335	0.85
100	47	10x12.5	350	0.81
100	47	10x16	357	0.78
100	56	8x16	354	0.76
100	56	8x20	414	0.68
100	56	10x12.5	364	0.75
100	68	8x20	424	0.65
100	68	10x16	425	0.68
100	82	8x20	474	0.52
100	82	10x16	486	0.52
100	100	8x30	636	0.42
100	100	10x16	522	0.45
100	100	10x20	596	0.42

WV (Vdc)	Cap (uF)	Size (mm)	Ripple current (mA _{rms} /105°C /100KHz)	Max ESR(Ω) at 20°C/100KHz
100	100	13x16	641	0.43
100	100	13x20	750	0.38
100	120	8x35	738	0.36
100	120	10x20	611	0.40
100	120	10x25	702	0.37
100	120	13x16	665	0.40
100	150	10x25	743	0.33
100	150	10x30	834	0.31
100	150	13x20	805	0.33
100	180	13x20	858	0.29
100	180	13x25	963	0.28
100	220	13x20	890	0.27
100	220	13x25	1019	0.25
100	220	16x16	915	0.27
100	220	16x20	1063	0.25
100	270	10x40	1107	0.23
100	270	13x30	1236	0.20
100	270	16x25	1281	0.20
100	330	13x30	1382	0.16
100	330	13x35	1584	0.14
100	330	16x25	1531	0.14
100	390	13x40	1748	0.13
100	390	18x25	1582	0.15
100	470	16x25	1479	0.15
100	470	16x31.5	1910	0.11
100	470	18x25	1637	0.14
100	560	16x35.5	1854	0.13
100	560	18x31.5	1877	0.13
100	680	16x35.5	1929	0.12
100	680	18x35.5	2151	0.11
100	820	18x35.5	2202	0.105
100	820	18x40	2406	0.100
100	1000	18x40	2469	0.095

GT Series 105°C Miniaturized, Long Life

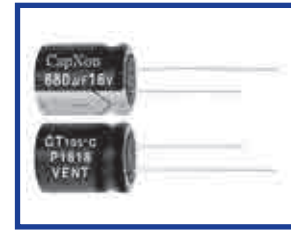

Features

- ◆ Long Life: 105°C 10000 hours.
- ◆ RoHS compliance.

Specifications

Item	Performance Characteristics
Operating Temperature Range	-40 to +105°C
Rated Voltage Range	10~100V.DC
Capacitance Tolerance	±20%(120Hz, +20°C)
Leakage Current (+20°C, max.)	$I \leq 0.01CV$ or $3\mu A$ whichever is greater. (After 2 minutes) I= Leakage Current(μA) C= Rated Capacitance V= Rated voltage(V)
Dissipation Factor ($\tan \delta$ at 20°C · 120Hz)	Working Voltage(VDC) 10 16 25 35 50 63 100
	D.F.(%)max. 45 35 30 22 19 17 15
Low Temperature Characteristics (at 120Hz)	Impedance ratio max
	Rated voltage(VDC) 10 16 25 35 50 63
	Z-25°C / Z+20°C 10 8 6 6 5 5
For capacitance > 1000 μF, add 1 per another 1000 μF for -40°C/+20°C.	
Endurance	Duration time :10000Hrs
	Ambient temperature :+105°C
	Applied voltage :Rated DC working voltage
	After test requirement at +20°C
	Capacitance change :≤ ±25% of the initial measured value
	Dissipation factor :≤300% of the initial specified value
Leakage current :≤The initial specified value	
Shelf Life	Test condition
	Duration time :1000 Hrs
	Ambient temperature :+105°C
	Applied voltage :None
	After test requirement at +20°C: Same limits as Endurance. Pre-treatment for measurements shall be conducted after application of DC working voltage for 30 minutes.

Multiplier for Ripple Current vs. Frequency

CAP(μF)\Frequency(Hz)	120	1K	10K	100K≤
1~10 μ F	0.42	0.60	0.80	1.00
22~33 μ F	0.55	0.75	0.90	1.00
47~330 μ F	0.70	0.85	0.95	1.00

Diagram of Dimensions:(unit:mm)

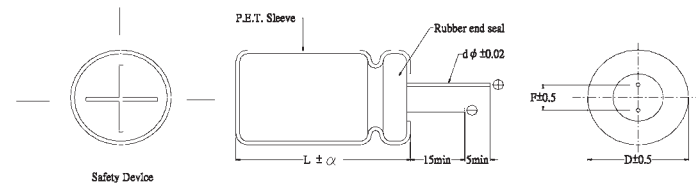

DΦ	5	6.3	8
F	2.0	2.5	3.5
dΦ	0.5	L<20	L≥20
		0.5	0.6
α	α=1.5		

Case Size

WV (Vdc)	Cap (uF)	Size (mm)	Rated Ripple current (mAmps/105°C /100KHz)
10	100	5x11	140
10	220	6.3x11	220
10	330	8x11.5	340
16	47	5x11	140
16	100	6.3x11	220
16	220	8x11.5	340
25	33	5x11	140
25	47	5x11	140
25	100	6.3x11	220
35	33	5x11	90
35	47	6.3x11	220
35	100	8x11.5	340
50	1	5x11	26
50	2.2	5x11	36
50	3.3	5x11	75
50	4.7	5x11	85

WV (Vdc)	Cap (uF)	Size (mm)	Rated Ripple current (mAmps/105°C /100KHz)
50	10	5x11	95
50	22	5x11	140
50	33	6.3x11	200
50	47	6.3x11	200
50	100	8x11.5	280
63	10	5x11	85
63	22	6.3x11	180
63	33	6.3x11	180
63	47	8x11.5	250
100	1	5x11	40
100	2.2	5x11	50
100	3.3	5x11	60
100	4.7	5x11	70
100	10	6.3x11	150
100	22	8x11.5	230

FH 105°C high ripple current at frequency range

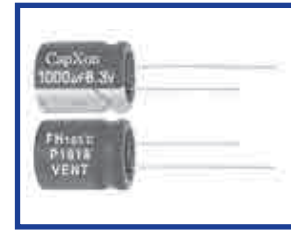

Features

- ◆ New innovative electrolyte is employed to minimize ESR
- ◆ Long life 4,000 to 10,000 hours at 105°C
- ◆ Non solvent proof type
- ◆ 6.3 to 100VDC newly type
- ◆ RoHS compliant

Specifications

Item	Performance Characteristics																											
Operating Temperature Range	-40 to +105°C																											
Rated Voltage Range	6.3 to 100VDC																											
Capacitance Tolerance	±20%(120Hz,+20°C)																											
Capacitance Range	22~5600 µF																											
Leakage Current (+20°C,max.)	I=0.01 CV or 3 (µA) (After 2 minute) with rated working voltage applied.)																											
Dissipation Factor (tan δ , at 20°C , 120Hz)	<table border="1"> <tr> <td>Working Voltage(VDC)</td> <td>6.3</td> <td>10</td> <td>16</td> <td>25</td> <td>35</td> <td>50</td> <td>63</td> <td>100</td> </tr> <tr> <td>D. F.(%) max.</td> <td>22</td> <td>19</td> <td>16</td> <td>14</td> <td>12</td> <td>10</td> <td>9</td> <td>8</td> </tr> </table>	Working Voltage(VDC)	6.3	10	16	25	35	50	63	100	D. F.(%) max.	22	19	16	14	12	10	9	8									
	Working Voltage(VDC)	6.3	10	16	25	35	50	63	100																			
D. F.(%) max.	22	19	16	14	12	10	9	8																				
For capacitance > 1000µF,add 2% per another 1000µF.																												
Low Temperature Characteristics (at 120Hz)	Impedance ratio max																											
	<table border="1"> <tr> <td>Working Voltage(VDC)</td> <td>6.3</td> <td>10</td> <td>16</td> <td>25</td> <td>35</td> <td>50</td> <td>63</td> <td>100</td> </tr> <tr> <td>Z-25°C / Z+20°C</td> <td>4</td> <td>3</td> <td>2</td> <td>2</td> <td>2</td> <td>2</td> <td>2</td> <td>2</td> </tr> <tr> <td>Z-40°C / Z+20°C</td> <td>8</td> <td>6</td> <td>4</td> <td>3</td> <td>3</td> <td>3</td> <td>3</td> <td>3</td> </tr> </table>	Working Voltage(VDC)	6.3	10	16	25	35	50	63	100	Z-25°C / Z+20°C	4	3	2	2	2	2	2	2	Z-40°C / Z+20°C	8	6	4	3	3	3	3	3
	Working Voltage(VDC)	6.3	10	16	25	35	50	63	100																			
Z-25°C / Z+20°C	4	3	2	2	2	2	2	2																				
Z-40°C / Z+20°C	8	6	4	3	3	3	3	3																				
Endurance	Test conditions Duration time :																											
	<table border="1"> <tr> <td></td> <td>SIZE</td> <td>φ D≤6.3</td> <td>φ D = 8,10</td> <td>φ D ≥ 13</td> </tr> <tr> <td rowspan="2">Voltage</td> <td>6.3~10WV</td> <td>4000 hours</td> <td>6000 hours</td> <td>8000 hours</td> </tr> <tr> <td>16~100WV</td> <td>5000 hours</td> <td>7000 hours</td> <td>10000hours</td> </tr> </table>		SIZE	φ D≤6.3	φ D = 8,10	φ D ≥ 13	Voltage	6.3~10WV	4000 hours	6000 hours	8000 hours	16~100WV	5000 hours	7000 hours	10000hours													
		SIZE	φ D≤6.3	φ D = 8,10	φ D ≥ 13																							
	Voltage	6.3~10WV	4000 hours	6000 hours	8000 hours																							
16~100WV		5000 hours	7000 hours	10000hours																								
Ambient temperature	:+105°C																											
Applied voltage	:Rated DC working voltage																											
After test requirement at +20°C																												
Capacitance change	: within ±25% of the initial measured value																											
Dissipation factor	: ≤200% of the initial specified value																											
Leakage current	: ≤The initial specified value																											
Shelf Life	Test condition																											
	Duration time	:1000Hrs																										
	Ambient temperature	:+105°C																										
	Applied voltage	:None																										
After test requirement at +20°C	:Same limits as Endurance.																											
Pre-treatment for measurements shall be conducted after application of DC working voltage for 30 minutes.																												

Multiplier for Ripple Current vs. Frequency

CAP(µF)\Hz	50(60)	120	400	1K	10K	100K
CAP ≤ 10	0.47	0.59	0.76	0.85	0.97	1.00
10 < CAP ≤ 100	0.52	0.62	0.80	0.89	0.97	1.00
100 < CAP ≤ 1000	0.58	0.72	0.84	0.90	0.98	1.00
1000 < CAP	0.63	0.78	0.87	0.91	0.98	1.00

Diagram of Dimensions:(unit:mm)

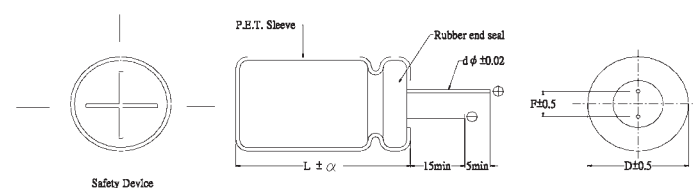

φ D	5	6.3	8	10	13	16	18
F	2.0	2.5	3.5	5.0	5.0	7.5	7.5
φ d	0.5	L < 20	L ≥ 20	0.6	0.6	0.8	0.8
		0.5	0.6				
α	D < 16	D=16		D=18		D > 18	
	1.5	L:25~35.5	L < 25 and L ≥ 40	L:25~31.5	L < 25 and L ≥ 35.5	2.0	2.0

Case Size

WV (Vdc)	Cap (uF)	Size (mm)	Ripple current (mA rms/105°C /100KHz)	Max ESR(Ω) at 20°C/100KHz
6.3	150	5x11	220	0.550
6.3	220	6.3x11	300	0.260
6.3	330	6.3x11	350	0.210
6.3	470	8x11.5	440	0.140
6.3	680	8x11.5	650	0.130
6.3	820	10x12.5	870	0.090
6.3	1000	8x16	850	0.080
6.3	1200	8x20	1060	0.075
6.3	1200	10x16	1220	0.064
6.3	1500	10x20	1410	0.050
6.3	1800	13x16	1460	0.049
6.3	2200	10x25	1660	0.046
6.3	2700	16x16	1950	0.042
6.3	3300	13x20	1910	0.038
6.3	3900	13x25	2240	0.029
6.3	3900	18x16	2220	0.040
6.3	4700	13x30	2660	0.027
6.3	5600	13x35	2890	0.024
6.3	5600	16x20	2540	0.027
6.3	6800	13x40	3360	0.017
6.3	6800	16x25	2940	0.021
6.3	6800	18x20	2870	0.026
6.3	8200	16x31.5	3460	0.017
6.3	10000	16x35.5	3620	0.015
6.3	10000	18x25	3150	0.019
6.3	12000	16x40	4090	0.013
6.3	12000	18x31.5	4180	0.015
6.3	15000	18x35.5	4230	0.014
6.3	18000	18x40	4290	0.012
10	100	5x11	220	0.580
10	220	6.3x11	350	0.230
10	330	6.3x11	450	0.220
10	470	8x11.5	650	0.130
10	680	8x16	850	0.096
10	680	10x12.5	870	0.085
10	820	10x16	950	0.075
10	1000	8x20	1060	0.072
10	1000	10x16	1220	0.064
10	1200	10x20	1410	0.045
10	1500	10x25	1560	0.043
10	1500	13x16	1460	0.049
10	2200	10x30	1920	0.030
10	2200	13x20	1910	0.035
10	2200	16x16	1950	0.042
10	2700	18x16	2220	0.043
10	3300	13x25	2240	0.029
10	3900	13x30	2660	0.025
10	3900	16x20	2540	0.027
10	4700	13x35	2890	0.020
10	5600	13x40	3360	0.017
10	5600	16x25	2940	0.021
10	5600	18x20	2870	0.026
10	6800	16x31.5	3460	0.017
10	6800	18x25	3150	0.019
10	8200	16x35.5	3620	0.015
10	8200	18x31.5	4180	0.015
10	10000	16x40	4090	0.013
10	10000	18x35.5	4230	0.014
10	12000	18x40	4290	0.012

WV (Vdc)	Cap (uF)	Size (mm)	Ripple current (mA rms/105°C /100KHz)	Max ESR(Ω) at 20°C/100KHz
16	56	5x11	220	0.560
16	100	6.3x11	300	0.220
16	120	6.3x11	350	0.215
16	220	8x11.5	500	0.180
16	330	8x11.5	650	0.140
16	470	8x11.5	740	0.100
16	470	8x16	850	0.095
16	470	10x12.5	870	0.085
16	680	8x20	1060	0.080
16	680	10x16	1220	0.060
16	820	10x20	1300	0.052
16	1000	10x20	1410	0.046
16	1000	13x16	1460	0.050
16	1200	10x25	1660	0.044
16	1500	10x25	1770	0.036
16	1500	10x30	1920	0.031
16	1500	13x20	1910	0.037
16	1500	16x16	1950	0.042
16	1800	10x25	1800	0.036
16	1800	13x25	2080	0.030
16	2200	13x25	2240	0.026
16	2200	18x16	2220	0.043
16	2700	13x30	2660	0.023
16	2700	16x20	2540	0.027
16	3300	13x35	2890	0.022
16	3900	13x40	3360	0.017
16	3900	16x25	2940	0.021
16	3900	18x20	2870	0.026
16	4700	16x31.5	3460	0.017
16	4700	18x25	3150	0.020
16	5600	16x35.5	3620	0.015
16	5600	18x31.5	4180	0.015
16	6800	16x40	4090	0.013
16	8200	18x35.5	4230	0.014
16	10000	18x40	4290	0.012
25	47	5x11	220	0.560
25	56	5x11	260	0.560
25	100	6.3x11	350	0.250
25	220	8x11.5	650	0.150
25	330	8x16	850	0.092
25	330	10x12.5	870	0.082
25	470	8x20	1060	0.074
25	470	10x12.5	1100	0.074
25	470	10x16	1220	0.068
25	680	10x20	1410	0.050
25	680	13x16	1460	0.049
25	820	10x25	1660	0.041
25	1000	10x30	1920	0.032
25	1000	13x20	1910	0.036
25	1000	16x16	1950	0.042
25	1200	18x16	2220	0.043
25	1500	13x25	2240	0.028
25	1800	13x30	2660	0.024
25	1800	16x20	2540	0.027
25	2200	13x30	2695	0.025
25	2200	13x35	2890	0.023
25	2200	18x20	2870	0.026
25	2700	13x40	3360	0.017
25	2700	16x25	2940	0.022

WV (Vdc)	Cap (uF)	Size (mm)	Ripple current (mAmps/105°C /100KHz)	Max ESR(Ω) at 20°C/100KHz
25	3300	16x31.5	3460	0.017
25	3300	18x25	3150	0.019
25	3900	16x35.5	3620	0.015
25	3900	18x31.5	4180	0.015
25	4700	16x40	4090	0.013
25	4700	18x35.5	4230	0.014
25	5600	18x40	4290	0.012
35	33	5x11	230	0.550
35	47	5x11	300	0.450
35	56	6.3x11	360	0.210
35	100	6.3x11	480	0.180
35	150	8x11.5	680	0.140
35	220	8x11.5	870	0.095
35	220	8x16	1000	0.090
35	220	10x12.5	1060	0.080
35	270	8x20	1180	0.070
35	330	10x16	1380	0.062
35	470	10x20	1800	0.048
35	470	13x16	1560	0.049
35	560	10x25	1900	0.042
35	680	10x30	2000	0.035
35	680	13x20	2100	0.034
35	680	16x16	2050	0.042
35	1000	13x20	2180	0.038
35	1000	13x25	2400	0.028
35	1000	18x16	2220	0.043
35	1200	13x30	2800	0.024
35	1200	16x20	2800	0.028
35	1500	13x35	3000	0.022
35	1800	13x40	3360	0.017
35	1800	16x25	2940	0.020
35	1800	18x20	2870	0.026
35	2200	16x31.5	3460	0.017
35	2200	18x20	2930	0.025
35	2200	18x25	3150	0.019
35	2700	16x35.5	3620	0.018
35	2700	18x31.5	4180	0.016
35	3300	16x40	4090	0.013
35	3300	18x35.5	4230	0.014
35	3900	18x40	4300	0.012
50	22	5x11	220	0.650
50	47	6.3x11	270	0.370
50	56	6.3x11	300	0.290
50	100	8x11.5	680	0.160
50	120	8x16	760	0.120
50	150	10x12.5	800	0.120
50	180	8x20	1000	0.090
50	220	10x16	1300	0.082
50	270	10x20	1350	0.060
50	270	13x16	1270	0.061
50	330	10x25	1600	0.057
50	470	10x30	1800	0.048
50	470	13x20	1740	0.045
50	470	16x16	1710	0.055
50	560	13x25	1960	0.042
50	560	18x16	1940	0.054
50	680	13x30	2320	0.030
50	820	13x35	2520	0.025
50	820	16x20	2220	0.034
50	1000	13x35	2650	0.024
50	1000	13x40	2930	0.021

WV (Vdc)	Cap (uF)	Size (mm)	Ripple current (mAmps/105°C /100KHz)	Max ESR(Ω) at 20°C/100KHz
50	1000	16x25	2565	0.025
50	1000	18x20	2500	0.036
50	1200	16x31.5	3020	0.030
50	1200	18x25	2750	0.026
50	1500	16x35.5	3160	0.019
50	1800	16x40	3720	0.016
50	1800	18x31.5	3645	0.021
50	2200	18x35.5	3690	0.017
50	2700	18x40	3810	0.014
50	3300	18x40	3810	0.014
63	15	5x11	65	1.800
63	33	6.3x11	260	1.200
63	47	8x11.5	360	0.660
63	56	8x11.5	380	0.600
63	82	8x16	460	0.440
63	82	10x12.5	500	0.430
63	100	10x12.5	640	0.340
63	120	8x20	700	0.320
63	120	10x16	760	0.300
63	180	10x20	880	0.190
63	180	13x16	800	0.180
63	220	10x20	995	0.188
63	220	10x25	1100	0.185
63	270	10x30	1200	0.120
63	270	13x20	1200	0.160
63	270	16x16	1200	0.110
63	330	13x25	1600	0.120
63	390	18x16	1610	0.096
63	470	13x30	1800	0.100
63	470	16x20	1500	0.077
63	560	13x35	2000	0.070
63	560	16x25	2000	0.073
63	680	13x40	2200	0.070
63	680	18x20	1600	0.072
63	820	16x31.5	2400	0.054
63	820	18x25	1800	0.052
63	1000	16x35.5	2500	0.048
63	1000	18*25	2290	0.052
63	1000	18x31.5	2800	0.047
63	1200	16x40	2920	0.040
63	1200	18x31.5	2850	0.045
63	1200	18x35.5	3000	0.039
63	1500	18x40	3200	0.036
100	6.8	5x11	65	1.800
100	15	6.3x11	130	1.000
100	27	8x11.5	300	0.610
100	39	8x16	340	0.360
100	47	10x12.5	400	0.420
100	56	8x20	410	0.260
100	68	10x16	460	0.300
100	82	10x20	600	0.210
100	82	13x16	540	0.180
100	100	10x25	800	0.200
100	120	10x30	830	0.120
100	120	13x20	900	0.160
100	150	13x20	1000	0.110
100	150	16x16	1000	0.110
100	180	13x25	1010	0.096
100	180	18x16	1180	0.096
100	220	13x30	1210	0.080
100	220	16x20	1140	0.077

WV (Vdc)	Cap (uF)	Size (mm)	Ripple current (mA _{rms} /105°C /100KHz)	Max ESR(Ω) at 20°C/100KHz
100	270	13x35	1450	0.070
100	270	16x25	1480	0.073
100	330	13x40	1600	0.071
100	330	18x20	1400	0.072
100	390	16x31.5	1700	0.055
100	390	18x25	1740	0.054

WV (Vdc)	Cap (uF)	Size (mm)	Ripple current (mA _{rms} /105°C /100KHz)	Max ESR(Ω) at 20°C/100KHz
100	470	16x35.5	1910	0.047
100	470	18x31.5	1730	0.047
100	560	16x40	2140	0.036
100	680	18x35.5	2000	0.042
100	820	18x40	2480	0.040
100	1000	18x40	2580	0.038

ZH 105°C Miniaturized, Long Life, Low impedance

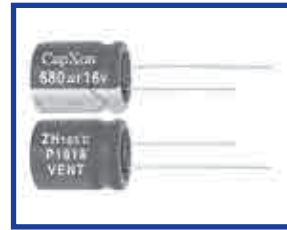

Features

- ◆ Long Life: 105°C 6000~10000 hours.
- ◆ RoHS compliance.

Specifications

Item	Performance Characteristics																														
Operating Temperature Range	-40 to +105°C																														
Rated Voltage Range	6.3~100V.DC																														
Capacitance Range	2.2~8200 μF																														
Capacitance Tolerance	±20%(120Hz,+20°C)																														
Leakage Current (+20°C,max.)	$I \leq 0.01CV$ or $3\mu A$ whichever is greater. (After 2 minutes) I= Leakage Current(μA) C= Rated Capacitance V= Rated voltage(V)																														
Dissipation Factor (tan δ , at 20°C , 120Hz)	<table border="1"> <tr> <th>Working Voltage(VDC)</th> <td>6.3</td> <td>10</td> <td>16</td> <td>25</td> <td>35</td> <td>50</td> <td>63</td> <td>80</td> <td>100</td> </tr> <tr> <th>D. F.(%) max.</th> <td>22</td> <td>19</td> <td>16</td> <td>14</td> <td>12</td> <td>10</td> <td>9</td> <td>8</td> <td>8</td> </tr> </table>	Working Voltage(VDC)	6.3	10	16	25	35	50	63	80	100	D. F.(%) max.	22	19	16	14	12	10	9	8	8										
	Working Voltage(VDC)	6.3	10	16	25	35	50	63	80	100																					
D. F.(%) max.	22	19	16	14	12	10	9	8	8																						
For capacitance > 1000μF, add 2% per another 1000μF.																															
Low Temperature Characteristics (at 120Hz)	Impedance ratio max																														
	<table border="1"> <tr> <th>Working Voltage(VDC)</th> <td>6.3</td> <td>10</td> <td>16</td> <td>25</td> <td>35</td> <td>50</td> <td>63</td> <td>80</td> <td>100</td> </tr> <tr> <th>Z-25°C / Z+20°C</th> <td>2</td> <td>2</td> <td>2</td> <td>2</td> <td>2</td> <td>2</td> <td>2</td> <td>2</td> <td>2</td> </tr> <tr> <th>Z-40°C / Z+20°C</th> <td>3</td> <td>3</td> <td>3</td> <td>3</td> <td>3</td> <td>3</td> <td>3</td> <td>3</td> <td>3</td> </tr> </table>	Working Voltage(VDC)	6.3	10	16	25	35	50	63	80	100	Z-25°C / Z+20°C	2	2	2	2	2	2	2	2	2	Z-40°C / Z+20°C	3	3	3	3	3	3	3	3	3
	Working Voltage(VDC)	6.3	10	16	25	35	50	63	80	100																					
Z-25°C / Z+20°C	2	2	2	2	2	2	2	2	2																						
Z-40°C / Z+20°C	3	3	3	3	3	3	3	3	3																						
For capacitance > 1000 μ F, add 0.5 per another 1000 μ F for -25°C/+20°C. add 1 per another 1000 μ F for -40°C/+20°C.																															
Endurance	Test conditions Duration time : as right Ambient temperature : +105°C Applied voltage : Rated DC working voltage After test requirement at +20°C Capacitance change : $\leq \pm 25\%$ of the initial measured value.(6.3V,10V: $\pm 30\%$) Dissipation factor : $\leq 200\%$ of the initial specified value Leakage current : \leq The initial specified value																														
	<table border="1"> <tr> <th>D Φ</th> <th>Life hours</th> </tr> <tr> <td>Φ D ≤ 6.3</td> <td>6000</td> </tr> <tr> <td>Φ D = 8</td> <td>8000</td> </tr> <tr> <td>Φ D ≥ 10</td> <td>10000</td> </tr> </table>	D Φ	Life hours	Φ D ≤ 6.3	6000	Φ D = 8	8000	Φ D ≥ 10	10000																						
D Φ	Life hours																														
Φ D ≤ 6.3	6000																														
Φ D = 8	8000																														
Φ D ≥ 10	10000																														
Shelf Life	Test condition Duration time : 1000Hrs Ambient temperature : +105°C Applied voltage : None After test requirement at +20°C: Same limits as Endurance. Pre-treatment for measurements shall be conducted after application of DC working voltage for 30 minutes.																														

Multiplier for Ripple Current vs. Frequency

CAP(μ F)\Frequency(Hz)	120	1K	10K	100K ≤
8.2~33 μ F	0.42	0.70	0.90	1.00
47~270 μ F	0.50	0.73	0.92	1.00
330~680 μ F	0.55	0.77	0.94	1.00
820~1800 μ F	0.60	0.80	0.96	1.00
2200~8200 μ F	0.70	0.85	0.98	1.00

Diagram of Dimensions:(unit:mm)

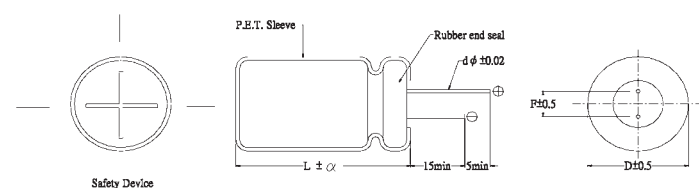

φ D	5	6	8	10	13	16	18
F	2.0	3.0	3.5	5.0	5.0	7.5	7.5
φ d	0.5		L < 20	L ≥ 20	0.6		0.8
			0.5	0.6			
α	D = 16		D = 18		D > 18		2.0
	D < 16	L: 25~35.5	L < 25 and L ≥ 40	L: 25~31.5			
	1.5	1.5	2.0	1.5	2.0		

Case Size

WV (Vdc)	Cap (uF)	Size (mm)	Ripple current (mA _{rms} /105°C /100KHz)	Max ESR(Ω) at 20°C/100KHz
6.3	220	5x11	355	0.230
6.3	470	6.3x11	550	0.100
6.3	820	8x11.5	955	0.060
6.3	1200	8x16	1260	0.050
6.3	1200	10x12.5	1340	0.044
6.3	1500	8x20	1510	0.034
6.3	1800	10x16	1770	0.033
6.3	2200	10x20	1970	0.025
6.3	2700	10x25	2260	0.023
6.3	3900	13x20	2490	0.022
6.3	4700	13x25	2910	0.020
6.3	5600	13x30	3460	0.018
6.3	6800	13x35	3580	0.017
6.3	6800	16x20	3260	0.020
6.3	8200	16x25	3640	0.018
10	150	5x11	355	0.230
10	330	6.3x11	550	0.100
10	680	8x11.5	955	0.060
10	1000	8x16	1260	0.050
10	1000	10x12.5	1340	0.049
10	1500	8x20	1510	0.034
10	1500	10x16	1770	0.033
10	1800	10x20	1970	0.025
10	2200	10x25	2260	0.023
10	2700	13x20	2440	0.022
10	3300	13x20	2490	0.021
10	3900	13x25	2910	0.020
10	4700	13x30	3460	0.018
10	4700	16x20	3260	0.020
10	5600	13x35	3580	0.017
10	6800	16x25	3640	0.018
16	100	5x11	355	0.230
16	220	6.3x11	550	0.100
16	470	8x11.5	955	0.060
16	680	8x16	1260	0.050
16	680	10x12.5	1340	0.044
16	1000	8x20	1510	0.034
16	1000	10x16	1770	0.033
16	1500	10x20	1970	0.025
16	1800	10x25	2260	0.023
16	2200	13x20	2490	0.022
16	2700	13x25	2910	0.020
16	3300	13x30	3460	0.018
16	3300	16x20	3260	0.023
16	3900	13x35	3580	0.017
16	4700	16x25	3640	0.018
25	68	5x11	355	0.240
25	150	6.3x11	550	0.100
25	330	8x11.5	955	0.060
25	390	8x16	1260	0.050
25	470	10x12.5	1340	0.044
25	560	8x20	1510	0.034
25	680	10x16	1770	0.033
25	820	10x20	1970	0.025
25	1000	10x20	2045	0.024
25	1000	10x25	2260	0.023
25	1500	13x20	2490	0.022
25	1800	13x25	2910	0.020
25	2200	13x30	3460	0.018

WV (Vdc)	Cap (uF)	Size (mm)	Ripple current (mA _{rms} /105°C /100KHz)	Max ESR(Ω) at 20°C/100KHz
25	2200	16x20	3260	0.020
25	2700	13x35	3580	0.017
25	3300	16x25	3640	0.018
35	47	5x11	355	0.500
35	100	6.3x11	550	0.110
35	220	8x11.5	955	0.062
35	270	8x16	1260	0.060
35	330	10x12.5	1340	0.043
35	390	8x20	1510	0.032
35	470	10x16	1770	0.033
35	560	10x20	1970	0.030
35	680	10x25	2260	0.028
35	820	10x25	2360	0.027
35	1000	10x30	2580	0.025
35	1000	13x20	2490	0.022
35	1200	13x25	2910	0.018
35	1500	13x30	3460	0.018
35	1500	16x20	3260	0.023
35	1800	13x35	3580	0.017
35	2200	16x25	3640	0.018
50	27	5x11	248	0.400
50	56	6.3x11	395	0.150
50	100	8x11.5	755	0.110
50	120	8x16	960	0.065
50	150	10x12.5	989	0.067
50	180	8x20	1200	0.051
50	220	10x16	1380	0.046
50	270	10x20	1590	0.033
50	330	10x20	1600	0.033
50	330	10x25	1880	0.032
50	470	13x20	2060	0.032
50	560	13x25	2420	0.028
50	680	13x30	2870	0.026
50	820	13x35	2970	0.024
50	820	16x20	2740	0.028
50	1000	16x25	3020	0.026
63	18	5x11	183	0.980
63	47	6.3x11	288	0.600
63	82	8x11.5	535	0.300
63	100	8x16	698	0.200
63	120	10x12.5	735	0.165
63	150	8x20	871	0.140
63	180	10x16	1008	0.130
63	220	10x20	1110	0.120
63	270	10x20	1210	0.086
63	270	13x16	1210	0.090
63	270	13x20	1330	0.088
63	330	10x25	1420	0.076
63	330	13x25	1610	0.073
63	390	13x20	1580	0.066
63	470	13x25	2000	0.048
63	470	13x30	2170	0.046
63	470	16x20	2090	0.047
63	560	13x30	2420	0.040
63	560	16x20	2110	0.048
63	680	13x35	2630	0.038
63	820	13x40	2950	0.032
63	820	16x25	2740	0.037
63	820	18x20	2510	0.043

WV (Vdc)	Cap (uF)	Size (mm)	Ripple current (mArms/105°C /100KHz)	Max ESR(Ω) at 20°C/100KHz
63	1200	16x31.5	3000	0.029
63	1200	18x25	2810	0.036
63	1500	16x35.5	3050	0.026
63	1500	18x31.5	3310	0.030
63	1800	16x40	3580	0.024
63	1800	18x35.5	3580	0.025
63	2200	18x40	3680	0.023
80	12	5x11	173	1.540
80	33	6.3x11	277	0.630
80	56	8x11.5	472	0.400
80	68	8x16	595	0.280
80	82	10x12.5	634	0.250
80	100	8x20	745	0.210
80	120	10x16	790	0.187
80	180	10x20	1050	0.130
80	180	13x16	985	0.140
80	220	10x25	1180	0.120
80	270	13x20	1440	0.094
80	330	13x25	1630	0.066
80	390	13x30	1960	0.056
80	390	16x20	1760	0.064
80	470	13x35	2150	0.047
80	560	13x40	2350	0.045
80	560	16x25	2220	0.049
80	560	18x20	1960	0.059
80	680	16x31.5	2410	0.038
80	820	16x35.5	2610	0.032
80	820	18x25	2280	0.042
80	1000	16x40	2870	0.033

WV (Vdc)	Cap (uF)	Size (mm)	Ripple current (mArms/105°C /100KHz)	Max ESR(Ω) at 20°C/100KHz
80	1000	18x31.5	2480	0.036
80	1200	18x35.5	2870	0.033
80	1500	18x40	3520	0.032
100	8.2	5x11	173	1.540
100	18	6.3x11	277	0.627
100	33	8x11.5	472	0.420
100	47	8x16	595	0.400
100	56	10x12.5	634	0.350
100	68	8x20	745	0.300
100	82	10x16	790	0.220
100	100	10x20	1050	0.150
100	100	13x16	985	0.160
100	120	10x25	1180	0.140
100	150	13x20	1440	0.094
100	220	13x25	1660	0.066
100	270	13x30	1960	0.056
100	270	16x20	1760	0.064
100	330	13x35	2150	0.047
100	390	13x40	2350	0.040
100	390	16x25	2220	0.049
100	390	18x20	1960	0.059
100	470	16x31.5	2410	0.036
100	470	18x25	2280	0.042
100	560	16x35.5	2610	0.032
100	560	18x31.5	2480	0.034
100	680	16x40	2870	0.030
100	680	18x35.5	2870	0.030
100	820	18x40	3520	0.029

KL Series Long Life 5,000 hrs



Features

- ◆ Used in electronic ballast, switching power supply, industrial measuring instruments.
- ◆ Endurance 5000 Hrs at 105°C
- ◆ Safety vent construction design.
- ◆ RoHS Compliant

Specifications

Item	Performance Characteristics		
Operating Temperature Range	-40 to +105°C	-25 to +105°C	
Rated Voltage Range	160 to 400 VDC	450 to 500 VDC	
Capacitance Range	3.3 to 330 μF	2.2 to 180 μF	
Capacitance Tolerance	±20%(120Hz,+20°C)		
Leakage Current (+20°C,max.)	(CV ≤ 1000) I ≤ 0.1CV+40(μA)	(CV > 1000) I ≤ 0.04CV+100(μA)	
Dissipation Factor (tan δ, at 20°C, 120Hz)	After 1 minute with rated working voltage applied. C: rated Capacitance (μF) · V: working voltage(V)		
Low Temperature Characteristics (at 120Hz)	Working Voltage(VDC)	160 200 250 350 400 450 500	
	D. F.(%) max.	12 12 12 15 15 17 20	
Endurance	Test conditions	Impedance ratio max	
	Duration time : 5000Hrs Ambient temperature : +105°C Applied voltage : Rated DC working voltage	Working Voltage(VDC)	160 200 250 350 400 450 500
Shelf Life	After test requirement at +20°C	Z-25°C / Z+20°C	3 3 3 6 6 6 6
	Capacitance change : ≤ ±20% of the initial measured value Dissipation factor : ± 200% of the initial specified value Leakage current : ± The initial specified value	Test conditions	
	Duration time : 1000Hrs Ambient temperature : +105°C Applied voltage : None	After test requirement at +20°C: Same limits as Endurance. Pre-treatment for measurements shall be conducted after application of DC working voltage for 30 minutes.	

Radial

Multiplier for Ripple Current vs. Frequency

Frequency(Hz)	120	1K	10K	≥50K
Multiplier	1	1.5	1.7	1.9

Diagram of Dimensions:(unit:mm)

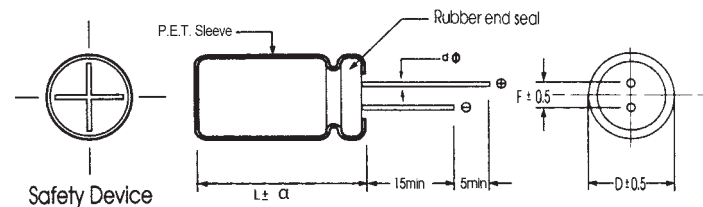

φD	10	13	16	18	22	
F	5.0	5.0	7.5	7.5	10	
φd	0.6		0.8			
α	D < 16	D = 16		D = 18		D > 18
	L: 25~35.5	L < 25 and L ≥ 40	L: 25~31.5	L < 25 and L ≥ 35.5		
	1.5	1.5	2.0	1.5	2.0	2.0

Case Size

WV (Vdc)	Cap (uF)	Size (mm)	Rated Ripple current (mA _{rms} /105°C /120Hz)
160	3.3	10x12.5	52
160	4.7	10x12.5	60
160	10	10x12.5	104
160	10	10x16	115
160	15	10x16	150
160	22	10x16	190
160	22	10x20	210
160	33	10x16	235
160	33	10x20	258
160	33	13x20	300
160	47	10x20	270
160	47	13x20	310
160	68	13x20	430
160	68	13x25	470
160	100	13x25	540
160	100	16x20	540
160	100	16x25	590
160	120	16x20	560
160	150	16x25	650
160	180	16x31.5	750
160	220	16x31.5	820
160	220	18x25	710
160	270	18x31.5	880
160	330	18x31.5	930
160	330	18x40	1000
200	3.3	10x12.5	52
200	4.7	10x12.5	60
200	6.8	10x12.5	70
200	10	10x12.5	104
200	10	10x16	115
200	10	10x20	125
200	15	10x16	150
200	22	10x16	210
200	22	10x20	230
200	33	10x20	290
200	33	13x20	350
200	47	13x20	380
200	68	13x25	530
200	68	16x20	530
200	100	16x20	570
200	100	16x25	610
200	120	16x25	700
200	150	16x25	700
200	150	16x31.5	750
200	180	18x31.5	830
200	220	18x31.5	970
200	270	18x40	1100
200	330	18x45	1250
250	4.7	10x12.5	60
250	6.8	10x12.5	75
250	10	10x16	160
250	10	10x20	170
250	15	10x16	180
250	22	10x20	250
250	22	13x20	290
250	33	13x20	360
250	33	13x25	380
250	47	13x25	430
250	68	16x20	530
250	68	16x25	550

WV (Vdc)	Cap (uF)	Size (mm)	Rated Ripple current (mA _{rms} /105°C /120Hz)
250	68	18x20	550
250	100	16x25	630
250	100	16x31.5	700
250	100	18x25	680
250	100	18x31.5	750
250	120	18x31.5	790
250	150	18x31.5	840
250	150	18x35.5	880
250	180	18x40	980
250	220	18x35.5	960
250	220	18x40	1020
350	4.7	10x12.5	65
350	6.8	10x16	100
350	10	10x20	170
350	10	13x20	180
350	15	13x20	200
350	22	13x20	290
350	33	13x25	320
350	33	16x20	320
350	47	16x25	430
350	47	16x31.5	440
350	68	16x35.5	550
350	100	18x31.5	750
350	100	18x35.5	780
400	3.3	10x12.5	55
400	4.7	10x16	100
400	6.8	10x16	120
400	6.8	10x20	125
400	10	10x16	156
400	10	10x20	170
400	10	13x20	200
400	15	10x16	156
400	15	13x20	200
400	22	13x25	320
400	22	16x20	320
400	33	16x20	400
400	33	16x25	430
400	47	16x20	420
400	47	16x25	450
400	47	16x31.5	530
400	68	16x25	480
400	68	16x31.5	530
400	82	16x31.5	580
400	100	16x31.5	710
400	100	18x35.5	750
400	120	16x35.5	800
400	120	18x31.5	800
400	150	16x40	920
400	150	18x31.5	890
400	180	18x40	1060
400	220	18x45	1200
450	2.2	10x12.5	45
450	3.3	10x16	65
450	4.7	10x12.5	95
450	4.7	10x16	105
450	6.8	10x16	125
450	6.8	10x20	140
450	10	10x20	170
450	10	13x20	190
450	10	13x25	220

WV (Vdc)	Cap (uF)	Size (mm)	Rated Ripple current (mAmps/105°C /120Hz)
450	15	16x20	270
450	22	13x20	280
450	22	16x20	320
450	22	16x25	360
450	33	16x25	440
450	33	18x25	460
450	47	16x31.5	480
450	47	18x25	450
450	56	16x31.5	530
450	68	16x35.5	600
450	68	18x25	580
450	68	18x31.5	620
450	82	16x35.5	680
450	100	16x35.5	750
450	120	18x35.5	840
450	150	18x40	970
450	180	18x45	1090

WV (Vdc)	Cap (uF)	Size (mm)	Rated Ripple current (mAmps/105°C /120Hz)
500	4.7	13x20	82
500	6.8	13x20	96
500	10	13x25	130
500	22	16x25	210
500	33	16x31.5	280
500	47	16x35.5	360
500	47	18x31.5	360
500	56	16x40	420
500	56	18x31.5	400
500	68	16x45	480
500	68	18x35.5	460
500	68	18x40	490
500	82	18x40	540
500	100	18x45	630
500	100	20x40	660
500	120	22x45	800

KH Series Long Life 5,000~10,000 hrs



Features

- ◆ Used in electronic ballast, switching power supply, industrial measuring instruments.
- ◆ higher ripple current
- ◆ Endurance 5000~10000 Hrs at 105°C
- ◆ Safety vent construction design.
- ◆ RoHS Compliant

Specifications

Item	Performance Characteristics												
Operating Temperature Range	-40 to +105°C	-25 to +105°C											
Rated Voltage Range	10 to 400 VDC	450 VDC											
Capacitance Range	6.8 to 3300 µF	6.8 to 100 µF											
Capacitance Tolerance	±20%(120Hz,+20°C)												
Leakage Current (+20°C,max.)	$I \leq 0.01 CV$ or $3 (\mu A)$	$I \leq 0.04 CV+100 (\mu A)$											
	After 1 minute with rated working voltage applied. I =Leakage Current(μA) C =Rated capacitance(μF) V =Rated Voltage(V)												
Dissipation Factor ($\tan \delta$ at 20°C, 120Hz)	Working voltage(VDC)	10 16 25 35 50 160 200 250 350 400 450											
	D.F.(%)max.	19 16 14 12 10 15 15 15 20 20 20											
Low Temperature Characteristics (at 120Hz)	Impedance ratio max												
	Working voltage(VDC)	10 16 25 35 50 160 200 250 350 400 450											
	Z-25°C / Z+20°C	4 3 2 2 2 3 3 3 6 6 6											
Z-40°C / Z+20°C	6 4 3 3 3 6 6 6 6 6 6												
	Endurance												
Endurance	Test conditions										D φ		Life (hours)
	Duration time : as right Ambient temperature : +105°C Applied voltage : Rated DC working voltage										< 8 φ	5000	
After test requirement at +20°C										8 φ	8000		
Capacitance change : ≤ ±20% of the initial measured value										≥ 10 φ	10000		
Dissipation factor : ≤ 200% of the initial specified value													
Leakage current : ≤ The initial specified value													
Shelf Life	Test conditions												
	Duration time : 1000Hrs Ambient temperature : +105°C Applied voltage : None												
After test requirement at +20°C: Same limits as Endurance.													
Pre-treatment for measurements shall be conducted after application of DC working voltage for 30 minutes.													

Multiplier for Ripple Current vs. Frequency

Frequency(Hz)	120	1K	10K	≥ 100K
Multiplier	0.50	0.80	0.85	1.0

Diagram of Dimensions:(unit:mm)

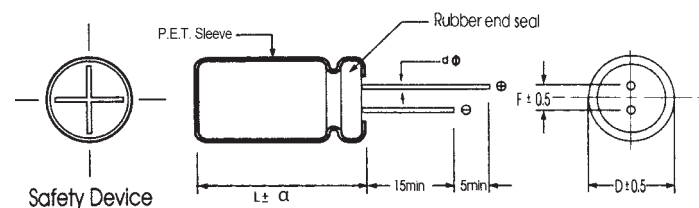

φ D	5	6.3	8	10	13	16	18
F	2.0	2.5	3.5	5.0	5.0	7.5	7.5
φ d	0.5		0.6		0.8		
α	D=16		D=18		D>18		
	D<16	L:25~35.5	L<25 and L≥40	L:25~31.5	L<25 and L≥35.5		
	1.5	1.5	2.0	1.5	2.0	2.0	

Case Size

WV (Vdc)	Cap (uF)	Size (mm)	Rated Ripple current (mArms/105°C /100KHz)
10	47	5x11	100
10	68	5x11	130
10	100	6.3x11	190
10	150	6.3x11	220
10	220	6.3x11	270
10	330	6.3x11	334
10	330	8x11.5	390
10	470	8x11.5	458
10	470	10x12.5	540
10	1000	8x20	878
10	1000	10x12.5	810
10	1000	10x16	900
10	2200	13x16	1401
10	2200	13x20	1540
10	3300	13x20	1533
10	3300	16x25	1900
16	33	5x11	115
16	47	5x11	145
16	68	6.3x11	200
16	100	6.3x11	210
16	100	8x11.5	245
16	150	6.3x11	257
16	150	8x11.5	300
16	220	6.3x11	360
16	220	8x11.5	420
16	220	10x12.5	495
16	330	8x11.5	433
16	330	8x16	500
16	470	8x11.5	558
16	470	10x12.5	657
16	470	10x16	730
16	1000	10x20	1012
16	1000	13x20	1173
16	2200	13x20	1689
16	2200	13x25	1862
16	2200	16x25	2093
25	22	5x11	100
25	33	5x11	130
25	47	6.3x11	160
25	68	6.3x11	197
25	68	8x11.5	230
25	100	6.3x11	280
25	100	8x11.5	327
25	150	8x11.5	390
25	150	10x12.5	460
25	220	8x11.5	443
25	220	10x16	580
25	330	8x16	644
25	330	10x12.5	657
25	330	10x16	730
25	330	10x20	805
25	470	10x16	861
25	470	10x20	950
25	1000	13x20	1408
25	1000	13x25	1552
25	2200	16x25	2169
25	2200	16x31.5	2400
35	10	5x11	65
35	22	5x11	125
35	33	5x11	160

WV (Vdc)	Cap (uF)	Size (mm)	Rated Ripple current (mArms/105°C /100KHz)
35	33	6.3x11	178
35	47	5x11	180
35	47	6.3x11	206
35	47	8x11.5	240
35	68	6.3x11	231
35	68	8x11.5	270
35	100	8x11.5	331
35	100	10x12.5	390
35	150	8x11.5	483
35	150	8x16	558
35	150	10x16	632
35	220	8x16	610
35	220	10x16	689
35	220	10x20	760
35	330	10x16	810
35	330	10x20	893
35	330	13x20	1035
35	470	10x16	781
35	470	10x20	861
35	470	13x20	998
35	470	13x25	1100
35	820	10x25	1300
35	1000	13x20	1409
35	1000	13x25	1554
35	1000	16x25	1746
35	1000	16x31.5	1932
50	6.8	5x11	75
50	10	5x11	97
50	22	6.3x11	130
50	33	6.3x11	210
50	33	8x11.5	241
50	47	6.3x11	246
50	47	8x11.5	287
50	47	10x12.5	300
50	68	8x11.5	302
50	68	10x12.5	356
50	100	8x11.5	382
50	100	10x16	500
50	150	10x12.5	610
50	150	10x16	677
50	150	10x20	747
50	220	10x16	764
50	220	10x20	843
50	220	13x20	977
50	330	13x20	1043
50	330	13x25	1150
50	470	13x20	1253
50	470	16x20	1441
50	470	16x25	1552
50	1000	16x25	1771
50	1000	16x31.5	1960
50	1000	18x31.5	2093
160	10	10x16	330
160	22	10x20	510
160	33	10x20	660
160	33	13x20	760
160	47	10x20	760
160	47	13x20	870
160	68	13x20	1190
160	68	13x25	1350

WV (Vdc)	Cap (uF)	Size (mm)	Rated Ripple current (mAmps/105°C /100KHz)
160	82	13x20	1280
160	100	13x25	1430
160	100	16x20	1430
160	100	18x20	1530
160	150	16x20	1900
160	150	18x25	2180
160	220	16x25	2380
160	220	18x25	2540
160	330	18x31.5	3140
200	10	10x16	330
200	10	10x20	360
200	22	10x20	510
200	33	10x20	660
200	33	13x20	760
200	47	13x20	990
200	68	13x20	1310
200	82	16x20	1390
200	100	16x20	1430
200	100	18x20	1530
200	150	16x25	1900
200	150	18x25	2030
200	220	18x25	2370
200	220	18x31.5	2620
200	330	18x35.5	3230
250	10	10x20	360
250	22	10x20	510
250	22	13x20	590
250	33	13x20	810
250	33	13x25	890
250	47	13x20	990
250	47	16x20	1130
250	68	16x20	1310
250	68	18x20	1400
250	82	16x20	1390
250	100	16x25	1540
250	100	18x25	1640
250	150	18x25	1950
250	150	18x31.5	2150
250	220	18x31.5	3140
350	6.8	10x16	290
350	6.8	10x20	310
350	10	10x20	360
350	10	13x20	410
350	22	13x20	660
350	22	13x25	720
350	33	16x20	910
350	47	16x20	1090

WV (Vdc)	Cap (uF)	Size (mm)	Rated Ripple current (mAmps/105°C /100KHz)
350	47	18x20	1160
350	68	16x25	1410
350	68	18x20	1380
350	68	18x25	1480
350	82	18x25	1540
350	100	18x25	1580
350	120	18x31.5	1870
350	150	18x35.5	2170
400	6.8	10x12.5	260
400	6.8	10x16	290
400	6.8	10x20	310
400	10	10x16	330
400	10	10x20	360
400	10	13x20	410
400	15	13x20	560
400	22	13x20	770
400	22	16x20	880
400	22	16x25	950
400	33	16x20	910
400	33	18x20	970
400	47	16x25	1190
400	47	18x20	1190
400	47	18x25	1270
400	68	18x25	1480
400	68	18x31.5	1630
400	82	18x25	1530
400	100	18x31.5	1730
400	120	18x35.5	1950
400	150	18x40	2220
450	6.8	10x20	290
450	6.8	13x20	330
450	10	13x20	460
450	10	13x25	500
450	15	13x20	550
450	15	13x25	610
450	22	13x25	710
450	22	16x20	760
450	22	16x25	790
450	33	16x25	990
450	33	18x20	990
450	33	18x25	1060
450	47	18x25	1210
450	47	18x31.5	1330
450	68	18x31.5	1580
450	82	18x35.5	1790
450	100	18x40	1810

TH Series High Temperature



Features

- ◆ The series has guaranteed operating life of 1000~3000 hours at 125°C widest operating temperature range, -40 to +125°C
- ◆ Applications : High reliability equipment, filtering circuit of switching power supply,
- ◆ RoHS Compliant

Specifications

Item	Performance Characteristics								
Operating Temperature Range	-40 to +125°C	-25 to +125°C							
Rated Voltage Range	10 to 400 VDC	450 VDC							
Capacitance Range	0.47 to 8200 µF	1 to 47 µF							
Capacitance Tolerance	±20%(120Hz,+20°C)								
Leakage Current (+20°C,max.)	10~100V	160~450V							
	I ≤ 0.01CV or 3uA	CV ≤ 1000 I ≤ 0.1CV+40(uA) CV > 1000 I ≤ 0.04CV+100(uA)							
	After 2 minute whichever is greater measured with rated working voltage applied	After 1 minute with rated working voltage applied.							
Dissipation Factor (tan δ · at 20°C · 120Hz)	Working Voltage(VDC)	10 16 25 35 50 63 80 100 160 200 250 350 400 450							
	D. F.(%) max.	18 15 13 12 10 8 8 7 12 12 12 15 15 20							
For capacitance > 1000 uF, add 2% per another 1000uF.									
Low Temperature Characteristics (at 120Hz)	Impedance ratio max								
	Working Voltage(VDC)	10 16 25 35 50 63 100 160~250 350~400 450							
	Z-25°C / Z+20°C	3 2 2 2 2 2 2 3 6 6							
	Z-40°C / Z+20°C	4 4 4 4 4 4 4 6 12							
Endurance	Test conditions								
	Duration time : 1000~3000Hrs Ambient temperature : +125°C Applied voltage : Rated DC working voltage After test requirement at +20°C Capacitance change : ≤ ±20% of the initial measured value Dissipation factor : ≤ 300% of the initial specified value Leakage current : ≤ The initial specified value	<table border="1"> <thead> <tr> <th>D φ</th> <th>Life hours</th> </tr> </thead> <tbody> <tr> <td>< 8 φ</td> <td>1000</td> </tr> <tr> <td>8 φ 10 φ</td> <td>2000</td> </tr> <tr> <td>≥ 13 φ</td> <td>3000</td> </tr> </tbody> </table>	D φ	Life hours	< 8 φ	1000	8 φ 10 φ	2000	≥ 13 φ
D φ	Life hours								
< 8 φ	1000								
8 φ 10 φ	2000								
≥ 13 φ	3000								
Shelf Life	Test conditions								
	Duration time : 1000Hrs Ambient temperature : +125°C Applied voltage : None After test requirement at +20°C: Same limits as Endurance. Pre-treatment for measurements shall be conducted after application of DC working voltage for 30 minutes.								

Radial

Multiplier for Ripple Current vs. Frequency

CAP(µF)\Frequency(Hz)	50(60)	120	400	1K	10K	50K~100K
CAP ≤ 10	0.8	1	1.30	1.45	1.65	1.70
10 < CAP ≤ 100	0.8	1	1.23	1.36	1.48	1.53
100 < CAP ≤ 1000	0.8	1	1.16	1.25	1.35	1.38
1000 < CAP	0.8	1	1.11	1.17	1.25	1.28

Diagram of Dimensions:(unit:mm)

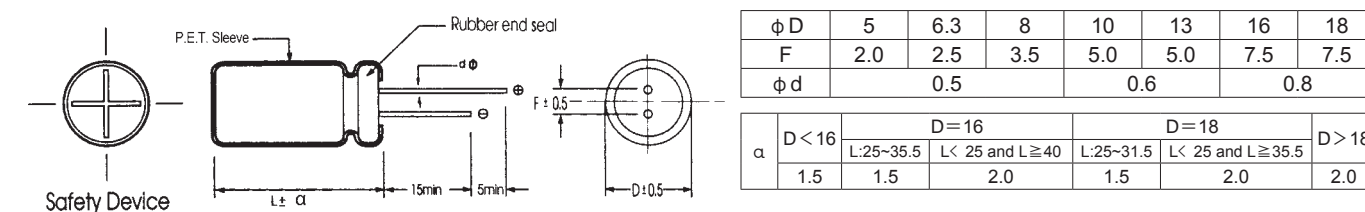

Case Size

WV (Vdc)	Cap (uF)	Size (mm)	Rated Ripple current (mAmps/125°C /120Hz)
10	47	5x11	92
10	56	5x11	100
10	100	5x11	130
10	100	6.3x11	145
10	120	6.3x11	160
10	330	8x11.5	350
10	330	10x12.5	410
10	470	8x11.5	430
10	470	8x16	500
10	470	10x12.5	505
10	470	10x16	525
10	560	10x12.5	530
10	680	8x20	640
10	680	10x16	660
10	1000	10x16	870
10	1000	10x20	960
10	1200	10x20	1000
10	1500	10x20	1120
16	22	5x11	66
16	33	6.3x11	91
16	47	5x11	97
16	47	6.3x11	110
16	100	6.3x11	175
16	100	8x11.5	206
16	220	8x11.5	340
16	220	10x12.5	400
16	330	8x11.5	400
16	330	8x16	460
16	330	10x12.5	470
16	330	10x16	525
16	470	8x11.5	500
16	470	8x20	640
16	470	10x12.5	590
16	470	10x16	650
16	470	10x20	720
16	680	10x20	760
16	820	10x16	740
16	820	10x25	900
16	1000	10x20	860
16	1000	10x25	950
16	1000	13x20	1000
25	22	6.3x11	70
25	33	5x11	88
25	33	6.3x11	100
25	47	5x11	97
25	47	6.3x11	110
25	47	8x11.5	130
25	56	6.3x11	120
25	100	8x11.5	210
25	100	10x12.5	250
25	120	8x11.5	220
25	150	8x11.5	260
25	180	8x11.5	290
25	220	8x11.5	360
25	220	8x16	415
25	220	10x12.5	420
25	220	10x16	470
25	270	8x20	470
25	270	10x12.5	435
25	330	8x16	510

WV (Vdc)	Cap (uF)	Size (mm)	Rated Ripple current (mAmps/125°C /120Hz)
25	330	10x12.5	520
25	330	10x16	570
25	330	10x20	631
25	390	10x16	650
25	470	8x20	620
25	470	10x16	640
25	470	10x20	700
25	470	10x25	770
25	470	13x20	810
25	560	10x20	680
25	560	10x25	750
25	680	10x20	740
25	1000	13x20	880
25	1000	13x25	970
25	1000	16x25	1100
25	1200	10x20	1010
25	1500	10x25	1220
25	1800	13x20	1350
25	2700	13x25	1710
25	3300	13x30	2070
25	5600	18x25	2730
25	6800	16x35.5	3300
25	8200	16x40	3750
35	22	5x11	72
35	22	6.3x11	82
35	33	8x11.5	108
35	47	6.3x11	110
35	47	8x11.5	130
35	47	10x12.5	158
35	56	6.3x11	130
35	100	8x11.5	200
35	100	10x12.5	230
35	100	10x16	262
35	120	8x11.5	300
35	120	8x16	350
35	150	10x12.5	360
35	180	8x20	410
35	180	10x12.5	380
35	220	10x12.5	440
35	220	10x16	490
35	220	10x20	540
35	270	10x16	500
35	270	10x20	550
35	330	10x16	560
35	330	10x25	680
35	330	13x20	718
35	390	10x20	590
35	470	10x20	700
35	470	13x20	810
35	470	13x25	900
35	560	10x20	580
35	560	13x16	610
35	680	10x20	800
35	820	10x25	980
35	1000	13x25	1140
35	1000	16x25	1280
35	1200	10x30	1290
35	1500	13x25	1368
35	2200	13x30	1660
35	2700	13x40	2350

WV (Vdc)	Cap (uF)	Size (mm)	Rated Ripple current (mArms/125°C /120Hz)
35	3300	16x31.5	2480
35	3300	18x25	2400
35	4700	16x40	3000
50	2.2	8x11.5	25
50	3.3	8x11.5	30
50	4.7	5x11	32
50	4.7	8x11.5	43
50	10	5x11	42
50	10	6.3x11	48
50	10	8x11.5	56
50	22	5x11	66
50	22	6.3x11	75
50	22	8x11.5	86
50	33	8x11.5	118
50	47	6.3x11	120
50	47	8x11.5	140
50	47	10x12.5	164
50	56	8x11.5	150
50	68	8x11.5	160
50	82	8x11.5	170
50	100	10x12.5	230
50	100	10x16	250
50	100	10x20	277
50	120	10x16	290
50	180	10x20	400
50	220	10x20	510
50	220	10x25	560
50	220	13x20	587
50	270	10x20	610
50	330	10x20	700
50	330	13x20	810
50	330	13x25	900
50	470	13x25	900
50	470	16x25	1000
50	560	10x30	950
50	680	13x25	1050
50	1000	13x30	1390
50	1200	13x35	1510
50	1200	18x20	1450
50	1500	13x40	1960
50	1800	18x25	1960
50	2200	18x31.5	2500
50	2700	18x35.5	2750
50	3300	18x40	2950
63	4.7	6.3x11	38
63	10	8x11.5	58
63	22	8x11.5	93
63	33	8x11.5	115
63	33	10x12.5	132
63	47	10x12.5	155
63	47	10x16	172
63	100	10x16	260
63	180	10x20	400
63	220	10x25	520
63	220	13x25	595
63	330	13x25	880
63	330	16x25	1000
63	390	13x20	800
63	680	13x30	1290
63	820	13x35	1420
63	820	18x21	1360
63	1200	18x25	1620

WV (Vdc)	Cap (uF)	Size (mm)	Rated Ripple current (mArms/125°C /120Hz)
63	1500	18x31.5	1980
63	1800	16x40	2260
63	2200	18x40	2680
80	22	8x11.5	120
80	33	10x12.5	170
80	47	10x12.5	200
80	100	10x20	370
80	330	13x25	870
80	390	16x20	900
80	560	13x35	1100
80	560	16x25	1060
80	560	18x21	1050
80	680	16x31.5	1300
100	0.47	6.3x11	14
100	1	6.3x11	24
100	2.2	6.3x11	31
100	3.3	6.3x11	36
100	4.7	6.3x11	38
100	4.7	8x11.5	48
100	10	8x11.5	60
100	10	10x12.5	70
100	22	8x11.5	76
100	22	10x12.5	90
100	22	10x16	100
100	33	10x12.5	130
100	33	10x16	140
100	33	10x20	158
100	47	10x16	150
100	47	10x25	175
100	47	13x20	185
100	100	13x25	320
100	100	16x25	350
100	330	13x35	890
100	330	16x25	860
100	330	18x21	850
100	390	13x40	1050
100	390	16x31.5	1050
100	560	18x31.5	1290
100	680	18x35.5	1480
100	820	18x40	1850
160	1	6.3x11	23
160	2.2	6.3x11	35
160	3.3	6.3x11	37
160	3.3	8x11.5	41
160	4.7	8x11.5	52
160	6.8	10x12.5	70
160	10	8x11.5	70
160	10	10x12.5	82
160	22	10x16	115
160	22	10x20	128
160	33	13x20	200
160	47	13x20	240
160	47	13x25	260
160	82	10x30	340
160	100	10x35	380
160	100	13x25	390
160	100	16x25	430
160	120	10x40	450
160	150	13x30	500
160	180	13x35	600
160	180	18x20	550
160	220	16x31.5	690

WV (Vdc)	Cap (uF)	Size (mm)	Rated Ripple current (mAmps/125°C /120Hz)
160	330	18x35.5	900
200	1	6.3x11	23
200	2.2	6.3x11	35
200	3.3	8x11.5	48
200	4.7	8x11.5	50
200	4.7	10x12.5	60
200	6.8	10x12.5	70
200	10	10x12.5	80
200	22	10x20	140
200	22	10x25	150
200	22	13x20	160
200	33	13x20	200
200	33	13x25	220
200	47	13x20	245
200	47	13x25	270
200	47	16x25	300
200	56	13x20	260
200	82	13x25	360
200	100	13x30	430
200	100	16x20	400
200	100	16x25	440
200	100	16x31.5	490
200	150	13x40	600
200	150	16x25	530
200	180	18x25	650
200	220	18x31.5	850
200	330	18x35.5	1100
250	1	6.3x11	23
250	2.2	6.3x11	35
250	2.2	8x11.5	40
250	3.3	8x11.5	50
250	3.3	10x12.5	53
250	4.7	10x12.5	60
250	4.7	10x16	68
250	6.8	10x16	75
250	10	10x16	83
250	22	13x20	160
250	22	13x25	170
250	33	13x25	220
250	33	16x25	240
250	39	10x30	230
250	47	10x35	280
250	47	16x25	300
250	47	16x31.5	330
250	56	10x40	300
250	68	13x30	330
250	82	13x35	380
250	82	18x20	350
250	100	13x40	490
250	120	18x25	460

WV (Vdc)	Cap (uF)	Size (mm)	Rated Ripple current (mAmps/125°C /120Hz)
250	220	18x35.5	850
350	1	8x11.5	26
350	2.2	8x11.5	40
350	2.2	10x12.5	47
350	3.3	10x12.5	55
350	3.3	10x16	60
350	4.7	10x16	68
350	4.7	10x20	75
350	5.6	10x20	78
350	6.8	13x20	85
350	10	10x25	105
350	10	13x20	110
350	22	13x25	180
350	22	16x25	200
350	27	10x30	180
350	33	10x35	220
350	33	16x25	230
350	33	16x31.5	260
350	47	13x30	280
350	47	16x31.5	320
350	47	16x35.5	340
350	56	13x35	330
350	56	16x25	320
350	56	18x20	310
350	68	13x40	390
400	1	10x12.5	30
400	2.2	10x16	50
400	3.3	10x16	60
400	4.7	10x16	70
400	4.7	10x20	80
400	5.6	10x20	85
400	6.8	13x20	90
400	10	13x20	110
400	22	13x25	180
400	27	13x25	190
400	33	16x20	220
400	33	16x25	240
400	47	16x25	290
400	47	16x31.5	320
450	1	10x12.5	30
450	2.2	10x16	50
450	3.3	10x16	60
450	4.7	10x20	75
450	5.6	13x20	85
450	6.8	13x20	94
450	10	13x25	130
450	22	16x25	210
450	33	16x31.5	290
450	47	18x31.5	370

TE Series High Temperature

Features

- ◆ The series has guaranteed operation life of 1000~3000 hours at 130°C.
- ◆ Applications: High reliability equipment, filtering circuit of switching power supply, and industrial control equipment.
- ◆ RoHS Compliant



Specifications

Item	Performance Characteristics	
Operating Temperature Range	-40 to +130°C	-25 to +130°C
Rated Voltage Range	10 to 400 VDC	450 VDC
Capacitance Range	2.2 to 4700 µF	1 to 100 µF
Capacitance Tolerance	±20%(120Hz,+20°C)	
Leakage Current (+20°C,max.)	10 to 100VDC	160 to 450VDC
	$I \leq 0.01CV$ or 3uA	$CV \leq 1000$ $I \leq 0.1CV+40(uA)$ $CV > 1000$ $I \leq 0.04CV+100(uA)$
Dissipation Factor (tan δ , at 20°C , 120Hz)	Working Voltage(VDC) 10 16 25 35 50 63 100 160 200 250 350 400 450	
	D. F.(%) max. 20 16 14 12 10 9 8 15 15 15 20 20 25	
Low Temperature Characteristics (at 120Hz)	For capacitance > 1000 uF, add 2% per another 1000uF.	
	Impedance ratio max	
	Working Voltage(VDC) 10 16 25 35 50 63 100 160 200 250 350 400 450	
Endurance	Z-25°C / Z+20°C	3 2 2 2 2 2 2 3 3 3 5 5 6
	Z-40°C / Z+20°C	6 4 3 3 3 3 3 6 6 6 6 6 -
Shelf Life	Test conditions	
	Duration time :1000Hrs Ambient temperature :+130°C Applied voltage :None After test requirement at +20°C:Same limits as Endurance. Pre-treatment for measurements shall be conducted after application of DC working voltage for 30 minutes.	

Radial

Multiplier for Ripple Current vs. Frequency

10~100V

CAP(µF)\Frequency(Hz)	50(60)	120	1K	10K	50K~100K
CAP < 10	0.35	0.42	0.60	0.80	1.00
10~33	0.45	0.55	0.75	0.90	1.00
47~330	0.6	0.7	0.85	0.95	1.00
470~1500	0.65	0.75	0.90	0.98	1.00
1500 < CAP	0.75	0.8	0.95	1.00	1.00

160~450V

CAP(µF)\Frequency(Hz)	120	400	1K	10K	50K~100K
CAP < 33	0.40	0.60	0.75	0.90	1.00
CAP ≥ 33	0.45	0.65	0.80	0.95	1.00

Diagram of Dimensions:(unit:mm)

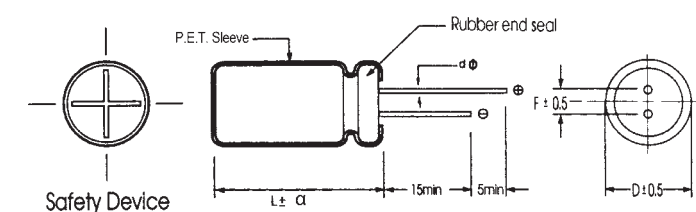

φ D	6.3	8	10	13	16	18
F	2.5	3.5	5.0	5.0	7.5	7.5
φ d	0.5		0.6		0.8	
α	D < 16		D = 16		D = 18	
	L:25~35.5		L < 25 and L ≥ 40		L:25~31.5 L < 25 and L ≥ 35.5	
	1.5	1.5	2.0	1.5	2.0	2.0

Case Size

WV (Vdc)	Cap (uF)	Size (mm)	Rated Ripple current (mArms/130°C /120Hz)	Rated Ripple current (mArms/130°C /100KHz)
10	220	8x11.5	252	360
10	330	8x11.5	333	475
10	330	10x12.5	350	500
10	470	10x12.5	503	670
10	470	10x16	540	720
10	1000	10x20	881	1175
10	1500	13x20	1121	1495
10	2200	13x25	1352	1690
10	3300	16x25	1820	2275
10	4700	16x31.5	2212	2765
16	220	8x11.5	252	360
16	220	10x12.5	263	375
16	330	8x11.5	277	395
16	330	10x16	361	515
16	470	10x12.5	491	655
16	470	10x20	600	800
16	1000	10x20	881	1175
16	1000	13x20	930	1240
16	1500	13x20	1136	1515
16	1500	13x25	1249	1665
16	2200	13x25	1352	1690
16	2200	16x25	1500	1875
16	3300	16x31.5	2152	2690
16	4700	16x35.5	2352	2940
25	220	8x11.5	252	360
25	220	10x16	333	475
25	330	10x12.5	441	630
25	330	10x20	543	775
25	470	10x16	566	755
25	470	13x20	720	960
25	1000	13x20	930	1240
25	1000	16x25	1099	1465
25	1500	16x25	1399	1865
25	1500	16x31.5	1549	2065
25	2200	16x31.5	1904	2380
25	2200	16x35.5	2012	2515
25	3300	16x35.5	2156	2695
25	3300	18x35.5	2300	2875
35	100	8x11.5	322	460
35	100	10x16	420	600
35	220	10x12.5	427	610
35	220	10x20	522	745
35	330	10x16	553	790
35	330	13x20	700	1000
35	470	10x20	690	920
35	470	13x25	881	1175
35	1000	13x25	926	1235
35	1000	16x31.5	1151	1535
35	1500	16x31.5	1755	2340
35	1500	16x35.5	1849	2465
35	2200	16x35.5	2156	2695
35	2200	18x35.5	2300	2875
50	10	6.3x11	77	140
50	22	6.3x11	110	200
50	22	8x11.5	132	240
50	33	8x11.5	157	285
50	47	8x11.5	193	275
50	47	10x12.5	220	315

WV (Vdc)	Cap (uF)	Size (mm)	Rated Ripple current (mArms/130°C /120Hz)	Rated Ripple current (mArms/130°C /100KHz)
50	100	10x12.5	325	465
50	100	10x16	360	515
50	220	10x20	606	865
50	220	13x20	700	1000
50	330	13x20	746	1065
50	330	13x25	823	1175
50	470	16x20	930	1240
50	470	16x25	1001	1335
50	1000	16x31.5	1849	2465
50	2200	18x40	2452	3065
63	33	8x11.5	140	255
63	47	10x12.5	200	285
63	100	10x16	290	415
63	220	13x20	592	845
63	330	13x25	802	1145
63	470	16x25	1091	1455
63	1000	16x31.5	1399	1865
63	1500	18x40	2051	2735
100	4.7	8x11.5	48	115
100	10	8x11.5	72	130
100	22	8x11.5	105	190
100	33	10x12.5	151	275
100	47	10x16	200	285
100	100	13x20	382	545
100	220	16x25	700	1000
100	330	16x31.5	942	1345
100	470	18x31.5	1200	1600
160	3.3	6.3x11	26	65
160	4.7	6.3x11	28	70
160	4.7	8x11.5	34	85
160	5.6	8x11.5	40	100
160	6.8	8x11.5	44	110
160	6.8	8x16	52	130
160	10	8x16	58	145
160	15	8x16	76	190
160	22	10x16	124	310
160	33	10x20	162	360
160	47	13x20	207	460
160	68	13x25	263	585
160	100	16x25	369	820
160	150	16x31.5	423	940
200	3.3	6.3x11	28	70
200	4.7	6.3x11	30	75
200	4.7	8x11.5	34	85
200	5.6	8x11.5	40	100
200	5.6	8x16	48	120
200	6.8	8x11.5	46	115
200	6.8	8x16	54	135
200	10	8x16	64	160
200	10	8x20	72	180
200	15	8x16	76	190
200	15	8x20	84	210
200	22	8x20	124	310
200	22	10x16	124	310
200	22	10x20	128	320
200	33	10x20	162	360
200	33	13x20	184	410
200	47	13x20	207	460

WV (Vdc)	Cap (uF)	Size (mm)	Rated Ripple current (mAmps/130°C /120Hz)	Rated Ripple current (mAmps/130°C /100KHz)
200	47	13x25	232	515
200	68	16x20	263	585
200	68	16x25	284	630
200	100	13x30	304	675
200	100	16x25	369	820
200	150	13x40	396	880
200	150	16x35.5	425	945
250	3.3	6.3x11	30	75
250	4.7	8x11.5	44	110
250	5.6	8x11.5	44	110
250	6.8	8x16	54	135
250	8.2	8x16	66	165
250	10	8x16	72	180
250	15	8x20	88	220
250	22	10x16	120	300
250	33	13x20	203	450
250	47	13x20	214	475
250	68	13x30	288	640
250	68	16x25	288	640
250	100	13x35	320	710
250	100	16x31.5	376	835
250	150	13x50	441	980
250	150	16x35.5	461	1025
350	2.2	6.3x11	24	60
350	3.3	8x11.5	34	85
350	4.7	8x11.5	44	110
350	5.6	8x16	50	125
350	6.8	8x20	60	150
350	8.2	8x20	68	170
350	10	10x20	78	195
350	15	10x20	100	250
350	22	13x20	124	310
350	33	16x20	203	450
350	47	16x20	243	540
350	68	18x25	290	645
350	100	18x31.5	383	850
400	2.2	6.3x11	30	75
400	2.2	8x11.5	34	85
400	2.2	8x16	38	95
400	2.7	8x16	40	100
400	3.3	8x11.5	38	95
400	3.3	8x16	46	115
400	3.3	8x20	50	125

WV (Vdc)	Cap (uF)	Size (mm)	Rated Ripple current (mAmps/130°C /120Hz)	Rated Ripple current (mAmps/130°C /100KHz)
400	4.7	8x11.5	44	110
400	4.7	8x20	50	125
400	4.7	10x16	50	125
400	5.6	8x20	54	135
400	5.6	10x16	54	135
400	5.6	10x20	60	150
400	6.8	8x20	60	150
400	6.8	10x16	60	150
400	6.8	10x20	66	165
400	8.2	10x16	68	170
400	8.2	10x20	76	190
400	10	10x16	76	190
400	10	10x20	80	200
400	10	10x25	86	215
400	15	13x20	104	260
400	22	13x25	138	345
400	33	16x25	207	460
400	47	13x40	234	520
400	47	16x31.5	275	610
400	47	18x25	261	579
400	68	13x55	335	745
400	68	18x31.5	297	660
400	100	18x40	396	880
450	1	8x11.5	26	65
450	2.2	8x16	38	95
450	3.3	8x16	40	100
450	4.7	8x20	50	125
450	5.6	10x16	54	135
450	6.8	10x20	66	165
450	8.2	10x20	76	190
450	10	10x25	86	215
450	10	13x20	86	215
450	15	13x20	104	260
450	22	10x40	140	350
450	22	16x20	138	345
450	22	16x25	154	385
450	33	10x50	203	450
450	33	16x25	218	485
450	33	16x31.5	245	545
450	47	13x45	254	565
450	47	16x35.5	270	600
450	68	18x31.5	297	660
450	100	18x40	396	880

KS Series 105°C Overvoltage Vent Operation Facility



Features

- ◆ High ripple current capability
- ◆ This series has specification of vent operation in overvoltage situation
- ◆ RoHS Compliant

Specifications

Item	Performance Characteristics		
Operating Temperature Range	-25~+105°C		
Rated Voltage Range	200V · 400V		
capacitance range	4.7~470µF		
Capacitance Tolerance	±20%(120Hz,+20°C)		
Leakage Current (+20°C,max.)	I ≤ 0.03 CV (µA) After 1 minute with rated working voltage applied.		
Dissipation Factor (tan δ , at 20°C , 120Hz)	Rated Voltage(VDC)	200	400
	D.F. (%)max.	15	15
Endurance	Test condition		
	Duration time	:2000Hrs	
	Ambient temperature	:+105°C	
	Applied voltage	:Rated DC working voltage	
	After test requirement at +20°C		
	Capacitance change	: ≤ ±20% of the initial measured value	
	Dissipation factor	: ≤ 200% of the initial specified value	
Leakage current	: ≤ The initial specified value		
Shelf Life	Test condition		
	Duration time	:1000Hrs	
	Ambient temperature	:+105°C	
	Applied voltage	:None	
	After test requirement at +20°C	:Same limits as Endurance.	
	Pre-treatment for measurements shall be conducted after application of DC working voltage for 30 minutes.		

Multiplier for Ripple Current vs. Frequency

VDC	Capacitance(µF)	Frequency(Hz)					
		60(50)	120	400	1K	1K	≥10K
200	22~470	0.85	1	1.1	1.25	1.25	1.5
	4.7~68	0.85	1	1.05	1.2	1.2	1.4
400	82~150	0.85	1	1.03	1.15	1.15	1.35

Diagram of Dimensions:(unit:mm)

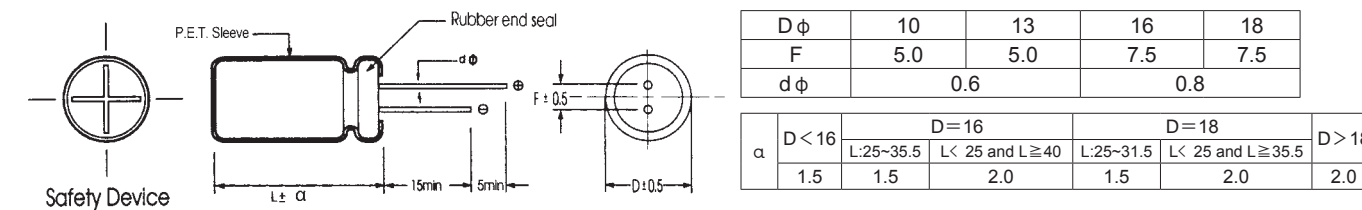

Case Size

WV (Vdc)	Cap (uF)	Size (mm)	Rated Ripple current (mAmps/105°C /120Hz)
200	22	10x20	120
200	33	10x25	160
200	33	13x20	160
200	47	10x30	195
200	47	13x20	195
200	56	13x25	210
200	68	13x25	270
200	68	16x20	270
200	82	13x30	310
200	82	16x20	320
200	82	16x25	360
200	100	16x25	400
200	100	18x20	400
200	120	16x25	460
200	120	16x31.5	500
200	120	18x25	500
200	150	16x31.5	560
200	150	16x35.5	590
200	150	18x25	560
200	180	16x35.5	600
200	180	18x31.5	650
200	220	18x31.5	700
200	220	18x35.5	740
200	330	18x35.5	780
200	330	18x40	840
200	390	18x40	860
200	390	18x45	920
200	470	18x45	1120

WV (Vdc)	Cap (uF)	Size (mm)	Rated Ripple current (mAmps/105°C /120Hz)
400	4.7	10x12.5	60
400	10	10x16	100
400	10	10x20	125
400	22	13x20	135
400	22	13x25	150
400	22	16x20	150
400	33	13x25	180
400	33	16x20	210
400	47	16x31.5	300
400	47	16x35.5	320
400	47	18x25	300
400	47	18x31.5	320
400	56	16x31.5	360
400	56	18x25	350
400	56	18x31.5	370
400	68	16x31.5	365
400	68	16x35.5	380
400	68	18x31.5	375
400	82	16x35.5	410
400	82	18x31.5	410
400	82	18x35.5	450
400	100	16x35.5	470
400	100	18x31.5	470
400	100	18x35.5	490
400	120	18x31.5	520
400	120	18x35.5	540
400	120	18x40	560
400	150	18x35.5	770
400	150	18x40	790

FK Series Long Life for 105°C

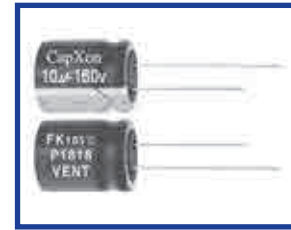

Features

- ◆ Specially designed for electronic ballast, energy-save lamp and LED driving power
- ◆ Endurance 6000~8000 hrs at 105°C
- ◆ Safety vent construction design.
- ◆ RoHS Compliant

Specifications

Item	Performance Characteristics															
Operating Temperature Range	-40 to +105°C(160~450Vdc) -25 to +105°C(500Vdc)															
Rated Voltage Range	160 to 500 VDC															
Capacitance Range	1 to 330 µF															
Capacitance Tolerance	±20%(120Hz,+20°C)															
Leakage Current (+20°C,max.)	(CV ≤ 1000)	(CV > 1000)														
	1 ≤ 0.1CV+40(µA)	1 ≤ 0.04CV+100(µA)														
After 1minute with rated working voltage applied. C: rated Capacitance (µF) · V: working voltage(V)																
Dissipation Factor (tan δ, at 20°C, 120Hz)	Working Voltage(VDC)	160 200 250 350 400 420 450 500														
	D.F.(%)max.	15 15 15 20 20 20 20 24														
Low Temperature Characteristics (at 120Hz)	Impedance ratio max															
	Working Voltage(VDC)	160	200	250	350	400	420	450	500							
	Z-25°C / Z+20°C	3	3	3	5	5	6	6	6							
	Z-40°C / Z+20°C	6	6	6	6	6	-	-	-							
Endurance	Test condition		Duration time		Ambient temperature		Applied voltage		After test requirement at +20°C		Capacitance change		Dissipation factor		Leakage current	
	:As right		:1000Hrs		:+105°C		:Rated DC working voltage		:with ±20% of the initial measured value		:≤ 200% of the initial specified value		:≤ The initial specified value			
	D φ		Life (hours)		6.3 φ, 8 φ, 10 φ x9L		6000		10 φ x12.5L or more		8000					
Shelf Life	Test condition		Duration time		Ambient temperature		Applied voltage		After test requirement at +20°C		Pre-treatment for measurements shall be conducted after application of DC working voltage for 30 minutes.					
	:None		:1000Hrs		:+105°C		:None		:Same limits as Endurance.							

Multiplier for Ripple Current vs. Frequency

Frequency(Hz) \ CAP(µF)	120	1K	10K	100KHz
1~82	1.00	1.75	2.25	2.50
≥ 100	1.00	1.67	2.05	2.25

Diagram of Dimensions:(unit:mm)

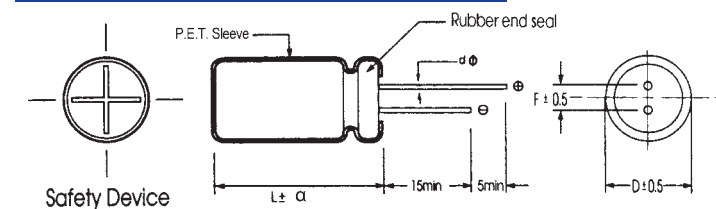

φ D	8	10	13	16	18	22
F	3.5		5.0	5.0	7.5	7.5
φ d	L < 20	L ≥ 20		0.6		0.8
	0.5		0.6			
α	D=16		D=18		D > 18	
	D < 16	L:25~35.5	L < 25 and L ≥ 40	L:25~31.5	L < 25 and L ≥ 35.5	D > 18
	1.5	1.5	2.0	1.5	2.0	2.0

Case Size

WV (Vdc)	Cap (uF)	Size (mm)	Rated Ripple current (mArms/105°C /120Hz)	Rated Ripple current (mArms/105°C /100KHz)
160	1	6.3x11	20	51
160	1	6.3x9	18	46
160	1.5	6.3x11	22	56
160	1.5	6.3x9	20	51
160	2.2	6.3x11	28	71
160	2.2	6.3x9	26	65
160	3.3	6.3x11	32	81
160	3.3	6.3x9	29	73
160	4.7	6.3x11	36	91
160	4.7	6.3x9	34	86
160	5.6	6.3x11	38	96
160	5.6	6.3x9	36	91
160	5.6	8x11.5	44	110
160	6.8	6.3x11	44	110
160	6.8	8x11.5	52	130
160	6.8	8x9	44	110
160	8.2	8x11.5	60	150
160	8.2	8x9	56	140
160	10	8x11.5	96	240
160	10	8x16	110	280
160	10	8x9	88	220
160	10	10x12.5	120	290
160	15	8x16	110	280
160	15	10x9	100	260
160	22	8x20	180	450
160	22	10x12.5	160	410
160	22	10x16	180	460
160	33	10x16	230	570
160	33	10x20	250	630
160	47	10x16	300	740
160	47	10x20	300	760
160	68	13x20	470	1180
160	82	13x20	520	1290
160	100	13x25	620	1400
160	100	16x20	630	1420
160	150	16x25	840	1880
160	220	18x25	1090	2460
160	270	16x31.5	1260	2830
160	330	18x31.5	1400	3140
200	1	6.3x11	23	57
200	1	6.3x9	21	53
200	1.5	6.3x11	24	61
200	1.5	6.3x9	23	57
200	2.2	6.3x11	30	75
200	2.2	6.3x9	28	69
200	3.3	6.3x11	39	97
200	3.3	6.3x9	35	87
200	4.7	6.3x11	52	130
200	4.7	8x9	52	130
200	5.6	6.3x11	56	140
200	5.6	8x11.5	64	160
200	5.6	8x9	56	140
200	6.8	8x11.5	76	190
200	6.8	8x9	64	160
200	8.2	8x11.5	84	210
200	10	8x11.5	110	270
200	10	8x16	120	310
200	10	10x12.5	130	320

WV (Vdc)	Cap (uF)	Size (mm)	Rated Ripple current (mArms/105°C /120Hz)	Rated Ripple current (mArms/105°C /100KHz)
200	10	10x9	110	270
200	22	8x20	220	550
200	22	10x16	220	560
200	22	10x20	250	620
200	33	10x16	260	650
200	33	10x20	280	710
200	47	13x16	360	890
200	47	13x20	390	980
200	68	13x20	470	1180
200	68	13x25	520	1300
200	100	13x25	630	1420
200	100	16x25	680	1530
200	150	18x25	900	2020
200	220	16x31.5	1090	2460
250	1	6.3x11	24	59
250	1	6.3x9	21	53
250	1.5	6.3x11	24	61
250	1.5	6.3x9	23	57
250	2.2	6.3x11	30	76
250	2.2	6.3x9	28	69
250	2.2	8x11.5	38	95
250	3.3	6.3x11	40	100
250	3.3	6.3x9	35	87
250	3.3	8x11.5	56	140
250	4.7	8x11.5	64	160
250	4.7	8x16	72	180
250	4.7	8x9	52	130
250	4.7	10x12.5	76	190
250	5.6	8x11.5	72	180
250	5.6	8x9	64	160
250	6.8	8x11.5	80	200
250	6.8	8x16	92	230
250	6.8	10x12.5	100	250
250	8.2	8x16	88	220
250	8.2	10x9	80	200
250	10	8x16	120	290
250	10	10x12.5	120	300
250	15	10x16	130	330
250	22	10x16	180	460
250	22	10x20	200	510
250	33	10x20	270	680
250	33	13x16	270	680
250	33	13x20	320	800
250	47	13x20	400	990
250	47	13x25	430	1080
250	56	13x25	500	1260
250	68	16x25	560	1400
250	100	16x25	680	1540
250	150	16x31.5	900	2020
250	220	18x31.5	1130	2550
350	1	6.3x11	26	66
350	1	6.3x9	21	53
350	1	8x11.5	31	77
350	1.5	6.3x11	30	75
350	1.5	6.3x9	26	66
350	2.2	6.3x11	38	95
350	2.2	8x11.5	48	120
350	2.2	8x9	35	88

WV (Vdc)	Cap (uF)	Size (mm)	Rated Ripple current (mAmps/105°C /120Hz)	Rated Ripple current (mAmps/105°C /100KHz)
350	3.3	8x11.5	56	140
350	3.3	8x9	48	120
350	3.3	10x12.5	64	160
350	4.7	8x16	72	180
350	4.7	10x12.5	76	190
350	4.7	10x9	64	160
350	5.6	8x16	84	210
350	5.6	10x12.5	88	220
350	6.8	8x20	110	270
350	6.8	10x16	110	280
350	8.2	8x20	130	320
350	10	8x20	130	320
350	10	10x16	130	330
350	15	10x20	150	370
350	22	13x20	260	650
350	33	13x25	380	940
350	47	16x20	430	1080
350	47	16x25	460	1160
350	68	18x20	560	1400
350	68	18x25	600	1510
350	82	18x25	610	1530
350	100	16x31.5	720	1630
350	150	18x35.5	960	2170
400	1	6.3x11	30	76
400	1	6.3x9	25	63
400	1.5	6.3x9	30	76
400	1.5	8x11.5	36	91
400	2.2	6.3x11	44	110
400	2.2	8x11.5	48	120
400	2.2	8x9	40	100
400	3.3	8x11.5	60	150
400	3.3	8x9	52	130
400	4.7	8x11.5	80	200
400	4.7	8x16	88	220
400	4.7	10x12.5	92	230
400	4.7	10x9	72	180
400	5.6	8x16	88	220
400	5.6	10x12.5	100	250
400	6.8	8x16	110	270
400	6.8	10x12.5	110	280
400	8.2	8x16	110	280
400	8.2	10x12.5	120	290
400	8.2	10x16	130	320
400	10	8x20	140	350
400	10	10x16	140	360
400	10	10x20	160	400
400	15	10x20	190	480
400	15	13x16	200	500
400	22	13x20	260	650
400	33	13x25	360	900
400	33	16x20	360	900

WV (Vdc)	Cap (uF)	Size (mm)	Rated Ripple current (mAmps/105°C /120Hz)	Rated Ripple current (mAmps/105°C /100KHz)
400	47	16x25	470	1180
400	56	18x25	560	1400
400	68	18x25	590	1480
400	82	16x31.5	630	1580
400	100	18x31.5	770	1730
400	120	18x31.5	830	1860
400	150	18x35.5	930	2090
450	1	6.3x11	30	76
450	1	6.3x9	25	63
450	1.5	8x11.5	36	91
450	2.2	8x11.5	48	120
450	2.2	8x16	56	140
450	2.2	8x9	40	100
450	2.2	10x12.5	60	150
450	3.3	8x11.5	64	160
450	3.3	10x12.5	80	200
450	3.3	10x9	68	170
450	4.7	8x16	100	250
450	4.7	10x12.5	100	250
450	4.7	10x16	110	270
450	5.6	10x16	110	280
450	6.8	8x20	120	300
450	6.8	10x16	130	320
450	6.8	10x20	140	340
450	8.2	10x20	140	360
450	10	10x20	160	390
450	15	13x20	220	550
450	22	13x25	290	730
450	22	16x20	290	730
450	33	13x25	360	900
450	33	16x25	390	980
450	47	16x25	470	1180
450	47	18x25	500	1260
450	68	16x31.5	630	1580
450	68	18x25	590	1480
450	82	18x31.5	680	1700
450	100	18x35.5	800	1790
500	4.7	10x20	88	220
500	5.6	10x20	92	230
500	6.8	10x20	130	320
500	8.2	10x20	130	320
500	10	13x20	140	360
500	15	13x25	180	450
500	22	16x25	230	580
500	33	18x25	390	980
500	47	16x31.5	500	1260
500	56	18x31.5	570	1420
500	68	18x35.5	630	1580
500	82	18x40	680	1700
500	100	18x45	800	1800
500	120	22x45	840	1900

FL Series Long Life 105°C

Features

- ◆ Specially designed for electronic ballast 、 energy-save lamp and LED driving power
- ◆ Endurance 8000~12000 hrs at 105°C
- ◆ Safety vent construction design.
- ◆ RoHS Compliant

FK **long life** → FL



Specifications

Item	Performance Characteristics									
Operating Temperature Range	-40 to +105°C(160~450Vdc)	-25 to +105°C(500Vdc)								
Rated Voltage Range	160 to 500 VDC									
Capacitance Range	1.0 to 680 µ F									
Capacitance Tolerance	±20%(120Hz,+20°C)									
Leakage Current (+20°C,max.)	(CV ≤ 1000)	(CV > 1000)								
	1 ≤ 0.1CV+40(µ A)	1 ≤ 0.04CV+100(µ A)								
After 1minute with rated working voltage applied. C: rated Capacitance (µ F) · V: working voltage(V)										
Dissipation Factor (tan δ , at 20°C , 120Hz)	Working Voltage(VDC)	160 200 250 350 400 420 450 500								
	D.F.(%)max.	15 15 15 20 20 20 20 24								
Low Temperature Characteristics (at 120Hz)	Impedance ratio max									
	Working Voltage(VDC)	160	200	250	350	400	420	450	500	
	Z-25°C / Z+20°C	3	3	3	5	5	6	6	6	
	Z-40°C / Z+20°C	6	6	6	6	6	-	-	-	
Endurance	Test condition	:As right							D φ	Life (hours)
	Duration time	:+105°C							6.3 φ , 8 φ	8000
	Ambient temperature	:Rated DC working voltage							10 φ	10000
	Applied voltage	: with ±20% of the initial measured value							≥ 13 φ	12000
	After test requirement at +20°C	: ≤ 200% of the initial specified value								(500V:10000)
	Capacitance change	: ≤ The initial specified value								
	Dissipation factor									
	Leakage current									
Shelf Life	Test condition	:1000Hrs								
	Duration time	:+105°C								
	Ambient temperature	:None								
	Applied voltage									
After test requirement at +20°C:Same limits as Endurance. Pre-treatment for measurements shall be conducted after application of DC working voltage for 30 minutes.										

Radial

Multiplier for Ripple Current vs. Frequency

Frequency(Hz) \ CAP(µ F)	120	1K	10K	100KHz
1~82	1.00	1.75	2.25	2.50
≥ 100	1.00	1.67	2.05	2.25

Diagram of Dimensions:(unit:mm)

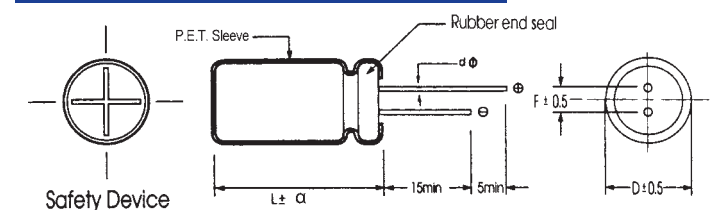

φ D	8	10	13	16	18	20	22
F	3.5	5.0	5.0	7.5	7.5	10	10
φ d	L < 20	L ≥ 20	0.6	0.8			
	0.5	0.6					
α	D < 16	D = 16		D = 18		D > 18	
	L: 25~35.5	L < 25 and L ≥ 40	L: 25~31.5	L < 25 and L ≥ 35.5	2.0		
	1.5	1.5	2.0	1.5	2.0	2.0	

Case Size

WV (Vdc)	Cap (uF)	Size (mm)	Rated Ripple current (mArms/105°C /120Hz)	Rated Ripple current (mArms/105°C /100KHz)
160	1	6.3x11	18	46
160	1.5	6.3x11	20	51
160	2.2	6.3x11	25	62
160	3.3	6.3x11	37	93
160	4.7	8x11.5	38	95
160	5.6	8x11.5	40	100
160	6.8	8x11.5	50	125
160	6.8	8x16	59	148
160	10	8x11.5	72	180
160	15	8x16	100	250
160	15	10x12.5	100	260
160	22	10x16	140	350
160	22	10x20	150	380
160	33	10x16	190	480
160	33	10x20	210	520
160	39	10x16	240	600
160	47	10x20	300	760
160	56	10x20	310	770
160	68	13x20	480	1190
160	68	13x25	520	1310
160	82	10x25	440	1100
160	82	13x20	510	1280
160	100	13x20	590	1330
160	100	13x25	630	1420
160	100	16x20	630	1420
160	150	13x25	730	1650
160	150	16x20	770	1740
160	150	16x25	820	1850
160	180	16x20	870	1950
160	220	16x25	1020	2300
160	220	18x20	1000	2250
160	220	18x25	1040	2350
160	330	16x31.5	1350	3040
160	330	18x31.5	1380	3100
160	390	16x35.5	1510	3400
160	470	16x40	1710	3850
160	470	18x35.5	1720	3860
160	560	18x40	1910	4290
160	680	18x45	2130	4800
200	1	6.3x11	26	65
200	1.5	6.3x11	28	70
200	2.2	6.3x11	34	85
200	3.3	6.3x11	46	115
200	4.7	8x11.5	64	160
200	5.6	8x11.5	66	166
200	6.8	8x11.5	70	175
200	6.8	10x12.5	76	190
200	10	8x16	92	230
200	10	10x16	100	260
200	12	10x12.5	100	260
200	15	8x20	140	350
200	22	10x16	180	450
200	22	10x20	200	500
200	27	10x16	200	510
200	33	10x20	260	660
200	33	13x20	300	750
200	47	10x20	310	770
200	47	13x20	400	990

WV (Vdc)	Cap (uF)	Size (mm)	Rated Ripple current (mArms/105°C /120Hz)	Rated Ripple current (mArms/105°C /100KHz)
200	56	10x25	380	950
200	68	13x20	470	1180
200	68	13x25	520	1300
200	68	16x20	520	1300
200	82	16x20	560	1400
200	100	13x25	640	1450
200	100	16x20	670	1500
200	100	16x25	690	1550
200	100	18x20	710	1600
200	120	16x20	720	1620
200	150	16x20	790	1780
200	150	16x25	840	1900
200	150	18x25	890	2000
200	180	16x25	910	2050
200	180	18x20	910	2050
200	220	18x25	1050	2370
200	220	18x31.5	1160	2600
200	270	16x35.5	1250	2820
200	330	16x40	1430	3210
200	330	18x31.5	1400	3140
200	330	18x35.5	1440	3230
200	390	18x35.5	1520	3420
200	470	18x40	1750	3930
200	470	18x45	1820	4100
220	27	10x16	200	510
220	39	10x20	270	670
220	68	13x20	480	1190
220	150	16x25	850	1910
220	220	16x31.5	1110	2500
220	270	18x31.5	1260	2840
220	330	16x45	1450	3270
220	390	18x45	1620	3650
220	470	18x50	1840	4150
250	1	6.3x11	26	65
250	1.5	6.3x11	28	70
250	2.2	6.3x11	34	85
250	3.3	6.3x11	46	115
250	3.3	8x11.5	60	150
250	4.7	8x11.5	68	170
250	5.6	8x11.5	76	190
250	6.8	8x16	96	240
250	6.8	10x12.5	96	240
250	8.2	8x20	120	290
250	10	8x16	120	300
250	10	10x16	130	330
250	15	8x20	150	380
250	22	10x16	200	490
250	22	10x20	220	540
250	22	13x20	250	620
250	33	10x20	270	680
250	33	13x16	270	680
250	33	13x20	320	800
250	47	13x20	400	990
250	47	13x25	410	1020
250	47	16x20	450	1120
250	56	13x20	430	1070
250	68	13x25	500	1240
250	68	16x20	530	1320

WV (Vdc)	Cap (uF)	Size (mm)	Rated Ripple current (mAmps/105°C /120Hz)	Rated Ripple current (mAmps/105°C /100KHz)
250	68	16x25	570	1420
250	68	18x20	570	1420
250	82	13x25	570	1420
250	82	16x20	580	1450
250	100	16x25	760	1700
250	100	16x31.5	800	1800
250	100	18x20	720	1630
250	100	18x25	780	1750
250	120	16x25	780	1750
250	120	18x20	780	1750
250	150	18x25	890	2000
250	150	18x31.5	980	2200
250	180	16x31.5	1020	2300
250	180	18x25	980	2200
250	220	16x35.5	1130	2550
250	220	18x31.5	1130	2550
250	270	16x40	1290	2900
250	270	18x35.5	1310	2950
250	330	18x40	1460	3290
350	1	8x11.5	30	75
350	1.5	8x11.5	32	80
350	2.2	10x12.5	44	110
350	3.3	10x12.5	60	150
350	4.7	10x16	80	200
350	6.8	10x16	100	260
350	10	10x20	130	330
350	15	10x20	160	400
350	18	10x20	180	450
350	22	10x20	200	500
350	22	13x20	260	650
350	27	10x25	260	650
350	33	13x20	330	830
350	33	13x25	360	900
350	33	16x20	380	940
350	47	13x25	430	1070
350	47	16x20	440	1100
350	47	18x20	470	1180
350	56	16x20	480	1200
350	68	16x25	570	1420
350	68	16x31.5	620	1550
350	68	18x20	570	1420
350	68	18x25	620	1550
350	82	16x25	620	1560
350	82	18x25	640	1600
350	100	16x31.5	800	1800
350	100	18x25	780	1750
350	120	16x35.5	860	1930
350	120	18x31.5	870	1950
350	150	16x40	1020	2300
350	150	18x35.5	1020	2300
350	180	18x40	1080	2440
400	1	8x9	26	65
400	1	8x11.5	30	75
400	1.5	8x9	30	76
400	1.5	8x11.5	36	91
400	1.5	8x16	40	101
400	2.2	8x11.5	40	100
400	2.2	8x16	56	140
400	3.3	8x11.5	52	130
400	3.3	8x16	60	150

WV (Vdc)	Cap (uF)	Size (mm)	Rated Ripple current (mAmps/105°C /120Hz)	Rated Ripple current (mAmps/105°C /100KHz)
400	3.3	8x20	61	153
400	3.3	10x12.5	60	151
400	3.3	10x16	73	182
400	3.9	8x16	66	165
400	4.7	8x11.5	72	180
400	4.7	8x20	92	230
400	4.7	10x16	96	240
400	5.6	8x20	100	250
400	5.6	10x16	100	250
400	5.6	10x20	110	280
400	6.8	8x20	120	290
400	6.8	10x16	120	300
400	8.2	10x16	120	300
400	8.2	10x20	130	320
400	10	10x16	130	330
400	10	10x20	140	350
400	15	10x20	180	460
400	15	13x20	200	500
400	22	13x20	280	690
400	22	13x25	310	770
400	22	16x20	320	790
400	27	13x20	300	750
400	33	13x25	330	820
400	33	16x20	340	840
400	39	13x25	390	980
400	47	16x25	480	1200
400	47	16x31.5	530	1320
400	47	18x20	470	1180
400	47	18x25	510	1270
400	56	16x25	500	1260
400	56	18x20	500	1250
400	68	16x25	580	1440
400	68	18x25	630	1570
400	68	18x31.5	700	1740
400	82	16x31.5	660	1660
400	82	18x25	650	1620
400	82	18x31.5	710	1770
400	100	16x35.5	760	1720
400	100	18x31.5	770	1740
400	120	16x40	870	1950
400	120	18x35.5	870	1960
400	150	18x40	1020	2300
400	180	18x45	1100	2480
420	6.8	10x16	120	300
420	12	10x20	150	380
420	15	10x25	190	470
420	22	13x20	290	720
420	27	13x25	340	850
420	33	16x20	390	970
420	47	16x25	500	1260
420	47	18x20	500	1260
420	68	16x31.5	650	1620
420	68	18x25	620	1550
420	82	16x35.5	730	1830
420	82	18x31.5	730	1830
420	100	16x40	830	1870
420	100	18x35.5	840	1890
420	120	18x40	930	2100
420	120	18x45	950	2130
420	150	18x50	1060	2390

WV (Vdc)	Cap (uF)	Size (mm)	Rated Ripple current (mAmps/105°C /120Hz)	Rated Ripple current (mAmps/105°C /100KHz)
450	1	8x9	26	65
450	1	8x11.5	33	83
450	1.5	8x11.5	37	92
450	1.5	10x9	37	93
450	1.8	8x11.5	39	97
450	1.8	10x9	39	98
450	2.2	8x16	56	141
450	3.3	8x16	61	153
450	4.7	10x16	92	230
450	5.6	10x16	100	260
450	6.8	10x16	130	320
450	6.8	10x20	140	350
450	8.2	10x20	140	350
450	10	10x20	140	360
450	10	10x25	160	400
450	10	13x16	150	380
450	15	10x25	190	470
450	15	13x20	200	500
450	18	13x20	260	640
450	22	13x25	290	720
450	22	16x20	300	750
450	22	18x20	320	790
450	27	13x25	340	850
450	33	16x20	390	970
450	33	16x25	420	1050
450	33	16x31.5	460	1160
450	33	18x20	420	1040
450	33	18x25	450	1120

WV (Vdc)	Cap (uF)	Size (mm)	Rated Ripple current (mAmps/105°C /120Hz)	Rated Ripple current (mAmps/105°C /100KHz)
450	39	18x20	440	1110
450	47	16x25	500	1260
450	47	16x31.5	560	1390
450	47	18x25	540	1340
450	47	18x31.5	590	1480
450	56	16x31.5	590	1470
450	56	18x25	560	1400
450	56	18x31.5	630	1570
450	68	16x35.5	660	1650
450	68	18x31.5	660	1660
450	82	16x40	750	1880
450	82	18x31.5	720	1790
450	82	18x35.5	750	1880
450	100	18x35.5	840	1890
450	100	18x40	900	2020
450	120	18x45	950	2130
450	150	18x50	1070	2400
500	10	13x20	130	330
500	12	13x20	140	350
500	15	13x25	180	450
500	15	16x20	180	450
500	22	16x25	230	570
500	22	18x20	220	560
500	33	16x31.5	290	720
500	33	18x25	280	700
500	47	18x31.5	360	890
500	56	18x35.5	390	970
500	68	18x40	420	1060

LE Series 105°C 12000~20000 hours

Features

- ◆ Ultra Long life
- ◆ For LED lighting
- ◆ ROHS compliant

FL **long life** → LE



Specifications

Item	Performance Characteristics																
Operating Temperature Range	-40~+105°C																
Rated Voltage Range	160~450 ≥VDC																
Capacitance Range	1 to 68 µF																
Capacitance Tolerance	±20%(120Hz, +20°C)																
Leakage Current (+20°C, max.)	<table border="1"> <tr> <td>(CV ≤ 1000)</td> <td>(CV > 1000)</td> <td rowspan="2">After 1 minute with rated working voltage applied. C: rated Capacitance (µF) · V: working voltage(V)</td> </tr> <tr> <td>1 ≤ 0.1CV+40(µA)</td> <td>1 ≤ 0.04CV+100(µA)</td> </tr> </table>	(CV ≤ 1000)	(CV > 1000)	After 1 minute with rated working voltage applied. C: rated Capacitance (µF) · V: working voltage(V)	1 ≤ 0.1CV+40(µA)	1 ≤ 0.04CV+100(µA)											
(CV ≤ 1000)	(CV > 1000)	After 1 minute with rated working voltage applied. C: rated Capacitance (µF) · V: working voltage(V)															
1 ≤ 0.1CV+40(µA)	1 ≤ 0.04CV+100(µA)																
Dissipation Factor (tan δ, at 20°C, 120Hz)	<p>Less than the value under table</p> <table border="1"> <tr> <td>Cap(µF) / W.v.(V)</td> <td>160~450</td> </tr> <tr> <td>tan δ</td> <td>24%</td> </tr> </table>	Cap(µF) / W.v.(V)	160~450	tan δ	24%												
Cap(µF) / W.v.(V)	160~450																
tan δ	24%																
Low Temperature Characteristics (at 120Hz)	<p>Impedance ratio max</p> <table border="1"> <tr> <td>Working voltage(V)</td> <td><250</td> <td>250~400</td> <td>450</td> </tr> <tr> <td>Z-25°C / Z+20°C</td> <td>3</td> <td>6</td> <td>8</td> </tr> <tr> <td>Z-40°C / Z+20°C</td> <td>8</td> <td>10</td> <td>12</td> </tr> </table>	Working voltage(V)	<250	250~400	450	Z-25°C / Z+20°C	3	6	8	Z-40°C / Z+20°C	8	10	12				
Working voltage(V)	<250	250~400	450														
Z-25°C / Z+20°C	3	6	8														
Z-40°C / Z+20°C	8	10	12														
Endurance	<table border="1"> <tr> <td>Test condition</td> <td></td> <td>6.3X11, 8X9, 10X9</td> <td>12000hours</td> </tr> <tr> <td>Duration time</td> <td>:As right</td> <td>8X11.5, 10X12.5</td> <td>15000hours</td> </tr> <tr> <td>Ambient temperature</td> <td>:+105°C</td> <td>10X16 or more</td> <td>20000hours</td> </tr> <tr> <td>Applied voltage</td> <td>:Rated DC working voltage</td> <td></td> <td></td> </tr> </table> <p>After test requirement at +20°C</p> <ul style="list-style-type: none"> Capacitance change : Within ±30% of the initial measured value Dissipation factor : Not more than 300% of the initial specified value Leakage current : Not more than The initial specified value 	Test condition		6.3X11, 8X9, 10X9	12000hours	Duration time	:As right	8X11.5, 10X12.5	15000hours	Ambient temperature	:+105°C	10X16 or more	20000hours	Applied voltage	:Rated DC working voltage		
Test condition		6.3X11, 8X9, 10X9	12000hours														
Duration time	:As right	8X11.5, 10X12.5	15000hours														
Ambient temperature	:+105°C	10X16 or more	20000hours														
Applied voltage	:Rated DC working voltage																
Shelf Life	<table border="1"> <tr> <td>Test condition</td> <td></td> <td>:1000 Hrs</td> </tr> <tr> <td>Duration time</td> <td></td> <td>:+105°C</td> </tr> <tr> <td>Ambient temperature</td> <td></td> <td>:None</td> </tr> <tr> <td>Applied voltage</td> <td></td> <td></td> </tr> </table> <p>After test requirement at +20°C: Same limits as Endurance. Pre-treatment for measurements shall be conducted after application of DC working voltage for 30 minutes.</p>	Test condition		:1000 Hrs	Duration time		:+105°C	Ambient temperature		:None	Applied voltage						
Test condition		:1000 Hrs															
Duration time		:+105°C															
Ambient temperature		:None															
Applied voltage																	

Radial

Multiplier for Ripple Current vs. Frequency

160~400V.DC

Coefficient	Frequency(Hz)			
	120	1K	10K	100K
1~5.6 µF	1.0	1.6	1.8	2.0
6.8~18 µF	1.0	1.5	1.7	1.9
22~33 µF	1.0	1.4	1.6	1.8

≥450V.DC

Coefficient	Frequency(Hz)			
	120	1K	10K	100K
4.7~15 µF	0.3	0.6	0.9	1.0
22~68 µF	0.4	0.7	0.9	1.0

Diagram of Dimensions:(unit:mm)

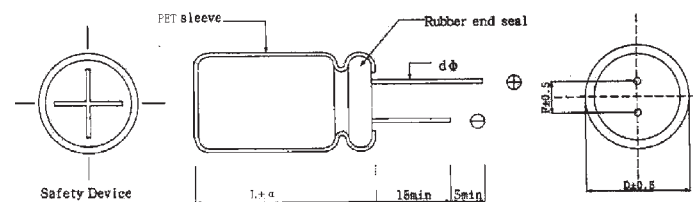

Dφ	6.3	8	10	13	16	18
F	2.5	3.5	5.0	5.0	7.5	7.5
dφ	0.5		0.6		0.8	

α	D=16		D=18		D>18	
	D<16	L:25~35.5	L<25 and L≥40	L:25~31.5		L<25 and L≥35.5
	1.5	1.5	2.0	1.5	2.0	2.0

Case Size

WV (Vdc)	Cap (uF)	Size (mm)	Rated Ripple current (mArms/105°C /120Hz)	Rated Ripple current (mArms/105°C /100KHz)
160	5.6	6.3x11	53	106
160	10	8x9	71	135
160	15	8x11.5	93	177
160	15	10x9	96	182
160	22	10x12.5	122	40
160	33	10x16	159	59
200	2.2	6.3x11	37	74
200	3.3	6.3x11	43	86
200	4.7	6.3x11	50	100
200	5.6	8x9	57	114
200	6.8	8x9	63	120
200	8.2	8x9	67	127
200	10	8x11.5	81	154
200	12	10x9	89	169
200	18	10x12.5	114	217
200	27	10x16	150	49
250	1.8	6.3x11	34	68
250	2.2	6.3x11	37	74
250	3.3	6.3x11	43	86
250	4.7	8x9	54	108
250	5.6	8x11.5	63	126
250	6.8	8x11.5	69	131
250	8.2	10x9	77	146
250	10	10x12.5	91	173
250	12	10x12.5	98	186

WV (Vdc)	Cap (uF)	Size (mm)	Rated Ripple current (mArms/105°C /120Hz)	Rated Ripple current (mArms/105°C /100KHz)
250	18	10x16	128	243
400	1	6.3x11	25	50
400	1.2	8x9	29	58
400	1.5	8x9	31	62
400	1.8	8x9	34	68
400	2.2	8x9	37	74
400	2.2	8x11.5	41	82
400	2.7	8x11.5	44	88
400	3.3	8x11.5	48	96
400	3.3	10x9	49	98
400	3.9	10x12.5	58	116
400	4.7	10x12.5	62	124
400	6.8	10x16	86	163
450	4.7	10x16	55	183
450	4.7	10x20	67	223
450	6.8	10x20	85	283
450	8.2	10x20	85	283
450	10	13x20	136	453
450	15	13x25	181	603
450	22	13x25	241	603
450	22	16x20	293	733
450	33	16x25	321	803
450	33	18x20	313	783
450	47	18x25	481	1203
450	68	18x31.5	521	1303

KY Series

Features

- ◆ Endurance: 105°C 2000hours
- ◆ Suitable for slim application

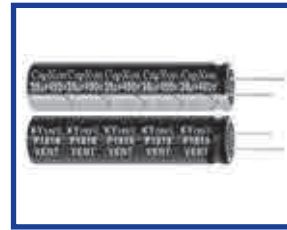

Specifications

Item	Performance Characteristics
Operating Temperature Range	-25~+105°C
Rated Voltage Range	250~450 VDC
Capacitance Range	12~150μF
Capacitance Tolerance	±20%(120Hz,+20°C)
Leakage Current (+20°C,max.)	$I \leq 3 \sqrt{CV}$ (μA) (After 5 minute with rated working voltage applied.) I= Leakage Current(μA) C= Rated Capacitance V= Rated voltage(V)
Dissipation Factor (tan δ , at 20°C , 120Hz)	Working Voltage(VDC) 250 350 400 420 450
	D.F.(%)max. 15 15 15 20 20
Low Temperature Characteristics (at 120Hz)	Impedance ratio max
	Working voltage(VDC) 250 350~450 Z-25°C / Z+20°C 3 8
Endurance	Test condition Duration time :2000Hrs Ambient temperature :+105°C Applied voltage :Rated DC working voltage After test requirement at +20°C Capacitance change :≤ ±20% of the initial measured value Dissipation factor :≤ 200% of the initial specified value Leakage current :≤ The initial specified value

Multiplier for Ripple Current vs. Frequency

Frequency(Hz)	60	120	400	1K	100K
Coefficient 250~350VV	0.8	1.00	1.20	1.30	1.40
Coefficient 400~450VV	0.8	1.00	1.25	1.40	1.50

Diagram of Dimensions:(unit:mm)

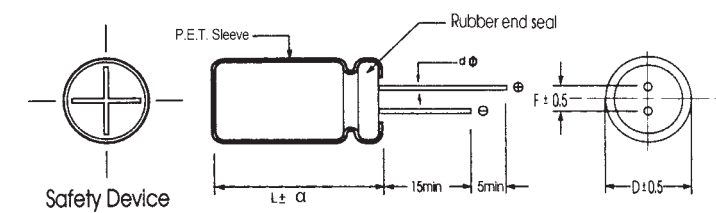

D φ	8	10~13	
F	3.5	5.0	5.0
d φ	0.6	0.6	0.6
α	1.5	2.0	

Radial

Case Size

WV (Vdc)	Cap (uF)	Size (mm)	Rated Ripple current (mAmps/105°C /120Hz)
250	22	8x30	200
250	27	8x30	220
250	33	8x30	240
250	39	8x35	270
250	47	8x40	330
250	56	10x35	380
250	68	10x35	435
250	82	10x40	500
250	100	10x45	585
250	120	13x35	620
250	150	13x40	670
350	15	8x30	145
350	22	8x35	185
350	27	8x40	220
350	33	8x40	250
350	39	10x35	300
350	47	10x40	380
350	56	10x45	430
350	68	13x35	480
350	82	13x40	550
350	100	13x45	600
400	15	8x30	170
400	22	8x35	220
400	27	8x40	255
400	27	10x30	255
400	33	8x45	280
400	33	10x30	280
400	39	8x50	330
400	39	10x35	330
400	47	10x40	430
400	47	13x30	430
400	56	10x50	480
400	56	13x30	450
400	68	10x55	550
400	68	13x35	520
400	68	13x40	550

WV (Vdc)	Cap (uF)	Size (mm)	Rated Ripple current (mAmps/105°C /120Hz)
400	82	13x40	580
400	100	13x45	620
400	100	13x50	650
400	120	13x55	750
420	15	8x30	150
420	22	8x35	195
420	27	8x40	230
420	33	8x50	300
420	33	10x35	290
420	39	10x40	315
420	39	13x30	315
420	47	10x40	360
420	47	13x30	360
420	56	10x50	440
420	56	13x30	400
420	68	13x35	470
420	82	13x40	550
420	100	13x50	620
450	12	8x30	135
450	15	8x35	150
450	22	8x40	195
450	22	10x30	195
450	27	8x45	230
450	27	10x30	220
450	33	10x35	255
450	33	10x40	280
450	39	10x40	300
450	39	10x45	315
450	39	10x50	330
450	47	10x50	390
450	56	13x35	420
450	56	13x40	450
450	68	13x40	520
450	68	13x45	550
450	82	13x45	570

LY Series

Features

- ◆ Endurance: 105°C 5000hours.
- ◆ Suitable for slim application

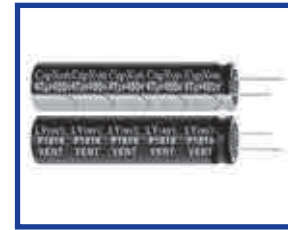

Specifications

Item	Performance Characteristics
Operating Temperature Range	-25~+105°C
Rated Voltage Range	250~450 VDC
Capacitance Range	12~150μF
Capacitance Tolerance	±20%(120Hz,+20°C)
Leakage Current (+20°C,max.)	$I \leq 3 \sqrt{CV}$ (μA) (After 5 minute with rated working voltage applied.) I= Leakage Current(μA) C= Rated Capacitance V= Rated voltage(V)
Dissipation Factor (tan δ , at 20°C , 120Hz)	Working Voltage(VDC) 250 350 400 420 450
	D.F.(%)max. 15 15 15 20 20
Low Temperature Characteristics (at 120Hz)	Impedance ratio max
	Working voltage(VDC) 250 350~450 Z-25°C / Z+20°C 3 8
Endurance	Test condition Duration time : 5000hrs Ambient temperature : +105°C Applied voltage : Rated DC working voltage After test requirement at +20°C Capacitance change : ≤ ±20% of the initial measured value Dissipation factor : ≤200% of the initial specified value Leakage current : ≤The initial specified value

Radial

Multiplier for Ripple Current vs. Frequency

Frequency(Hz)	60	120	400	1K	100K
Coefficient 250~350VV	0.8	1.00	1.20	1.30	1.40
Coefficient 400~450VV	0.8	1.00	1.25	1.40	1.50

Diagram of Dimensions:(unit:mm)

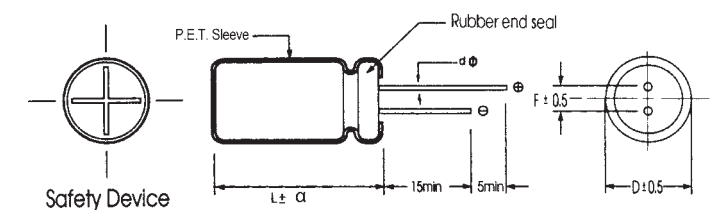

Dφ	8	10~13	
F	3.5	5.0	5.0
dφ	0.6	0.6	0.6
α	1.5	2.0	

Case Size

WV (Vdc)	Cap (uF)	Size (mm)	Rated Ripple current (mA _{rms} /105°C /120Hz)
250	22	8x30	130
250	27	8x30	150
250	33	8x35	170
250	39	8x40	200
250	47	8x45	220
250	56	10x35	260
250	56	10x40	300
250	68	10x40	350
250	82	10x45	480
250	100	10x50	550
250	120	13x40	570
250	150	13x45	620
350	15	8x30	110
350	22	8x35	150
350	27	8x40	165
350	33	8x45	195
350	39	10x40	280
350	47	10x45	330
350	56	10x50	380
350	68	13x35	425
350	68	13x40	450
350	82	13x40	500
350	100	13x50	520
400	15	8x30	120
400	22	8x35	160
400	27	8x40	195
400	27	10x30	195
400	33	8x45	250
400	33	10x30	250
400	39	8x50	280
400	39	10x40	300
400	47	10x45	350
400	47	13x30	330
400	56	10x50	400
400	56	13x30	380
400	56	13x35	420
400	68	13x35	440

WV (Vdc)	Cap (uF)	Size (mm)	Rated Ripple current (mA _{rms} /105°C /120Hz)
400	68	13x40	460
400	82	13x45	520
400	100	13x50	580
400	120	13x60	680
420	15	8x30	100
420	22	8x40	180
420	27	8x45	200
420	33	10x35	230
420	39	10x45	275
420	39	13x30	275
420	47	10x45	330
420	47	13x35	360
420	56	10x55	420
420	56	13x35	410
420	68	13x40	450
420	82	13x45	500
420	100	13x50	600
450	12	8x30	110
450	15	8x35	120
450	22	8x45	160
450	22	10x30	150
450	27	8x50	190
450	27	10x35	180
450	33	10x40	220
450	33	10x45	235
450	33	10x50	250
450	39	10x45	260
450	39	10x50	290
450	39	13x35	290
450	47	10x55	350
450	47	13x35	350
450	56	13x35	400
450	56	13x40	425
450	68	13x45	470
450	68	13x50	500
450	82	13x50	530

HY Series

Features

- ◆ Endurance: 105°C 10000hours.
- ◆ Suitable for slim application
- ◆ High ripple current

LY Long life, high ripple current → **HY**

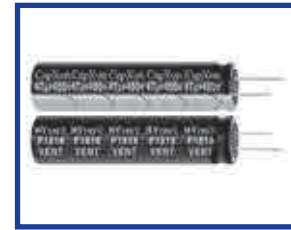

Specifications

Item	Performance Characteristics		
Operating Temperature Range	-25 to +105°C		
Rated Voltage Range	250~450VDC		
Capacitance Range	12 ~ 120 μF		
Capacitance Tolerance	± 20% (120Hz, +20°C)		
Leakage Current (+20°C, max.)	$I \leq 3 \sqrt{CV}$ (μA) (After 5 minute with rated working voltage applied.) I= Leakage Current(μA) C= Rated Capacitance V= Rated voltage(V)		
Dissipation Factor (tan δ , at 20°C , 120Hz)	Working Voltage(VDC)	250~400	420~450
	D.F.(%)max.	20	25
Low Temperature Characteristics (at 120Hz)	Impedance ratio max		
	Working voltage(VDC)	250	350~450
Endurance	Z-25°C / Z+20°C	3	8
	Test condition Duration time : 10000hrs Ambient temperature : +105°C Applied voltage : Rated DC working voltage After test requirement at +20°C Capacitance change : ≤ ±20% of the initial measured value Dissipation factor : ≤ 200% of the initial specified value Leakage current : ≤ The initial specified value		

Radial

Multiplier for Ripple Current vs. Frequency

Frequency(Hz)	60	120	400	1K	100K	
Coefficient	250~350WV	0.8	1.00	1.20	1.30	1.40
	400~450WV	0.8	1.00	1.25	1.40	1.50

Diagram of Dimensions:(unit:mm)

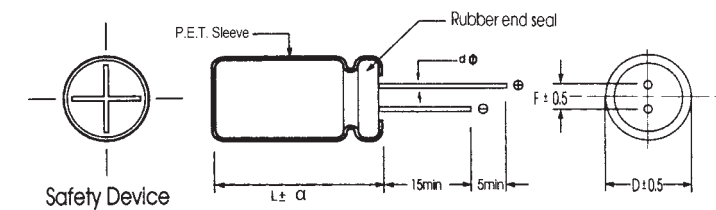

Dφ	8	10~13	14.5	15
F	3.5	5.0	7.5	25
dφ	0.6	0.6	0.8	28
α	1.5	2.0		

Case Size

WV (Vdc)	Cap (uF)	Size (mm)	Rated Ripple current (mAmps/105°C /120Hz)
250	22	8x35	140
250	27	8x40	165
250	27	10x30	165
250	33	10x30	180
250	39	10x35	210
250	47	10x40	280
250	47	13x30	260
250	56	10x45	330
250	56	13x35	330
250	68	10x50	380
250	68	13x35	370
250	82	10x60	490
250	82	13x40	465
250	100	13x45	500
250	120	13x50	580
350	12	8x30	100
350	15	8x35	130
350	22	8x40	165
350	27	10x30	185
350	33	10x35	200
350	39	10x40	285
350	39	13x30	285
350	46	13x35	360
350	47	10x45	340
350	47	13x30	330
350	56	10x50	380
350	68	10x60	450
350	68	13x40	430
350	82	13x45	520
350	100	13x50	580
400	12	8x30	130
400	15	8x35	180
400	22	8x45	230
400	27	10x30	240
400	33	10x35	290

WV (Vdc)	Cap (uF)	Size (mm)	Rated Ripple current (mAmps/105°C /120Hz)
400	39	10x40	400
400	39	13x30	400
400	47	10x45	450
400	47	13x30	440
400	56	10x50	520
400	56	13x35	500
400	68	13x40	580
400	82	13x45	650
400	100	13x50	680
420	12	8x30	140
420	15	8x35	170
420	22	8x50	250
420	27	10x35	270
420	33	10x40	370
420	39	10x45	410
420	39	13x30	390
420	47	10x50	420
420	47	13x35	450
420	56	10x60	530
420	56	13x40	520
420	68	13x45	580
420	82	13x50	660
450	12	8x30	150
450	15	8x40	190
450	22	10x30	220
450	27	10x40	280
450	33	10x40	360
450	33	13x30	370
450	39	10x50	410
450	39	13x35	420
450	47	10x50	420
450	47	13x40	480
450	56	13x45	530
450	68	13x50	620
450	82	13x55	680

NP Series Non-polarized 85°C

Features

- ◆ NP Series for crossover networks of high-pitched, mean and low-pitched sounds in high-fidelity sound systems.
- ◆ The series offers excellent frequency characteristics and minimal capacitance deviation with frequency.
- ◆ RoHS Compliant



Specifications

Item	Performance Characteristics	
Operating Temperature Range	-40 to +85°C	-25 to +85°C
Rated Voltage Range	6.3 to 100 VDC	160 to 250 VDC
Capacitance Range	0.47 to 3300 μF	0.47 to 47 μF
Capacitance Tolerance	±20%(120Hz,+20°C)	
Leakage Current (+20°C,max.)	I ≤ 0.03 CV or 3 (μA) After 1 minute whichever is greater measured with rated working voltage applied.	
Dissipation Factor (tan δ , at 20°C , 120Hz)	Working Voltage(VDC)	6.3 10 16 25 35 50 63 100 160 200 250
	D.F. (%)max.	25 25 20 15 15 13 10 10 15 15 20
Low Temperature Characteristics (at 120Hz)	For Capacitance > 1000 uF, add 2% per another 1000 uF	
	Impedance ratio max	
	Working Voltage(VDC)	6.3 10 16 25 35 50 63 100
	Z-25°C / Z+20°C	4 3 2 2 2 2 2 2
	Z-40°C / Z+20°C	8 6 4 4 3 3 3 3
Endurance	Working Voltage(VDC)	160 200 250
	Z-25°C / Z+20°C	2 2 3
	For Capacitance > 1000 uF, add 0.5 per another 1000 uF for -25°C / +20°C add 1 per another 1000 uF for -40°C / +20°C	
Shelf Life	Test conditions	
	Duration time : 1000Hrs Ambient temperature : +85°C Applied voltage : None After test requirements at +20°C: Same limits as Endurance. Pre-treatment for measurements shall be conducted after application of DC working voltage for 30 minutes.	

Multiplier for Ripple Current vs. Frequency

CAP(μF)\Frequency(Hz)	50(60)	120	400	1K	10K	50K~100K
CAP ≤ 10	0.8	1	1.30	1.45	1.65	1.70
10 < CAP ≤ 100	0.8	1	1.23	1.36	1.48	1.53
100 < CAP ≤ 1000	0.8	1	1.16	1.25	1.35	1.38
1000 < CAP	0.8	1	1.11	1.17	1.25	1.28

Diagram of Dimensions:(unit:mm)

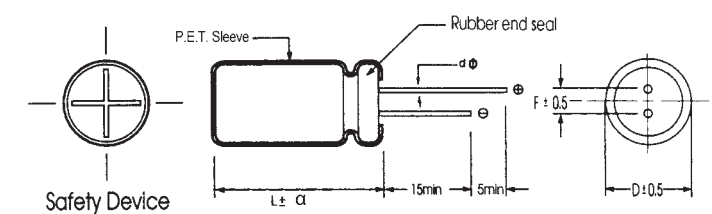

D φ	5	6.3	8	10	13	16	18
F	2.0	2.5	3.5	5.0	5.0	7.5	7.5
d φ	0.5	L < 20		L ≥ 20		0.6	0.8
		0.5	0.6				
α	D < 16	D = 16		D = 18		D > 18	
		L: 25~35.5	L < 25 and L ≥ 40	L: 25~31.5	L < 25 and L ≥ 35.5		
	1.5	1.5	2.0	1.5	2.0	2.0	

Non-polarized type

Case Size

WV (Vdc)	Cap (uF)	Size (mm)	Rated Ripple current (mA rms/85°C /120Hz)
6.3	100	6.3x11	120
6.3	220	6.3x11	175
6.3	330	8x11.5	250
6.3	470	10x12.5	330
6.3	1000	10x20	650
6.3	2200	13x20	850
6.3	3300	16x25	970
10	22	5x11	55
10	33	5x11	66
10	47	5x11	82
10	100	6.3x11	125
10	220	8x11.5	205
10	330	10x12.5	270
10	330	10x16	300
10	470	10x16	388
10	1000	13x20	700
10	2200	16x25	1000
10	3300	18x35.5	1300
16	22	5x11	57
16	33	5x11	75
16	47	6.3x11	97
16	100	8x11.5	162
16	220	10x12.5	270
16	330	10x16	350
16	470	10x20	455
16	1000	13x20	730
16	1000	13x25	800
16	2200	16x31.5	1100
25	10	5x11	34
25	22	6.3x11	65
25	33	6.3x11	86
25	47	6.3x11	100
25	100	8x11.5	175
25	220	10x12.5	295
25	220	10x16	310
25	330	10x20	440
25	470	13x20	530
35	10	5x11	43
35	22	6.3x11	75
35	33	8x11.5	105
35	47	8x11.5	120
35	100	10x12.5	210
35	100	10x16	230
35	220	10x20	400
35	330	13x20	495
35	470	13x25	655
50	0.47	5x11	11
50	1	5x11	17
50	2.2	5x11	25
50	3.3	5x11	27
50	4.7	5x11	34
50	10	6.3x11	52
50	22	8x11.5	92
50	33	8x11.5	109

WV (Vdc)	Cap (uF)	Size (mm)	Rated Ripple current (mA rms/85°C /120Hz)
50	47	10x12.5	150
50	100	10x20	265
50	220	13x20	475
50	330	13x25	560
63	0.47	5x11	12
63	1	5x11	18
63	2.2	5x11	26
63	3.3	6.3x11	28
63	4.7	6.3x11	34
63	10	6.3x11	57
63	22	8x11.5	97
63	33	10x12.5	140
63	47	10x16	180
63	100	13x20	320
63	220	13x25	510
100	0.47	5x11	14
100	1	5x11	21
100	2.2	5x11	34
100	3.3	6.3x11	39
100	4.7	8x11.5	47
100	10	8x11.5	71
100	22	10x16	140
100	33	10x16	190
100	33	10x20	220
100	47	10x20	195
100	47	13x20	240
100	100	16x25	425
100	220	16x25	520
100	220	16x31.5	550
160	0.47	5x11	17
160	1	6.3x11	25
160	2.2	8x11.5	38
160	3.3	8x11.5	43
160	4.7	10x12.5	52
160	10	10x16	89
160	22	13x20	155
160	33	13x20	230
160	47	13x25	250
200	0.47	6.3x11	21
200	1	8x11.5	28
200	2.2	8x11.5	42
200	3.3	10x12.5	46
200	4.7	10x16	56
200	10	10x20	95
200	22	13x20	180
200	33	13x25	250
250	0.47	6.3x11	28
250	1	8x11.5	32
250	2.2	10x12.5	48
250	3.3	10x16	57
250	4.7	10x20	88
250	10	10x20	130
250	22	13x25	224
250	33	16x25	305

NK Series Non-polarized 105°C

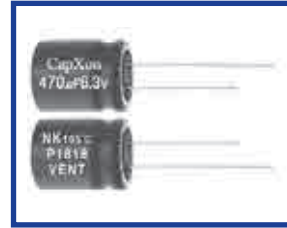

Features

- ◆ NK Series for crossover networks of high-pitched, mean and low-pitched sounds in high-fidelity sound systems.
- ◆ The series offers excellent frequency characteristics and minimal capacitance deviation with frequency.
- ◆ RoHS Compliant

Specifications

Item	Performance Characteristics	
Operating Temperature Range	-40 to +105°C	-25 to +105°C
Rated Voltage Range	6.3 to 100 VDC	160 to 250 VDC
Capacitance Range	0.47 to 3300 µF	0.47 to 47 µF
Capacitance Tolerance	±20%(120Hz,+20°C)	
Leakage Current (+20°C,max.)	I ≤ 0.03 CV or 3(µA) After 1 minute whichever is greater measured with rated working voltage applied.	
Dissipation Factor (tan δ , at 20°C , 120Hz)	Working Voltage(VDC)	6.3 10 16 25 35 50 63 100 160 200 250
	D.F. (%)max.	25 25 20 15 15 13 10 10 15 15 20
Low Temperature Characteristics (at 120Hz)	For Capacitance > 1000 uF, add 2% per another 1000 uF	
	Impedance ratio max	
	Working Voltage(VDC)	6.3 10 16 25 35 50 63 100
	Z-25°C/Z+20°C	4 3 2 2 2 2 2 2
Endurance	Z-40°C/Z+20°C	8 6 4 3 3 3 3 3
	For Capacitance > 1000 uF, add 0.5 per another 1000 uF for -25°C/+20°C add 1 per another 1000 uF for -40°C/+20°C	
	Working Voltage(VDC)	160 200 250
	Z-25°C/Z+20°C	2 2 3
Shelf Life	Test conditions	
	Duration time : 2000Hrs Ambient temperature : +105°C Applied voltage : Rated DC working voltage Each 250 hours, we will reserve the terminal and test the characteristics. After test requirement at +20°C Capacitance change : ≤ ±20% of the initial measured value Dissipation factor : ≤ 150% of the initial specified value Leakage current : ≤ The initial specified value	
Shelf Life	Test conditions	
	Duration time : 1000Hrs Ambient temperature : +105°C Applied voltage : None After test requirement at +20°C: Same limits as Endurance. Pre-treatment for measurements shall be conducted after application of DC working voltage for 30 minutes.	

Multiplier for Ripple Current vs. Frequency

CAP(µF)\Frequency(Hz)	50(60)	120	400	1K	10K	50K~100K
CAP ≤ 10	0.8	1	1.30	1.45	1.65	1.70
10 < CAP ≤ 100	0.8	1	1.23	1.36	1.48	1.53
100 < CAP ≤ 1000	0.8	1	1.16	1.25	1.35	1.38
1000 < CAP	0.8	1	1.11	1.17	1.25	1.28

Diagram of Dimensions:(unit:mm)

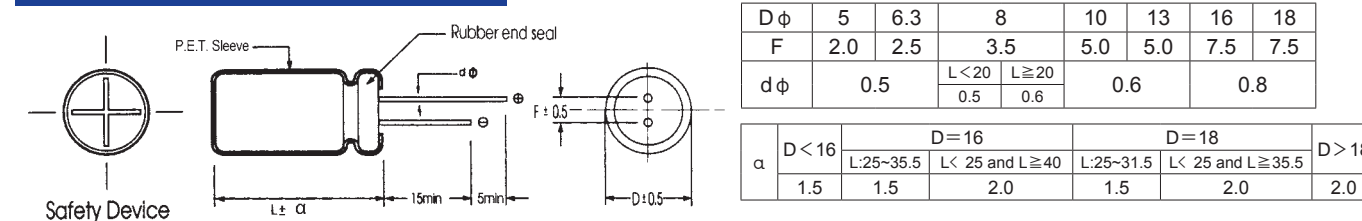

Non-polarized type

Case Size

WV (Vdc)	Cap (uF)	Size (mm)	Rated Ripple current (mAmps/105°C /120Hz)
6.3	100	5x11	99
6.3	220	8x11.5	149
6.3	330	8x11.5	190
6.3	470	10x12.5	280
6.3	1000	10x16	352
6.3	2200	13x20	645
6.3	3300	16x25	950
10	33	5x11	59
10	47	5x11	79
10	100	6.3x11	99
10	220	8x11.5	157
10	330	10x12.5	235
10	470	10x12.5	290
10	1000	10x20	430
10	2200	16x25	830
10	3300	16x31.5	1150
16	22	5x11	53
16	33	5x11	62
16	47	6.3x11	90
16	100	6.3x11	99
16	100	8x11.5	123
16	220	8x11.5	200
16	220	10x12.5	234
16	330	10x12.5	255
16	470	10x16	360
16	1000	13x20	511
16	2200	16x31.5	950
25	10	5x11	34
25	22	6.3x11	55
25	33	6.3x11	72
25	47	6.3x11	96
25	100	8x11.5	152
25	220	10x12.5	245
25	330	10x16	310
25	470	13x20	420
35	10	5x11	38
35	22	6.3x11	65
35	33	8x11.5	75
35	47	8x11.5	107
35	100	10x12.5	198
35	220	10x20	320
35	330	13x20	370
35	470	13x25	495
50	0.47	5x11	8
50	1	5x11	12
50	2.2	5x11	17
50	3.3	5x11	23
50	4.7	5x11	30
50	10	6.3x11	50
50	22	8x11.5	85
50	33	8x11.5	89
50	47	10x12.5	123
50	100	10x16	198
50	100	10x20	220

WV (Vdc)	Cap (uF)	Size (mm)	Rated Ripple current (mAmps/105°C /120Hz)
50	220	13x20	340
50	220	13x25	375
50	330	16x25	500
63	0.47	5x11	9
63	1	5x11	14
63	2.2	5x11	20
63	3.3	6.3x11	25
63	4.7	6.3x11	30
63	10	6.3x11	52
63	22	8x11.5	88
63	22	10x12.5	92
63	33	10x12.5	115
63	47	10x16	150
63	100	13x20	295
63	220	13x25	420
100	0.47	5x11	10
100	1	5x11	15
100	2.2	5x11	20
100	2.2	6.3x11	22
100	3.3	6.3x11	28
100	4.7	6.3x11	32
100	4.7	8x11.5	36
100	10	8x11.5	52
100	10	10x12.5	55
100	22	10x16	120
100	33	10x20	175
100	47	13x20	187
100	100	16x25	399
160	0.47	5x11	12
160	1	6.3x11	18
160	2.2	8x11.5	28
160	3.3	8x11.5	37
160	4.7	10x12.5	45
160	10	10x16	79
160	22	13x20	140
160	33	13x20	200
160	47	13x25	215
200	0.47	6.3x11	17
200	1	8x11.5	21
200	2.2	8x11.5	32
200	3.3	10x12.5	40
200	4.7	10x16	52
200	10	10x20	86
200	22	13x20	160
200	33	13x25	213
250	0.47	6.3x11	22
250	1	8x11.5	25
250	2.2	10x12.5	39
250	3.3	10x16	43
250	4.7	10x20	65
250	10	10x20	109
250	22	13x25	189
250	33	16x25	250

SW Series 5mm 85°C

Features

- ◆ Design for audio equipment.
- ◆ RoHS Compliant

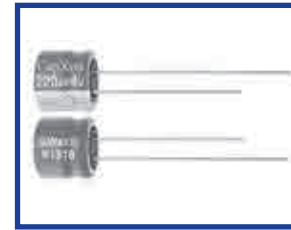

For Audio Equipment

Specifications

Item	Performance Characteristics
Operating Temperature Range	-40~+85°C
Rated Voltage Range	4~50 VDC
Capacitance Range	0.1 to 470 μ F
Capacitance Tolerance	±20%(120Hz,+20°C)
Leakage Current (+20°C,max.)	I=0.01 CV or 3 (μ A) (After 2 minute with rated working voltage applied.)
Dissipation Factor (tan δ , at 20°C , 120Hz)	Working Voltage(VDC) 4 6.3 10 16 25 35 50
	D.F.(%)max. 35 24 20 16 14 12 10
Low Temperature Characteristics (at 120Hz)	Impedance ratio max
	Working voltage(VDC) 4 6.3 10 16 25 35 50
	Z-25°C / Z+20°C 7 4 3 2 2 2 2
	Z-40°C / Z+20°C 15 8 6 4 4 3 3
Endurance	Test condition
	Duration time :1000 Hrs
	Ambient temperature :+85°C
	Applied voltage :Rated DC working voltage
	After test requirement at +20°C
	Capacitance change : ≤ ±20% of the initial measured value
Dissipation factor : ≤200% of the initial specified value	
Leakage current : ≤The initial specified value	
Shelf Life	Test condition
	Duration time :1000 Hrs
	Ambient temperature :+85°C
	Applied voltage :None
	After test requirement at +20°C :Same limits as Endurance.
Pre-treatment for measurements shall be conducted after application of DC working voltage for 30 minutes.	

Multiplier for Ripple Current vs. Frequency

CAP(μ F)\Frequency(Hz)	50	120	300	1K	10K
Multiplier	0.70	1.00	1.17	1.36	1.50

Diagram of Dimension:(unit:mm)

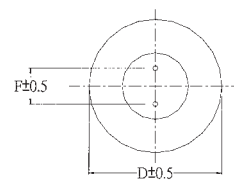
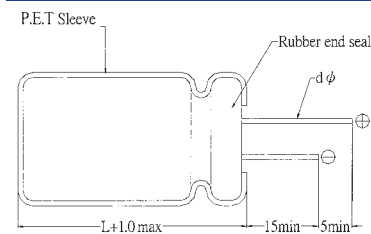

D φ	4	5	6.3	8
F	1.5	2.0	2.5	3.5
d φ	0.45		0.50	

Case Size

WV (Vdc)	Cap (uF)	Size (mm)	Rated Ripple current (mA rms/85°C /120Hz)
4	33	4x5	30
4	47	4x5	33
4	100	5x5	54
4	220	6.3x5	87
4	330	8x5	143
4	470	8x5	185
6.3	22	4x5	26
6.3	33	5x5	37
6.3	47	5x5	42
6.3	100	6.3x5	67
6.3	220	8x5	112
6.3	330	8x5	170
10	22	5x5	33
10	33	5x5	40
10	47	6.3x5	49
10	100	8x5	80
10	220	8x5	136
16	10	4x5	21
16	22	5x5	36
16	33	6.3x5	47
16	47	6.3x5	58
16	100	8x5	92

WV (Vdc)	Cap (uF)	Size (mm)	Rated Ripple current (mA rms/85°C /120Hz)
25	4.7	4x5	15
25	10	5x5	27
25	22	6.3x5	43
25	33	6.3x5	52
25	47	8x5	70
25	100	8x5	109
35	3.3	4x5	13
35	4.7	4x5	18
35	10	5x5	29
35	22	6.3x5	46
35	33	8x5	62
35	47	8x5	81
50	0.1	4x5	1.2
50	0.22	4x5	2.3
50	0.33	4x5	3
50	0.47	4x5	3.9
50	1	4x5	7.3
50	2.2	4x5	11
50	3.3	4x5	15
50	4.7	5x5	20
50	10	6.3x5	31
50	22	8x5	52
50	33	8x5	70

SR Series 7mm 85°C

Features

- ◆ Design for audio equipments
- ◆ Lineally suited for very compact audio products
- ◆ RoHS compliance.



For Audio Equipment

Specifications

Item	Performance Characteristics
Operating Temperature Range	-40~+85°C
Rated Voltage Range	6.3~50 VDC
Capacitance Range	0.1 to 220 μ F
Capacitance Tolerance	±20%(120Hz,+20°C)
Leakage Current (+20°C,max.)	I ≤ 0.01CV or 3(μA) After 2 minutes with rated working voltage applied.
Dissipation Factor (tan δ , at 20°C , 120Hz)	Working Voltage(VDC) 6.3 10 16 25 35 50
	D.F.(%)max. 24 20 16 14 12 10
Low Temperature Characteristics (at 120Hz)	Impedance ratio max
	Working voltage(VDC) 6.3 10 16 25 35 50
	Z-25°C / Z+20°C 4 3 2 2 2 2
Z-40°C / Z+20°C 8 6 4 4 3 3	
Endurance	Test condition
	Duration time :1000Hrs
	Ambient temperature :+85°C
	Applied voltage :Rated DC working voltage
	After test requirements at +20°C
	Capacitance change :≤ ±20% of the initial measured value
Dissipation factor :≤ 200% of the initial specified value	
Leakage current :≤ The initial specified value	
Shelf Life	Test condition
	Duration time :1000Hrs
	Ambient temperature :+85°C
	Applied voltage :None
	After test requirement at +20°C :Same limits as Endurance.
Pre-treatment for measurements shall be conducted after application of DC working voltage for 30 minutes.	

Multiplier for Ripple Current vs. Frequency

CAP(μF)\Frequency(Hz)	50	120	300	1K	10K
CAP≤10	0.70	1.00	1.17	1.36	1.50

Diagram of Dimension:(unit:mm)

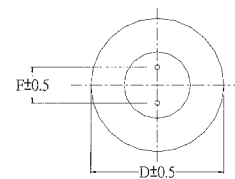
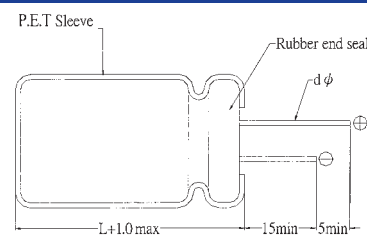

D φ	4	5	6.3
F	1.5	2.0	2.5
d φ	0.45		0.50

Case Size

WV (Vdc)	Cap (uF)	Size (mm)	Rated Ripple current (mA _{rms} /85°C /120Hz)
6.3	22	4x7	34
6.3	33	4x7	40
6.3	47	4x7	47
6.3	100	5x7	76
6.3	220	6.3x7	124
10	22	4x7	35
10	33	4x7	45
10	47	5x7	59
10	100	6.3x7	88
16	10	4x7	28
16	22	4x7	39
16	33	5x7	55
16	47	5x7	65
16	100	6.3x7	98
25	10	4x7	29
25	22	5x7	49

WV (Vdc)	Cap (uF)	Size (mm)	Rated Ripple current (mA _{rms} /85°C /120Hz)
25	33	5x7	55
25	47	6.3x7	71
35	4.7	4x7	23
35	10	4x7	31
35	22	5x7	49
35	33	6.3x7	65
50	0.1	4x7	1.1
50	0.22	4x7	2.6
50	0.33	4x7	3.5
50	0.47	4x7	5
50	1	4x7	10
50	2.2	4x7	18
50	3.3	4x7	23
50	4.7	4x7	26
50	10	5x7	35
50	22	6.3x7	58

RW Series 85°C

Features

- ◆ Standard for audio equipment.
- ◆ RoHS Compliant



For Audio Equipment

Specifications

Item	Performance Characteristics																											
Operating Temperature Range	-40~+85°C																											
Rated Voltage Range	6.3~100 VDC																											
Capacitance Range	0.1 to 33000 µF																											
Capacitance Tolerance	±20%(120Hz,+20°C)																											
Leakage Current (+20°C,max.)	$I \leq 0.01 CV$ or 3 (µA) (After 1 minute with rated working voltage applied.)																											
Dissipation Factor (tan δ , at 20°C , 120Hz)	<table border="1"> <tr> <td>Working Voltage(VDC)</td> <td>6.3</td> <td>10</td> <td>16</td> <td>25</td> <td>35</td> <td>50</td> <td>63</td> <td>100</td> </tr> <tr> <td>D.F.(%)max.</td> <td>28</td> <td>24</td> <td>20</td> <td>16</td> <td>14</td> <td>12</td> <td>10</td> <td>8</td> </tr> </table>	Working Voltage(VDC)	6.3	10	16	25	35	50	63	100	D.F.(%)max.	28	24	20	16	14	12	10	8									
	Working Voltage(VDC)	6.3	10	16	25	35	50	63	100																			
D.F.(%)max.	28	24	20	16	14	12	10	8																				
For capacitance > 1000 µF, add 2% per another 1000 µF.																												
Low Temperature Characteristics (at 120Hz)	Impedance ratio max																											
	<table border="1"> <tr> <td>Working voltage(VDC)</td> <td>6.3</td> <td>10</td> <td>16</td> <td>25</td> <td>35</td> <td>50</td> <td>63</td> <td>100</td> </tr> <tr> <td>Z-25°C / Z+20°C</td> <td>5</td> <td>4</td> <td>3</td> <td>2</td> <td>2</td> <td>2</td> <td>2</td> <td>2</td> </tr> <tr> <td>Z-40°C / Z+20°C</td> <td>12</td> <td>10</td> <td>8</td> <td>5</td> <td>4</td> <td>3</td> <td>3</td> <td>3</td> </tr> </table>	Working voltage(VDC)	6.3	10	16	25	35	50	63	100	Z-25°C / Z+20°C	5	4	3	2	2	2	2	2	Z-40°C / Z+20°C	12	10	8	5	4	3	3	3
	Working voltage(VDC)	6.3	10	16	25	35	50	63	100																			
Z-25°C / Z+20°C	5	4	3	2	2	2	2	2																				
Z-40°C / Z+20°C	12	10	8	5	4	3	3	3																				
Endurance	Test condition																											
	Duration time :2000 Hrs																											
	Ambient temperature :+85°C																											
	Applied voltage :Rated DC working voltage																											
	After test requirement at +20°C																											
	Capacitance change : ≤ ±20% of the initial measured value																											
Dissipation factor : ≤200% of the initial specified value																												
Leakage current : ≤The initial specified value																												
Shelf Life	Test condition																											
	Duration time :1000 Hrs																											
	Ambient temperature :+85°C																											
	Applied voltage :None																											
	After test requirement at +20°C :Same limits as Endurance.																											
	Pre-treatment for measurements shall be conducted after application of DC working voltage for 30 minutes.																											

Multiplier for Ripple Current vs. Frequency

CAP(µF)\Frequency(Hz)	50(60)	120	300	1K	10K
CAP≤47	0.75	1.00	1.35	1.57	1.20
100 < CAP ≤ 470	0.80	1.00	1.23	1.34	1.50
1000 ≤ CAP ≤ 33000	0.85	1.00	1.10	1.13	1.15

Diagram of Dimension:(unit:mm)

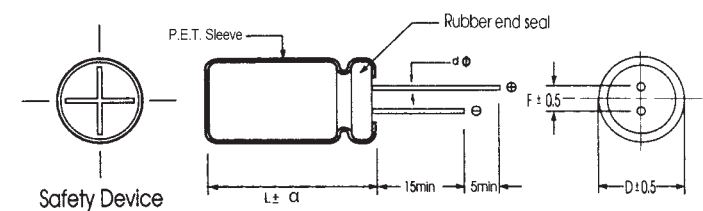

D φ	5	6.3	8	10	13	16	18	22
F	2.0	2.5	3.5	5.0	5.0	7.5	7.5	10
d φ	0.5		L < 20 0.5	L ≥ 20 0.6	0.6		0.8	
	0.5		0.6		0.6		0.8	
α	D < 16		D = 16		D = 18		D > 18	
	L:25~35.5		L < 25 and L ≥ 40		L:25~31.5		L < 25 and L ≥ 35.5	
	1.5	1.5	2.0	1.5	2.0	2.0	2.0	2.0

Case Size

WV (Vdc)	Cap (uF)	Size (mm)	Rated Ripple current (mA _{rms} /85°C /120Hz)
6.3	330	6.3x11	282
6.3	470	6.3x11	330
6.3	1000	8x11.5	560
6.3	2200	10x20	1015
6.3	3300	10x20	1245
6.3	4700	13x20	1435
6.3	6800	13x25	1600
6.3	10000	16x25	2000
6.3	15000	16x35.5	2620
6.3	22000	18x40	3220
6.3	33000	22x50	3900
10	100	5x11	162
10	220	6.3x11	247
10	330	6.3x11	300
10	470	6.3x11	355
10	1000	10x12.5	600
10	2200	10x20	1075
10	3300	13x20	1410
10	4700	13x25	1800
10	6800	16x25	2200
10	10000	16x35.5	2450
10	15000	18x35.5	2900
10	22000	22x40	3700
10	33000	22x50	4300
16	100	5x11	155
16	220	6.3x11	265
16	330	8x11.5	365
16	470	8x11.5	445
16	1000	10x16	780
16	2200	13x20	1300
16	3300	13x25	1700
16	4700	16x25	2100
16	6800	16x35.5	2520
16	10000	18x35.5	2670
16	15000	22x40	3400
16	22000	22x50	4200
25	47	5x11	117
25	100	6.3x11	187
25	220	8x11.5	325
25	330	10x12.5	415
25	470	10x12.5	535
25	1000	10x20	950
25	2200	13x25	1550
25	3300	16x25	1675
25	4700	16x31.5	2380
25	6800	18x35.5	2650
25	10000	22x40	3000
25	15000	22x50	3800
35	33	5x11	107
35	47	5x11	125
35	100	6.3x11	205
35	220	10x12.5	370
35	330	10x12.5	475
35	470	10x16	630
35	1000	13x20	1120
35	2200	16x25	1650
35	3300	16x35.5	2270
35	4700	18x35.5	2540
35	6800	22x40	3000

WV (Vdc)	Cap (uF)	Size (mm)	Rated Ripple current (mA _{rms} /85°C /120Hz)
50	0.1	5x11	2.1
50	0.22	5x11	2.7
50	0.33	5x11	4.2
50	0.47	5x11	6
50	1	5x11	12
50	2.2	5x11	24
50	3.3	5x11	35
50	4.7	5x11	41
50	10	5x11	65
50	22	5x11	97
50	33	5x11	120
50	47	6.3x11	150
50	100	8x11.5	255
50	220	10x12.5	417
50	330	10x16	580
50	470	13x20	770
50	1000	13x25	1320
50	2200	16x35.5	2090
50	3300	18x35.5	2430
50	4700	22x40	2900
50	6800	22x50	3500
63	0.1	5x11	1.5
63	0.22	5x11	3
63	0.33	5x11	5
63	0.47	5x11	7
63	1	5x11	15
63	2.2	5x11	28
63	3.3	5x11	35
63	4.7	5x11	45
63	10	5x11	70
63	22	5x11	107
63	33	6.3x11	137
63	47	6.3x11	172
63	100	10x12.5	300
63	220	10x16	485
63	330	10x20	670
63	470	13x20	880
63	1000	16x25	1350
63	2200	18x35.5	2220
63	3300	22x40	2700
63	4700	22x50	3400
100	0.1	5x11	2.1
100	0.22	5x11	4.7
100	0.33	5x11	7.5
100	0.47	5x11	11
100	1	5x11	21
100	2.2	5x11	31
100	3.3	5x11	40
100	4.7	5x11	46
100	10	6.3x11	75
100	22	6.3x11	125
100	33	8x11.5	165
100	47	10x12.5	220
100	100	10x20	370
100	220	13x25	615
100	330	13x25	755
100	470	16x25	1000
100	1000	18x40	1500
100	2200	22x50	2400

NR Series 85°C

Features

- ◆ Standard non polarity series for using in polarity reversal circuits.
- ◆ Design For audio equipment.
- ◆ RoHS Compliant

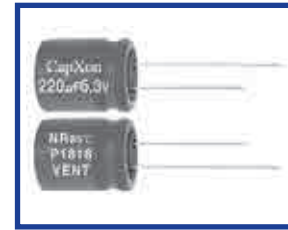

For Audio Equipment

Specifications

Item	Performance Characteristics								
Operating Temperature Range	-40~+85°C								
Rated Voltage Range	6.3~100 VDC								
Capacitance Range	0.15 to 1000 μ F								
Capacitance Tolerance	$\pm 20\%$ (120Hz, +20°C)								
Leakage Current (+20°C, max.)	$I \leq 0.03 CV$ or 3 (μ A) (After 1 minute with rated working voltage applied.)								
Dissipation Factor ($\tan \delta$, at 20°C , 120Hz)	Working Voltage(VDC)	6.3	10	16	25	35	50	63	100
	D.F.(%)max.	24	20	16	16	14	12	10	10
Low Temperature Characteristics (at 120Hz)	Impedance ratio max (at: 120Hz)								
	Working voltage(VDC)	6.3	10	16	25	35	50	63	100
	Z-25°C / Z+20°C	4	3	2	2	2	2	2	2
	Z-40°C / Z+20°C	8	6	4	4	3	3	3	3
Endurance	Test condition Duration time : 2000 Hrs Ambient temperature : +85°C Applied voltage : Rated DC working voltage Each 250 hours, we will reserve the terminal and test the characteristics After test requirement at +20°C Capacitance change : within $\leq \pm 20\%$ of the initial measured value Dissipation factor : $\leq 200\%$ of the initial specified value Leakage current : \leq The initial specified value								
Shelf Life	Test condition Duration time : 1000 Hrs Ambient temperature : +85°C Applied voltage : None After test requirement at +20°C: Same limits as Endurance. Pre-treatment for measurements shall be conducted after application of DC working voltage for 30 minutes.								

Multiplier for Ripple Current vs. Frequency

CAP(μ F)\Frequency(Hz)	50(60)	120	400	1K	10K	50K~100K
CAP ≤ 10	0.8	1	1.30	1.45	1.65	1.70
10 < CAP ≤ 100	0.8	1	1.23	1.36	1.48	1.53
100 < CAP ≤ 1000	0.8	1	1.16	1.25	1.35	1.38
1000 < CAP	0.8	1	1.11	1.17	1.25	1.28

Diagram of Dimension:(unit:mm)

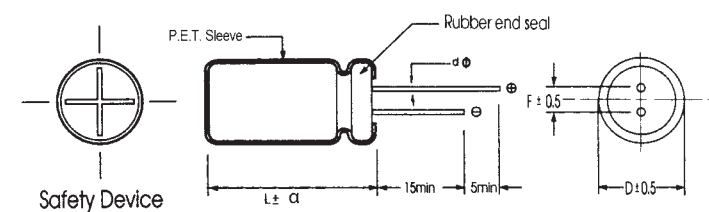

ϕ D	5	6.3	8	10	13	16	
F	2.0	2.5	3.5	5.0	5.0	7.5	
ϕ d	0.5			0.6		0.8	
α	D < 16		D = 16		D = 18		D > 18
	L: 25~35.5	L < 25 and L ≥ 40	L: 25~31.5	L < 25 and L ≥ 35.5			
	1.5	1.5	2.0	1.5	2.0	2.0	

Case Size

WV (Vdc)	Cap (uF)	Size (mm)	Rated Ripple current (mArms/85°C /120Hz)
6.3	33	5x11	62
6.3	47	6.3x11	76
6.3	100	8x11.5	154
6.3	220	10x12.5	245
6.3	330	10x16	330
6.3	470	10x20	360
6.3	1000	13x25	910
10	22	5x11	60
10	33	6.3x11	70
10	47	6.3x11	95
10	100	10x12.5	188
10	220	10x16	294
10	330	10x20	360
10	470	13x20	538
10	1000	16x25	940
16	10	5x11	43
16	22	6.3x11	71
16	33	6.3x11	90
16	47	8x11.5	122
16	100	10x12.5	208
16	220	10x20	360
16	330	13x20	480
16	470	13x25	638
16	1000	16x31.5	1090
25	4.7	5x11	26
25	10	5x11	44
25	22	6.3x11	71
25	33	8x11.5	110
25	47	10x12.5	150
25	100	10x16	250
25	220	13x25	478
25	330	13x25	615
25	470	16x25	720
35	4.7	5x11	34
35	10	6.3x11	48
35	22	8x11.5	96
35	33	10x12.5	135
35	47	10x12.5	154

WV (Vdc)	Cap (uF)	Size (mm)	Rated Ripple current (mArms/85°C /120Hz)
35	100	10x20	275
35	220	13x25	560
35	330	16x25	670
50	0.47	5x11	12
50	1	5x11	18
50	1.8	5x11	22
50	2.2	5x11	27
50	3.3	5x11	29
50	4.7	6.3x11	42
50	10	8x11.5	65
50	22	10x12.5	118
50	33	10x16	155
50	47	10x20	200
50	100	13x25	370
50	220	16x25	645
50	330	16x31.5	760
63	0.47	6.3x11	14
63	1	6.3x11	22
63	1.8	6.3x11	26
63	2.2	6.3x11	33
63	3.3	8x11.5	36
63	4.7	8x11.5	44
63	10	8x11.5	73
63	22	10x12.5	125
63	33	10x16	170
63	47	10x20	215
63	100	13x25	384
100	0.15	6.3x11	13
100	0.47	6.3x11	17
100	1	6.3x11	25
100	1.8	6.3x11	32
100	2.2	6.3x11	39
100	3.3	8x11.5	49
100	4.7	10x12.5	60
100	10	10x16	98
100	22	10x20	165
100	33	13x20	275

SF Series Snap-in Type for Photo Flash

Features

- ◆ SF Series is for photo flash applications that require not only superior volumetric efficiency, low dissipation factor and low leakage current.
- ◆ These capacitors effectively convert electrostatic energy into light.
- ◆ RoHS Compliant



Specifications

Item	Performance Characteristics	
Operating Temperature Range	-20 to +55°C	
Rated Voltage Range	330/350 VDC	
Capacitance Range	150 ~ 1500 μF	
Capacitance Tolerance	-10% ~ +20% (120Hz, +25°C)	
Leakage Current (+20°C,max.)	$I \leq 1 \times C \mu A$ max After 5 minutes	
Dissipation Factor (tan δ , at 20°C , 120Hz)	8% max.	
Charge and Discharge	Test conditions	
	Duration time	:5000 Times
	Ambient temperature	:Room Temperature(5~35°C)
	Applied voltage	:Rated voltage
	Charge and Discharge Cycles	:30 Sec.
	Discharge resistance or via Xe flash tube	:0.7 to 1.0Ω
	After test requirements at +25°C	
Capacitance change	: ≤ ± 10% of the initial measured value	
Dissipation factor	: ≤ 150% of the initial specified value	
Leakage current	: ≤ 150% of the initial specified value	
Shelf Life	Test conditions	
	Duration time	:1000Hrs
	Ambient temperature	:+55°C
	Applied voltage	:None
	After test requirements at +25°C	
	Capacitance change	: ≤ ± 10% of the initial measured value
	Dissipation factor	: ≤ 150% of the initial specified value
Leakage current	: ≤ 150% of the initial specified value	

For Photo Flash

Diagram of Dimensions:(unit:mm)

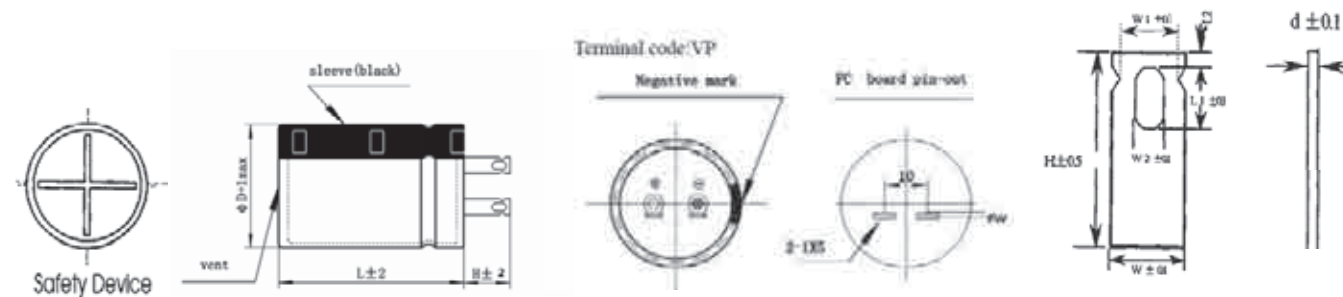

Dφ	H±0.5	L1±0.1	L2±0.2	W±0.2	W1±0.2	W2±0.2	d±0.1
25	6	3.3	1.3	4	3.2	1.8	0.6
30	6	3.3	1	4.6	3.7	2	0.8
35	6	3.3	1	4.6	3.7	2	0.8
40	6	3.3	1	4.6	3.7	2	0.8

Please check with us about individual sizes and dimensions.

RF Series Radial Type for Photo Flash



Features

- ◆ RF Series is for photo flash applications that require not only superior volumetric efficiency, low dissipation factor and low leakage current.
- ◆ These capacitors effectively convert electrostatic energy into light.
- ◆ RoHS Compliant

Specifications

Item	Performance Characteristics
Operating Temperature Range	-20 to +55°C
Rated Voltage Range	330/350 VDC
Capacitance Range	100 ~ 450 μ F
Capacitance Tolerance	-10% ~ +20% (120Hz, +25°C)
Leakage Current (+20°C,max.)	$I \leq 1 \times C \mu A$ max After 5 minutes with rated working voltage applied
Dissipation Factor (tan δ , at 20°C , 120Hz)	8% max.
Charge and Discharge	Test conditions Duration time :5000 Times Ambient temperature :Room Temperature(5~35°C) Applied voltage :Rated voltage Charge and Discharge Cycles :30 Sec. Discharge resistance or via Xe flash tube :0.7 to 1.0 Ω After test requirements at +25°C Capacitance change :≤ ±10% of the initial measured value Dissipation factor :≤ 150% of the initial specified value Leakage current :≤ 150% of the initial specified value
Shelf Life	Test conditions Duration time :1000 Hrs Ambient temperature :+55°C Applied voltage :None

Diagram of Dimensions:(unit:mm)

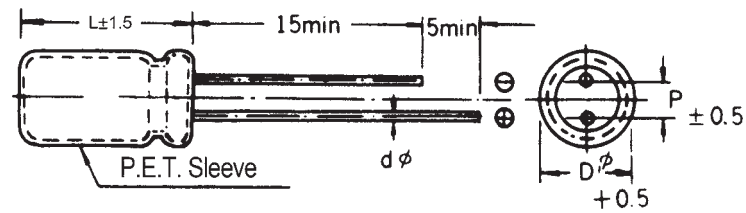

φD	8	10	12	13	14	16	18	20
φd	0.6	0.6	0.8	0.8	0.8	0.8	0.8	0.8
F	3.5	5		7.5				

Please check with us about individual sizes and dimensions.

LR Series Snap-in Type 85°C

Features

- ◆ Snap-in design for audio equipment.
- ◆ Aluminum case designed explosion-proof vent. Non solvent-proof type
- ◆ RoHS Compliant



For Audio Equipment

Specifications

Item	Performance Characteristics																																
Operating Temperature Range	-40~+85°C																																
Rated voltage Range	16 to 100 VDC																																
Capacitance Range	680~33000 µF																																
Capacitance Tolerance	±20%(120Hz,+20°C)																																
Leakage Current (+20°C,max.)	$I \leq 3 \sqrt{CV}$ (µA) After 5 minute with rated working voltage applied.																																
Dissipation Factor (tan δ , at 20°C , 120Hz)	Less than the value under table(%)																																
	<table border="1"> <thead> <tr> <th>µ F/Vdc</th> <th>16</th> <th>25</th> <th>35</th> <th>50</th> <th>63</th> <th>80</th> <th>100</th> </tr> </thead> <tbody> <tr> <td>≤8200</td> <td>35</td> <td>30</td> <td>25</td> <td>20</td> <td>20</td> <td>15</td> <td>15</td> </tr> <tr> <td>10000 to 22000</td> <td>40</td> <td>35</td> <td>30</td> <td>30</td> <td>25</td> <td>15</td> <td>-</td> </tr> <tr> <td>≥27000</td> <td>40</td> <td>35</td> <td>35</td> <td>30</td> <td>25</td> <td>-</td> <td>-</td> </tr> </tbody> </table>	µ F/Vdc	16	25	35	50	63	80	100	≤8200	35	30	25	20	20	15	15	10000 to 22000	40	35	30	30	25	15	-	≥27000	40	35	35	30	25	-	-
	µ F/Vdc	16	25	35	50	63	80	100																									
	≤8200	35	30	25	20	20	15	15																									
10000 to 22000	40	35	30	30	25	15	-																										
≥27000	40	35	35	30	25	-	-																										
Low Temperature Characteristics (at 120Hz)	Impedance ratio max																																
	<table border="1"> <thead> <tr> <th>Rated voltage(V)</th> <th>16</th> <th>25</th> <th>35</th> <th>50</th> <th>63</th> <th>100</th> </tr> </thead> <tbody> <tr> <td>Z - 25°C / Z+20°C</td> <td>5</td> <td>4</td> <td>4</td> <td>4</td> <td>4</td> <td>4</td> </tr> <tr> <td>Z - 40°C / Z+20°C</td> <td>15</td> <td>15</td> <td>12</td> <td>12</td> <td>12</td> <td>12</td> </tr> </tbody> </table>	Rated voltage(V)	16	25	35	50	63	100	Z - 25°C / Z+20°C	5	4	4	4	4	4	Z - 40°C / Z+20°C	15	15	12	12	12	12											
	Rated voltage(V)	16	25	35	50	63	100																										
Z - 25°C / Z+20°C	5	4	4	4	4	4																											
Z - 40°C / Z+20°C	15	15	12	12	12	12																											
Endurance	Test condition Duration time :2000 Hrs Ambient temperature :+85°C Applied voltage :Rated DC working voltage After test requirement at +20°C Capacitance change : ≤ ±25% of the initial measured value Dissipation factor : ≤200% of the initial specified value Leakage current : ≤The initial specified value																																
Shelf Life	Test condition Duration time :1000 Hrs Ambient temperature :+85°C Applied voltage :None After test requirement at +20°C:Same limits as Endurance. Pre-treatment for measurements shall be conducted after application of DC working voltage for 30 minutes.																																

Multiplier for Ripple Current vs. Frequency

CAP(µF)\Frequency(Hz)	50(60)	120	1K	10K	100K
CAP ≤ 100	0.80	1	1.36	1.48	1.53
100 < CAP ≤ 1000	0.80	1	1.25	1.35	1.38
1000 < CAP	0.80	1	1.17	1.25	1.28

Diagram of Dimensions:(unit:mm)

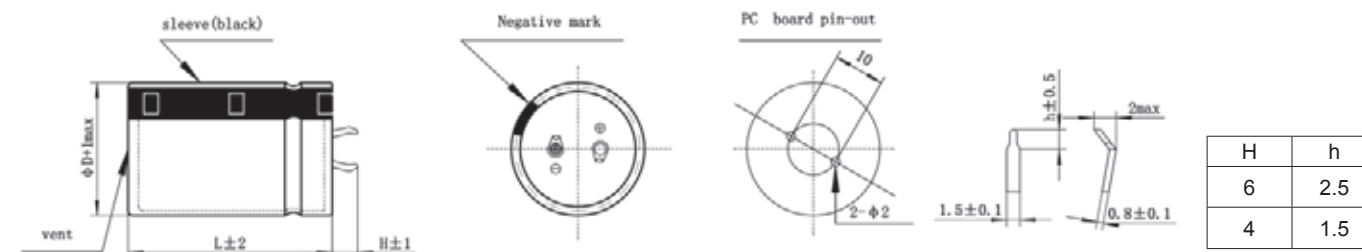

Case Size

WV (Vdc)	Cap (uF)	Size (mm)	Rated Ripple current (mA _{rms} /85°C /120Hz)
16	1200	22x20	0.95
16	1500	25x20	1.10
16	1800	22x20	1.20
16	2200	30x20	1.35
16	2700	25x20	1.75
16	3300	22x20	1.50
16	3300	25x20	2.00
16	3300	35x20	1.95
16	3900	22x20	2.30
16	3900	25x20	1.55
16	3900	25x20	2.35
16	3900	30x20	2.35
16	4700	22x20	1.35
16	4700	22x20	1.75
16	4700	22x20	2.75
16	4700	25x20	2.70
16	4700	30x20	2.70
16	4700	35x20	2.60
16	5600	25x20	2.90
16	5600	30x20	1.85
16	5600	30x20	2.90
16	6800	22x20	2.20
16	6800	25x20	1.70
16	6800	25x20	2.15
16	6800	25x20	3.20
16	6800	30x20	3.20
16	6800	35x20	3.15
16	8200	22x20	1.90
16	8200	22x20	2.40
16	8200	25x20	2.30
16	8200	30x20	3.35
16	8200	35x20	2.25
16	8200	35x20	3.30
16	10000	22x20	2.05
16	10000	22x20	2.65
16	10000	25x20	2.00
16	10000	25x20	2.45
16	10000	30x20	2.10
16	10000	30x20	2.50
16	10000	35x20	3.50
16	12000	22x20	2.20
16	12000	22x20	2.75
16	12000	25x20	2.15
16	12000	25x20	2.75
16	12000	30x20	2.72
16	12000	35x20	2.10
16	12000	35x20	3.50
16	12000	35x20	3.70
16	15000	22x20	2.50
16	15000	25x20	2.40
16	15000	25x20	3.10
16	15000	30x20	2.50
16	15000	30x20	3.10
16	18000	22x20	2.80
16	18000	25x20	2.60
16	18000	25x20	3.50
16	18000	30x20	2.65
16	18000	30x20	3.40
16	18000	35x20	3.45
16	22000	25x20	2.95

WV (Vdc)	Cap (uF)	Size (mm)	Rated Ripple current (mA _{rms} /85°C /120Hz)
16	22000	30x20	2.90
16	22000	30x20	3.80
16	22000	35x20	2.90
16	22000	35x20	3.80
16	27000	25x20	3.40
16	27000	30x20	3.25
16	27000	30x20	4.25
16	27000	35x20	3.35
16	27000	35x20	4.25
16	33000	30x20	3.70
16	33000	35x20	3.65
16	33000	35x20	4.50
25	820	22x20	0.75
25	1000	25x20	0.95
25	1500	30x20	1.30
25	1800	25x20	1.55
25	2200	22x20	1.85
25	2200	25x20	1.50
25	2200	25x20	1.80
25	2200	30x20	1.80
25	2200	35x20	1.75
25	2700	22x20	1.70
25	2700	22x20	2.20
25	2700	25x20	2.15
25	3300	22x20	1.50
25	3300	22x20	1.80
25	3300	22x20	2.50
25	3300	25x20	2.45
25	3300	30x20	1.85
25	3300	30x20	2.40
25	3300	35x20	2.45
25	3900	25x20	1.55
25	3900	25x20	1.10
25	3900	25x20	2.80
25	3900	30x20	2.80
25	4700	22x20	1.70
25	4700	22x20	2.30
25	4700	25x20	2.25
25	4700	30x20	3.25
25	4700	35x20	2.20
25	4700	35x20	3.15
25	5600	22x20	2.50
25	5600	25x20	2.40
25	5600	30x20	1.85
25	5600	30x20	2.50
25	5600	30x20	3.50
25	5600	35x20	3.50
25	6800	22x20	2.20
25	6800	22x20	2.65
25	6800	25x20	2.15
25	6800	25x20	2.65
25	6800	30x20	2.65
25	6800	35x20	3.80
25	8200	22x20	2.35
25	8200	25x20	2.30
25	8200	25x20	2.90
25	8200	30x20	2.85
25	8200	35x20	2.25
25	8200	35x20	3.05
25	8200	35x20	4.00

WV (Vdc)	Cap (uF)	Size (mm)	Rated Ripple current (mArms/85°C /120Hz)
25	10000	22x20	2.65
25	10000	25x20	2.50
25	10000	25x20	3.30
25	10000	30x20	2.65
25	10000	30x20	3.30
25	10000	35x20	3.30
25	12000	22x20	2.90
25	12000	25x20	2.75
25	12000	30x20	2.80
25	12000	30x20	3.55
25	12000	35x20	2.65
25	12000	35x20	3.50
25	15000	25x20	3.15
25	15000	30x20	3.10
25	15000	30x20	4.15
25	15000	35x20	4.00
25	18000	25x20	3.55
25	18000	30x20	3.40
25	18000	35x20	3.50
25	18000	35x20	4.45
25	22000	30x20	3.85
25	22000	35x20	3.85
25	27000	35x20	4.30
25	33000	35x20	4.85
35	820	25x20	0.85
35	1000	22x20	1.00
35	1200	22x20	1.30
35	1200	22x20	1.45
35	1200	25x20	1.40
35	1200	30x20	1.40
35	1500	22x20	1.55
35	1500	25x20	1.55
35	1800	22x20	1.55
35	1800	22x20	1.45
35	1800	25x20	1.65
35	1800	30x20	1.75
35	1800	35x20	1.70
35	2200	22x20	1.95
35	2200	25x20	1.95
35	2200	30x20	1.95
35	2700	22x20	2.05
35	2700	25x20	2.00
35	2700	25x20	2.35
35	2700	30x20	2.05
35	2700	30x20	2.30
35	2700	35x20	2.30
35	3300	22x20	1.75
35	3300	22x20	2.25
35	3300	25x20	2.20
35	3300	25x20	2.70
35	3300	30x20	2.70
35	3300	35x20	2.65
35	3900	22x20	2.40
35	3900	25x20	2.30
35	3900	30x20	1.85
35	3900	30x20	2.40
35	3900	30x20	3.00
35	3900	35x20	2.50
35	3900	35x20	3.00
35	4700	22x20	2.20
35	4700	22x20	2.70
35	4700	25x20	2.15

WV (Vdc)	Cap (uF)	Size (mm)	Rated Ripple current (mArms/85°C /120Hz)
35	4700	30x20	2.55
35	4700	30x20	3.55
35	4700	35x20	3.55
35	5600	22x20	2.35
35	5600	22x20	3.00
35	5600	22x20	2.60
35	5600	25x20	2.25
35	5600	25x20	3.00
35	5600	35x20	2.25
35	5600	35x20	2.85
35	5600	35x20	3.80
35	6800	30x20	2.60
35	6800	30x20	3.30
35	6800	35x20	3.05
35	6800	35x20	4.15
35	8200	22x20	2.90
35	8200	25x20	2.70
35	8200	30x20	2.75
35	8200	30x20	3.60
35	8200	35x20	3.30
35	10000	25x20	3.05
35	10000	30x20	3.00
35	10000	30x20	3.80
35	10000	35x20	3.20
35	10000	35x20	3.70
35	12000	25x20	3.45
35	12000	30x20	3.30
35	12000	35x20	3.40
35	12000	35x20	4.10
35	12000	35x20	3.80
35	15000	30x20	3.80
35	15000	35x20	4.80
35	18000	30x20	4.30
35	18000	35x20	4.15
35	22000	35x20	4.70
50	680	22x20	1.00
50	820	22x20	1.00
50	820	22x20	1.25
50	820	25x20	1.35
50	1000	25x20	1.50
50	1500	22x20	1.55
50	1500	22x20	1.80
50	1500	22x20	2.20
50	1500	25x20	2.15
50	1500	30x20	1.80
50	1500	30x20	2.15
50	1800	22x20	2.45
50	1800	25x20	1.65
50	1800	25x20	2.15
50	1800	25x20	2.45
50	1800	35x20	2.40
50	2200	22x20	1.85
50	2200	22x20	2.35
50	2200	25x20	2.30
50	2200	25x20	2.65
50	2200	30x20	2.60
50	2200	35x20	2.60
50	2200	35x20	2.60
50	2700	22x20	2.45
50	2700	25x20	2.50
50	2700	30x20	2.60
50	2700	30x20	3.00

WV (Vdc)	Cap (uF)	Size (mm)	Rated Ripple current (mArms/85°C /120Hz)
50	2700	35x20	2.95
50	3300	22x20	2.20
50	3300	22x20	2.80
50	3300	25x20	2.80
50	3300	30x20	2.80
50	3300	30x20	3.30
50	3300	35x20	3.25
50	3900	22x20	2.45
50	3900	25x20	2.50
50	3900	25x20	3.00
50	3900	30x20	2.35
50	3900	30x20	3.00
50	3900	35x20	2.45
50	3900	35x20	3.15
50	3900	35x20	3.50
50	4700	22x20	2.60
50	4700	25x20	2.70
50	4700	25x20	3.40
50	4700	30x20	3.30
50	4700	35x20	3.35
50	4700	35x20	3.90
50	5600	22x20	2.90
50	5600	25x20	2.90
50	5600	30x20	3.00
50	5600	30x20	3.60
50	5600	35x20	2.85
50	5600	35x20	3.60
50	6800	25x20	3.30
50	6800	30x20	3.25
50	6800	30x20	4.10
50	6800	35x20	3.95
50	8200	30x20	3.55
50	8200	35x20	3.65
50	8200	35x20	4.40
50	10000	30x20	4.00
50	10000	35x20	4.00
50	10000	35x20	5.50
50	12000	35x20	4.35
50	15000	35x20	4.70
63	680	22x20	1.75
63	820	22x20	1.30
63	820	22x20	1.90
63	820	25x20	1.65
63	820	25x20	1.85
63	820	30x20	1.90
63	1000	22x20	1.85
63	1000	22x20	2.05
63	1000	25x20	2.00
63	1200	22x20	1.95
63	1200	22x20	2.25
63	1200	25x20	1.65
63	1200	25x20	1.90
63	1200	30x20	1.95
63	1200	30x20	2.20
63	1200	35x20	2.30
63	1500	22x20	1.90
63	1500	22x20	2.15
63	1500	22x20	2.60
63	1500	25x20	2.10
63	1500	25x20	2.65
63	1800	22x20	2.00
63	1800	22x20	2.35

WV (Vdc)	Cap (uF)	Size (mm)	Rated Ripple current (mArms/85°C /120Hz)
63	1800	22x20	2.90
63	1800	25x20	2.00
63	1800	25x20	2.90
63	1800	30x20	2.05
63	1800	30x20	2.35
63	1800	30x20	2.90
63	1800	35x20	2.45
63	1800	35x20	2.70
63	2200	22x20	2.20
63	2200	22x20	2.70
63	2200	25x20	2.15
63	2200	25x20	2.75
63	2200	25x20	3.25
63	2200	30x20	2.50
63	2200	30x20	3.20
63	2200	35x20	2.10
63	2700	22x20	2.45
63	2700	25x20	2.35
63	2700	25x20	2.80
63	2700	30x20	2.50
63	2700	30x20	2.75
63	2700	30x20	3.30
63	2700	35x20	2.95
63	2700	35x20	3.65
63	3300	22x20	2.80
63	3300	25x20	2.60
63	3300	25x20	3.20
63	3300	30x20	2.70
63	3300	30x20	3.20
63	3300	30x20	3.80
63	3300	35x20	3.15
63	3300	35x20	4.00
63	3900	25x20	2.85
63	3900	30x20	2.85
63	3900	30x20	3.35
63	3900	35x20	3.35
63	3900	35x20	4.30
63	4700	25x20	3.20
63	4700	30x20	3.10
63	4700	30x20	3.80
63	4700	35x20	3.20
63	4700	35x20	4.50
63	5600	30x20	3.45
63	5600	35x20	3.40
63	5600	35x20	4.35
63	6800	30x20	3.90
63	6800	35x20	3.75
63	6800	35x20	4.60
63	8200	35x20	4.20
63	10000	35x20	4.80
80	680	22x20	2.25
80	680	25x20	2.15
80	820	22x20	2.05
80	820	22x20	2.45
80	820	25x20	1.65
80	820	25x20	2.00
80	820	25x20	2.35
80	820	30x20	2.05
80	820	30x20	2.40
80	820	35x20	2.55
80	1000	22x20	1.85
80	1000	22x20	2.20

WV (Vdc)	Cap (uF)	Size (mm)	Rated Ripple current (mA rms/85°C /120Hz)
80	1000	22x20	2.60
80	1000	25x20	2.15
80	1000	25x20	2.60
80	1000	30x20	2.60
80	1000	35x20	2.10
80	1200	22x20	2.45
80	1200	22x20	1.95
80	1200	25x20	2.30
80	1200	25x20	2.85
80	1200	25x20	1.90
80	1200	30x20	2.40
80	1200	30x20	2.80
80	1200	30x20	2.00
80	1200	35x20	2.95
80	1500	22x20	2.15
80	1500	22x20	2.60
80	1500	25x20	2.10
80	1500	25x20	2.65
80	1500	25x20	3.30
80	1500	30x20	2.65
80	1500	30x20	3.20
80	1500	35x20	3.25
80	1800	22x20	2.35
80	1800	22x20	2.70
80	1800	25x20	2.85
80	1800	30x20	2.40
80	1800	30x20	2.85
80	1800	30x20	3.55
80	1800	35x20	2.50
80	1800	35x20	3.00
80	1800	35x20	3.50
80	2200	25x20	2.75
80	2200	25x20	3.25
80	2200	30x20	2.55
80	2200	30x20	3.15
80	2200	30x20	4.05
80	2200	35x20	3.25
80	2200	35x20	3.90
80	2700	30x20	2.80
80	2700	30x20	3.60
80	2700	35x20	3.00
80	2700	35x20	3.55
80	2700	35x20	4.45
80	3300	25x20	3.25
80	3300	30x20	3.15
80	3300	30x20	4.10
80	3300	35x20	3.20
80	3300	35x20	3.95
80	3300	35x20	5.05
80	3900	30x20	3.45
80	3900	35x20	3.40
80	3900	35x20	4.35
80	4700	30x20	3.85
80	4700	35x20	3.75
80	4700	35x20	4.85
80	5600	35x20	4.10
80	6800	35x20	4.65

WV (Vdc)	Cap (uF)	Size (mm)	Rated Ripple current (mA rms/85°C /120Hz)
100	680	22x20	1.75
100	680	22x20	2.15
100	680	22x20	2.65
100	680	25x20	2.10
100	680	25x20	2.70
100	820	22x20	1.85
100	820	22x20	2.40
100	820	22x20	3.00
100	820	25x20	1.80
100	820	25x20	3.00
100	820	30x20	1.90
100	820	30x25	2.35
100	820	35x20	2.45
100	820	35x25	2.85
100	1000	22x45	2.70
100	1000	25x35	2.35
100	1000	25x40	3.10
100	1000	25x50	2.35
100	1000	30x30	3.00
100	1000	30x35	3.30
100	1000	35x30	3.05
100	1200	22x40	2.20
100	1200	22x50	3.00
100	1200	25x30	2.75
100	1200	30x25	2.20
100	1200	30x30	3.05
100	1200	30x40	3.60
100	1200	35x20	2.30
100	1200	35x25	2.90
100	1200	35x35	3.30
100	1500	22x45	2.55
100	1500	25x35	3.60
100	1500	25x50	3.20
100	1500	30x35	3.40
100	1500	30x50	3.90
100	1500	35x30	3.40
100	1500	35x40	3.95
100	1800	22x50	2.85
100	1800	25x40	2.85
100	1800	30x30	2.90
100	1800	30x40	3.70
100	1800	35x25	2.75
100	1800	35x35	3.40
100	1800	35x45	4.15
100	2200	25x45	3.20
100	2200	30x35	3.20
100	2200	30x50	3.95
100	2200	35x30	3.00
100	2200	35x40	3.80
100	2200	35x50	4.75
100	2700	30x40	3.55
100	2700	35x35	3.25
100	2700	35x45	4.30
100	3300	30x50	3.75
100	3300	35x50	4.95
100	3900	35x40	4.30
100	4700	35x50	4.50

LP Series 85°C

Features

Standard capacitors

Applications

- ◆ Switch-mode power supplies in industrial and entertainment electronics
- ◆ Uninterruptible power supplies

Features

- ◆ High reliability
- ◆ Long useful life
- ◆ High ripple current capability
- ◆ Aluminum case designed explosion-proof vent
- ◆ RoHS-compatible

Construction

- ◆ Charge-discharge proof, polar
- ◆ Aluminum case with insulating sleeve
- ◆ Aluminum case designed explosion-proof vent
- ◆ Snap-in solder pins to hold component in place on PC-board



Specifications

Item	Performance Characteristics											
Operating Temperature Range	-40 to +85°C	-25 to +85°C										
Rated voltage V_R	6.3 to 450 V DC	500 to 600 V DC										
Surge voltage V_S	$V_R \leq 315V$ 1.15 V_R $V_R > 315V$ 1.10 V_R											
Rated capacitance C_R	22 to 100000 μF											
Capacitance tolerance	$\pm 20\%$ (120Hz,+20°C)											
Leakage Current I_{leak} (+20°C,max.)	$I \leq 3 \sqrt{CV}$ (μA) After 5 minutes with rated working voltage applied											
Dissipation Factor ($\tan \delta$, at 20°C, 120Hz)	Less than the value under table(%)											
	$\mu F/Vdc$	6.3	10	16	25	35	50	63	80	100	160~420	450~600
	≤ 8200	-	35	35	30	25	20	20	15	15	15	20
	10000 to 22000	55	40	40	35	30	30	25	15	-	-	-
≥ 27000	60	50	40	35	35	30	25	-	-	-	-	
Self-inductance ESL	approx. 20 nH											
Useful life 85°C; $V_R, I_{AC,R}$ 85°C; $V_R, I_{AC,R}$	$V_R \leq 100V$:	Requirements:										
	>3000 h	$V_R \leq 100V$ DC/C $\leq \pm 30\%$ of initial value ESR ≤ 3 times initial specified limit $I_{leak} \leq$ initial specified limit					$V_R > 100V$ DC/C $\leq \pm 20\%$ of initial value ESR ≤ 2 times initial specified limit $I_{leak} \leq$ initial specified limit					
Voltage Endurance test 85°C; V_R	2000 h	Post test requirements:										
		$V_R \leq 100V$ DC/C $\leq \pm 15\%$ of initial value ESR ≤ 1.3 times initial specified limit $I_{leak} \leq$ initial specified limit					$V_R > 100V$ DC/C $\leq \pm 10\%$ of initial value ESR ≤ 1.3 times initial specified limit $I_{leak} \leq$ initial specified limit					
Shelf Life 85°C	1000 h	Post test requirements:										
		$V_R \leq 100V$ DC/C $\leq \pm 15\%$ of initial value ESR ≤ 1.3 times initial specified limit $I_{leak} \leq$ initial specified limit					$V_R > 100V$ DC/C $\leq \pm 10\%$ of initial value ESR ≤ 1.3 times initial specified limit $I_{leak} \leq$ initial specified limit					
Vibration Resistance test	To IEC 60068-2-6, test Fc: Displacement amplitude 0.75 mm, frequency range 10 ... 55 Hz, acceleration max. 10 g, duration 3x2 h. Capacitor mounted by its body which is rigidly clamped to the work surface.											
Characteristics at low temperature	Max. impedance ratio at 120 Hz											
	$V_R(V)$	6.3	10	16	25	35~100	160~250	315~450	500~600			
	$Z_{-25^\circ C} / Z_{20^\circ C}$	5	5	5	4	4	4	8	8			
$Z_{-40^\circ C} / Z_{20^\circ C}$	15	15	15	15	12	7	10	-				
Sectional specification	IEC 60384-4 and JIS-C-5101											

Multiplier for Ripple Current vs. Frequency

$V_R(V)/$ Frequency(Hz)	50(60)	120	300	1K	10K	50K-100K
$10 \leq V_R \leq 100$	0.88	1	1.07	1.15	1.15	1.15
$160 \leq V_R \leq 250$	0.81	1	1.17	1.32	1.45	1.5
$315 \leq V_R \leq 600$	0.77	1	1.16	1.30	1.41	1.43

Dimensional drawings

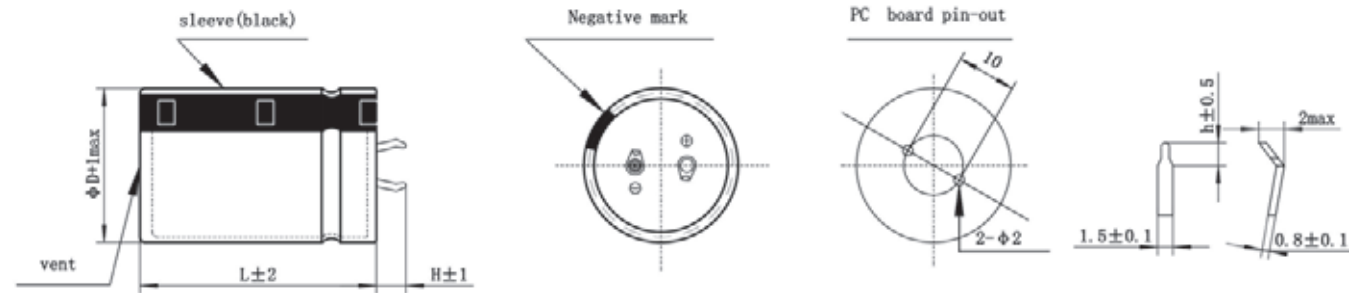

Standard snap-in terminals: length(6.0±1)mm
 Also available with length of(4.0±1)mm

H	h
6	2.5
4	1.5

Packing

Capacitor diameter D(mm)	Length L(mm)	Terminal length H(mm)	Each carton packing Qty units(pcs.)	Box/carton units(pcs.)	Each box packing Qty units(pcs.)
20	all	/	720	6	120
22	< 55	/	600	6	100
22	≥ 55	/	400	4	100
25	< 65	/	500	5	100
25	≥ 65	/	400	4	100
30	≤ 36	< 6(L=35、36)	400	8	50
30	35 ≤ L ≤ 65	≥ 6(L=35、36)	300	6	50
30	> 65	/	200	4	50
35	≤ 25	/	400	8	50
35	25 < L < 45	/	300	6	50
35	45 ≤ L ≤ 85	/	200	4	50
35	> 85	/	100	2	50
40	35	< 6	200	5	40
40	35	≥ 6	160	4	40
40	40 ≤ L ≤ 45	/	160	4	40
40	45 < L ≤ 75	/	120	3	40
40	> 75	/	80	2	40
45	40 ≤ L ≤ 65	/	140	4	35
45	65 < L ≤ 100	/	70	2	35

Packing of snap-in



Case Size

WV (Vdc)	Cap (uF)	Size (mm)	Rated Ripple current (Arms/85°C /120Hz)	Typ. ESR 20°C 120Hz (mΩ)	MAX ESR 20°C 120Hz (mΩ)
6.3	15000	22x25	2.50	37	49
6.3	18000	22x30	2.70	31	41
6.3	18000	25x25	2.71	31	41
6.3	22000	22x30	3.10	26	33
6.3	22000	25x25	3.12	26	33
6.3	27000	22x35	3.50	23	29
6.3	27000	25x30	3.55	23	29
6.3	27000	30x25	3.60	23	29
6.3	33000	22x40	3.58	19	24
6.3	33000	25x35	4.00	19	24
6.3	33000	30x25	4.00	19	24
6.3	39000	22x50	4.60	16	20
6.3	39000	25x40	4.50	16	20
6.3	39000	30x30	4.50	16	20
6.3	39000	35x25	4.55	16	20
6.3	47000	25x45	5.10	13	17
6.3	47000	30x35	5.10	13	17
6.3	47000	35x30	5.12	13	17
6.3	56000	25x50	5.75	11	14
6.3	56000	30x40	5.80	11	14
6.3	56000	35x30	5.80	11	14
6.3	68000	30x45	6.50	9	12
6.3	68000	35x35	6.50	9	12
6.3	82000	30x50	7.35	8	10
6.3	82000	35x40	7.38	8	10
6.3	100000	35x45	8.35	6	8
10	4700	22x20	2.40	76	99
10	6800	22x25	2.84	53	68
10	8200	22x25	2.90	44	57
10	10000	22x25	2.95	36	46
10	10000	25x25	3.06	36	46
10	12000	22x25	3.32	34	44
10	12000	25x25	3.43	34	44
10	15000	22x30	3.40	27	35
10	15000	25x25	3.85	27	35
10	18000	22x35	4.30	23	29
10	18000	25x25	4.20	23	29
10	22000	22x40	4.80	19	24
10	22000	25x30	4.75	19	24
10	22000	30x25	4.83	19	24
10	27000	22x45	5.30	19	25
10	27000	25x35	5.10	19	25
10	27000	30x30	5.32	19	25
10	33000	22x50	5.50	15	20
10	33000	25x40	5.50	15	20
10	33000	30x30	5.50	15	20
10	33000	35x25	5.60	15	20
10	39000	25x45	6.31	13	17
10	39000	30x35	6.25	13	17
10	39000	35x30	6.39	13	17
10	47000	25x50	6.60	11	14
10	47000	30x40	6.70	11	14
10	47000	35x30	6.72	11	14
10	56000	30x45	6.80	9	12
10	56000	35x35	6.90	9	12
10	68000	30x50	7.60	8	10
10	68000	35x40	7.80	8	10
10	82000	35x50	8.50	6	8

WV (Vdc)	Cap (uF)	Size (mm)	Rated Ripple current (Arms/85°C /120Hz)	Typ. ESR 20°C 120Hz (mΩ)	MAX ESR 20°C 120Hz (mΩ)
16	4700	22x20	2.40	76	99
16	6800	22x25	2.84	53	68
16	8200	22x25	2.90	44	57
16	10000	22x25	3.06	36	46
16	10000	25x25	3.50	36	46
16	12000	22x30	3.43	34	44
16	12000	25x25	3.45	34	44
16	15000	22x35	3.94	27	35
16	15000	25x30	4.20	27	35
16	15000	30x25	3.95	27	35
16	18000	22x40	4.50	23	29
16	18000	25x30	4.34	23	29
16	22000	22x45	4.80	19	24
16	22000	25x35	4.75	19	24
16	22000	25x40	5.10	19	24
16	22000	30x30	5.20	19	24
16	27000	25x45	6.30	15	20
16	27000	30x35	6.50	15	20
16	27000	35x25	5.90	15	20
16	33000	25x50	6.50	12	16
16	33000	30x40	6.60	12	16
16	33000	35x30	6.80	12	16
16	39000	25x45	5.80	10	14
16	39000	30x45	7.05	10	14
16	39000	35x35	7.10	10	14
16	47000	25x50	6.20	9	11
16	47000	30x50	7.65	9	11
16	47000	35x40	7.75	9	11
16	56000	30x50	7.80	7	10
16	56000	35x45	8.10	7	10
16	56000	35x50	8.20	7	10
16	68000	35x50	8.55	6	8
25	4700	22x25	2.64	65	85
25	5600	22x25	2.72	55	71
25	6800	22x30	3.10	45	59
25	6800	25x25	3.20	45	59
25	8200	22x30	3.15	37	49
25	8200	25x25	3.25	37	49
25	10000	22x35	3.43	31	40
25	10000	25x30	3.90	31	40
25	10000	30x25	3.43	31	40
25	12000	22x40	3.84	30	39
25	12000	25x35	4.37	30	39
25	12000	30x30	4.40	30	39
25	15000	22x50	4.94	24	31
25	15000	25x40	4.80	24	31
25	15000	30x30	4.85	24	31
25	18000	25x45	5.50	20	26
25	18000	30x35	5.60	20	26
25	22000	30x35	5.40	16	21
25	22000	35x30	5.50	16	21
25	27000	30x45	6.25	13	17
25	27000	35x35	6.30	13	17
25	33000	30x50	6.85	11	14
25	33000	35x40	6.90	11	14
25	39000	35x45	7.36	9	12
25	47000	35x50	8.62	8	10
35	2200	22x25	2.18	120	150

WV (Vdc)	Cap (uF)	Size (mm)	Rated Ripple current (Arms/85°C /120Hz)	Typ. ESR 20°C 120Hz (mΩ)	MAX ESR 20°C 120Hz (mΩ)
35	3300	22x25	2.46	77	100
35	3900	22x25	2.50	65	85
35	4700	22x30	3.10	54	71
35	4700	25x25	3.10	54	71
35	5600	22x30	2.72	46	59
35	5600	25x25	2.80	46	59
35	6800	22x35	3.60	38	49
35	6800	25x30	3.70	38	49
35	6800	30x25	3.80	38	49
35	8200	22x40	3.90	31	40
35	8200	25x35	3.95	31	40
35	8200	30x30	4.10	31	40
35	10000	22x45	4.15	26	33
35	10000	25x40	4.68	26	33
35	10000	30x30	4.58	26	33
35	12000	22x50	4.70	26	33
35	12000	25x45	5.10	26	33
35	12000	30x35	5.15	26	33
35	12000	35x30	5.25	26	33
35	15000	25x50	5.30	20	27
35	15000	30x40	5.72	20	27
35	15000	35x30	5.72	20	27
35	18000	30x45	6.10	17	22
35	18000	35x35	6.10	17	22
35	22000	30x50	6.50	14	18
35	22000	35x40	6.55	14	18
35	27000	35x45	6.80	13	17
35	33000	35x50	7.20	11	14
50	1000	22x20	1.20	210	270
50	1500	22x25	1.44	140	180
50	2200	22x25	2.04	92	120
50	2700	22x30	2.30	76	98
50	3300	22x30	2.90	62	80
50	3300	25x25	3.10	62	80
50	3900	22x30	2.95	52	68
50	3900	25x25	3.15	52	68
50	4700	22x35	3.30	43	56
50	4700	25x30	3.40	43	56
50	4700	30x25	3.50	43	56
50	5600	22x40	3.60	36	47
50	5600	25x40	3.75	36	47
50	5600	30x30	3.80	36	47
50	5600	35x25	3.85	36	47
50	6800	22x50	4.20	30	39
50	6800	25x40	4.15	30	39
50	6800	30x30	4.20	30	39
50	8200	25x45	4.75	25	32
50	8200	30x35	4.80	25	32
50	8200	35x30	4.90	25	32
50	10000	25x50	5.20	20	27
50	10000	30x40	5.50	20	27
50	10000	35x30	5.20	20	27
50	12000	30x45	5.80	26	33
50	12000	35x35	6.10	26	33
50	15000	30x50	6.50	20	27
50	15000	35x40	6.80	20	27
50	18000	30x50	7.10	17	22
50	18000	35x45	7.20	17	22
50	22000	35x50	7.80	14	18
63	1000	22x20	1.50	210	270

WV (Vdc)	Cap (uF)	Size (mm)	Rated Ripple current (Arms/85°C /120Hz)	Typ. ESR 20°C 120Hz (mΩ)	MAX ESR 20°C 120Hz (mΩ)
63	1500	22x25	1.68	140	180
63	1800	22x25	2.20	120	150
63	2200	22x30	2.52	92	120
63	2200	25x25	2.55	92	120
63	2700	22x35	2.82	76	98
63	2700	25x30	2.90	76	98
63	3300	22x35	3.15	62	80
63	3300	25x30	3.25	62	80
63	3300	30x25	3.35	62	80
63	3900	22x40	3.65	52	68
63	3900	25x35	3.75	52	68
63	3900	30x30	3.80	52	68
63	4700	22x45	3.40	43	56
63	4700	25x35	3.30	43	56
63	4700	30x30	3.45	43	56
63	4700	35x25	3.50	43	56
63	5600	25x45	4.65	36	47
63	5600	30x35	4.70	36	47
63	5600	35x30	4.80	36	47
63	6800	25x50	5.30	30	39
63	6800	30x40	5.30	30	39
63	6800	35x30	5.40	30	39
63	8200	30x40	5.45	25	32
63	8200	35x35	5.72	25	32
63	10000	30x50	6.35	20	27
63	10000	35x40	6.50	20	27
63	12000	35x45	6.60	21	28
63	15000	35x50	6.80	17	22
80	680	22x20	1.25	220	290
80	1000	22x25	1.62	150	200
80	1200	22x25	1.65	130	170
80	1500	22x30	2.50	100	130
80	1500	25x25	2.50	100	130
80	1800	22x30	2.92	85	110
80	1800	25x25	3.00	85	110
80	2200	22x35	3.25	70	90
80	2200	25x30	3.35	70	90
80	2200	30x25	3.40	70	90
80	2700	22x40	3.50	57	74
80	2700	25x35	3.60	57	74
80	2700	30x30	3.65	57	74
80	3300	22x45	3.70	46	60
80	3300	25x40	3.90	46	60
80	3300	30x30	3.90	46	60
80	3900	22x50	4.80	39	51
80	3900	25x45	4.90	39	51
80	3900	30x35	4.90	39	51
80	4700	25x50	5.40	33	42
80	4700	30x40	5.45	33	42
80	4700	35x30	5.50	33	42
80	5600	30x45	5.60	27	36
80	5600	35x35	5.65	27	36
80	6800	30x50	5.80	23	29
80	6800	35x40	5.85	23	29
80	8200	35x50	6.20	19	24
80	10000	35x50	6.65	15	20
80	12000	35x60	7.10	13	17
100	470	22x20	1.34	320	420
100	680	22x25	1.53	220	290
100	820	22x25	1.90	180	240

WV (Vdc)	Cap (uF)	Size (mm)	Rated Ripple current (Arms/85°C /120Hz)	Typ. ESR 20°C 120Hz (mΩ)	MAX ESR 20°C 120Hz (mΩ)
100	1000	22x25	2.00	150	200
100	1000	25x25	1.95	150	200
100	1200	22x30	2.40	130	170
100	1200	25x25	2.40	130	170
100	1500	22x35	2.85	100	130
100	1500	25x30	2.95	100	130
100	1500	30x25	3.10	100	130
100	1800	22x40	3.30	85	110
100	1800	25x35	3.50	85	110
100	1800	30x30	3.40	85	110
100	2700	22x50	3.73	57	74
100	2700	25x40	3.75	57	74
100	2700	30x35	4.00	57	74
100	2700	35x30	4.10	57	74
100	3300	25x50	4.15	46	60
100	3300	30x35	3.90	46	60
100	3300	30x40	4.20	46	60
100	3300	35x30	4.20	46	60
100	3900	30x40	4.50	39	51
100	3900	30x45	4.60	39	51
100	3900	35x30	4.52	39	51
100	3900	35x35	4.70	39	51
100	4700	30x45	5.10	33	42
100	4700	30x50	5.86	33	42
100	4700	35x35	5.10	33	42
100	4700	35x40	5.90	33	42
100	5600	30x50	5.80	27	36
100	5600	35x40	5.90	27	36
100	5600	35x45	6.34	27	36
100	6800	35x45	6.60	23	29
100	6800	35x50	6.80	23	29
100	8200	35x60	7.30	19	24
160	180	22x20	1.12	650	1110
160	220	22x20	1.16	530	900
160	220	22x25	1.20	530	900
160	270	22x25	1.35	440	740
160	330	22x25	1.39	350	600
160	330	22x30	1.44	350	600
160	390	25x25	1.66	300	510
160	470	22x30	1.76	250	420
160	470	25x25	1.78	250	420
160	560	22x25	2.30	210	360
160	560	22x30	2.40	210	360
160	680	22x30	2.50	170	290
160	680	25x30	2.55	170	290
160	820	22x35	2.75	140	240
160	820	25x25	2.53	140	240
160	1000	22x40	3.00	120	200
160	1000	25x30	3.00	120	200
160	1200	22x45	3.26	100	170
160	1200	25x35	3.25	100	170
160	1200	30x25	3.05	100	170
160	1500	22x50	3.73	76	130
160	1500	25x40	3.73	76	130
160	1500	30x30	3.73	76	130
160	1500	35x25	3.50	76	130
160	1800	25x45	4.20	65	110
160	1800	30x35	4.20	65	110
160	1800	35x30	4.30	65	110
160	2200	30x40	4.78	53	90

WV (Vdc)	Cap (uF)	Size (mm)	Rated Ripple current (Arms/85°C /120Hz)	Typ. ESR 20°C 120Hz (mΩ)	MAX ESR 20°C 120Hz (mΩ)
160	2200	35x35	4.85	53	90
160	2700	30x45	4.90	43	74
160	2700	35x40	5.45	43	74
160	3300	35x45	5.75	35	60
160	3900	35x50	6.00	30	51
180	330	22x25	1.43	350	600
180	390	22x30	1.62	300	510
180	470	22x25	2.09	250	420
180	470	22x30	1.80	250	420
180	470	25x25	2.00	250	420
180	560	22x30	2.10	210	360
180	560	22x35	2.10	210	360
180	560	25x30	2.15	210	360
180	680	22x30	2.50	170	290
180	680	22x40	2.60	170	290
180	680	25x25	2.51	170	290
180	680	30x25	2.62	170	290
180	820	22x35	2.76	140	240
180	820	25x30	2.80	140	240
180	820	30x30	2.57	140	240
180	1000	22x45	3.00	120	200
180	1000	25x35	3.00	120	200
180	1000	30x25	3.00	120	200
180	1200	22x50	3.31	100	170
180	1200	25x40	3.31	100	170
180	1200	30x30	3.30	100	170
180	1200	35x25	3.40	100	170
180	1500	25x45	3.83	76	130
180	1500	30x35	3.85	76	130
180	1500	35x30	3.83	76	130
180	1800	25x50	4.32	65	110
180	1800	30x40	4.32	65	110
180	1800	35x30	4.35	65	110
180	2200	30x45	4.92	53	90
180	2200	35x40	5.12	53	90
180	2700	35x45	5.52	43	74
200	150	22x20	0.96	780	1330
200	180	22x20	0.98	650	1110
200	180	22x25	1.00	650	1110
200	220	20x25	1.20	530	900
200	220	22x25	1.36	530	900
200	220	22x30	1.38	530	900
200	270	22x25	1.46	440	740
200	270	22x30	1.50	440	740
200	330	20x35	1.60	350	600
200	330	22x25	1.70	350	600
200	330	22x30	1.89	350	600
200	330	25x25	1.92	350	600
200	390	22x25	1.75	300	510
200	390	22x30	1.92	300	510
200	390	25x25	1.95	300	510
200	390	25x30	1.95	300	510
200	470	22x25	1.90	250	420
200	470	22x30	2.09	250	420
200	470	25x25	2.01	250	420
200	470	25x30	2.23	250	420
200	560	22x30	2.44	210	360
200	560	22x35	2.50	210	360
200	560	25x25	2.43	210	360
200	560	25x30	2.50	210	360

WV (Vdc)	Cap (uF)	Size (mm)	Rated Ripple current (Arms/85°C /120Hz)	Typ. ESR 20°C 120Hz (mΩ)	MAX ESR 20°C 120Hz (mΩ)
200	680	22x35	2.68	170	290
200	680	22x45	2.90	170	290
200	680	25x30	2.80	170	290
200	680	25x35	2.98	170	290
200	680	30x25	2.40	170	290
200	820	22x40	2.93	140	240
200	820	22x45	3.10	140	240
200	820	25x30	2.93	140	240
200	820	25x35	3.00	140	240
200	820	30x25	2.95	140	240
200	820	30x30	3.10	140	240
200	1000	22x45	3.25	120	200
200	1000	22x50	3.32	120	200
200	1000	25x35	3.25	120	200
200	1000	30x30	3.32	120	200
200	1000	35x25	3.30	120	200
200	1200	22x50	3.50	100	170
200	1200	25x40	3.50	100	170
200	1200	30x30	3.50	100	170
200	1200	30x35	3.60	100	170
200	1500	25x50	4.10	76	130
200	1500	30x35	3.80	76	130
200	1500	35x30	3.87	76	130
200	1800	30x40	3.90	65	110
200	1800	30x45	4.40	65	110
200	1800	35x35	4.50	65	110
200	1800	35x45	5.84	65	110
200	2200	30x50	5.00	53	90
200	2200	35x40	4.92	53	90
200	2700	35x45	5.90	43	74
200	2700	35x50	6.00	43	74
200	3300	35x50	6.10	35	60
250	120	22x20	0.85	980	1660
250	150	22x20	0.90	780	1330
250	150	22x25	0.98	780	1330
250	180	22x25	1.05	650	1110
250	180	22x30	1.12	650	1110
250	220	22x25	1.26	530	900
250	270	22x25	1.41	440	740
250	270	22x30	1.60	440	740
250	330	22x30	1.77	350	600
250	330	25x25	1.78	350	600
250	390	22x30	2.00	300	510
250	390	25x25	2.00	300	510
250	470	22x35	2.12	250	420
250	470	25x30	2.11	250	420
250	470	30x30	2.38	250	420
250	560	22x40	2.26	210	360
250	560	25x30	2.26	210	360
250	560	25x35	2.32	210	360
250	560	30x25	2.26	210	360
250	680	22x45	2.81	170	290
250	680	25x35	2.59	170	290
250	680	30x30	2.51	170	290
250	820	22x50	2.98	150	250
250	820	25x40	2.98	140	240
250	820	30x30	2.78	140	240
250	820	35x25	2.78	140	240
250	1000	25x45	3.33	120	200
250	1000	25x50	3.54	120	200

WV (Vdc)	Cap (uF)	Size (mm)	Rated Ripple current (Arms/85°C /120Hz)	Typ. ESR 20°C 120Hz (mΩ)	MAX ESR 20°C 120Hz (mΩ)
250	1000	30x35	3.33	120	200
250	1000	35x30	3.33	120	200
250	1200	30x40	3.67	100	170
250	1200	35x35	3.80	100	170
250	1500	30x50	4.45	76	130
250	1500	35x40	4.45	76	130
250	1800	35x45	4.56	65	110
250	2200	35x50	4.76	53	90
315	180	25x25	1.32	650	1110
315	220	22x30	1.42	530	900
315	270	25x30	1.63	440	740
315	330	22x40	1.83	350	600
315	330	25x30	1.83	350	600
315	330	30x25	1.85	350	600
315	390	22x45	2.02	300	510
315	390	25x35	1.98	300	510
315	390	30x30	2.15	300	510
315	470	25x40	2.28	250	420
315	470	30x30	2.30	250	420
315	470	35x25	2.35	250	420
315	560	25x45	2.57	210	360
315	560	30x35	2.57	210	360
315	560	35x30	2.65	210	360
315	680	30x40	2.88	170	290
315	680	35x35	2.92	170	290
315	820	30x45	3.26	140	240
315	820	35x40	3.35	140	240
315	1000	30x50	3.63	120	200
315	1000	35x45	3.72	120	200
350	100	22x25	0.76	1170	1990
350	120	22x25	0.99	980	1660
350	120	25x25	1.02	980	1660
350	150	22x25	1.12	780	1330
350	180	22x30	1.22	650	1110
350	220	22x40	1.41	530	900
350	220	25x35	1.47	530	900
350	220	30x25	1.48	530	900
350	270	22x40	1.70	440	740
350	270	25x30	1.67	440	740
350	330	22x45	1.90	350	600
350	330	25x35	1.89	350	600
350	330	35x30	1.95	350	600
350	390	22x50	2.08	300	510
350	390	25x40	2.07	300	510
350	390	30x30	2.09	300	510
350	390	35x25	2.15	300	510
350	470	25x45	2.41	250	420
350	470	30x35	2.50	250	420
350	470	35x30	2.55	250	420
350	560	25x50	2.61	210	360
350	560	30x40	2.63	210	360
350	560	35x30	2.65	210	360
350	680	30x45	2.97	170	290
350	680	35x35	3.00	170	290
350	820	30x50	3.26	140	240
350	820	35x45	3.40	140	240
350	1000	35x50	3.55	120	200
385	82	22x25	0.75	1430	2430
385	100	22x30	0.85	1170	1990
385	120	22x30	0.95	980	1660

WV (Vdc)	Cap (uF)	Size (mm)	Rated Ripple current (Arms/85°C /120Hz)	Typ. ESR 20°C 120Hz (mΩ)	MAX ESR 20°C 120Hz (mΩ)
385	120	25x25	0.98	980	1660
385	150	22x35	1.12	780	1330
385	150	25x30	1.15	780	1330
385	180	22x40	1.21	650	1110
385	180	25x35	1.25	650	1110
385	180	30x25	1.31	650	1110
385	220	22x45	1.45	530	900
385	220	25x35	1.45	530	900
385	220	30x30	1.47	530	900
385	270	25x40	1.59	440	740
385	270	30x35	1.65	440	740
385	330	25x50	1.85	350	600
385	330	30x40	1.89	350	600
385	330	35x30	1.91	350	600
385	390	30x40	2.07	300	510
385	390	35x35	2.10	300	510
385	470	30x50	2.62	250	420
385	470	35x40	2.84	250	420
385	560	35x45	2.98	210	360
385	680	35x50	3.71	170	290
385	680	40x40	3.82	170	290
385	820	35x55	4.18	140	240
385	820	40x45	4.25	140	240
385	1000	35x65	4.95	120	200
385	1000	40x50	4.89	120	200
385	1000	45x40	4.85	120	200
385	1200	35x75	5.68	100	170
385	1200	40x60	5.55	100	170
385	1200	45x45	5.52	100	170
385	1500	35x90	6.71	76	130
385	1500	40x70	6.59	76	130
385	1500	45x55	6.55	76	130
385	1800	40x80	7.23	65	110
385	1800	45x60	7.12	65	110
385	2200	40x95	8.54	53	90
385	2200	45x75	8.31	53	90
385	2700	45x85	8.91	43	74
400	47	22x20	0.42	2490	4230
400	56	22x25	0.53	2090	3550
400	68	22x20	0.44	1720	2930
400	68	22x25	0.47	1720	2930
400	82	20x25	0.60	1430	2430
400	82	22x25	0.83	1430	2430
400	100	22x25	0.85	1170	1990
400	100	22x30	0.91	1170	1990
400	120	22x25	1.03	980	1660
400	150	22x25	1.15	780	1330
400	150	22x30	1.18	780	1330
400	150	25x30	1.22	780	1330
400	150	30x25	1.25	780	1330
400	180	22x30	1.50	650	1110
400	180	25x25	1.50	650	1110
400	180	30x25	1.53	650	1110
400	220	22x35	1.70	530	900
400	220	25x30	1.72	530	900
400	220	30x35	1.75	530	900
400	270	22x40	1.91	440	740
400	270	25x35	2.00	440	740
400	270	30x25	1.96	440	740
400	270	35x30	2.05	440	740

WV (Vdc)	Cap (uF)	Size (mm)	Rated Ripple current (Arms/85°C /120Hz)	Typ. ESR 20°C 120Hz (mΩ)	MAX ESR 20°C 120Hz (mΩ)
400	330	22x50	2.00	350	600
400	330	25x40	2.00	350	600
400	330	30x30	2.05	350	600
400	330	35x25	2.20	350	600
400	330	35x30	2.30	350	600
400	390	22x50	2.10	300	510
400	390	25x45	2.20	300	510
400	390	30x30	2.10	300	510
400	390	30x35	2.20	300	510
400	390	35x25	2.30	300	510
400	390	35x30	2.50	300	510
400	470	25x50	2.70	250	420
400	470	30x35	2.60	250	420
400	470	35x30	2.60	250	420
400	560	30x40	2.92	210	360
400	560	30x45	2.92	210	360
400	560	35x35	2.92	210	360
400	560	35x40	2.95	210	360
400	680	30x45	3.30	170	290
400	680	30x50	3.40	170	290
400	680	35x35	3.35	170	290
400	680	35x40	3.40	170	290
400	820	35x45	3.45	140	240
400	820	35x50	3.50	140	240
400	1000	35x50	3.94	120	200
400	1200	35x55	4.45	100	170
400	1200	35x80	5.60	100	170
400	1200	40x60	5.33	100	170
400	1200	45x50	5.20	100	170
400	1500	35x95	6.66	76	130
400	1500	40x75	6.32	76	130
400	1500	45x55	5.92	76	130
400	2200	45x80	7.90	53	90
400	2700	45x90	9.09	43	74
420	47	22x20	0.48	3320	5640
420	56	22x25	0.53	2790	4740
420	68	22x25	0.73	2290	3900
420	68	22x30	0.68	2290	3900
420	82	22x25	0.88	1900	3230
420	82	22x30	0.92	1900	3230
420	82	25x25	0.95	1900	3230
420	100	22x25	1.03	1560	2650
420	100	22x30	1.07	1560	2650
420	100	25x25	1.12	1560	2650
420	120	22x25	1.08	1300	2210
420	120	22x30	1.10	1300	2210
420	120	25x25	1.10	1300	2210
420	150	22x30	1.33	1040	1770
420	150	25x25	1.35	1040	1770
420	150	25x30	1.35	1040	1770
420	150	30x25	1.39	1040	1770
420	180	22x35	1.50	860	1470
420	180	25x30	1.50	860	1470
420	180	30x25	1.55	860	1470
420	220	22x40	1.78	710	1210
420	220	25x35	1.80	710	1210
420	220	30x25	1.83	710	1210
420	270	22x45	1.94	580	980
420	270	25x35	1.94	580	980
420	270	25x40	1.98	580	980

WV (Vdc)	Cap (uF)	Size (mm)	Rated Ripple current (Arms/85°C /120Hz)	Typ. ESR 20°C 120Hz (mΩ)	MAX ESR 20°C 120Hz (mΩ)
420	270	30x30	1.94	580	980
420	270	35x35	2.00	580	980
420	330	25x45	2.15	470	800
420	330	30x40	2.18	470	800
420	330	35x35	2.21	470	800
420	330	35x40	2.25	470	800
420	390	25x45	2.35	400	680
420	390	30x40	2.35	400	680
420	390	35x35	2.43	400	680
420	390	35x40	2.52	400	680
420	470	30x40	2.60	330	560
420	470	30x45	2.78	330	560
420	470	35x35	2.78	330	560
420	470	35x40	2.80	330	560
420	560	30x45	2.85	280	470
420	560	35x40	2.95	280	470
420	560	35x45	2.97	280	470
420	560	40x40	2.95	280	470
420	680	35x45	3.59	230	390
420	680	35x50	3.62	230	390
420	680	40x45	3.75	230	390
420	820	35x50	4.15	190	320
420	820	40x50	4.23	190	320
420	820	45x40	4.32	190	320
420	1000	35x75	5.01	160	270
420	1000	40x60	4.91	160	270
420	1000	45x45	4.78	160	270
420	1200	35x85	5.53	130	220
420	1200	40x70	5.68	130	220
420	1200	45x55	5.48	130	220
420	1500	40x80	6.38	110	180
420	1500	45x65	6.25	110	180
420	1800	40x95	7.51	88	150
420	1800	45x70	7.21	88	150
420	2200	45x85	7.88	71	120
450	22	22x20	0.30	7090	12060
450	47	22x20	0.50	3320	5640
450	56	22x25	0.60	2790	4740
450	68	22x25	0.73	2290	3900
450	68	22x30	0.75	2290	3900
450	82	22x25	0.85	1900	3230
450	82	25x25	0.90	1900	3230
450	100	22x30	0.95	1560	2650
450	100	25x25	0.98	1560	2650
450	120	22x30	1.10	1300	2210
450	120	25x25	1.15	1300	2210
450	150	22x30	1.39	1040	1770
450	150	22x35	1.43	1040	1770
450	150	25x25	1.43	1040	1770
450	150	30x25	1.45	1040	1770
450	150	30x30	1.47	1040	1770
450	180	22x35	1.35	860	1470
450	180	25x30	1.38	860	1470
450	180	25x35	1.41	860	1470
450	180	30x25	1.38	860	1470
450	220	22x40	1.56	710	1210
450	220	25x35	1.61	710	1210
450	220	25x40	1.65	710	1210
450	220	30x25	1.61	710	1210
450	220	30x30	1.65	710	1210

WV (Vdc)	Cap (uF)	Size (mm)	Rated Ripple current (Arms/85°C /120Hz)	Typ. ESR 20°C 120Hz (mΩ)	MAX ESR 20°C 120Hz (mΩ)
450	220	35x25	1.65	710	1210
450	270	22x45	1.90	580	980
450	270	25x40	1.92	580	980
450	270	25x45	1.86	580	980
450	270	30x30	1.88	580	980
450	270	35x25	1.84	580	980
450	270	35x35	1.92	580	980
450	330	25x45	2.10	470	800
450	330	30x35	1.98	470	800
450	330	30x40	2.10	470	800
450	330	35x25	2.00	470	800
450	330	35x30	2.10	470	800
450	390	25x50	2.30	400	680
450	390	30x35	2.20	400	680
450	390	30x40	2.30	400	680
450	390	35x30	2.60	400	680
450	390	35x40	2.54	400	680
450	470	30x40	2.55	330	560
450	470	30x45	2.58	330	560
450	470	35x35	2.58	330	560
450	470	35x40	2.60	330	560
450	470	35x45	2.62	330	560
450	470	40x40	2.65	330	560
450	560	30x50	2.83	280	470
450	560	35x40	2.85	280	470
450	560	35x45	2.88	280	470
450	560	40x45	3.27	280	470
450	680	30x55	3.52	230	390
450	680	35x45	3.52	230	390
450	680	40x50	3.71	230	390
450	680	45x40	3.71	230	390
450	820	35x50	3.75	190	320
450	820	35x70	4.31	190	320
450	820	40x55	4.30	190	320
450	820	45x45	4.14	190	320
450	1000	35x80	5.30	160	270
450	1000	40x60	4.71	160	270
450	1000	40x65	4.89	160	270
450	1000	45x50	4.71	160	270
450	1200	35x95	5.85	130	220
450	1200	40x75	5.55	130	220
450	1200	45x60	5.55	130	220
450	1500	40x90	6.56	110	180
450	1500	45x70	6.27	110	180
450	1800	45x80	7.12	88	150
450	2200	45x95	8.28	71	120
500	56	22x25	0.65	2790	4740
500	68	22x30	0.75	2290	3900
500	68	25x25	0.75	2290	3900
500	68	25x30	0.78	2290	3900
500	82	22x35	0.88	1900	3230
500	82	25x30	0.90	1900	3230
500	82	30x30	0.92	1900	3230
500	100	22x40	0.96	1560	2650
500	100	25x30	0.98	1560	2650
500	100	30x30	1.05	1560	2650
500	120	22x45	1.10	1300	2210
500	120	25x40	1.13	1300	2210
500	120	30x30	1.16	1300	2210
500	150	22x50	1.22	1040	1770

WV (Vdc)	Cap (uF)	Size (mm)	Rated Ripple current (Arms/85°C /120Hz)	Typ. ESR 20°C 120Hz (mΩ)	MAX ESR 20°C 120Hz (mΩ)
500	150	25x45	1.27	1040	1770
500	150	30x30	1.24	1040	1770
500	180	25x50	1.42	860	1470
500	180	30x35	1.40	860	1470
500	220	30x40	1.65	710	1210
500	220	35x40	1.68	710	1210
500	270	30x40	1.50	580	980
500	270	35x40	1.88	580	980
500	330	30x50	1.95	470	800
500	330	35x50	2.10	470	800
500	390	35x55	2.35	400	680
500	390	40x45	2.37	400	680
500	470	35x60	2.60	330	560
500	470	40x50	2.60	330	560
500	560	35x70	2.51	280	470
500	560	40x55	2.49	280	470
500	680	40x65	2.83	230	390
500	680	45x50	2.81	230	390
500	820	40x75	3.22	190	320
500	820	45x60	3.20	190	320
500	1000	40x85	3.66	160	270
500	1000	45x70	3.62	160	270
500	1200	45x80	4.15	130	220
500	1500	45x100	4.90	110	180
550	47	25x25	0.52	3320	5640
550	56	25x25	0.65	2790	4740
550	68	25x30	0.75	2290	3900
550	82	25x35	0.85	1900	3230
550	82	30x25	0.85	1900	3230
550	100	25x35	0.94	1560	2650
550	100	30x30	1.05	1560	2650
550	120	25x40	1.08	1300	2210
550	120	30x35	1.18	1300	2210

WV (Vdc)	Cap (uF)	Size (mm)	Rated Ripple current (Arms/85°C /120Hz)	Typ. ESR 20°C 120Hz (mΩ)	MAX ESR 20°C 120Hz (mΩ)
550	120	35x25	1.18	1300	2210
550	150	25x50	1.28	1040	1770
550	150	30x35	1.30	1040	1770
550	150	35x30	1.45	1040	1770
550	180	25x55	1.48	860	1470
550	180	30x40	1.48	860	1470
550	180	35x35	1.62	860	1470
550	220	30x50	1.85	710	1210
550	220	35x40	1.86	710	1210
550	270	30x55	2.15	580	980
550	270	35x45	2.21	580	980
550	330	35x50	2.20	470	800
550	390	35x55	2.82	400	680
600	47	25x25	0.62	3320	5640
600	56	25x30	0.71	2790	4740
600	68	25x35	0.77	2290	3900
600	68	30x25	0.78	2290	3900
600	82	25x35	0.87	1900	3230
600	82	30x30	0.92	1900	3230
600	100	25x40	1.00	1560	2650
600	100	30x35	1.10	1560	2650
600	100	35x25	1.10	1560	2650
600	120	25x50	1.20	1300	2210
600	120	30x35	1.18	1300	2210
600	120	35x30	1.30	1300	2210
600	150	25x55	1.36	1040	1770
600	150	30x45	1.47	1040	1770
600	150	35x35	1.52	1040	1770
600	180	30x50	1.67	860	1470
600	180	35x40	1.71	860	1470
600	220	30x55	1.95	710	1210
600	220	35x45	1.95	710	1210
600	270	35x50	2.25	580	980

Useful life

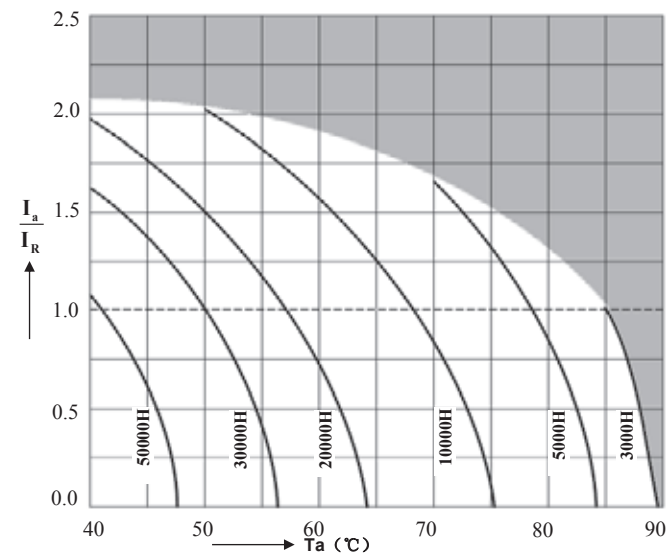

depending on ambient temperature T_a versus under ripple current operating conditions $VR \leq 100V$

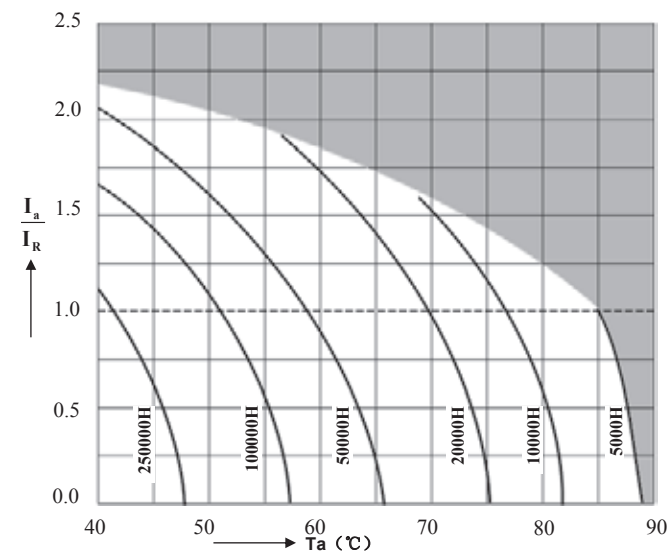

depending on ambient temperature T_a versus under ripple current operating conditions $VR \geq 160V$

LU Series 85°C 3000H

Features

Standard capacitors

Applications

- ◆ Switch-mode power supplies in industrial and entertainment electronics
- ◆ Uninterruptible power supplies

Features

- ◆ High reliability
- ◆ Long useful life
- ◆ High ripple current capability
- ◆ Aluminum case designed explosion-proof vent
- ◆ RoHS-compatible

Construction

- ◆ Charge-discharge proof, polar
- ◆ Aluminum case with insulating sleeve
- ◆ Aluminum case designed explosion-proof vent
- ◆ Snap-in solder pins to hold component in place on PC-board



Specifications

Item	Performance Characteristics											
Operating Temperature Range	-40 to +85°C	-25 to +85°C										
Rated voltage V_R	10 to 450 V DC	500 to 600 V DC										
Surge voltage V_S	$V_R \leq 315V$ 1.15 V_R $V_R > 315V$ 1.10 V_R											
Rated capacitance C_R	47 to 82000 μF	47 to 1500 μF										
Capacitance tolerance	$\pm 20\%$ (120Hz,+20°C)											
Leakage Current I_{leak} (+20°C.max.)	$I \leq 3 \sqrt{CV}$ (μA)After 5minutes with rated working voltage applied											
Dissipation Factor ($\tan \delta$, at 20°C, 120Hz)	Less than the value under table(%)											
	$\mu F/Vdc$	6.3	10	16	25	35	50	63	80	100	160~420	450~600
	≤ 8200	-	35	35	30	25	20	20	15	15	15	20
	10000 to 22000	55	40	40	35	30	30	25	15	-	-	-
≥ 27000	60	50	40	35	35	30	25	-	-	-	-	
Self-inductance ESL	approx. 20 nH											
Useful life 85°C; $V_R, I_{AC,R}$ 85°C; $V_R, I_{AC,R}$	$V_R \leq 100V$:	Requirements:										
	>4000 h	$V_R \leq 100V$ DC/C $\leq \pm 30\%$ of initial value ESR ≤ 3 times initial specified limit $I_{leak} \leq$ initial specified limit					$V_R > 100V$ DC/C $\leq \pm 20\%$ of initial value ESR ≤ 2 times initial specified limit $I_{leak} \leq$ initial specified limit					
Voltage Endurance test 85°C; V_R	3000 h	Post test requirements:										
		$V_R \leq 100V$ DC/C $\leq \pm 15\%$ of initial value ESR ≤ 1.3 times initial specified limit $I_{leak} \leq$ initial specified limit					$V_R > 100V$ DC/C $\leq \pm 10\%$ of initial value ESR ≤ 1.3 times initial specified limit $I_{leak} \leq$ initial specified limit					
Shelf Life 85°C	1000 h	Post test requirements:										
		$V_R \leq 100V$ DC/C $\leq \pm 15\%$ of initial value ESR ≤ 1.3 times initial specified limit $I_{leak} \leq$ initial specified limit					$V_R > 100V$ DC/C $\leq \pm 10\%$ of initial value ESR ≤ 1.3 times initial specified limit $I_{leak} \leq$ initial specified limit					
Vibration Resistance test	To IEC 60068-2-6, test Fc: Displacement amplitude 0.75 mm, frequency range 10 ... 55 Hz, acceleration max. 10 g, duration 3x2 h. Capacitor mounted by its body which is rigidly clamped to the work surface.											
Characteristics at low temperature	Max. impedance ratio at 120 Hz											
	$V_R(V)$	6.3	10	16	25	35~100	160~250	315~450	500~600			
	$Z_{-25^\circ C} / Z_{20^\circ C}$	5	5	5	4	4	4	8	8			
$Z_{-40^\circ C} / Z_{20^\circ C}$	15	15	15	15	12	7	10	-				
Sectional specification	IEC 60384-4 and JIS-C-5101											

Snap-in

Multiplier for Ripple Current vs. Frequency

$V_R(V)/$ Frequency(Hz)	50(60)	120	300	1K	10K	50K-100K
$10 \leq V_R \leq 100$	0.88	1	1.07	1.15	1.15	1.15
$160 \leq V_R \leq 250$	0.81	1	1.17	1.32	1.45	1.5
$315 \leq V_R \leq 600$	0.77	1	1.16	1.30	1.41	1.43

Dimensional drawings

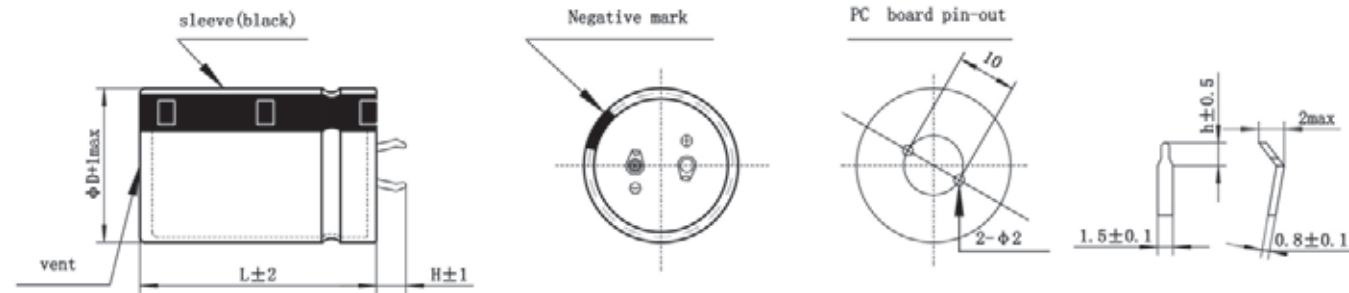

Standard snap-in terminals: length (6.0 ± 1) mm
 Also available with length of (4.0 ± 1) mm

H	h
6	2.5
4	1.5

Packing

Capacitor diameter D(mm)	Length L(mm)	Terminal length H(mm)	Each carton packing Qty units(pcs.)	Box/carton units(pcs.)	Each box packing Qty units(pcs.)
20	all	/	720	6	120
22	< 55	/	600	6	100
22	≥ 55	/	400	4	100
25	< 65	/	500	5	100
25	≥ 65	/	400	4	100
30	≤ 36	< 6(L=35、36)	400	8	50
30	35 ≤ L ≤ 65	≥ 6(L=35、36)	300	6	50
30	> 65	/	200	4	50
35	≤ 25	/	400	8	50
35	25 < L < 45	/	300	6	50
35	45 ≤ L ≤ 85	/	200	4	50
35	> 85	/	100	2	50
40	35	< 6	200	5	40
40	35	≥ 6	160	4	40
40	40 ≤ L ≤ 45	/	160	4	40
40	45 < L ≤ 75	/	120	3	40
40	> 75	/	80	2	40
45	40 ≤ L ≤ 65	/	140	4	35
45	65 < L ≤ 100	/	70	2	35

Packing of snap-in



Case Size

WV (Vdc)	Cap (uF)	Size (mm)	Rated Ripple current (Arms/85°C /120Hz)	Typ. ESR 20°C 120Hz (mΩ)	MAX ESR 20°C 120Hz (mΩ)
10	10000	20x25	2.23	36	46
10	12000	22x25	2.90	34	44
10	15000	22x30	3.20	27	35
10	15000	25x25	3.21	27	35
10	18000	22x35	3.22	23	29
10	18000	25x30	3.65	23	29
10	22000	22x40	3.79	19	24
10	22000	25x30	3.75	19	24
10	22000	30x25	4.10	19	24
10	27000	25x35	4.04	19	25
10	27000	30x30	4.06	19	25
10	33000	25x40	4.60	15	20
10	33000	30x30	4.80	15	20
10	39000	25x45	5.29	13	17
10	39000	35x30	5.30	13	17
10	47000	25x50	5.80	11	14
10	47000	30x40	5.82	11	14
10	47000	35x30	6.00	11	14
10	56000	30x45	6.70	9	12
10	56000	35x35	6.80	9	12
10	68000	30x50	7.50	8	10
10	68000	35x40	7.55	8	10
10	82000	35x45	8.70	6	8
16	8200	20x25	2.57	44	57
16	10000	22x25	2.86	36	46
16	12000	22x25	2.89	34	44
16	15000	22x30	3.45	27	35
16	18000	25x25	3.47	23	29
16	22000	25x30	3.94	19	24
16	27000	30x30	4.99	15	20
16	33000	30x35	5.49	12	16
16	33000	35x25	5.21	12	16
16	39000	30x40	6.11	10	14
16	39000	35x30	6.13	10	14
16	47000	30x45	6.95	9	11
16	56000	30x50	7.63	7	10
16	56000	35x40	7.69	7	10
16	68000	35x45	8.45	6	8
16	82000	35x50	9.15	5	7
25	5600	20x25	2.33	55	71
25	5600	22x25	2.40	55	71
25	6800	22x25	2.62	45	59
25	6800	25x25	2.68	45	59
25	8200	22x30	2.91	37	49
25	8200	25x25	2.95	37	49
25	10000	22x35	3.31	31	40
25	10000	25x25	3.18	31	40
25	12000	22x40	3.77	30	39
25	12000	25x30	3.65	30	39
25	15000	22x45	4.08	24	31
25	15000	25x35	4.10	24	31
25	18000	25x40	4.68	20	26
25	18000	30x30	4.71	20	26
25	22000	25x45	4.72	16	21
25	22000	30x35	4.75	16	21
25	27000	25x50	6.02	13	17
25	27000	30x40	6.10	13	17
25	27000	35x35	6.12	13	17

WV (Vdc)	Cap (uF)	Size (mm)	Rated Ripple current (Arms/85°C /120Hz)	Typ. ESR 20°C 120Hz (mΩ)	MAX ESR 20°C 120Hz (mΩ)
25	33000	30x45	6.75	11	14
25	33000	35x40	6.80	11	14
25	39000	30x50	7.40	9	12
25	39000	35x45	7.61	9	12
25	47000	35x50	8.30	8	10
35	3300	20x25	2.14	77	100
35	3900	20x30	2.28	65	85
35	3900	22x25	2.22	65	85
35	4700	20x35	2.46	54	71
35	4700	22x25	2.47	54	71
35	5600	22x30	2.80	46	59
35	5600	25x25	2.82	46	59
35	6800	22x35	2.89	38	49
35	6800	25x30	2.92	38	49
35	6800	30x25	3.09	38	49
35	8200	22x40	3.47	31	40
35	8200	25x35	3.50	31	40
35	8200	30x25	3.51	31	40
35	10000	22x45	3.60	26	33
35	10000	25x40	3.65	26	33
35	10000	30x30	3.67	26	33
35	10000	35x25	3.71	26	33
35	12000	25x40	4.51	26	33
35	12000	30x35	4.55	26	33
35	12000	35x25	4.52	26	33
35	15000	25x45	4.55	20	27
35	15000	30x40	4.80	20	27
35	15000	35x30	4.82	20	27
35	18000	25x50	4.84	17	22
35	18000	30x40	4.87	17	22
35	18000	35x35	5.70	17	22
35	22000	30x45	6.38	14	18
35	22000	35x40	6.40	14	18
35	27000	35x45	6.90	13	17
35	33000	35x50	7.49	11	14
50	2200	20x25	2.07	92	120
50	2200	22x25	2.19	92	120
50	2700	20x30	2.21	76	98
50	2700	22x25	2.21	76	98
50	3300	20x35	2.41	62	80
50	3300	22x30	2.41	62	80
50	3300	25x25	2.41	62	80
50	3900	20x40	2.72	52	68
50	3900	22x30	2.61	52	68
50	3900	25x25	2.56	52	68
50	4700	22x35	2.93	43	56
50	4700	25x30	3.07	43	56
50	4700	30x25	3.01	43	56
50	5600	22x40	3.41	36	47
50	5600	25x35	3.47	36	47
50	5600	30x25	3.37	36	47
50	6800	22x45	3.94	30	39
50	6800	25x35	3.89	30	39
50	6800	30x30	3.86	30	39
50	6800	35x25	3.84	30	39
50	8200	25x45	4.44	25	32
50	8200	30x35	4.47	25	32
50	8200	35x30	4.47	25	32

WV (Vdc)	Cap (uF)	Size (mm)	Rated Ripple current (Arms/85°C /120Hz)	Typ. ESR 20°C 120Hz (mΩ)	MAX ESR 20°C 120Hz (mΩ)
50	10000	25x50	5.02	20	27
50	10000	30x40	5.08	20	27
50	10000	35x30	5.02	20	27
50	12000	30x45	5.60	26	33
50	12000	35x35	5.60	26	33
50	15000	30x50	6.44	20	27
50	15000	35x45	6.56	20	27
50	18000	35x45	7.18	17	22
63	1500	20x25	1.70	140	180
63	1500	22x25	1.75	140	180
63	1800	20x30	2.05	120	150
63	1800	22x25	2.04	120	150
63	2200	20x35	2.40	92	120
63	2200	22x30	2.41	92	120
63	2200	25x25	2.43	92	120
63	2700	20x40	2.53	76	98
63	2700	22x35	2.54	76	98
63	2700	25x30	2.58	76	98
63	3300	22x35	2.72	62	80
63	3300	25x30	2.74	62	80
63	3300	30x25	2.84	62	80
63	3900	22x40	2.95	52	68
63	3900	25x35	3.16	52	68
63	3900	30x30	3.17	52	68
63	3900	35x25	3.19	52	68
63	4700	22x50	3.69	43	56
63	4700	25x40	3.59	43	56
63	4700	30x30	3.70	43	56
63	4700	35x25	3.71	43	56
63	5600	25x45	3.81	36	47
63	5600	30x35	3.85	36	47
63	5600	35x30	3.91	36	47
63	6800	25x50	4.53	30	39
63	6800	30x40	4.61	30	39
63	6800	35x30	4.95	30	39
63	8200	30x45	5.15	25	32
63	8200	35x35	5.18	25	32
63	10000	30x50	5.80	20	27
63	10000	35x40	5.83	20	27
63	12000	35x45	6.47	21	28
63	15000	35x50	6.61	17	22
80	1000	20x25	1.57	150	200
80	1200	20x30	1.80	130	170
80	1200	22x25	1.77	130	170
80	1500	20x30	2.10	100	130
80	1500	22x30	2.12	100	130
80	1500	25x25	2.16	100	130
80	1800	20x35	2.30	85	110
80	1800	22x30	2.31	85	110
80	1800	25x25	2.35	85	110
80	2200	20x40	2.53	70	90
80	2200	22x35	2.56	70	90
80	2200	25x30	2.58	70	90
80	2200	30x25	2.62	70	90
80	2700	22x40	2.93	57	74
80	2700	25x35	2.95	57	74
80	2700	30x25	2.99	57	74
80	2700	35x25	3.02	57	74
80	3300	22x45	3.25	46	60
80	3300	25x40	3.29	46	60

WV (Vdc)	Cap (uF)	Size (mm)	Rated Ripple current (Arms/85°C /120Hz)	Typ. ESR 20°C 120Hz (mΩ)	MAX ESR 20°C 120Hz (mΩ)
80	3300	30x30	3.31	46	60
80	3300	35x25	3.35	46	60
80	3900	22x50	3.62	39	51
80	3900	25x45	3.71	39	51
80	3900	30x35	3.78	39	51
80	3900	35x30	3.91	39	51
80	4700	25x50	4.28	33	42
80	4700	30x40	4.31	33	42
80	4700	35x30	4.45	33	42
80	5600	30x45	4.70	27	36
80	5600	35x35	4.75	27	36
80	6800	30x50	5.27	23	29
80	6800	35x40	5.35	23	29
80	8200	35x45	5.90	19	24
80	10000	35x50	7.05	15	20
100	680	20x25	1.68	220	290
100	680	22x25	1.71	220	290
100	820	20x30	1.91	180	240
100	820	22x25	1.90	180	240
100	1000	20x30	2.02	150	200
100	1000	22x30	2.04	150	200
100	1000	25x25	2.10	150	200
100	1200	20x35	2.12	130	170
100	1200	22x30	2.15	130	170
100	1200	25x25	2.18	130	170
100	1500	20x40	2.45	100	130
100	1500	22x35	2.47	100	130
100	1500	25x30	2.50	100	130
100	1500	30x25	2.56	100	130
100	1800	22x40	2.77	85	110
100	1800	25x35	2.81	85	110
100	1800	30x25	2.85	85	110
100	1800	35x25	2.89	85	110
100	2200	22x45	3.15	70	90
100	2200	25x40	3.21	70	90
100	2200	30x30	3.25	70	90
100	2200	35x25	3.28	70	90
100	2700	25x45	3.66	57	74
100	2700	30x35	3.70	57	74
100	2700	35x30	3.77	57	74
100	3300	25x50	4.15	46	60
100	3300	30x40	4.18	46	60
100	3300	35x35	4.21	46	60
100	3900	30x45	4.67	39	51
100	3900	35x35	4.69	39	51
100	4700	30x50	5.26	33	42
100	4700	35x40	5.31	33	42
100	5600	35x45	5.89	27	36
100	6800	35x50	6.01	23	29
160	220	20x25	1.11	510	900
160	270	20x25	1.12	420	740
160	270	22x25	1.27	420	740
160	330	20x30	1.28	340	600
160	330	22x25	1.55	340	600
160	390	20x30	1.63	290	510
160	390	22x25	1.65	290	510
160	390	25x20	1.67	290	510
160	470	22x30	1.90	240	420
160	470	25x25	1.92	240	420
160	560	22x30	2.15	210	360

WV (Vdc)	Cap (uF)	Size (mm)	Rated Ripple current (Arms/85°C /120Hz)	Typ. ESR 20°C 120Hz (mΩ)	MAX ESR 20°C 120Hz (mΩ)
160	560	25x25	2.18	210	360
160	560	30x20	2.21	210	360
160	680	22x35	2.35	170	290
160	680	25x30	2.38	170	290
160	680	30x25	2.42	170	290
160	680	35x20	2.51	170	290
160	820	22x40	2.68	140	240
160	820	25x30	2.71	140	240
160	820	30x25	2.76	140	240
160	820	35x20	2.79	140	240
160	1000	22x45	3.02	110	200
160	1000	25x35	3.03	110	200
160	1000	30x30	3.05	110	200
160	1000	35x25	3.13	110	200
160	1200	22x45	3.25	97	170
160	1200	25x40	3.43	97	170
160	1200	30x30	3.45	97	170
160	1200	35x25	3.48	97	170
160	1500	25x50	3.96	74	130
160	1500	30x35	4.01	74	130
160	1500	35x30	4.03	74	130
160	1800	25x50	4.20	63	110
160	1800	30x40	4.31	63	110
160	1800	35x35	4.38	63	110
160	2200	30x45	4.85	52	90
160	2200	35x40	4.90	52	90
160	2700	30x50	5.45	42	74
160	2700	35x45	5.57	42	74
160	3300	35x50	6.21	34	60
160	3300	40x50	6.34	34	60
160	3900	35x80	7.84	29	51
160	3900	40x60	7.45	29	51
160	4700	40x80	8.79	24	42
180	220	22x20	1.18	510	900
180	270	20x25	1.29	420	740
180	330	20x30	1.77	340	600
180	330	22x25	1.79	340	600
180	330	25x20	1.81	340	600
180	390	20x30	1.84	290	510
180	470	20x30	2.08	240	420
180	470	22x25	2.08	240	420
180	470	30x20	1.88	240	420
180	560	20x35	2.25	210	360
180	560	22x30	2.26	210	360
180	560	25x25	2.27	210	360
180	680	20x40	2.50	170	290
180	680	22x35	2.51	170	290
180	680	25x30	2.53	170	290
180	680	30x25	2.55	170	290
180	680	35x20	2.57	170	290
180	820	20x45	2.75	140	240
180	820	22x40	2.86	140	240
180	820	25x35	2.87	140	240
180	820	30x25	2.89	140	240
180	1000	22x50	3.10	110	200
180	1000	25x40	3.06	110	200
180	1000	30x30	3.11	110	200
180	1200	22x50	3.31	97	170
180	1200	25x45	3.65	97	170
180	1200	30x35	3.67	97	170

WV (Vdc)	Cap (uF)	Size (mm)	Rated Ripple current (Arms/85°C /120Hz)	Typ. ESR 20°C 120Hz (mΩ)	MAX ESR 20°C 120Hz (mΩ)
180	1200	35x30	3.71	97	170
180	1500	25x50	3.83	74	130
180	1500	30x40	4.10	74	130
180	1500	35x35	4.21	74	130
180	1800	30x45	4.55	63	110
180	1800	35x35	4.58	63	110
180	2200	30x50	4.92	52	90
180	2200	35x40	4.96	52	90
180	2700	35x50	5.30	42	74
200	120	22x20	1.05	950	1660
200	220	22x20	1.19	510	900
200	220	22x25	1.25	510	900
200	270	22x25	1.39	420	740
200	270	25x20	1.40	420	740
200	330	22x25	1.52	340	600
200	330	25x20	1.56	340	600
200	390	22x30	1.73	290	510
200	390	25x25	1.74	290	510
200	470	22x30	1.97	240	420
200	470	25x25	1.99	240	420
200	560	22x35	2.45	210	360
200	560	25x30	2.48	210	360
200	560	30x25	2.51	210	360
200	680	22x40	2.70	170	290
200	680	25x30	2.68	170	290
200	680	30x25	2.72	170	290
200	820	22x45	2.94	140	240
200	820	25x35	2.93	140	240
200	820	30x30	2.96	140	240
200	1000	22x50	3.28	110	200
200	1000	25x40	3.28	110	200
200	1000	30x35	3.29	110	200
200	1000	35x30	3.30	110	200
200	1200	30x35	3.61	97	170
200	1200	35x30	3.63	97	170
200	1500	30x45	4.13	74	130
200	1500	35x35	4.14	74	130
200	1800	30x50	4.60	63	110
200	1800	35x40	4.61	63	110
200	2200	35x45	4.98	52	90
200	2700	35x50	5.46	42	74
200	3300	35x60	6.30	34	60
200	3900	40x60	7.40	29	51
200	4700	40x70	6.78	24	42
200	5600	35x100	7.37	20	36
200	6800	40x100	8.66	17	29
220	180	22x20	1.07	630	1110
220	270	25x20	1.35	420	740
220	330	22x30	1.70	340	600
220	330	25x25	1.71	340	600
220	390	22x30	1.89	290	510
220	390	25x25	1.91	290	510
220	470	22x35	2.08	240	420
220	470	25x30	2.10	240	420
220	470	30x25	2.13	240	420
220	560	22x40	2.33	210	360
220	560	25x35	2.39	210	360
220	560	30x25	2.35	210	360
220	680	22x45	2.68	170	290
220	680	25x35	2.68	170	290

WV (Vdc)	Cap (uF)	Size (mm)	Rated Ripple current (Arms/85°C /120Hz)	Typ. ESR 20°C 120Hz (mΩ)	MAX ESR 20°C 120Hz (mΩ)
220	680	30x30	2.69	170	290
220	820	25x45	3.01	140	240
220	820	30x35	3.02	140	240
220	820	35x30	3.03	140	240
220	1000	25x50	3.43	110	200
220	1000	30x35	3.42	110	200
220	1200	30x40	3.88	97	170
220	1200	35x35	3.89	97	170
220	1500	30x50	4.44	74	130
220	1500	35x40	4.45	74	130
220	1800	35x45	4.53	63	110
220	2200	35x50	4.98	52	90
250	100	22x25	0.69	1140	1990
250	150	22x20	0.98	760	1330
250	180	22x20	1.07	630	1110
250	220	22x25	1.26	510	900
250	220	25x20	1.27	510	900
250	270	22x25	1.51	420	740
250	330	22x30	1.75	340	600
250	330	25x25	1.76	340	600
250	390	22x35	1.91	290	510
250	390	25x30	1.92	290	510
250	390	30x25	1.93	290	510
250	470	22x35	2.15	240	420
250	470	25x35	2.16	240	420
250	470	30x25	2.16	240	420
250	560	22x40	2.48	210	360
250	560	25x35	2.49	210	360
250	560	30x25	2.49	210	360
250	680	22x50	2.71	170	290
250	680	25x40	2.71	170	290
250	680	30x30	2.71	170	290
250	820	25x45	3.01	140	240
250	820	30x35	3.02	140	240
250	820	35x30	3.03	140	240
250	1000	30x40	3.56	110	200
250	1000	35x35	3.57	110	200
250	1200	30x45	3.99	97	170
250	1200	35x35	4.01	97	170
250	1500	35x40	4.34	74	130
250	1800	35x50	4.56	63	110
250	2200	35x50	5.01	52	90
250	2700	40x80	6.31	42	74
250	3300	40x80	7.01	34	60
250	3900	35x100	7.48	29	51
250	4700	40x100	8.89	24	42
315	100	22x20	0.80	1140	1990
315	120	25x20	0.91	950	1660
315	150	22x25	1.07	760	1330
315	150	25x20	1.08	760	1330
315	180	22x30	1.38	630	1110
315	180	25x25	1.39	630	1110
315	220	22x30	1.47	510	900
315	220	25x25	1.47	510	900
315	220	30x20	1.48	510	900
315	270	22x35	1.70	420	740
315	270	25x30	1.71	420	740
315	270	30x25	1.72	420	740
315	270	35x20	1.73	420	740
315	330	22x40	1.99	340	600

WV (Vdc)	Cap (uF)	Size (mm)	Rated Ripple current (Arms/85°C /120Hz)	Typ. ESR 20°C 120Hz (mΩ)	MAX ESR 20°C 120Hz (mΩ)
315	330	25x35	2.00	340	600
315	330	30x25	1.99	340	600
315	390	22x45	2.15	290	510
315	390	25x40	2.16	290	510
315	390	30x30	2.16	290	510
315	390	35x25	2.17	290	510
315	470	25x45	2.46	240	420
315	470	30x35	2.47	240	420
315	470	35x30	2.48	240	420
315	560	25x50	2.71	210	360
315	560	30x35	2.70	210	360
315	560	35x30	2.72	210	360
315	680	30x45	3.06	170	290
315	680	35x35	3.06	170	290
315	820	30x50	3.45	140	240
315	820	35x40	3.46	140	240
315	1000	35x45	3.60	110	200
350	82	22x20	0.73	1390	2430
350	100	22x25	0.81	1140	1990
350	120	22x25	1.05	950	1660
350	120	25x20	1.07	950	1660
350	150	22x30	1.24	760	1330
350	150	25x25	1.25	760	1330
350	180	22x30	1.37	630	1110
350	180	25x25	1.38	630	1110
350	180	30x20	1.39	630	1110
350	220	22x35	1.54	510	900
350	220	25x30	1.55	510	900
350	220	30x25	1.56	510	900
350	220	35x20	1.57	510	900
350	270	22x40	1.80	420	740
350	270	25x35	1.81	420	740
350	270	30x25	1.81	420	740
350	330	22x45	2.03	340	600
350	330	25x35	2.03	340	600
350	330	30x30	2.04	340	600
350	330	35x25	2.05	340	600
350	390	25x40	2.24	290	510
350	390	30x35	2.25	290	510
350	390	35x30	2.26	290	510
350	470	25x50	2.57	240	420
350	470	30x35	2.56	240	420
350	470	35x30	2.56	240	420
350	560	30x40	2.76	210	360
350	560	35x35	2.77	210	360
350	680	30x50	3.21	170	290
350	680	35x40	3.22	170	290
350	820	35x45	3.52	140	240
350	1000	35x50	3.66	110	200
350	1200	40x65	5.71	97	170
350	1500	45x60	6.48	74	130
350	1800	45x70	7.40	63	110
350	2200	45x80	8.08	52	90
350	2700	45x100	9.49	42	74
400	68	20x25	0.65	1670	2930
400	68	22x20	0.65	1670	2930
400	82	22x25	0.85	1390	2430
400	82	25x20	0.86	1390	2430
400	100	22x25	0.99	1140	1990
400	100	25x20	1.00	1140	1990

WV (Vdc)	Cap (uF)	Size (mm)	Rated Ripple current (Arms/85°C /120Hz)	Typ. ESR 20°C 120Hz (mΩ)	MAX ESR 20°C 120Hz (mΩ)
400	120	22x25	1.10	950	1660
400	120	25x25	1.14	950	1660
400	150	22x30	1.25	760	1330
400	150	22x35	1.38	760	1330
400	150	25x25	1.30	760	1330
400	150	25x30	1.40	760	1330
400	150	30x25	1.42	760	1330
400	180	22x30	1.50	630	1110
400	180	22x35	1.55	630	1110
400	180	25x25	1.52	630	1110
400	180	25x30	1.58	630	1110
400	180	30x25	1.60	630	1110
400	180	35x20	1.63	630	1110
400	220	22x30	1.54	510	900
400	220	22x45	1.62	510	900
400	220	25x25	1.56	510	900
400	220	25x30	1.60	510	900
400	220	25x35	1.64	510	900
400	220	30x25	1.62	510	900
400	220	30x30	1.65	510	900
400	270	22x35	1.60	420	740
400	270	22x45	1.70	420	740
400	270	25x30	1.65	420	740
400	270	25x40	1.82	420	740
400	270	30x25	1.68	420	740
400	270	30x30	1.82	420	740
400	330	22x40	1.98	340	600
400	330	22x50	2.27	340	600
400	330	25x35	2.05	340	600
400	330	25x45	2.29	340	600
400	330	30x25	2.06	340	600
400	330	30x35	2.31	340	600
400	330	35x25	2.30	340	600
400	330	35x30	2.40	340	600
400	390	22x50	2.29	290	510
400	390	25x45	2.36	290	510
400	390	30x30	2.30	290	510
400	390	30x40	2.46	290	510
400	390	35x25	2.38	290	510
400	390	35x35	2.50	290	510
400	470	25x50	2.45	240	420
400	470	30x35	2.42	240	420
400	470	30x45	2.66	240	420
400	470	35x25	2.40	240	420
400	470	35x30	2.60	240	420
400	470	35x35	2.71	240	420
400	560	25x55	3.08	210	360
400	560	30x50	3.19	210	360
400	560	35x30	3.03	210	360
400	560	35x40	3.44	210	360
400	680	25x60	3.28	170	290
400	680	30x45	3.25	170	290
400	680	30x55	3.28	170	290
400	680	35x50	3.45	170	290
400	820	30x60	3.42	140	240
400	820	35x45	3.42	140	240
400	820	35x50	3.50	140	240
400	1000	35x50	3.60	110	200
400	1000	35x55	3.85	110	200
400	1000	40x65	5.15	110	200

WV (Vdc)	Cap (uF)	Size (mm)	Rated Ripple current (Arms/85°C /120Hz)	Typ. ESR 20°C 120Hz (mΩ)	MAX ESR 20°C 120Hz (mΩ)
400	1200	35x65	4.68	97	170
400	1200	40x60	4.71	97	170
400	1500	35x80	5.55	74	130
400	1500	40x70	4.61	74	130
400	1800	40x80	6.60	63	110
400	2200	45x95	8.70	52	90
420	47	22x20	0.54	3220	5640
420	56	22x20	0.60	2710	4740
420	68	25x20	0.68	2230	3900
420	82	20x25	0.83	1850	3230
420	82	22x25	0.85	1850	3230
420	82	25x20	0.85	1850	3230
420	100	22x25	0.97	1510	2650
420	100	22x30	0.98	1510	2650
420	100	25x25	0.98	1510	2650
420	120	20x30	1.05	1260	2210
420	120	22x25	1.02	1260	2210
420	120	22x30	1.07	1260	2210
420	120	25x25	1.08	1260	2210
420	120	30x20	1.10	1260	2210
420	150	22x25	1.11	1010	1770
420	150	22x35	1.21	1010	1770
420	150	25x30	1.26	1010	1770
420	150	35x20	1.32	1010	1770
420	180	22x30	1.32	840	1470
420	180	22x40	1.33	840	1470
420	180	25x25	1.33	840	1470
420	180	25x35	1.46	840	1470
420	180	30x25	1.48	840	1470
420	180	35x20	1.48	840	1470
420	220	22x35	1.42	690	1210
420	220	22x45	1.60	690	1210
420	220	25x30	1.47	690	1210
420	220	25x35	1.58	690	1210
420	220	30x25	1.59	690	1210
420	220	30x30	1.65	690	1210
420	220	35x25	1.60	690	1210
420	270	22x45	1.75	560	980
420	270	25x30	1.68	560	980
420	270	25x40	1.98	560	980
420	270	30x25	1.70	560	980
420	270	30x35	1.92	560	980
420	270	35x30	1.94	560	980
420	330	25x40	1.95	460	800
420	330	25x50	2.28	460	800
420	330	30x30	1.98	460	800
420	330	30x35	2.20	460	800
420	330	35x25	2.17	460	800
420	330	35x35	2.37	460	800
420	390	25x50	2.30	390	680
420	390	30x30	2.10	390	680
420	390	30x40	2.32	390	680
420	390	35x25	2.20	390	680
420	390	35x35	2.68	390	680
420	470	30x35	2.47	320	560
420	470	30x45	2.72	320	560
420	470	35x30	2.63	320	560
420	470	35x40	2.75	320	560
420	560	25x55	2.82	270	470
420	560	30x40	2.70	270	470

WV (Vdc)	Cap (uF)	Size (mm)	Rated Ripple current (Arms/85°C /120Hz)	Typ. ESR 20°C 120Hz (mΩ)	MAX ESR 20°C 120Hz (mΩ)
420	560	30x50	2.85	270	470
420	560	35x35	2.70	270	470
420	560	35x45	2.95	270	470
420	680	30x50	2.90	220	390
420	680	35x40	3.15	220	390
420	680	35x50	3.20	220	390
420	820	30x55	3.40	180	320
420	820	35x45	3.45	180	320
420	820	35x55	3.72	180	320
420	820	40x45	3.72	180	320
420	1000	35x50	3.78	150	270
420	1000	35x65	4.50	150	270
420	1000	40x50	4.30	150	270
420	1200	35x60	3.90	130	220
420	1200	35x70	4.95	130	220
420	1200	40x55	4.60	130	220
420	1500	40x70	5.98	100	180
420	1800	40x80	6.90	86	150
450	47	22x20	0.55	3220	5640
450	56	20x25	0.61	2710	4740
450	56	22x20	0.59	2710	4740
450	68	20x25	0.62	2230	3900
450	68	22x25	0.71	2230	3900
450	68	25x20	0.72	2230	3900
450	82	20x30	0.87	1850	3230
450	82	22x25	0.86	1850	3230
450	82	25x20	0.88	1850	3230
450	100	20x35	0.91	1510	2650
450	100	22x30	0.95	1510	2650
450	100	25x25	0.97	1510	2650
450	120	22x30	1.05	1260	2210
450	120	25x25	1.07	1260	2210
450	150	22x35	1.29	1010	1770
450	150	25x30	1.31	1010	1770
450	150	30x25	1.34	1010	1770
450	150	35x20	1.36	1010	1770
450	180	22x35	1.38	840	1470
450	180	25x30	1.40	840	1470
450	180	30x25	1.44	840	1470
450	180	30x30	1.45	840	1470
450	180	35x25	1.47	840	1470
450	220	22x40	1.87	690	1210
450	220	25x35	1.89	690	1210
450	220	30x30	1.91	690	1210
450	220	35x25	1.92	690	1210
450	270	25x35	2.12	560	980
450	270	30x30	2.15	560	980
450	270	35x25	2.19	560	980
450	330	25x40	2.41	460	800
450	330	30x35	2.48	460	800
450	330	35x30	2.53	460	800
450	330	35x35	2.63	460	800
450	390	25x45	2.67	390	680
450	390	30x35	2.70	390	680
450	390	35x30	2.75	390	680
450	470	25x50	2.78	320	560
450	470	30x40	2.82	320	560
450	470	30x45	2.88	320	560
450	470	35x35	2.93	320	560
450	560	30x45	3.13	270	470

WV (Vdc)	Cap (uF)	Size (mm)	Rated Ripple current (Arms/85°C /120Hz)	Typ. ESR 20°C 120Hz (mΩ)	MAX ESR 20°C 120Hz (mΩ)
450	560	30x50	3.17	270	470
450	560	35x40	3.21	270	470
450	560	40x50	3.46	270	470
450	560	45x40	3.48	270	470
450	680	30x50	3.46	220	390
450	680	35x40	3.51	220	390
450	680	35x45	3.65	220	390
450	680	40x60	3.98	220	390
450	680	45x45	4.01	220	390
450	820	30x60	3.97	180	320
450	820	35x45	3.90	180	320
450	820	35x50	4.01	180	320
450	820	45x55	4.47	180	320
450	1000	35x55	4.01	150	270
450	1000	35x60	4.11	150	270
450	1000	40x55	4.60	150	270
450	1000	45x60	5.08	150	270
450	1200	40x65	5.42	130	220
450	1200	45x60	5.79	130	220
450	1500	45x85	6.84	100	180
450	1800	45x100	7.86	86	150
450	2200	45x90	8.48	69	120
500	47	22x20	0.56	3220	5640
500	56	20x25	0.62	2710	4740
500	56	22x25	0.63	2710	4740
500	56	25x20	0.64	2710	4740
500	68	20x30	0.65	2230	3900
500	68	22x25	0.63	2230	3900
500	68	22x30	0.75	2230	3900
500	68	25x20	0.68	2230	3900
500	68	25x25	0.78	2230	3900
500	82	20x30	0.85	1850	3230
500	82	22x30	0.92	1850	3230
500	82	25x25	0.95	1850	3230
500	100	22x35	1.02	1510	2650
500	100	25x30	1.06	1510	2650
500	100	30x20	1.04	1510	2650
500	100	30x25	1.07	1510	2650
500	120	22x40	1.12	1260	2210
500	120	25x30	1.08	1260	2210
500	120	25x35	1.23	1260	2210
500	120	30x30	1.25	1260	2210
500	120	35x25	1.28	1260	2210
500	150	22x45	1.26	1010	1770
500	150	25x35	1.25	1010	1770
500	150	25x40	1.28	1010	1770
500	150	30x30	1.34	1010	1770
500	150	30x35	1.38	1010	1770
500	150	35x25	1.36	1010	1770
500	180	22x50	1.39	840	1470
500	180	25x40	1.30	840	1470
500	180	25x45	1.45	840	1470
500	180	30x30	1.28	840	1470
500	180	30x35	1.47	840	1470
500	180	35x20	1.21	840	1470
500	180	35x25	1.46	840	1470
500	220	25x50	1.52	690	1210
500	220	30x35	1.51	690	1210
500	220	30x40	1.60	690	1210
500	220	35x30	1.62	690	1210

WV (Vdc)	Cap (uF)	Size (mm)	Rated Ripple current (Arms/85°C /120Hz)	Typ. ESR 20°C 120Hz (mΩ)	MAX ESR 20°C 120Hz (mΩ)
500	270	30x40	1.77	560	980
500	270	30x45	1.98	560	980
500	270	35x35	2.02	560	980
500	330	30x50	2.25	460	800
500	330	35x35	2.03	460	800
500	330	35x40	2.27	460	800
500	390	35x45	2.45	390	680
500	470	35x50	2.76	320	560
500	560	35x60	2.90	270	470
500	560	40x50	3.31	270	470
500	680	35x70	3.82	220	390
500	680	40x55	3.79	220	390
500	820	35x80	4.56	180	320
500	820	40x60	4.33	180	320
500	1000	35x90	5.31	150	270
500	1000	40x80	5.42	150	270

WV (Vdc)	Cap (uF)	Size (mm)	Rated Ripple current (Arms/85°C /120Hz)	Typ. ESR 20°C 120Hz (mΩ)	MAX ESR 20°C 120Hz (mΩ)
500	1500	40x100	6.56	100	180
600	150	30x45	0.95	1010	1770
600	180	30x50	1.10	840	1470
600	220	30x60	1.22	690	1210
600	270	30x70	1.25	560	980
600	330	30x80	1.36	460	800
600	330	40x50	1.35	460	800
600	390	40x60	1.48	390	680
600	470	40x70	1.67	320	560
600	470	45x55	1.65	320	560
600	560	40x80	1.78	270	470
600	560	45x60	1.75	270	470
600	680	40x90	1.85	220	390
600	680	45x70	1.83	220	390
600	820	45x85	2.01	180	320
600	1000	45x100	2.28	150	270

Useful life

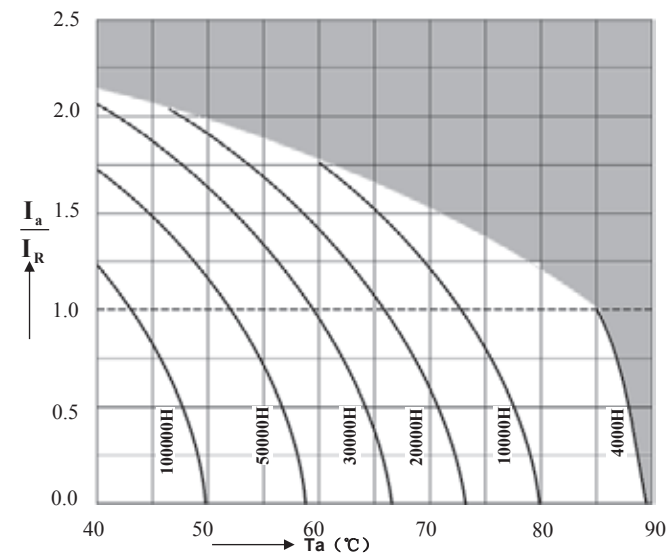

depending on ambient temperature T_a versus under ripple current operating conditions $VR \leq 100V$

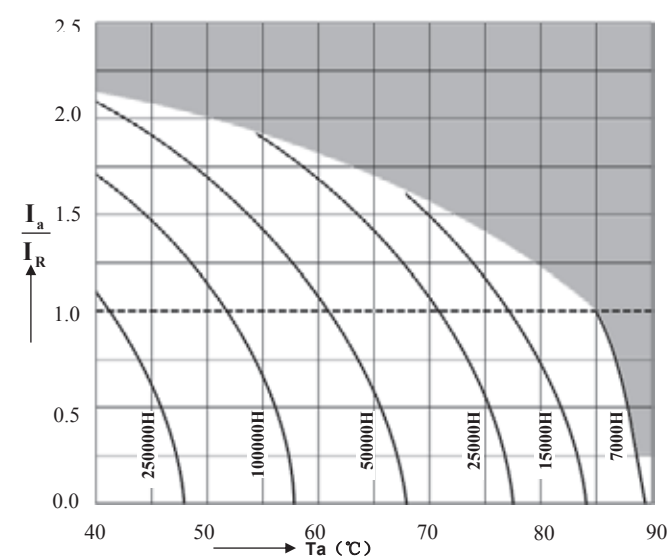

depending on ambient temperature T_a versus under ripple current operating conditions $VR \geq 160V$

LD Series 85°C 5000H



Features

Standard capacitors

Applications

- ◆ Switch-mode power supplies in industrial and entertainment electronics
- ◆ Uninterruptible power supplies

Features

- ◆ High reliability
- ◆ Long useful life
- ◆ High ripple current capability
- ◆ Aluminum case designed explosion-proof vent
- ◆ RoHS-compatible

Construction

- ◆ Charge-discharge proof, polar
- ◆ Aluminum case with insulating sleeve
- ◆ Aluminum case designed explosion-proof vent
- ◆ Snap-in solder pins to hold component in place on PC-board

Specifications

Item	Performance Characteristics											
Operating Temperature Range	-40 to +85°C	-25 to +85°C										
Rated voltage V_R	10 to 450 V DC	500 V DC										
Surge voltage V_S	$V_R \leq 315V$ 1.15 V_R $V_R > 315V$ 1.10 V_R											
Rated capacitance C_R	47 to 100000 μF	47 to 1500 μF										
Capacitance tolerance	$\pm 20\%$ (120Hz,+20°C)											
Leakage Current I_{leak} (+20°C.max.)	$I \leq 3 \sqrt{CV}$ (μA)After 5minutes with rated working voltage applied											
Dissipation Factor ($\tan \delta$, at 20°C, 120Hz)	Less than the value under table(%)											
	$\mu F/Vdc$	6.3	10	16	25	35	50	63	80	100	160~420	450~600
	≤ 8200	-	35	35	30	25	20	20	15	15	15	20
	10000 to 22000	55	40	40	35	30	30	25	15	-	-	-
≥ 27000	60	50	40	35	35	30	25	-	-	-	-	
Self-inductance ESL	approx. 20 nH											
Useful life 85°C; $V_R, I_{AC,R}$ 85°C; $V_R, I_{AC,R}$	$V_R \leq 100V$:	Requirements:										
	$V_R > 100V$:	Requirements:										
Voltage Endurance test 85°C; V_R	5000 h	Post test requirements:					Post test requirements:					
		$V_R \leq 100V$					$V_R > 100V$					
Shelf Life 85°C	1000 h	Post test requirements:					Post test requirements:					
		$V_R \leq 100V$					$V_R > 100V$					
Vibration Resistance test	To IEC 60068-2-6, test Fc: Displacement amplitude 0.75 mm, frequency range 10 ... 55 Hz, acceleration max. 10 g, duration 3x2 h. Capacitor mounted by its body which is rigidly clamped to the work surface.											
Characteristics at low temperature	Max. impedance ratio at 120 Hz											
	$V_R(V)$	6.3	10	16	25	35~100	160~250	315~450	500~600			
	$Z_{-25^\circ C} / Z_{20^\circ C}$	5	5	5	4	4	4	8	8			
$Z_{-40^\circ C} / Z_{20^\circ C}$	15	15	15	15	12	7	10	-				
Sectional specification	IEC 60384-4 and JIS-C-5101											

Multiplier for Ripple Current vs. Frequency

$V_R(V)/$ Frequency(Hz)	50(60)	120	300	1K	10K	50K-100K
$10 \leq V_R \leq 100$	0.88	1	1.07	1.15	1.15	1.15
$160 \leq V_R \leq 250$	0.81	1	1.17	1.32	1.45	1.5
$315 \leq V_R \leq 600$	0.77	1	1.16	1.30	1.41	1.43

Dimensional drawings

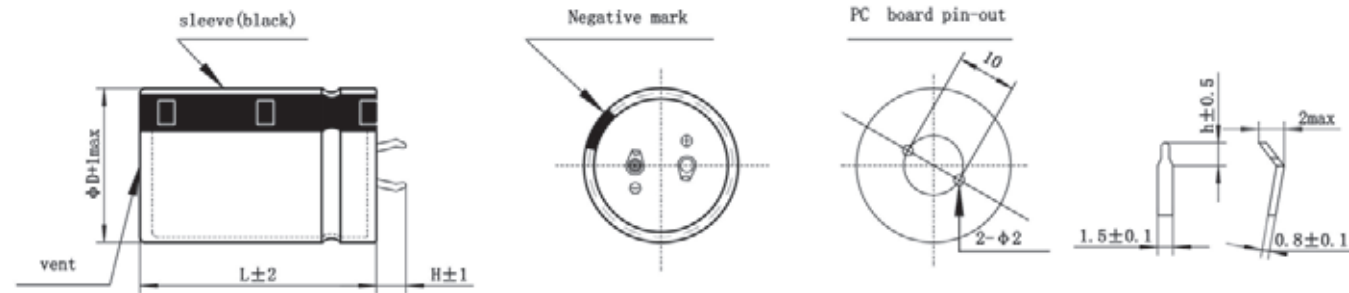

Standard snap-in terminals: length (6.0 ± 1) mm
 Also available with length of (4.0 ± 1) mm

H	h
6	2.5
4	1.5

Packing

Capacitor diameter D(mm)	Length L(mm)	Terminal length H(mm)	Each carton packing Qty units(pcs.)	Box/carton units(pcs.)	Each box packing Qty units(pcs.)
20	all	/	720	6	120
22	< 55	/	600	6	100
22	≥ 55	/	400	4	100
25	< 65	/	500	5	100
25	≥ 65	/	400	4	100
30	≤ 36	< $6(L=35, 36)$	400	8	50
30	$35 \leq L \leq 65$	$\geq 6(L=35, 36)$	300	6	50
30	> 65	/	200	4	50
35	≤ 25	/	400	8	50
35	$25 < L < 45$	/	300	6	50
35	$45 \leq L \leq 85$	/	200	4	50
35	> 85	/	100	2	50
40	35	< 6	200	5	40
40	35	≥ 6	160	4	40
40	$40 \leq L \leq 45$	/	160	4	40
40	$45 < L \leq 75$	/	120	3	40
40	> 75	/	80	2	40
45	$40 \leq L \leq 65$	/	140	4	35
45	$65 < L \leq 100$	/	70	2	35

Packing of snap-in



Case Size

WV (Vdc)	Cap (uF)	Size (mm)	Rated Ripple current (Arms/85°C /120Hz)	Typ. ESR 20°C 120Hz (mΩ)	MAX ESR 20°C 120Hz (mΩ)
10	10000	22x25	2.51	36	46
10	12000	22x25	2.71	34	44
10	15000	22x30	3.21	27	35
10	15000	25x25	3.21	27	35
10	18000	22x35	3.61	23	29
10	18000	25x30	3.61	23	29
10	22000	22x40	4.11	19	24
10	22000	25x35	4.11	19	24
10	22000	30x25	4.11	19	24
10	33000	22x45	4.81	15	20
10	33000	25x40	5.21	15	20
10	33000	30x30	5.21	15	20
10	47000	22x50	6.01	11	14
10	47000	25x45	6.31	11	14
10	47000	30x35	6.31	11	14
10	56000	30x40	7.21	9	12
10	56000	35x35	7.51	9	12
10	68000	30x50	8.21	8	10
10	68000	35x40	8.21	8	10
10	82000	35x50	9.31	6	8
10	100000	35x55	10.11	5	7
16	8200	22x25	2.21	44	57
16	10000	22x30	2.61	36	46
16	10000	25x25	2.61	36	46
16	12000	22x35	2.91	34	44
16	15000	22x40	3.31	27	35
16	15000	25x30	3.31	27	35
16	15000	30x25	3.41	27	35
16	18000	22x45	3.81	23	29
16	18000	25x35	3.71	23	29
16	22000	22x50	4.21	19	24
16	22000	25x40	4.21	19	24
16	22000	30x30	4.21	19	24
16	22000	35x25	4.41	19	24
16	33000	25x45	5.21	12	16
16	33000	30x35	5.21	12	16
16	33000	35x30	5.21	12	16
16	47000	25x50	6.31	9	11
16	47000	30x40	6.31	9	11
16	47000	35x35	6.31	9	11
16	56000	30x45	9.81	7	10
16	56000	35x40	9.81	7	10
16	56000	40x40	9.81	7	10
16	68000	35x50	10.81	6	8
16	68000	40x50	11.51	6	8
16	82000	35x60	11.81	5	7
16	82000	40x50	11.81	5	7
16	100000	35x80	13.21	4	6
16	100000	40x60	13.51	4	6
25	5600	22x25	2.01	55	71
25	6800	22x30	2.31	45	59
25	6800	25x25	2.31	45	59
25	8200	22x35	2.61	37	49
25	10000	22x40	2.91	31	40
25	10000	25x30	2.81	31	40
25	10000	30x25	3.01	31	40
25	12000	22x45	3.31	30	39
25	12000	25x35	3.21	30	39

WV (Vdc)	Cap (uF)	Size (mm)	Rated Ripple current (Arms/85°C /120Hz)	Typ. ESR 20°C 120Hz (mΩ)	MAX ESR 20°C 120Hz (mΩ)
25	12000	30x30	3.41	30	39
25	15000	25x40	3.71	24	31
25	15000	35x25	3.91	24	31
25	18000	25x50	4.31	20	26
25	18000	30x35	4.21	20	26
25	18000	35x30	4.41	20	26
25	22000	30x40	5.01	16	21
25	22000	35x35	5.01	16	21
25	33000	35x40	8.11	11	14
25	33000	40x40	8.71	11	14
25	39000	35x45	9.01	9	12
25	39000	40x40	9.61	9	12
25	47000	35x50	9.61	8	10
25	56000	35x60	10.31	6	8
25	56000	40x50	10.81	6	8
25	68000	35x80	11.31	5	7
25	68000	40x60	11.81	5	7
25	82000	40x80	13.51	4	6
35	3300	22x25	1.81	77	100
35	3900	22x30	2.11	65	85
35	4700	25x25	2.21	54	71
35	5600	22x35	2.31	46	59
35	5600	25x30	2.31	46	59
35	6800	22x40	2.91	38	49
35	6800	25x35	2.91	38	49
35	6800	30x25	2.91	38	49
35	8200	22x50	2.81	31	40
35	8200	25x40	2.81	31	40
35	8200	30x30	2.81	31	40
35	8200	35x25	2.91	31	40
35	10000	25x45	3.11	26	33
35	10000	30x35	3.21	26	33
35	12000	25x50	3.51	26	33
35	12000	30x40	3.51	26	33
35	12000	35x30	3.61	26	33
35	15000	30x45	4.11	20	27
35	15000	35x35	4.11	20	27
35	18000	30x50	4.61	17	22
35	18000	35x40	4.71	17	22
35	22000	35x45	5.31	14	18
35	27000	35x45	8.21	13	17
35	27000	40x40	8.21	13	17
35	33000	35x50	8.71	11	14
35	39000	35x60	10.31	9	12
35	39000	40x50	10.31	9	12
35	47000	35x80	11.41	8	10
35	47000	40x60	10.81	8	10
35	56000	40x70	12.11	6	8
35	68000	40x80	14.21	5	7
50	2200	22x25	1.71	92	120
50	2700	22x30	1.91	76	98
50	2700	25x25	1.91	76	98
50	3300	25x30	1.81	62	80
50	3900	22x35	2.11	52	68
50	3900	25x30	2.11	52	68
50	3900	30x25	2.41	52	68
50	4700	22x40	2.41	43	56
50	4700	25x35	2.41	43	56

WV (Vdc)	Cap (uF)	Size (mm)	Rated Ripple current (Arms/85°C /120Hz)	Typ. ESR 20°C 120Hz (mΩ)	MAX ESR 20°C 120Hz (mΩ)
50	5600	22x50	2.51	36	47
50	5600	25x40	2.51	36	47
50	5600	30x30	2.51	36	47
50	5600	35x25	2.61	36	47
50	6800	25x45	3.21	30	39
50	6800	30x35	3.21	30	39
50	8200	25x50	3.01	25	32
50	8200	30x40	3.01	25	32
50	8200	35x30	3.01	25	32
50	10000	30x45	3.41	20	27
50	10000	35x35	3.41	20	27
50	12000	30x45	3.81	26	33
50	12000	35x35	3.81	26	33
50	15000	30x50	4.51	20	27
50	15000	35x40	7.71	20	27
50	15000	40x40	8.11	20	27
50	18000	35x45	8.31	17	22
50	18000	40x40	8.31	17	22
50	22000	35x50	9.11	14	18
50	22000	40x50	9.41	14	18
50	27000	35x80	11.21	11	15
50	27000	40x60	10.81	11	15
50	33000	35x80	13.41	9	12
50	33000	40x70	13.41	9	12
50	39000	40x80	15.51	8	10
63	1500	22x25	1.61	140	180
63	1800	22x25	1.81	120	150
63	2200	22x30	2.01	92	120
63	2200	25x25	2.01	92	120
63	2700	22x35	2.21	76	98
63	2700	25x30	2.31	76	98
63	3300	22x40	2.31	62	80
63	3300	25x35	2.31	62	80
63	3300	30x25	2.31	62	80
63	3900	22x45	2.51	52	68
63	3900	25x40	2.61	52	68
63	3900	30x30	2.61	52	68
63	3900	35x25	2.71	52	68
63	4700	30x30	2.91	43	56
63	5600	25x45	3.11	36	47
63	5600	30x35	3.21	36	47
63	5600	35x30	3.31	36	47
63	6800	30x40	3.61	30	39
63	6800	35x35	3.71	30	39
63	8200	30x50	3.71	25	32
63	8200	35x40	3.81	25	32
63	10000	35x45	4.31	20	27
63	12000	35x50	4.81	21	28
63	12000	35x50	8.71	21	28
63	12000	40x40	8.61	21	28
63	15000	35x70	10.21	17	22
63	15000	40x50	9.51	17	22
63	18000	35x80	11.21	14	18
63	18000	40x60	10.71	14	18
63	27000	40x80	12.71	9	12
80	1000	22x25	1.31	150	200
80	1200	22x30	1.51	130	170
80	1500	25x25	1.71	100	130
80	1800	22x35	1.91	85	110
80	1800	25x30	1.91	85	110

WV (Vdc)	Cap (uF)	Size (mm)	Rated Ripple current (Arms/85°C /120Hz)	Typ. ESR 20°C 120Hz (mΩ)	MAX ESR 20°C 120Hz (mΩ)
80	2200	22x40	2.11	70	90
80	2200	25x35	2.21	70	90
80	2200	30x25	2.21	70	90
80	2700	22x50	2.51	57	74
80	2700	25x40	2.51	57	74
80	2700	30x30	2.51	57	74
80	2700	35x25	2.51	57	74
80	3300	25x45	2.81	46	60
80	3300	30x35	2.81	46	60
80	3900	25x50	3.11	39	51
80	3900	30x40	3.21	39	51
80	3900	35x30	3.21	39	51
80	4700	30x45	3.61	33	42
80	4700	35x35	3.61	33	42
80	5600	30x50	3.81	27	36
80	5600	35x40	3.81	27	36
80	6800	35x50	4.11	23	29
80	8200	35x50	6.91	19	24
80	10000	35x60	8.71	15	20
80	12000	35x70	9.71	13	17
80	12000	40x50	9.01	13	17
80	15000	35x80	10.51	10	13
80	15000	40x60	10.21	10	13
80	18000	40x80	12.31	9	11
100	680	22x25	1.11	220	290
100	820	22x30	1.21	180	240
100	1000	25x25	1.41	150	200
100	1200	22x35	1.61	130	170
100	1200	25x30	1.61	130	170
100	1500	22x40	1.81	100	130
100	1500	25x35	1.81	100	130
100	1500	30x25	1.81	100	130
100	1800	22x50	2.11	85	110
100	1800	25x40	2.01	85	110
100	1800	30x30	2.11	85	110
100	1800	35x25	2.21	85	110
100	2200	25x45	2.21	70	90
100	2200	30x35	2.31	70	90
100	2200	35x30	2.51	70	90
100	2700	25x50	2.61	57	74
100	2700	30x40	2.71	57	74
100	3300	30x45	3.01	46	60
100	3300	35x35	3.11	46	60
100	3900	30x45	3.41	39	51
100	3900	35x35	3.41	39	51
100	4700	35x40	4.01	33	42
100	5600	35x45	7.01	27	36
100	5600	40x40	7.41	27	36
100	6800	35x50	8.01	23	29
100	6800	40x50	8.91	23	29
100	8200	35x70	9.61	19	24
100	8200	40x60	9.61	19	24
100	10000	35x80	10.41	15	20
100	10000	40x60	10.21	15	20
100	12000	40x80	12.31	13	17
160	220	22x20	1.01	500	900
160	270	22x25	1.11	410	740
160	330	22x25	1.51	330	600
160	390	22x30	1.51	280	510
160	390	25x25	1.61	280	510

WV (Vdc)	Cap (uF)	Size (mm)	Rated Ripple current (Arms/85°C /120Hz)	Typ. ESR 20°C 120Hz (mΩ)	MAX ESR 20°C 120Hz (mΩ)
160	470	22x35	1.81	230	420
160	470	25x25	1.71	230	420
160	560	22x35	2.11	200	360
160	560	25x30	2.21	200	360
160	560	30x25	2.11	200	360
160	680	22x40	2.31	160	290
160	680	25x35	2.31	160	290
160	820	22x50	2.71	130	240
160	820	25x40	2.71	130	240
160	820	30x30	2.71	130	240
160	820	35x25	2.71	130	240
160	1000	25x45	3.31	110	200
160	1000	30x35	3.41	110	200
160	1000	35x30	3.41	110	200
160	1200	25x50	3.71	94	170
160	1200	30x40	3.81	94	170
160	1200	35x35	3.81	94	170
160	1500	30x45	4.41	72	130
160	1500	35x40	4.41	72	130
160	1800	35x40	4.41	61	110
160	2200	35x45	4.91	50	90
160	2700	35x50	5.31	41	74
160	3300	35x70	5.51	33	60
160	3300	40x60	5.51	33	60
160	3900	35x80	5.91	28	51
160	4700	40x80	7.31	24	42
180	270	22x25	1.21	410	740
180	330	22x30	1.51	330	600
180	390	25x25	1.68	280	510
180	470	22x35	1.71	230	420
180	470	25x30	1.71	230	420
180	470	30x25	1.81	230	420
180	560	22x40	2.12	200	360
180	560	25x35	2.12	200	360
180	680	22x50	2.41	160	290
180	680	25x40	2.41	160	290
180	680	30x30	2.41	160	290
180	680	35x25	2.41	160	290
180	820	25x45	2.71	130	240
180	820	30x35	2.71	130	240
180	820	35x30	2.71	130	240
180	1000	25x50	3.51	110	200
180	1000	30x40	3.51	110	200
180	1200	30x45	3.92	94	170
180	1200	35x35	3.92	94	170
180	1500	35x45	4.61	72	130
180	1800	35x50	4.11	61	110
200	220	22x25	1.21	500	900
200	270	22x25	1.32	410	740
200	330	22x25	1.54	330	600
200	330	22x30	1.61	330	600
200	330	25x25	1.64	330	600
200	390	22x30	1.75	280	510
200	390	25x25	1.68	280	510
200	390	25x30	1.87	280	510
200	390	30x25	2.06	280	510
200	470	22x30	1.95	230	420
200	470	22x35	2.00	230	420
200	470	25x25	1.95	230	420
200	470	25x30	2.05	230	420

WV (Vdc)	Cap (uF)	Size (mm)	Rated Ripple current (Arms/85°C /120Hz)	Typ. ESR 20°C 120Hz (mΩ)	MAX ESR 20°C 120Hz (mΩ)
200	470	30x25	2.28	230	420
200	560	22x35	2.25	200	360
200	560	22x40	2.32	200	360
200	560	25x30	2.24	200	360
200	560	25x35	2.34	200	360
200	560	30x25	2.34	200	360
200	560	30x30	2.59	200	360
200	560	35x25	2.58	200	360
200	680	22x40	2.60	160	290
200	680	22x45	2.57	160	290
200	680	25x35	2.49	160	290
200	680	25x40	2.68	160	290
200	680	30x25	2.42	160	290
200	680	30x30	2.87	160	290
200	680	35x25	2.90	160	290
200	820	22x45	2.99	130	240
200	820	25x35	2.76	130	240
200	820	25x40	2.99	130	240
200	820	25x45	3.06	130	240
200	820	30x30	2.99	130	240
200	820	30x35	3.28	130	240
200	820	35x25	3.06	130	240
200	820	35x30	3.30	130	240
200	1000	25x45	3.63	110	200
200	1000	25x50	3.80	110	200
200	1000	30x30	3.51	110	200
200	1000	30x35	3.63	110	200
200	1000	30x40	4.00	110	200
200	1000	35x25	3.51	110	200
200	1000	35x30	4.10	110	200
200	1200	25x50	4.03	94	170
200	1200	30x45	4.53	94	170
200	1200	35x35	4.53	94	170
200	1500	30x50	5.26	72	130
200	1500	35x35	4.80	72	130
200	1500	35x40	5.26	72	130
200	1800	30x50	5.31	61	110
200	1800	30x55	5.67	61	110
200	1800	35x40	5.31	61	110
200	1800	35x45	5.77	61	110
200	2200	35x45	5.81	50	90
200	2200	35x50	5.91	50	90
200	2700	35x55	6.03	41	74
200	2700	35x60	6.19	41	74
200	2700	40x50	6.19	41	74
200	3300	35x80	7.50	33	60
200	3300	40x60	7.50	33	60
200	3900	40x80	8.00	28	51
250	100	22x25	0.73	1110	1990
250	150	22x25	0.93	740	1330
250	180	22x25	1.12	620	1110
250	220	22x30	1.29	500	900
250	220	25x25	1.29	500	900
250	270	22x30	1.47	410	740
250	270	25x25	1.54	410	740
250	330	22x30	1.67	330	600
250	330	22x35	1.70	330	600
250	330	25x25	1.63	330	600
250	330	25x30	1.79	330	600
250	390	22x35	1.91	280	510

WV (Vdc)	Cap (uF)	Size (mm)	Rated Ripple current (Arms/85°C /120Hz)	Typ. ESR 20°C 120Hz (mΩ)	MAX ESR 20°C 120Hz (mΩ)
250	390	22x40	1.94	280	510
250	390	25x30	1.86	280	510
250	390	25x35	2.02	280	510
250	390	30x25	2.15	280	510
250	470	22x40	2.19	230	420
250	470	22x45	2.22	230	420
250	470	25x30	2.06	230	420
250	470	25x35	2.23	230	420
250	470	30x30	2.45	230	420
250	560	22x40	2.46	200	360
250	560	22x50	2.54	200	360
250	560	25x35	2.46	200	360
250	560	25x40	2.53	200	360
250	560	30x30	2.70	200	360
250	560	35x25	2.73	200	360
250	680	22x50	2.90	160	290
250	680	25x40	2.72	160	290
250	680	25x45	2.90	160	290
250	680	30x35	3.09	160	290
250	680	35x25	2.90	160	290
250	680	35x30	3.35	160	290
250	820	25x45	3.28	130	240
250	820	25x50	3.36	130	240
250	820	25x55	3.48	130	240
250	820	30x35	3.30	130	240
250	820	30x40	3.39	130	240
250	820	35x30	3.44	130	240
250	820	35x35	3.81	130	240
250	1000	25x50	3.80	110	200
250	1000	30x40	4.00	110	200
250	1000	30x45	4.29	110	200
250	1000	35x30	4.10	110	200
250	1000	35x35	4.29	110	200
250	1000	35x40	4.38	110	200
250	1200	30x45	4.62	94	170
250	1200	30x50	4.74	94	170
250	1200	35x35	4.62	94	170
250	1200	35x40	4.76	94	170
250	1500	35x40	5.38	72	130
250	1500	35x45	5.48	72	130
250	1800	35x45	5.78	61	110
250	1800	35x55	6.35	61	110
250	2200	35x55	6.45	50	90
250	2200	35x65	6.80	50	90
315	100	22x25	0.73	1110	1990
315	120	22x30	0.76	920	1660
315	150	22x30	0.94	740	1330
315	150	25x25	0.94	740	1330
315	180	22x35	1.12	620	1110
315	180	25x30	1.12	620	1110
315	220	22x40	1.32	500	900
315	220	25x35	1.32	500	900
315	220	30x25	1.32	500	900
315	270	22x45	1.61	410	740
315	270	25x40	1.61	410	740
315	270	30x30	1.61	410	740
315	270	35x25	1.61	410	740
315	330	25x45	1.76	330	600
315	330	30x35	1.76	330	600
315	390	25x50	2.21	280	510

WV (Vdc)	Cap (uF)	Size (mm)	Rated Ripple current (Arms/85°C /120Hz)	Typ. ESR 20°C 120Hz (mΩ)	MAX ESR 20°C 120Hz (mΩ)
315	390	30x40	2.21	280	510
315	390	35x30	2.21	280	510
315	470	30x45	2.45	230	420
315	470	35x35	2.45	230	420
315	560	30x50	2.85	200	360
315	560	35x40	2.85	200	360
315	680	35x45	2.31	160	290
350	82	22x25	0.65	1350	2430
350	100	22x25	0.73	1110	1990
350	120	22x30	0.83	920	1660
350	120	25x25	0.83	920	1660
350	150	22x35	0.95	740	1330
350	150	25x30	0.95	740	1330
350	180	22x40	1.12	620	1110
350	180	30x25	1.12	620	1110
350	220	22x45	1.42	500	900
350	220	25x35	1.42	500	900
350	220	30x30	1.42	500	900
350	220	35x25	1.51	500	900
350	270	25x40	1.72	410	740
350	270	30x35	1.72	410	740
350	330	25x45	1.83	330	600
350	330	30x40	1.83	330	600
350	330	35x30	1.83	330	600
350	390	30x40	2.34	280	510
350	390	35x35	2.34	280	510
350	470	30x45	2.49	230	420
350	470	35x40	2.49	230	420
350	560	35x45	3.22	200	360
350	680	35x45	3.70	160	290
350	820	35x50	4.50	130	240
350	1000	35x55	5.20	110	200
350	1200	35x60	5.50	94	170
350	1200	40x50	5.60	94	170
350	1500	40x60	8.50	72	130
350	1800	40x70	7.90	61	110
350	2200	40x80	8.70	50	90
400	68	22x25	0.63	1630	2930
400	82	22x25	0.79	1350	2430
400	100	22x25	0.87	1110	1990
400	100	22x30	0.91	1110	1990
400	100	25x25	1.05	1110	1990
400	120	22x30	0.99	920	1660
400	120	22x35	1.10	920	1660
400	120	25x25	1.10	920	1660
400	120	25x30	1.20	920	1660
400	150	22x30	1.15	740	1330
400	150	22x35	1.19	740	1330
400	150	25x25	1.15	740	1330
400	150	25x30	1.22	740	1330
400	150	30x25	1.24	740	1330
400	180	22x35	1.31	620	1110
400	180	22x40	1.37	620	1110
400	180	25x30	1.30	620	1110
400	180	25x35	1.46	620	1110
400	180	30x30	1.46	620	1110
400	220	22x40	1.53	500	900
400	220	22x50	1.76	500	900
400	220	25x35	1.50	500	900
400	220	25x40	1.76	500	900

WV (Vdc)	Cap (uF)	Size (mm)	Rated Ripple current (Arms/85°C /120Hz)	Typ. ESR 20°C 120Hz (mΩ)	MAX ESR 20°C 120Hz (mΩ)
400	220	30x25	1.53	500	900
400	220	30x30	1.78	500	900
400	220	35x25	1.81	500	900
400	220	35x30	1.86	500	900
400	270	22x45	1.79	410	740
400	270	25x40	1.83	410	740
400	270	25x45	1.97	410	740
400	270	30x30	1.89	410	740
400	270	30x35	2.04	410	740
400	270	35x25	2.17	410	740
400	270	35x30	2.04	410	740
400	330	25x45	2.03	330	600
400	330	25x50	2.20	330	600
400	330	30x35	2.15	330	600
400	330	30x40	2.47	330	600
400	330	35x30	2.37	330	600
400	390	25x50	2.33	280	510
400	390	30x35	2.35	280	510
400	390	30x45	2.59	280	510
400	390	35x30	2.32	280	510
400	390	35x35	2.55	280	510
400	470	25x55	2.66	230	420
400	470	30x40	2.61	230	420
400	470	30x50	2.75	230	420
400	470	35x35	2.58	230	420
400	470	35x40	2.79	230	420
400	560	30x55	3.36	200	360
400	560	35x35	3.15	200	360
400	560	35x45	3.43	200	360
400	560	40x40	3.48	200	360
400	680	30x55	3.50	160	290
400	680	35x40	3.85	160	290
400	680	35x50	3.93	160	290
400	680	35x55	4.16	160	290
400	680	40x50	4.38	160	290
400	820	35x50	4.50	130	240
400	820	35x55	4.60	130	240
400	820	40x50	4.60	130	240
400	1000	35x65	5.20	110	200
400	1000	40x60	5.30	110	200
400	1000	45x50	5.30	110	200
400	1200	35x70	5.90	94	170
400	1200	40x60	5.90	94	170
400	1500	40x70	6.70	72	130
400	1800	45x80	7.40	61	110
420	100	22x30	1.08	1470	2650
420	100	25x25	1.08	1470	2650
420	120	25x30	1.23	1230	2210
420	150	22x40	1.19	980	1770
420	150	25x35	1.24	980	1770
420	180	25x35	1.46	820	1470
420	180	30x30	1.46	820	1470
420	220	25x40	1.82	670	1210
420	220	30x35	1.87	670	1210
420	270	25x55	2.07	540	980
420	270	30x35	2.07	540	980
420	270	35x30	2.07	540	980
420	330	30x45	2.40	440	800
420	330	35x35	2.40	440	800
420	390	30x50	2.66	380	680

WV (Vdc)	Cap (uF)	Size (mm)	Rated Ripple current (Arms/85°C /120Hz)	Typ. ESR 20°C 120Hz (mΩ)	MAX ESR 20°C 120Hz (mΩ)
420	470	30x55	2.84	310	560
420	470	35x45	2.89	310	560
420	560	35x50	3.45	260	470
420	680	35x60	4.01	220	390
420	820	35x65	4.61	180	320
420	1000	35x80	5.61	150	270
420	1500	40x80	7.21	100	180
420	1800	45x80	7.81	83	150
450	47	22x25	0.53	3130	5640
450	56	22x25	0.61	2630	4740
450	68	22x30	0.69	2170	3900
450	68	25x25	0.72	2170	3900
450	82	25x25	0.82	1790	3230
450	82	25x30	0.93	1790	3230
450	100	22x35	1.10	1470	2650
450	100	25x30	1.12	1470	2650
450	100	30x25	1.13	1470	2650
450	120	22x40	1.24	1230	2210
450	120	25x30	1.24	1230	2210
450	120	30x25	1.24	1230	2210
450	150	22x45	1.33	980	1770
450	150	25x30	1.20	980	1770
450	150	25x35	1.30	980	1770
450	150	30x30	1.36	980	1770
450	150	35x25	1.43	980	1770
450	180	25x35	1.46	820	1470
450	180	25x40	1.48	820	1470
450	180	30x35	1.70	820	1470
450	180	35x25	1.55	820	1470
450	180	35x30	1.72	820	1470
450	220	22x50	1.84	670	1210
450	220	25x40	1.82	670	1210
450	220	25x50	1.93	670	1210
450	220	30x35	1.87	670	1210
450	220	30x40	1.93	670	1210
450	220	35x25	1.88	670	1210
450	220	35x30	1.94	670	1210
450	270	25x45	2.11	540	980
450	270	25x55	2.22	540	980
450	270	30x35	2.10	540	980
450	270	30x40	2.22	540	980
450	270	35x30	2.05	540	980
450	270	35x35	2.22	540	980
450	330	25x50	2.24	440	800
450	330	30x40	2.24	440	800
450	330	30x45	2.40	440	800
450	330	35x30	2.35	440	800
450	330	35x40	2.53	440	800
450	390	30x45	2.64	380	680
450	390	30x55	2.74	380	680
450	390	35x35	2.63	380	680
450	390	35x45	2.83	380	680
450	470	30x50	2.75	310	560
450	470	35x40	2.79	310	560
450	470	35x50	3.22	310	560
450	470	40x40	3.22	310	560
450	560	30x55	3.63	260	470
450	560	35x45	3.43	260	470
450	560	35x55	3.63	260	470
450	560	40x50	3.63	260	470

WV (Vdc)	Cap (uF)	Size (mm)	Rated Ripple current (Arms/85°C /120Hz)	Typ. ESR 20°C 120Hz (mΩ)	MAX ESR 20°C 120Hz (mΩ)
450	680	35x50	3.49	220	390
450	680	35x60	3.52	220	390
450	680	40x50	3.51	220	390
450	820	35x65	4.61	180	320
450	820	40x55	4.61	180	320
450	1000	35x70	5.71	150	270
450	1000	40x60	5.21	150	270
450	1200	35x80	5.91	120	220
450	1200	40x65	5.91	120	220
450	1500	40x80	7.31	100	180
450	1800	45x80	7.91	83	150
500	47	22x25	0.56	3130	5640
500	56	25x25	0.62	2630	4740
500	68	22x30	0.70	2170	3900
500	68	25x25	0.75	2170	3900
500	82	25x30	0.83	1790	3230
500	100	25x30	0.96	1470	2650
500	100	30x25	0.99	1470	2650
500	120	25x35	1.12	1230	2210
500	120	30x30	1.13	1230	2210
500	120	35x25	1.15	1230	2210
500	150	25x40	1.30	980	1770
500	150	30x30	1.32	980	1770

WV (Vdc)	Cap (uF)	Size (mm)	Rated Ripple current (Arms/85°C /120Hz)	Typ. ESR 20°C 120Hz (mΩ)	MAX ESR 20°C 120Hz (mΩ)
500	150	35x25	1.36	980	1770
500	180	25x45	1.58	820	1470
500	180	30x35	1.60	820	1470
500	180	35x30	1.63	820	1470
500	220	25x55	1.76	670	1210
500	220	30x40	1.73	670	1210
500	220	35x35	1.80	670	1210
500	270	30x45	2.15	540	980
500	270	35x35	2.15	540	980
500	330	30x50	2.41	440	800
500	330	35x40	2.32	440	800
500	390	35x45	2.71	380	680
500	470	35x55	2.99	310	560
500	560	35x60	3.11	260	470
500	560	40x50	3.13	260	470
500	680	35x70	3.21	220	390
500	680	40x60	3.22	220	390
500	820	35x80	4.61	180	320
500	820	40x70	4.43	180	320
500	1000	40x80	5.91	150	270
500	1200	40x80	5.98	120	220
500	1500	40x100	6.31	100	180

Useful life

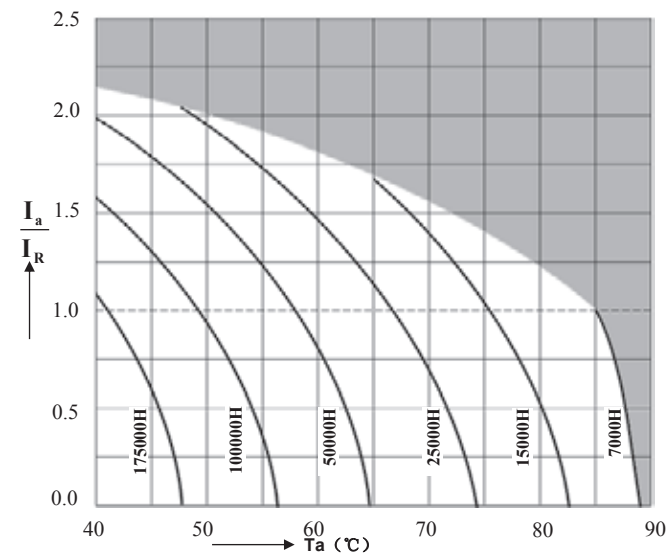

depending on ambient temperature T_a versus under ripple current operating conditions $VR \leq 100V$

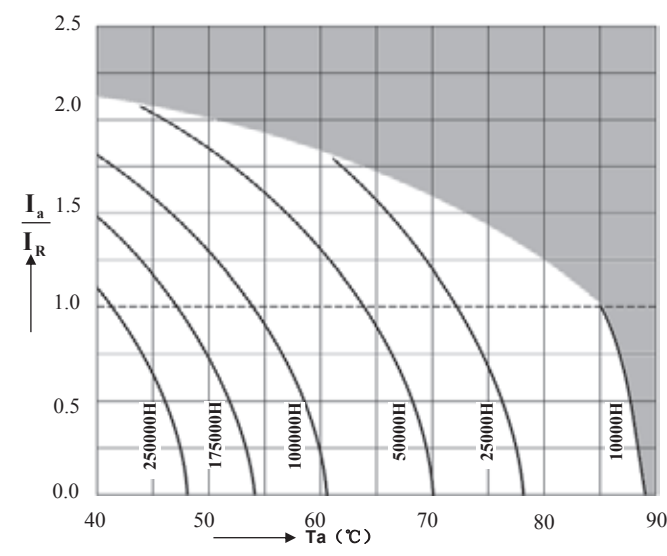

depending on ambient temperature T_a versus under ripple current operating conditions $VR \geq 160V$

HP Series 105°C 2000H



Features

Standard capacitors

Applications

- ◆ Switch-mode power supplies in industrial and entertainment electronics
- ◆ Uninterruptible power supplies

Features

- ◆ High reliability
- ◆ Long useful life
- ◆ High ripple current capability
- ◆ Aluminum case designed explosion-proof vent
- ◆ RoHS-compatible

Construction

- ◆ Charge-discharge proof, polar
- ◆ Aluminum case with insulating sleeve
- ◆ Aluminum case designed explosion-proof vent
- ◆ Snap-in solder pins to hold component in place on PC-board

Specifications

Item	Performance Characteristics											
Operating Temperature Range	-40 to +105°C	-25 to +105°C										
Rated voltage V_R	6.3 to 450 V DC	500 to 550 V DC										
Surge voltage V_S	$V_R \leq 315V$ 1.15 V_R $V_R > 315V$ 1.10 V_R											
Rated capacitance C_R	56 to 100000 μF	47 to 1000 μF										
Capacitance tolerance	$\pm 20\%$ (120Hz,+20°C)											
Leakage Current I_{leak} (+20°C.max.)	$I \leq 3 \sqrt{CV}$ (μA)After 5minutes with rated working voltage applied											
Dissipation Factor (tan δ , at 20°C, 120Hz)	Less than the value under table(%)											
	$\mu F/Vdc$	6.3	10	16	25	35	50	63	80	100	160~420	450~600
	≤ 8200	-	35	35	30	25	20	20	15	15	15	20
	10000 to 22000	55	40	40	35	30	30	25	15	-	-	-
≥ 27000	60	50	40	35	35	30	25	-	-	-	-	
Self-inductance ESL	approx. 20 nH											
Useful life 105°C; $V_R, I_{AC,R}$ 105°C; $V_R, I_{AC,R}$	$V_R \leq 100V$:	Requirements:										
	$V_R > 100V$:	Requirements:										
Voltage Endurance test 105°C; V_R	2000 h	$V_R \leq 100V$					$V_R > 100V$					
		DC/C	$\leq \pm 30\%$ of initial value					DC/C	$\leq \pm 20\%$ of initial value			
Shelf Life 105°C	1000 h	$V_R \leq 100V$					$V_R > 100V$					
		DC/C	$\leq \pm 15\%$ of initial value					DC/C	$\leq \pm 10\%$ of initial value			
Vibration Resistance test	2000 h	Post test requirements:										
		ESR	≤ 1.3 times initial specified limit					ESR	≤ 1.3 times initial specified limit			
Characteristics at low temperature	1000 h	Post test requirements:										
		ESR	≤ 1.3 times initial specified limit					ESR	≤ 1.3 times initial specified limit			
Characteristics at low temperature	1000 h	To IEC 60068-2-6, test Fc:										
		Displacement amplitude 0.75 mm, frequency range 10 ... 55 Hz, acceleration max. 10 g, duration 3x2 h. Capacitor mounted by its body which is rigidly clamped to the work surface.										
Characteristics at low temperature	1000 h	Max. impedance ratio at 120 Hz										
		$V_R(V)$	6.3~16	25	35	50~100	160~250	315~450	500			
		$Z_{-25^\circ C} / Z_{20^\circ C}$	4	3	3	3	3	8	8			
		$Z_{-40^\circ C} / Z_{20^\circ C}$	15	10	8	6	7	10	-			
Sectional specification	IEC 60384-4 and JIS-C-5101											

Multiplier for Ripple Current vs. Frequency

$V_R(V)/$ Frequency(Hz)	50(60)	120	300	1K	10K	50K-100K
$10 \leq V_R \leq 100$	0.88	1	1.07	1.15	1.15	1.15
$160 \leq V_R \leq 250$	0.81	1	1.17	1.32	1.45	1.5
$315 \leq V_R \leq 600$	0.77	1	1.16	1.30	1.41	1.43

Dimensional drawings

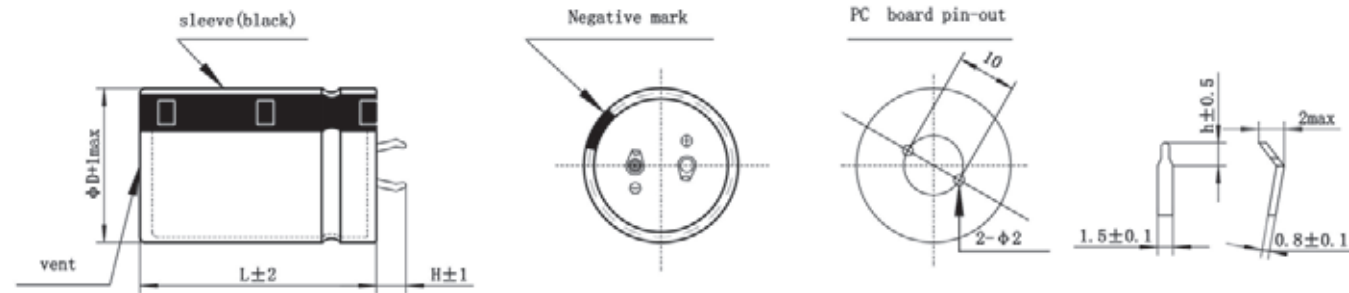

Standard snap-in terminals: length (6.0 ± 1) mm
 Also available with length of (4.0 ± 1) mm

H	h
6	2.5
4	1.5

Packing

Capacitor diameter D(mm)	Length L(mm)	Terminal length H(mm)	Each carton packing Qty units(pcs.)	Box/carton units(pcs.)	Each box packing Qty units(pcs.)
20	all	/	720	6	120
22	< 55	/	600	6	100
22	≥ 55	/	400	4	100
25	< 65	/	500	5	100
25	≥ 65	/	400	4	100
30	≤ 36	< $6(L=35, 36)$	400	8	50
30	$35 \leq L \leq 65$	$\geq 6(L=35, 36)$	300	6	50
30	> 65	/	200	4	50
35	≤ 25	/	400	8	50
35	$25 < L < 45$	/	300	6	50
35	$45 \leq L \leq 85$	/	200	4	50
35	> 85	/	100	2	50
40	35	< 6	200	5	40
40	35	≥ 6	160	4	40
40	$40 \leq L \leq 45$	/	160	4	40
40	$45 < L \leq 75$	/	120	3	40
40	> 75	/	80	2	40
45	$40 \leq L \leq 65$	/	140	4	35
45	$65 < L \leq 100$	/	70	2	35

Packing of snap-in



Case Size

WV (Vdc)	Cap (uF)	Size (mm)	Rated Ripple current (Arms/105°C /120Hz)	Typ. ESR 20°C 120Hz (mΩ)	MAX ESR 20°C 120Hz (mΩ)
6.3	12000	22x25	1.54	47	61
6.3	15000	22x25	1.72	37	49
6.3	18000	22x30	1.95	31	41
6.3	18000	25x25	1.96	31	41
6.3	22000	22x35	2.23	26	33
6.3	22000	25x30	2.25	26	33
6.3	22000	30x25	2.28	26	33
6.3	27000	22x40	2.54	23	29
6.3	27000	25x35	2.57	23	29
6.3	27000	30x25	2.59	23	29
6.3	33000	22x45	2.88	19	24
6.3	33000	25x40	2.93	19	24
6.3	33000	30x30	2.89	19	24
6.3	33000	35x25	2.93	19	24
6.3	39000	25x40	3.18	16	20
6.3	39000	30x35	3.26	16	20
6.3	39000	35x30	3.40	16	20
6.3	47000	25x50	3.69	13	17
6.3	47000	30x40	3.69	13	17
6.3	47000	35x30	3.73	13	17
6.3	56000	30x45	4.16	11	14
6.3	56000	35x35	4.17	11	14
6.3	68000	30x50	4.71	9	12
6.3	68000	35x40	4.71	9	12
6.3	82000	35x45	5.32	8	10
10	4700	22x25	1.24	76	99
10	6800	22x25	1.40	53	68
10	8200	22x25	1.65	44	57
10	10000	22x25	1.90	36	46
10	12000	22x30	2.48	34	44
10	12000	25x25	2.48	34	44
10	15000	22x35	2.71	27	35
10	15000	25x25	2.60	27	35
10	18000	22x35	2.89	23	29
10	18000	25x30	2.94	23	29
10	18000	30x25	2.94	23	29
10	22000	22x40	2.96	19	24
10	22000	25x30	2.96	19	24
10	22000	30x25	3.08	19	24
10	27000	22x50	3.12	19	25
10	27000	25x40	3.12	19	25
10	27000	30x30	3.13	19	25
10	27000	35x25	3.21	19	25
10	33000	25x45	3.32	15	20
10	33000	35x30	3.85	15	20
10	39000	30x40	3.85	13	17
10	47000	30x45	3.98	11	14
10	47000	35x35	4.05	11	14
10	56000	30x50	4.21	9	12
10	56000	35x40	4.32	9	12
10	68000	35x45	5.12	8	10
10	100000	35x50	6.14	5	7
16	4700	22x25	1.55	76	99
16	6800	22x25	1.78	53	68
16	8200	22x25	2.14	44	57
16	10000	22x30	2.48	36	46
16	10000	25x25	2.56	36	46
16	12000	22x35	2.80	34	44

WV (Vdc)	Cap (uF)	Size (mm)	Rated Ripple current (Arms/105°C /120Hz)	Typ. ESR 20°C 120Hz (mΩ)	MAX ESR 20°C 120Hz (mΩ)
16	12000	25x30	2.90	34	44
16	12000	30x25	2.97	34	44
16	15000	22x40	3.17	27	35
16	15000	25x35	3.29	27	35
16	15000	30x30	3.38	27	35
16	18000	22x45	3.50	23	29
16	18000	25x40	3.65	23	29
16	18000	30x30	3.65	23	29
16	22000	22x45	3.65	19	24
16	22000	25x40	3.71	19	24
16	22000	30x35	3.83	19	24
16	27000	25x40	3.95	15	20
16	27000	30x35	3.96	15	20
16	33000	25x45	4.32	12	16
16	33000	30x35	4.41	12	16
16	33000	35x30	4.43	12	16
16	39000	30x40	4.90	10	14
16	39000	35x35	5.10	10	14
16	47000	30x45	5.30	9	11
16	47000	35x40	5.52	9	11
16	56000	30x50	6.00	7	10
16	56000	35x40	6.05	7	10
16	68000	35x50	6.40	6	8
25	2200	22x25	1.03	140	180
25	3300	22x25	1.48	92	120
25	4700	22x25	1.73	65	85
25	5600	22x25	1.85	55	71
25	6800	22x30	2.05	45	59
25	6800	25x25	2.10	45	59
25	8200	22x30	2.31	37	49
25	8200	25x25	2.31	37	49
25	10000	22x35	2.65	31	40
25	10000	25x30	2.68	31	40
25	12000	22x40	2.92	30	39
25	12000	25x30	2.91	30	39
25	12000	30x25	2.93	30	39
25	15000	22x45	3.18	24	31
25	15000	25x35	3.10	24	31
25	15000	30x30	3.32	24	31
25	18000	22x45	3.51	20	26
25	18000	25x40	3.60	20	26
25	18000	30x30	3.80	20	26
25	22000	25x45	4.04	16	21
25	22000	30x35	4.04	16	21
25	22000	35x30	4.04	16	21
25	27000	30x40	4.74	13	17
25	27000	35x35	4.76	13	17
25	33000	30x45	5.50	11	14
25	33000	35x40	5.70	11	14
25	39000	35x45	5.80	9	12
25	47000	35x50	6.30	8	10
35	1500	22x25	1.26	170	220
35	2200	22x25	1.35	120	150
35	2700	22x25	1.36	92	120
35	3300	22x25	1.49	77	100
35	3900	22x30	1.82	65	85
35	4700	22x30	2.02	54	71
35	4700	25x25	2.12	54	71

WV (Vdc)	Cap (uF)	Size (mm)	Rated Ripple current (Arms/105°C /120Hz)	Typ. ESR 20°C 120Hz (mΩ)	MAX ESR 20°C 120Hz (mΩ)
35	5600	22x30	2.25	46	59
35	5600	25x25	2.35	46	59
35	6800	22x35	2.36	38	49
35	6800	25x30	2.41	38	49
35	6800	30x25	2.50	38	49
35	8200	22x40	2.55	31	40
35	8200	25x35	2.61	31	40
35	8200	30x25	2.65	31	40
35	10000	22x40	3.00	26	33
35	10000	25x35	3.15	26	33
35	10000	30x30	3.35	26	33
35	12000	22x45	3.47	26	33
35	12000	25x40	3.50	26	33
35	12000	30x35	3.52	26	33
35	12000	35x30	3.58	26	33
35	15000	25x45	3.65	20	27
35	15000	30x40	3.69	20	27
35	15000	35x35	3.75	20	27
35	18000	25x50	3.82	17	22
35	18000	30x40	3.95	17	22
35	18000	35x35	4.12	17	22
35	22000	30x45	4.38	14	18
35	22000	35x40	4.78	14	18
35	27000	30x50	4.86	13	17
35	27000	35x45	5.12	13	17
35	33000	35x50	5.90	11	14
50	1000	22x25	0.84	210	270
50	1500	22x25	1.27	140	180
50	1800	22x25	1.35	120	150
50	2200	22x25	1.48	92	120
50	2700	22x25	1.68	76	98
50	3300	22x30	1.75	62	80
50	3300	25x25	1.87	62	80
50	3900	22x30	2.12	52	68
50	3900	25x25	2.21	52	68
50	4700	22x35	2.25	43	56
50	4700	25x30	2.31	43	56
50	4700	30x25	2.33	43	56
50	5600	22x40	2.49	36	47
50	5600	25x35	2.76	36	47
50	5600	30x30	2.85	36	47
50	6800	22x50	3.10	30	39
50	6800	25x40	3.05	30	39
50	6800	30x35	3.34	30	39
50	6800	35x30	3.42	30	39
50	8200	25x45	3.48	25	32
50	8200	30x35	3.51	25	32
50	8200	35x30	3.60	25	32
50	10000	25x50	3.91	20	27
50	10000	30x40	3.98	20	27
50	10000	35x30	4.05	20	27
50	12000	30x45	4.31	26	33
50	12000	35x35	4.38	26	33
50	15000	35x50	4.80	20	27
50	18000	35x50	5.30	17	22
50	22000	35x60	5.50	14	18
63	680	22x25	0.70	300	390
63	1000	22x25	1.00	210	270
63	1200	22x25	1.21	170	220
63	1500	22x25	1.36	140	180

WV (Vdc)	Cap (uF)	Size (mm)	Rated Ripple current (Arms/105°C /120Hz)	Typ. ESR 20°C 120Hz (mΩ)	MAX ESR 20°C 120Hz (mΩ)
63	1800	22x30	1.41	120	150
63	1800	25x25	1.46	120	150
63	2200	22x30	1.54	92	120
63	2200	25x25	1.61	92	120
63	2700	22x35	2.02	76	98
63	2700	25x30	2.05	76	98
63	2700	30x25	2.10	76	98
63	3300	22x40	2.12	62	80
63	3300	25x35	2.20	62	80
63	3300	30x25	2.25	62	80
63	3300	35x25	2.32	62	80
63	3900	22x40	2.34	52	68
63	3900	25x35	2.42	52	68
63	3900	30x25	2.43	52	68
63	4700	22x45	2.59	43	56
63	4700	25x40	2.65	43	56
63	4700	30x30	2.71	43	56
63	5600	25x45	2.93	36	47
63	5600	30x35	3.05	36	47
63	5600	35x30	3.09	36	47
63	6800	30x40	3.72	30	39
63	6800	35x35	3.78	30	39
63	8200	30x40	3.82	25	32
63	8200	35x35	3.92	25	32
63	10000	30x45	4.05	20	27
63	10000	35x40	4.10	20	27
63	12000	35x45	4.76	21	28
63	15000	35x50	5.40	17	22
80	680	22x25	0.75	220	290
80	820	22x25	1.11	180	240
80	1000	22x25	1.22	150	200
80	1200	22x30	1.32	130	170
80	1200	25x25	1.39	130	170
80	1500	22x30	1.59	100	130
80	1500	25x25	1.60	100	130
80	1800	22x35	1.71	85	110
80	1800	25x30	1.75	85	110
80	1800	30x25	1.95	85	110
80	2200	22x40	2.12	70	90
80	2200	25x30	2.05	70	90
80	2700	22x45	2.41	57	74
80	2700	25x40	2.45	57	74
80	2700	30x30	2.49	57	74
80	3300	25x45	2.60	46	60
80	3300	30x35	2.64	46	60
80	3300	35x25	2.62	46	60
80	3900	30x35	2.95	39	51
80	3900	35x30	3.05	39	51
80	4700	30x45	3.21	33	42
80	4700	35x30	3.45	33	42
80	4700	35x35	3.51	33	42
80	5600	30x45	3.55	27	36
80	5600	35x35	3.65	27	36
80	6800	30x50	3.72	23	29
80	6800	35x45	3.90	23	29
80	8200	35x50	4.30	19	24
80	10000	35x50	4.40	15	20
100	330	22x25	0.55	460	600
100	470	22x25	0.79	320	420
100	560	22x25	1.06	280	360

WV (Vdc)	Cap (uF)	Size (mm)	Rated Ripple current (Arms/105°C /120Hz)	Typ. ESR 20°C 120Hz (mΩ)	MAX ESR 20°C 120Hz (mΩ)
100	680	22x25	1.16	220	290
100	680	22x30	1.18	220	290
100	680	25x25	1.20	220	290
100	680	30x25	1.25	220	290
100	820	22x25	1.41	180	240
100	820	22x30	1.46	180	240
100	820	25x25	1.51	180	240
100	820	30x25	1.55	180	240
100	1000	22x30	1.71	150	200
100	1000	25x30	1.77	150	200
100	1000	25x35	1.80	150	200
100	1000	30x25	1.81	150	200
100	1200	22x30	1.83	130	170
100	1200	25x25	1.85	130	170
100	1200	25x35	1.94	130	170
100	1200	30x25	1.95	130	170
100	1500	22x35	2.11	100	130
100	1500	25x30	2.15	100	130
100	1500	25x35	2.19	100	130
100	1500	30x25	2.20	100	130
100	1500	35x25	2.26	100	130
100	1800	22x40	2.31	85	110
100	1800	25x35	2.32	85	110
100	1800	25x40	2.38	85	110
100	1800	30x25	2.33	85	110
100	1800	30x30	2.36	85	110
100	1800	35x25	2.40	85	110
100	2200	22x45	2.62	70	90
100	2200	25x40	2.65	70	90
100	2200	30x35	2.75	70	90
100	2200	35x25	2.70	70	90
100	2700	25x45	2.91	57	74
100	2700	30x35	2.93	57	74
100	2700	35x35	3.25	57	74
100	3300	25x50	3.31	46	60
100	3300	30x40	3.37	46	60
100	3300	35x35	3.45	46	60
100	3300	35x40	3.56	46	60
100	3900	30x45	3.68	39	51
100	3900	35x35	3.70	39	51
100	4700	30x50	3.82	33	42
100	4700	35x40	3.84	33	42
100	4700	35x50	3.97	33	42
100	5600	35x45	4.11	27	36
100	6800	35x50	4.51	23	29
100	8200	40x60	4.95	19	24
100	10000	40x60	5.24	15	20
160	220	22x25	0.42	500	900
160	270	22x25	0.95	410	740
160	330	22x25	1.11	330	600
160	330	22x30	1.12	330	600
160	330	25x25	1.13	330	600
160	390	22x25	1.15	280	510
160	390	22x30	1.22	280	510
160	390	25x25	1.25	280	510
160	470	22x25	1.41	230	420
160	470	22x30	1.45	230	420
160	470	25x25	1.50	230	420
160	560	22x25	1.62	200	360
160	560	25x30	1.75	200	360

WV (Vdc)	Cap (uF)	Size (mm)	Rated Ripple current (Arms/105°C /120Hz)	Typ. ESR 20°C 120Hz (mΩ)	MAX ESR 20°C 120Hz (mΩ)
160	680	22x30	1.84	160	290
160	680	25x25	1.86	160	290
160	680	30x25	2.01	160	290
160	820	22x35	2.00	130	240
160	820	25x30	2.01	130	240
160	820	25x45	2.20	130	240
160	820	30x25	2.05	130	240
160	820	30x30	2.10	130	240
160	1000	22x40	2.34	110	200
160	1000	22x50	2.41	110	200
160	1000	25x35	2.36	110	200
160	1000	25x45	2.47	110	200
160	1000	30x25	2.06	110	200
160	1000	30x35	2.47	110	200
160	1200	22x45	2.62	94	170
160	1200	25x35	2.61	94	170
160	1200	30x30	2.66	94	170
160	1200	35x25	2.70	94	170
160	1500	25x40	2.83	72	130
160	1500	30x35	2.89	72	130
160	1500	35x25	2.88	72	130
160	1500	35x30	2.96	72	130
160	1800	25x50	3.25	61	110
160	1800	30x35	3.20	61	110
160	1800	35x30	3.25	61	110
160	2200	30x45	3.26	50	90
160	2200	35x35	3.32	50	90
160	2700	30x50	3.67	41	74
160	2700	35x40	3.68	41	74
160	3300	35x45	3.71	33	60
180	270	22x25	0.98	410	740
180	330	22x25	1.14	330	600
180	390	22x25	1.31	280	510
180	470	22x25	1.46	230	420
180	470	22x30	1.50	230	420
180	560	22x30	1.67	200	360
180	560	25x25	1.69	200	360
180	680	22x35	1.88	160	290
180	680	25x30	1.90	160	290
180	820	22x40	2.12	130	240
180	820	25x30	2.12	130	240
180	820	30x25	2.15	130	240
180	1000	22x45	2.39	110	200
180	1000	25x35	2.39	110	200
180	1000	30x25	2.36	110	200
180	1000	35x25	2.47	110	200
180	1200	22x50	2.70	94	170
180	1200	25x40	2.70	94	170
180	1200	30x35	2.75	94	170
180	1500	25x50	3.00	72	130
180	1500	30x40	3.05	72	130
180	1500	35x30	3.07	72	130
180	1800	30x45	3.20	61	110
180	1800	35x35	3.25	61	110
180	2200	30x50	3.33	50	90
180	2200	35x40	3.35	50	90
180	2700	35x45	3.69	41	74
180	3300	35x50	3.72	33	60
200	100	22x20	0.52	1110	1990
200	120	22x20	0.53	920	1660

WV (Vdc)	Cap (uF)	Size (mm)	Rated Ripple current (Arms/105°C /120Hz)	Typ. ESR 20°C 120Hz (mΩ)	MAX ESR 20°C 120Hz (mΩ)
200	150	22x20	0.70	740	1330
200	150	22x25	0.72	740	1330
200	150	25x20	0.72	740	1330
200	150	25x25	0.73	740	1330
200	180	22x25	0.84	620	1110
200	180	25x20	0.85	620	1110
200	180	30x20	0.87	620	1110
200	220	22x25	0.96	500	900
200	220	25x20	0.96	500	900
200	220	25x25	1.14	500	900
200	220	30x20	1.14	500	900
200	270	22x25	1.10	410	740
200	270	22x30	1.20	410	740
200	270	25x25	1.20	410	740
200	270	30x20	1.20	410	740
200	270	30x25	1.25	410	740
200	330	22x25	1.15	330	600
200	330	22x30	1.22	330	600
200	330	25x25	1.23	330	600
200	330	25x30	1.30	330	600
200	330	30x25	1.30	330	600
200	330	35x20	1.27	330	600
200	390	22x25	1.31	280	510
200	390	22x30	1.37	280	510
200	390	25x25	1.37	280	510
200	390	25x30	1.45	280	510
200	390	30x25	1.45	280	510
200	470	22x30	1.51	230	420
200	470	22x35	1.60	230	420
200	470	25x30	1.60	230	420
200	470	25x35	1.65	230	420
200	470	30x25	1.65	230	420
200	560	22x30	1.67	200	360
200	560	22x35	1.71	200	360
200	560	25x30	1.71	200	360
200	560	25x35	1.80	200	360
200	560	30x25	1.75	200	360
200	560	30x30	1.80	200	360
200	560	35x25	1.76	200	360
200	680	22x35	1.89	160	290
200	680	22x40	2.00	160	290
200	680	25x30	2.00	160	290
200	680	25x35	2.15	160	290
200	680	30x30	2.15	160	290
200	680	35x25	2.15	160	290
200	820	22x40	2.13	130	240
200	820	22x45	2.25	130	240
200	820	25x35	2.25	130	240
200	820	25x40	2.40	130	240
200	820	30x30	2.40	130	240
200	820	35x25	2.40	130	240
200	820	35x30	2.49	130	240
200	1000	22x50	2.45	110	200
200	1000	25x40	2.43	110	200
200	1000	25x45	2.56	110	200
200	1000	30x30	2.45	110	200
200	1000	30x35	2.58	110	200
200	1000	35x25	2.47	110	200
200	1000	35x30	2.58	110	200
200	1200	25x45	2.66	94	170

WV (Vdc)	Cap (uF)	Size (mm)	Rated Ripple current (Arms/105°C /120Hz)	Typ. ESR 20°C 120Hz (mΩ)	MAX ESR 20°C 120Hz (mΩ)
200	1200	25x50	2.78	94	170
200	1200	30x35	2.66	94	170
200	1200	30x40	2.80	94	170
200	1200	35x25	2.70	94	170
200	1200	35x30	2.83	94	170
200	1500	25x50	2.97	72	130
200	1500	30x40	3.06	72	130
200	1500	35x30	3.08	72	130
200	1500	35x45	3.20	72	130
200	1800	30x45	3.26	61	110
200	1800	35x35	3.26	61	110
200	1800	35x40	3.37	61	110
200	2200	30x50	3.51	50	90
200	2200	35x40	3.51	50	90
200	2200	35x45	3.63	50	90
200	2700	35x45	3.70	41	74
200	2700	35x50	3.83	41	74
220	150	22x25	0.73	740	1330
220	180	22x25	0.85	620	1110
220	180	25x25	0.90	620	1110
220	220	22x25	0.97	500	900
220	220	25x25	1.05	500	900
220	220	30x20	1.14	500	900
220	270	22x25	1.11	410	740
220	270	25x25	1.23	410	740
220	330	22x35	1.36	330	600
220	330	25x25	1.36	330	600
220	330	30x25	1.47	330	600
220	390	22x35	1.48	280	510
220	390	25x30	1.48	280	510
220	390	30x25	1.45	280	510
220	470	22x35	1.53	230	420
220	470	25x30	1.54	230	420
220	470	30x25	1.56	230	420
220	560	22x40	1.69	200	360
220	560	25x35	1.73	200	360
220	560	30x30	1.73	200	360
220	560	35x25	1.73	200	360
220	680	22x45	1.91	160	290
220	680	25x40	1.93	160	290
220	680	30x35	2.05	160	290
220	680	35x30	2.06	160	290
220	820	22x50	2.17	130	240
220	820	25x40	2.17	130	240
220	820	30x35	2.18	130	240
220	820	35x30	2.20	130	240
220	1000	25x45	2.46	110	200
220	1000	30x35	2.49	110	200
220	1000	35x30	2.51	110	200
220	1200	25x50	2.79	94	170
220	1200	30x40	2.80	94	170
220	1200	35x35	2.84	94	170
220	1500	30x45	3.07	72	130
220	1500	35x40	3.09	72	130
220	1800	30x50	3.27	61	110
220	1800	35x45	3.27	61	110
220	2200	35x50	3.54	50	90
250	68	22x25	0.38	1630	2930
250	82	22x25	0.48	1350	2430
250	100	22x25	0.53	1110	1990

WV (Vdc)	Cap (uF)	Size (mm)	Rated Ripple current (Arms/105°C /120Hz)	Typ. ESR 20°C 120Hz (mΩ)	MAX ESR 20°C 120Hz (mΩ)
250	100	25x25	0.65	1110	1990
250	120	22x25	0.75	920	1660
250	150	22x25	0.78	740	1330
250	150	25x25	0.85	740	1330
250	150	30x25	0.89	740	1330
250	180	22x25	0.89	620	1110
250	180	30x25	0.95	620	1110
250	220	22x25	1.01	500	900
250	220	22x30	1.07	500	900
250	220	25x25	1.07	500	900
250	220	30x25	1.15	500	900
250	270	22x25	1.15	410	740
250	270	22x30	1.20	410	740
250	270	25x25	1.20	410	740
250	270	25x30	1.25	410	740
250	270	30x25	1.25	410	740
250	270	30x30	1.32	410	740
250	330	22x35	1.26	330	600
250	330	25x25	1.27	330	600
250	330	25x30	1.38	330	600
250	330	30x25	1.38	330	600
250	330	35x25	1.45	330	600
250	390	22x35	1.42	280	510
250	390	25x30	1.45	280	510
250	390	30x25	1.45	280	510
250	390	30x30	1.54	280	510
250	390	35x25	1.56	280	510
250	470	22x35	1.57	230	420
250	470	22x40	1.70	230	420
250	470	25x30	1.67	230	420
250	470	25x35	1.72	230	420
250	470	30x25	1.72	230	420
250	470	30x30	1.79	230	420
250	470	35x25	1.79	230	420
250	560	22x40	1.87	200	360
250	560	22x45	1.97	200	360
250	560	25x35	1.88	200	360
250	560	25x40	1.97	200	360
250	560	30x25	1.88	200	360
250	560	30x30	1.97	200	360
250	560	35x25	1.98	200	360
250	560	35x30	2.10	200	360
250	680	22x45	2.15	160	290
250	680	25x40	2.20	160	290
250	680	30x35	2.24	160	290
250	680	35x30	2.25	160	290
250	820	25x45	2.56	130	240
250	820	30x35	2.56	130	240
250	820	35x30	2.57	130	240
250	1000	25x50	2.85	110	200
250	1000	30x40	2.85	110	200
250	1000	35x30	2.86	110	200
250	1200	30x45	3.20	94	170
250	1200	35x35	2.25	94	170
250	1500	30x50	3.83	72	130
250	1500	35x40	3.91	72	130
250	1800	35x45	4.30	61	110
250	1800	35x50	4.56	61	110
250	1800	35x55	4.88	61	110
250	2200	35x50	5.00	50	90

WV (Vdc)	Cap (uF)	Size (mm)	Rated Ripple current (Arms/105°C /120Hz)	Typ. ESR 20°C 120Hz (mΩ)	MAX ESR 20°C 120Hz (mΩ)
250	2200	35x55	5.19	50	90
315	120	22x25	0.76	920	1660
315	150	22x25	0.83	740	1330
315	180	22x30	0.92	620	1110
315	220	22x30	1.07	500	900
315	270	22x35	1.21	410	740
315	270	25x30	1.25	410	740
315	330	22x45	1.28	330	600
315	330	25x35	1.31	330	600
315	330	30x25	1.28	330	600
315	390	22x45	1.53	280	510
315	390	25x40	1.55	280	510
315	390	30x30	1.56	280	510
315	390	35x25	1.57	280	510
315	470	25x45	1.73	230	420
315	470	30x35	1.80	230	420
315	470	35x25	1.83	230	420
315	560	25x50	1.94	200	360
315	560	30x40	1.95	200	360
315	560	35x30	2.03	200	360
315	680	30x45	2.25	160	290
315	680	35x35	2.26	160	290
315	820	30x50	2.58	130	240
315	820	35x40	2.58	130	240
315	1000	35x45	2.87	110	200
315	1000	35x50	2.88	110	200
315	1200	35x45	2.92	94	170
315	1200	35x50	2.95	94	170
350	82	22x25	0.52	1350	2430
350	100	22x25	0.55	1110	1990
350	120	22x30	0.77	920	1660
350	150	22x30	0.82	740	1330
350	180	22x30	0.90	620	1110
350	180	25x30	0.97	620	1110
350	220	22x35	1.08	500	900
350	220	25x30	1.09	500	900
350	270	22x40	1.22	410	740
350	270	25x35	1.26	410	740
350	270	30x30	1.27	410	740
350	330	22x45	1.29	330	600
350	330	25x40	1.32	330	600
350	330	30x30	1.32	330	600
350	390	25x45	1.56	280	510
350	390	30x35	1.57	280	510
350	390	35x30	1.56	280	510
350	470	25x45	1.74	230	420
350	470	30x40	1.81	230	420
350	470	35x35	1.84	230	420
350	560	30x45	1.96	200	360
350	560	35x40	2.04	200	360
350	680	30x45	2.26	160	290
350	680	35x40	2.27	160	290
350	680	40x35	2.28	160	290
350	820	30x50	2.27	130	240
350	820	35x45	2.59	130	240
350	1000	35x50	2.89	110	200
350	1000	40x45	2.90	110	200
350	1200	35x50	2.87	94	170
350	1200	40x45	2.87	94	170
400	56	22x20	0.46	1970	3550

WV (Vdc)	Cap (uF)	Size (mm)	Rated Ripple current (Arms/105°C /120Hz)	Typ. ESR 20°C 120Hz (mΩ)	MAX ESR 20°C 120Hz (mΩ)
400	68	22x20	0.51	1630	2930
400	82	22x25	0.64	1350	2430
400	82	25x25	0.69	1350	2430
400	100	22x25	0.69	1110	1990
400	100	25x25	0.75	1110	1990
400	120	22x25	0.78	920	1660
400	120	22x30	0.83	920	1660
400	120	25x25	0.83	920	1660
400	150	22x30	0.86	740	1330
400	150	25x25	0.86	740	1330
400	150	25x30	0.90	740	1330
400	150	30x25	0.89	740	1330
400	180	22x35	1.00	620	1110
400	180	25x30	1.05	620	1110
400	180	30x25	1.07	620	1110
400	220	22x40	1.09	500	900
400	220	25x30	1.10	500	900
400	220	30x25	1.10	500	900
400	220	30x30	1.16	500	900
400	270	25x35	1.26	410	740
400	270	30x30	1.28	410	740
400	330	22x45	1.46	330	600
400	330	25x40	1.48	330	600
400	330	30x35	1.52	330	600
400	330	35x30	1.52	330	600
400	390	25x45	1.69	280	510
400	390	30x40	1.72	280	510
400	390	35x35	1.74	280	510
400	470	25x50	1.84	230	420
400	470	30x40	1.92	230	420
400	470	35x35	1.95	230	420
400	560	30x45	2.32	200	360
400	560	35x40	2.33	200	360
400	680	30x50	2.68	160	290
400	680	35x45	2.75	160	290
400	820	35x45	2.92	130	240
400	820	35x50	2.97	130	240
400	1000	35x50	3.15	110	200
400	1200	35x60	3.29	94	170
400	1200	40x50	3.29	94	170
420	68	22x25	0.53	2170	3900
420	82	22x25	0.65	1790	3230
420	82	25x25	0.70	1790	3230
420	100	22x25	0.71	1470	2650
420	100	22x30	0.75	1470	2650
420	100	25x25	0.75	1470	2650
420	100	25x30	0.82	1470	2650
420	100	30x25	0.83	1470	2650
420	120	22x30	0.82	1230	2210
420	120	22x35	0.86	1230	2210
420	120	25x25	0.82	1230	2210
420	120	25x30	0.86	1230	2210
420	120	30x25	0.86	1230	2210
420	120	35x25	0.95	1230	2210
420	150	22x30	0.91	980	1770
420	150	22x35	0.93	980	1770
420	150	22x40	0.95	980	1770
420	150	25x30	0.94	980	1770
420	150	25x35	0.97	980	1770
420	150	30x25	0.98	980	1770
420	150	30x30	1.06	980	1770
420	150	35x25	1.08	980	1770
420	180	22x35	1.02	820	1470
420	180	22x40	1.05	820	1470
420	180	25x30	1.05	820	1470
420	180	25x35	1.10	820	1470
420	180	30x25	1.10	820	1470
420	180	30x30	1.19	820	1470
420	220	22x40	1.13	670	1210
420	220	22x45	1.19	670	1210

WV (Vdc)	Cap (uF)	Size (mm)	Rated Ripple current (Arms/105°C /120Hz)	Typ. ESR 20°C 120Hz (mΩ)	MAX ESR 20°C 120Hz (mΩ)
420	220	25x35	1.15	670	1210
420	220	30x25	1.16	670	1210
420	220	30x30	1.21	670	1210
420	220	35x25	1.23	670	1210
420	270	22x50	1.27	540	980
420	270	25x40	1.26	540	980
420	270	30x30	1.28	540	980
420	270	35x25	1.30	540	980
420	330	22x50	1.41	440	800
420	330	25x45	1.49	440	800
420	330	30x35	1.49	440	800
420	330	30x40	1.54	440	800
420	330	35x30	1.54	440	800
420	330	35x35	1.67	440	800
420	390	22x55	1.62	380	680
420	390	25x50	1.70	380	680
420	390	30x40	1.72	380	680
420	390	35x35	1.75	380	680
420	470	25x50	1.85	310	560
420	470	30x45	1.90	310	560
420	470	35x35	1.90	310	560
420	470	35x40	1.97	310	560
420	560	30x50	2.23	260	470
420	560	35x40	2.24	260	470
420	560	35x45	2.32	260	470
420	680	35x45	2.76	220	390
420	680	35x50	2.77	220	390
420	820	35x55	2.98	180	320
420	1000	35x60	3.15	150	270
420	1000	40x50	3.25	150	270
450	68	22x25	0.53	2170	3900
450	82	22x25	0.66	1790	3230
450	82	22x30	0.71	1790	3230
450	82	25x25	0.71	1790	3230
450	100	22x25	0.72	1470	2650
450	100	22x30	0.75	1470	2650
450	100	25x25	0.75	1470	2650
450	100	25x30	0.82	1470	2650
450	100	30x25	0.83	1470	2650
450	120	22x30	0.82	1230	2210
450	120	22x35	0.86	1230	2210
450	120	25x25	0.82	1230	2210
450	120	25x30	0.86	1230	2210
450	120	30x25	0.86	1230	2210
450	120	35x25	0.95	1230	2210
450	150	22x30	0.91	980	1770
450	150	22x35	0.93	980	1770
450	150	22x40	0.95	980	1770
450	150	25x30	0.94	980	1770
450	150	25x35	0.97	980	1770
450	150	30x25	0.98	980	1770
450	150	30x30	1.06	980	1770
450	150	35x25	1.08	980	1770
450	180	22x35	1.02	820	1470
450	180	22x40	1.05	820	1470
450	180	25x30	1.05	820	1470
450	180	25x35	1.10	820	1470
450	180	30x25	1.10	820	1470
450	180	30x30	1.19	820	1470
450	180	35x25	1.20	820	1470

WV (Vdc)	Cap (uF)	Size (mm)	Rated Ripple current (Arms/105°C /120Hz)	Typ. ESR 20°C 120Hz (mΩ)	MAX ESR 20°C 120Hz (mΩ)
450	180	35x30	1.28	820	1470
450	220	22x40	1.12	670	1210
450	220	22x45	1.20	670	1210
450	220	25x35	1.20	670	1210
450	220	25x40	1.25	670	1210
450	220	30x25	1.17	670	1210
450	220	30x30	1.25	670	1210
450	220	35x25	1.24	670	1210
450	220	35x30	1.33	670	1210
450	270	22x50	1.30	540	980
450	270	25x40	1.30	540	980
450	270	30x30	1.29	540	980
450	270	30x35	1.42	540	980
450	270	35x25	1.35	540	980
450	270	35x30	1.42	540	980
450	330	25x50	1.68	440	800
450	330	30x35	1.54	440	800
450	330	30x40	1.69	440	800
450	330	35x30	1.70	440	800
450	330	35x35	1.87	440	800
450	390	25x50	1.71	380	680
450	390	30x40	1.69	380	680
450	390	30x45	1.90	380	680
450	390	35x35	1.91	380	680
450	390	35x40	2.07	380	680
450	470	30x45	1.94	310	560
450	470	30x50	2.23	310	560
450	470	35x35	1.97	310	560
450	470	35x40	2.10	310	560
450	470	35x45	2.50	310	560
450	560	30x50	2.44	260	470
450	560	35x40	2.40	260	470
450	560	35x45	2.50	260	470
450	560	35x50	2.79	260	470
450	680	35x45	2.77	220	390
450	680	35x50	2.90	220	390
450	820	35x55	3.08	180	320
450	820	35x60	3.22	180	320
450	1000	35x65	3.31	150	270
450	1000	40x60	3.40	150	270
450	1200	35x80	3.62	120	220
450	1200	40x70	3.67	120	220
500	47	22x25	0.42	3130	5640
500	56	22x30	0.50	2630	4740
500	56	25x25	0.51	2630	4740
500	68	22x30	0.55	2170	3900
500	68	25x25	0.55	2170	3900
500	82	22x35	0.73	1790	3230
500	82	25x30	0.75	1790	3230
500	82	30x25	0.76	1790	3230
500	100	22x40	0.90	1470	2650
500	100	22x45	0.94	1470	2650

WV (Vdc)	Cap (uF)	Size (mm)	Rated Ripple current (Arms/105°C /120Hz)	Typ. ESR 20°C 120Hz (mΩ)	MAX ESR 20°C 120Hz (mΩ)
500	100	25x35	0.92	1470	2650
500	100	30x25	0.93	1470	2650
500	100	30x30	0.96	1470	2650
500	120	22x50	0.94	1230	2210
500	120	25x35	0.93	1230	2210
500	120	25x40	0.94	1230	2210
500	120	30x30	0.94	1230	2210
500	120	35x25	0.94	1230	2210
500	150	22x50	1.10	980	1770
500	150	25x40	1.10	980	1770
500	150	30x35	1.13	980	1770
500	150	35x25	1.00	980	1770
500	150	35x30	1.14	980	1770
500	180	25x50	1.39	820	1470
500	180	30x35	1.31	820	1470
500	180	30x40	1.40	820	1470
500	180	35x30	1.41	820	1470
500	220	25x55	1.62	670	1210
500	220	30x40	1.59	670	1210
500	220	30x45	1.63	670	1210
500	220	35x35	1.65	670	1210
500	270	30x50	1.75	540	980
500	270	35x40	1.76	540	980
500	330	30x55	2.03	440	800
500	330	35x45	2.05	440	800
500	390	35x50	2.47	380	680
500	470	35x55	2.63	310	560
500	680	35x65	3.19	220	390
500	820	35x75	3.85	180	320
500	820	40x65	3.85	180	320
500	1000	40x80	4.70	150	270
550	47	25x25	0.48	3130	5640
550	56	25x30	0.55	2630	4740
550	68	25x35	0.63	2170	3900
550	68	30x25	0.65	2170	3900
550	82	25x35	0.76	1790	3230
550	82	30x30	0.77	1790	3230
550	100	25x40	0.93	1470	2650
550	100	30x35	0.94	1470	2650
550	100	35x25	0.93	1470	2650
550	120	25x50	0.96	1230	2210
550	120	30x35	0.98	1230	2210
550	120	35x30	1.06	1230	2210
550	150	25x55	1.13	980	1770
550	150	30x45	1.18	980	1770
550	150	35x35	1.22	980	1770
550	180	30x50	1.35	820	1470
550	180	35x40	1.38	820	1470
550	220	30x55	1.56	670	1210
550	220	35x45	1.58	670	1210
550	270	35x50	1.80	540	980

Useful life

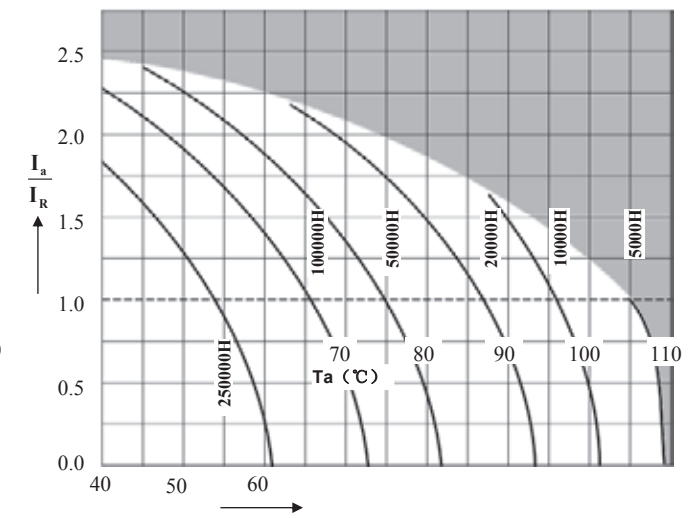
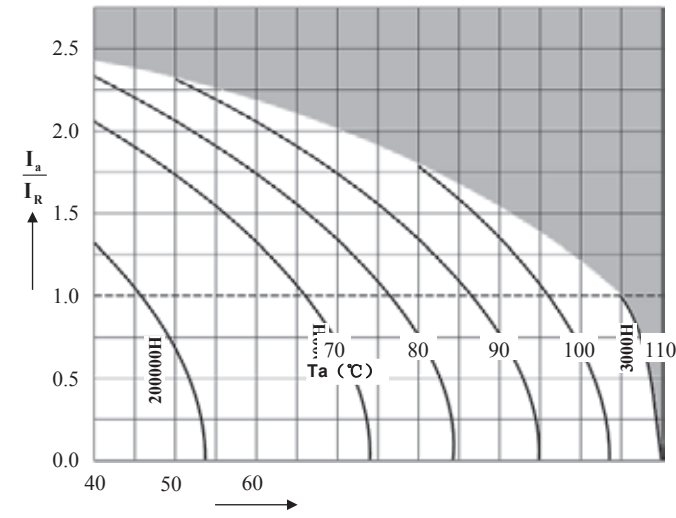

depending on ambient temperature T_a versus under ripple current operating conditions $V_R \leq 100V$

depending on ambient temperature T_a versus under ripple current operating conditions $V_R \geq 160V$

HW Series Snap-in Type 105°C 15mm Height



Features

- ◆ Endurance 2000 hours 105°C with height 15mm
- ◆ ROHS compliant

Specifications

Item	Performance Characteristics		
Operating Temperature Range	-40 to +85°C		-25 to +85°C
Rated voltage V_R	6.3 to 450 V DC		500 to 600 V DC
Surge voltage V_S	$V_R \leq 315V$ 1.15 V_R $V_R > 315V$ 1.10 V_R		
Rated capacitance C_R	22 to 100000 μF		
Capacitance tolerance	$\pm 20\%$ (120Hz, +20°C)		
Leakage Current I_{leak} (+20°C, max.)	$I \leq 3 \sqrt{CV}$ (μA) After 5 minutes with rated working voltage applied		
Dissipation Factor ($\tan \delta$, at 20°C, 120Hz)	Less than the value under table(%)		
	V_R (dc)	160-250	315-450
	D.F.	20%	20%
Self-inductance ESL	approx. 20 nH		
Useful life 105°C; $V_R, I_{AC,R}$	$V_R \leq 100V$: >5000 h	Requirements:	
		$\Delta C/C$	$\leq \pm 30\%$ of initial value
		$\tan \delta$	≤ 3 times initial specified limit
		I_{leak}	\leq initial specified limit
Voltage Endurance test 105°C; V_R	2000 h	Post test requirements:	
		$\Delta C/C$	$\leq \pm 20\%$ of initial value
		$\tan \delta$	≤ 2 times initial specified limit
		I_{leak}	\leq initial specified limit
Shelf Life 105°C	1000 h	Post test requirements:	
		$\Delta C/C$	$\leq \pm 20\%$ of initial value
		$\tan \delta$	≤ 2 times initial specified limit
		I_{leak}	\leq initial specified limit
Vibration Resistance test	To IEC 60068-2-6, test Fc:		
	Displacement amplitude 0.75 mm, frequency range 10 ... 55 Hz, acceleration max. 10 g, duration 3x2 h. Capacitor mounted by its body which is rigidly clamped to the work surface.		
Characteristics at low temperature	Max. impedance ratio at 120 Hz		
	V_R (V)	160-250	315-450
	$Z_{-25^\circ C} / Z_{20^\circ C}$	4	8
	$Z_{-40^\circ C} / Z_{20^\circ C}$	10	14
Sectional specification	IEC 60384-4 and JIS-C-5101		

Multiplier for Ripple Current vs. Frequency

V_R (V)/Frequency(Hz)	50(60)	120	300	1K	10K	50K-100K
$160 \leq V_R \leq 250$	0.81	1	1.17	1.32	1.45	1.5
$315 \leq V_R \leq 450$	0.77	1	1.16	1.30	1.41	1.43

Dimensional drawings

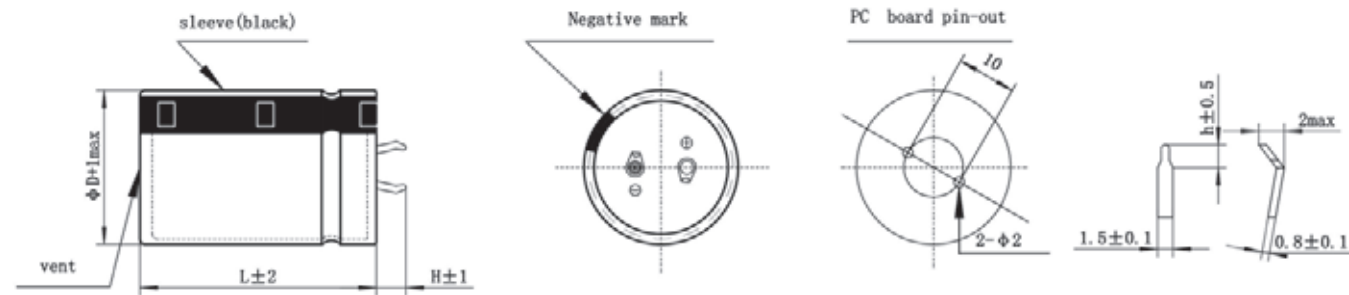

Standard snap-in terminals: length (6.0 ± 1) mm
 Also available with length of (4.0 ± 1) mm

H	h
6	2.5
4	1.5

Packing

Capacitor diameter D(mm)	Length L(mm)	Terminal length H(mm)	Each carton packing Qty units(pcs.)	Box/carton units(pcs.)	Each box packing Qty units(pcs.)
20	all	/	720	6	120
22	< 55	/	600	6	100
22	≥ 55	/	400	4	100
25	< 65	/	500	5	100
25	≥ 65	/	400	4	100
30	≤ 36	< 6(L=35、36)	400	8	50
30	35 ≤ L ≤ 65	≥ 6(L=35、36)	300	6	50
30	> 65	/	200	4	50
35	≤ 25	/	400	8	50
35	25 < L < 45	/	300	6	50
35	45 ≤ L ≤ 85	/	200	4	50
35	> 85	/	100	2	50
40	35	< 6	200	5	40
40	35	≥ 6	160	4	40
40	40 ≤ L ≤ 45	/	160	4	40
40	45 < L ≤ 75	/	120	3	40
40	> 75	/	80	2	40
45	40 ≤ L ≤ 65	/	140	4	35
45	65 < L ≤ 100	/	70	2	35

Packing of snap-in



Case Size

WV (Vdc)	Cap (uF)	Size (mm)	Rated Ripple current (Arms/105°C /120Hz)	Typ. ESR 20°C 120Hz (mΩ)	MAX ESR 20°C 120Hz (mΩ)
160	150	20x15	0.55	980	1770
160	180	22x15	0.65	820	1470
160	220	25x15	0.80	670	1210
160	270	30x15	0.95	540	980
160	330	30x15	1.00	440	800
160	390	35x15	1.20	380	680
180	120	20x15	0.50	1230	2210
180	150	22x15	0.60	980	1770
180	180	25x15	0.75	820	1470
180	220	30x15	0.85	670	1210
180	270	30x15	1.00	540	980
180	330	35x15	1.10	440	800
180	390	35x15	1.20	380	680
200	100	20x15	0.45	1470	2650
200	120	22x15	0.55	1230	2210
200	150	25x15	0.65	980	1770
200	180	25x15	0.75	820	1470
200	180	30x15	0.80	820	1470
200	220	30x15	0.90	670	1210
200	270	30x15	1.00	540	980

WV (Vdc)	Cap (uF)	Size (mm)	Rated Ripple current (Arms/105°C /120Hz)	Typ. ESR 20°C 120Hz (mΩ)	MAX ESR 20°C 120Hz (mΩ)
200	330	35x15	1.10	440	800
250	100	22x15	0.50	1470	2650
250	120	25x15	0.60	1230	2210
250	150	30x15	0.70	980	1770
250	180	30x15	0.75	820	1470
250	220	35x15	0.90	670	1210
250	270	35x15	1.00	540	980
315	56	22x15	0.35	2630	4740
315	68	25x15	0.40	2170	3900
315	82	30x15	0.45	1790	3230
315	100	30x15	0.50	1470	2650
315	120	35x15	0.55	1230	2210
315	150	35x15	0.60	980	1770
400	39	22x15	0.30	3780	6800
400	47	25x15	0.35	3130	5640
400	56	30x15	0.40	2630	4740
400	68	30x15	0.45	2170	3900
400	82	35x15	0.50	1790	3230
400	100	35x15	0.55	1470	2650

Useful life

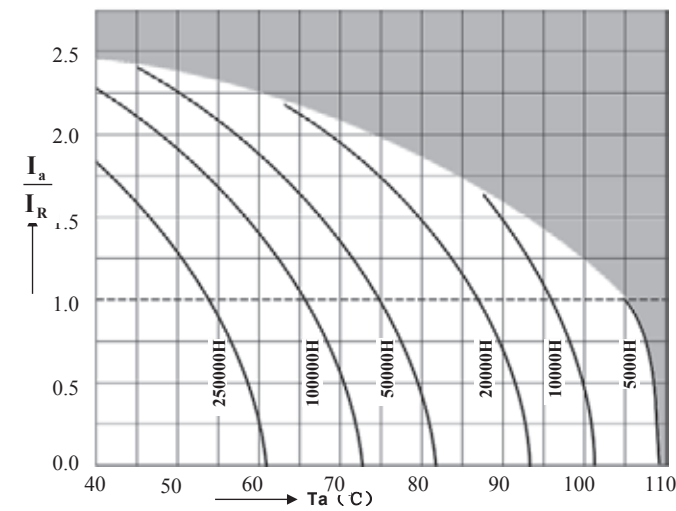

depending on ambient temperature T_a versus under ripple current operating conditions

HU Series 105°C 3000H



Features

Standard capacitors

Applications

- ◆ Switch-mode power supplies in industrial and entertainment electronics
- ◆ Uninterruptible power supplies

Features

- ◆ High reliability
- ◆ Long useful life
- ◆ High ripple current capability
- ◆ Aluminum case designed explosion-proof vent
- ◆ RoHS-compatible

Construction

- ◆ Charge-discharge proof, polar
- ◆ Aluminum case with insulating sleeve
- ◆ Aluminum case designed explosion-proof vent
- ◆ Snap-in solder pins to hold component in place on PC-board

Specifications

Item	Performance Characteristics											
Operating Temperature Range	-40 to +105°C	-25 to +105°C										
Rated voltage V_R	10 to 450 V DC	500 V DC										
Surge voltage V_S	$V_R \leq 315V$ 1.15 V_R $V_R > 315V$ 1.10 V_R											
Rated capacitance C_R	33 to 82000 μF	39 to 470 μF										
Capacitance tolerance	$\pm 20\%$ (120Hz,+20°C)											
Leakage Current I_{leak} (+20°C.max.)	$I \leq 3 \sqrt{CV}$ (μA)After 5minutes with rated working voltage applied											
Dissipation Factor ($\tan \delta$, at 20°C, 120Hz)	Less than the value under table(%)											
	$\mu F/Vdc$	6.3	10	16	25	35	50	63	80	100	160~420	450~500
	≤ 8200	-	35	35	30	25	20	20	15	15	15	20
	10000 to 22000	55	40	40	35	30	30	25	15	-	-	-
≥ 27000	60	50	40	35	35	30	25	-	-	-	-	
Self-inductance ESL	approx. 20 nH											
Useful life 105°C; $V_R, I_{AC,R}$ 105°C; $V_R, I_{AC,R}$	$V_R \leq 100V$:	Requirements:										
	>5000 h	$V_R \leq 100V$ DC/C $\leq \pm 30\%$ of initial value ESR ≤ 3 times initial specified limit $I_{leak} \leq$ initial specified limit					$V_R > 100V$ DC/C $\leq \pm 20\%$ of initial value ESR ≤ 2 times initial specified limit $I_{leak} \leq$ initial specified limit					
Voltage Endurance test 105°C; V_R	3000 h	Post test requirements:										
		$V_R \leq 100V$ DC/C $\leq \pm 15\%$ of initial value ESR ≤ 1.3 times initial specified limit $I_{leak} \leq$ initial specified limit					$V_R > 100V$ DC/C $\leq \pm 10\%$ of initial value ESR ≤ 1.3 times initial specified limit $I_{leak} \leq$ initial specified limit					
Shelf Life 105°C	1000 h	Post test requirements:										
		$V_R \leq 100V$ DC/C $\leq \pm 15\%$ of initial value ESR ≤ 1.3 times initial specified limit $I_{leak} \leq$ initial specified limit					$V_R > 100V$ DC/C $\leq \pm 10\%$ of initial value ESR ≤ 1.3 times initial specified limit $I_{leak} \leq$ initial specified limit					
Vibration Resistance test	To IEC 60068-2-6, test Fc: Displacement amplitude 0.75 mm, frequency range 10 ... 55 Hz, acceleration max. 10 g, duration 3x2 h. Capacitor mounted by its body which is rigidly clamped to the work surface.											
Characteristics at low temperature	Max. impedance ratio at 120 Hz											
	$V_R(V)$	6.3~16	25	35	50~100	160~250	315~450	500				
	$Z_{-25^\circ C} / Z_{20^\circ C}$	4	3	3	3	3	8	8				
$Z_{-40^\circ C} / Z_{20^\circ C}$	15	10	8	6	7	10	-					
Sectional specification	IEC 60384-4 and JIS-C-5101											

Snap-in

Multiplier for Ripple Current vs. Frequency

$V_R(V)/$ Frequency(Hz)	50(60)	120	300	1K	10K	50K-100K
$10 \leq V_R \leq 100$	0.88	1	1.07	1.15	1.15	1.15
$160 \leq V_R \leq 250$	0.81	1	1.17	1.32	1.45	1.5
$315 \leq V_R \leq 600$	0.77	1	1.16	1.30	1.41	1.43

Dimensional drawings

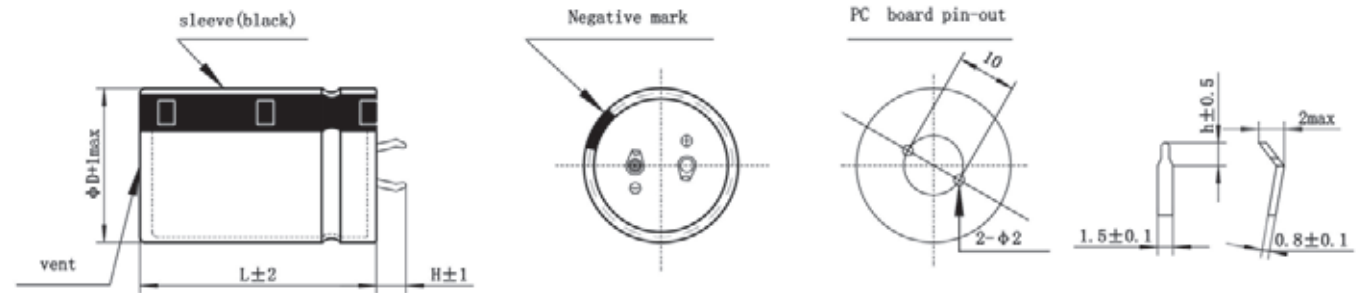

Standard snap-in terminals: length (6.0 ± 1) mm
 Also available with length of (4.0 ± 1) mm

H	h
6	2.5
4	1.5

Packing

Capacitor diameter D(mm)	Length L(mm)	Terminal length H(mm)	Each carton packing Qty units(pcs.)	Box/carton units(pcs.)	Each box packing Qty units(pcs.)
20	all	/	720	6	120
22	< 55	/	600	6	100
22	≥ 55	/	400	4	100
25	< 65	/	500	5	100
25	≥ 65	/	400	4	100
30	≤ 36	< $6(L=35, 36)$	400	8	50
30	$35 \leq L \leq 65$	$\geq 6(L=35, 36)$	300	6	50
30	> 65	/	200	4	50
35	≤ 25	/	400	8	50
35	$25 < L < 45$	/	300	6	50
35	$45 \leq L \leq 85$	/	200	4	50
35	> 85	/	100	2	50
40	35	< 6	200	5	40
40	35	≥ 6	160	4	40
40	$40 \leq L \leq 45$	/	160	4	40
40	$45 < L \leq 75$	/	120	3	40
40	> 75	/	80	2	40
45	$40 \leq L \leq 65$	/	140	4	35
45	$65 < L \leq 100$	/	70	2	35

Packing of snap-in



Case Size

WV (Vdc)	Cap (uF)	Size (mm)	Rated Ripple current (Arms/105°C /120Hz)	Typ. ESR 20°C 120Hz (mΩ)	MAX ESR 20°C 120Hz (mΩ)
10	4700	22x25	0.86	76	99
10	6800	22x25	1.31	53	68
10	8200	25x20	1.60	44	57
10	10000	25x20	1.81	36	46
10	12000	22x30	2.11	34	44
10	15000	22x35	2.31	27	35
10	18000	22x40	2.40	23	29
10	22000	25x35	2.60	19	24
10	27000	35x25	3.11	19	25
10	33000	35x30	3.42	15	20
10	39000	35x30	3.70	13	17
10	47000	35x35	4.21	11	14
10	56000	35x40	5.10	9	12
10	68000	35x50	5.51	8	10
16	3300	22x25	1.30	110	140
16	4700	22x25	1.52	76	99
16	6800	22x25	1.81	53	68
16	8200	22x30	2.05	44	57
16	10000	22x30	2.15	36	46
16	10000	25x25	2.20	36	46
16	12000	22x35	2.31	34	44
16	12000	25x30	2.32	34	44
16	12000	30x25	2.40	34	44
16	15000	22x40	2.70	27	35
16	15000	25x35	2.71	27	35
16	15000	30x30	2.73	27	35
16	18000	22x45	2.98	23	29
16	18000	25x40	3.17	23	29
16	18000	30x30	3.20	23	29
16	22000	25x45	3.41	19	24
16	22000	30x35	3.42	19	24
16	22000	35x30	3.43	19	24
16	27000	25x50	3.85	15	20
16	27000	30x40	3.86	15	20
16	27000	35x30	3.87	15	20
16	33000	30x45	4.40	12	16
16	33000	35x35	4.42	12	16
16	39000	30x50	4.82	10	14
16	39000	35x40	4.83	10	14
16	47000	35x45	5.54	9	11
16	56000	35x50	5.90	7	10
16	68000	35x60	6.60	6	8
16	82000	40x60	7.66	5	7
25	2200	22x25	1.30	140	180
25	3300	22x25	1.31	92	120
25	4700	22x25	1.62	65	85
25	5600	22x30	1.80	55	71
25	6800	25x25	1.92	45	59
25	8200	22x35	2.15	37	49
25	8200	30x25	2.30	37	49
25	10000	22x40	2.50	31	40
25	10000	25x30	2.50	31	40
25	10000	30x30	2.68	31	40
25	12000	22x45	2.76	30	39
25	12000	25x40	2.81	30	39
25	12000	30x30	2.82	30	39
25	15000	25x45	3.28	24	31
25	15000	30x35	3.29	24	31

WV (Vdc)	Cap (uF)	Size (mm)	Rated Ripple current (Arms/105°C /120Hz)	Typ. ESR 20°C 120Hz (mΩ)	MAX ESR 20°C 120Hz (mΩ)
25	15000	35x30	3.30	24	31
25	18000	25x50	3.55	20	26
25	18000	30x40	3.56	20	26
25	22000	30x45	4.25	16	21
25	22000	35x35	4.26	16	21
25	27000	35x45	4.76	13	17
25	33000	35x50	5.50	11	14
35	2200	25x25	1.52	120	150
35	3300	22x25	1.53	77	100
35	3900	22x30	1.70	65	85
35	4700	22x35	2.03	54	71
35	4700	25x25	2.04	54	71
35	5600	22x35	2.13	46	59
35	5600	25x30	2.14	46	59
35	5600	30x25	2.15	46	59
35	6800	22x40	2.60	38	49
35	6800	25x35	2.60	38	49
35	6800	30x25	2.55	38	49
35	8200	22x50	2.85	31	40
35	8200	25x40	2.86	31	40
35	8200	30x30	2.87	31	40
35	10000	25x45	3.07	26	33
35	10000	30x35	3.08	26	33
35	12000	25x50	3.37	26	33
35	12000	30x40	3.38	26	33
35	12000	35x30	3.40	26	33
35	15000	30x45	3.75	20	27
35	15000	35x35	3.76	20	27
35	18000	35x40	4.37	17	22
35	22000	35x50	4.95	14	18
50	1500	25x20	1.15	140	180
50	1800	22x25	1.35	120	150
50	2200	22x25	1.55	92	120
50	2700	22x30	1.75	76	98
50	2700	25x25	1.76	76	98
50	3300	22x35	1.99	62	80
50	3300	25x30	2.00	62	80
50	3900	22x40	2.25	52	68
50	3900	30x25	2.26	52	68
50	4700	22x45	2.56	43	56
50	4700	25x35	2.62	43	56
50	4700	30x30	2.63	43	56
50	5600	22x50	2.89	36	47
50	5600	25x40	2.90	36	47
50	5600	30x30	2.95	36	47
50	6800	25x45	3.37	30	39
50	6800	30x35	3.39	30	39
50	6800	35x30	3.40	30	39
50	8200	30x40	3.71	25	32
50	8200	35x35	3.72	25	32
50	10000	30x50	4.09	20	27
50	10000	35x40	4.10	20	27
50	12000	35x45	4.56	26	33
50	15000	35x50	4.77	20	27
63	1000	22x25	1.17	210	270
63	1200	22x25	1.25	170	220
63	1500	22x30	1.48	140	180
63	1500	25x25	1.50	140	180

WV (Vdc)	Cap (uF)	Size (mm)	Rated Ripple current (Arms/105°C /120Hz)	Typ. ESR 20°C 120Hz (mΩ)	MAX ESR 20°C 120Hz (mΩ)
63	1800	22x30	1.59	120	150
63	1800	25x25	1.60	120	150
63	2200	22x35	1.83	92	120
63	2200	25x30	1.84	92	120
63	2700	22x40	2.05	76	98
63	2700	25x35	2.05	76	98
63	2700	30x25	2.03	76	98
63	3300	22x45	2.33	62	80
63	3300	30x30	2.40	62	80
63	3900	25x40	2.54	52	68
63	3900	30x35	2.57	52	68
63	4700	25x50	2.98	43	56
63	4700	30x40	3.02	43	56
63	4700	35x30	3.05	43	56
63	5600	30x40	3.28	36	47
63	5600	35x35	3.31	36	47
63	6800	30x50	3.73	30	39
63	6800	35x40	3.75	30	39
63	8200	35x45	4.20	25	32
63	10000	35x50	4.70	20	27
80	680	22x25	1.00	220	290
80	820	22x25	1.15	180	240
80	1000	22x25	1.29	150	200
80	1200	22x30	1.63	130	170
80	1200	25x25	1.65	130	170
80	1500	22x30	1.75	100	130
80	1500	25x25	1.76	100	130
80	1800	22x35	1.83	85	110
80	1800	25x30	1.86	85	110
80	1800	30x25	1.87	85	110
80	2200	22x40	2.09	70	90
80	2200	25x35	2.10	70	90
80	2200	30x25	2.11	70	90
80	2700	25x40	2.43	57	74
80	2700	30x30	2.44	57	74
80	3300	25x45	2.76	46	60
80	3300	30x35	2.79	46	60
80	3300	35x30	2.80	46	60
80	3900	25x50	3.09	39	51
80	3900	30x40	3.12	39	51
80	3900	35x30	3.13	39	51
80	4700	30x45	3.52	33	42
80	4700	35x35	3.53	33	42
80	5600	30x50	3.80	27	36
80	5600	35x40	3.87	27	36
80	6800	35x45	4.19	23	29
100	330	22x20	0.80	460	600
100	470	22x25	0.92	320	420
100	470	25x20	1.00	320	420
100	560	22x25	1.10	280	360
100	680	22x30	1.22	220	290
100	680	25x25	1.24	220	290
100	820	22x30	1.88	180	240
100	820	25x25	1.96	180	240
100	1000	22x30	1.93	150	200
100	1000	25x25	1.92	150	200
100	1200	22x40	2.08	130	170
100	1200	25x30	2.08	130	170
100	1200	30x25	2.08	130	170
100	1500	22x45	2.15	100	130

WV (Vdc)	Cap (uF)	Size (mm)	Rated Ripple current (Arms/105°C /120Hz)	Typ. ESR 20°C 120Hz (mΩ)	MAX ESR 20°C 120Hz (mΩ)
100	1500	25x35	2.15	100	130
100	1500	30x30	2.15	100	130
100	1500	35x25	2.15	100	130
100	1800	25x40	2.37	85	110
100	1800	30x35	2.37	85	110
100	2200	25x50	2.65	70	90
100	2200	30x35	2.61	70	90
100	2200	35x30	2.75	70	90
100	2700	25x50	2.76	57	74
100	2700	30x45	2.96	57	74
100	2700	35x35	2.96	57	74
100	3300	30x50	3.34	46	60
100	3300	35x40	3.34	46	60
100	3900	35x45	3.69	39	51
100	4700	35x50	4.15	33	42
160	220	20x25	0.81	470	900
160	220	22x20	0.78	470	900
160	270	22x25	1.01	390	740
160	270	25x20	1.01	390	740
160	330	22x25	1.17	320	600
160	330	25x20	1.17	320	600
160	390	22x30	1.43	270	510
160	390	25x25	1.43	270	510
160	470	22x30	1.52	220	420
160	470	25x25	1.52	220	420
160	470	30x20	1.53	220	420
160	680	22x40	1.53	150	290
160	680	25x30	1.53	150	290
160	680	30x25	1.53	150	290
160	680	35x20	1.56	150	290
160	820	22x45	1.96	130	240
160	820	25x35	1.96	130	240
160	820	30x30	1.96	130	240
160	820	35x25	1.96	130	240
160	1000	25x40	2.23	110	200
160	1200	25x45	2.40	89	170
160	1200	30x35	2.40	89	170
160	1200	35x30	2.40	89	170
160	1500	25x50	2.60	68	130
160	1500	30x40	2.60	68	130
160	1500	35x30	2.60	68	130
160	1800	30x45	2.82	58	110
160	1800	35x35	2.82	58	110
160	2200	30x50	3.32	48	90
160	2200	35x45	3.50	48	90
160	2700	35x50	3.78	39	74
160	3300	35x55	3.86	32	60
180	180	22x20	0.76	580	1110
180	220	25x20	0.90	470	900
180	270	22x25	1.02	390	740
180	270	25x20	1.03	390	740
180	330	20x30	1.20	320	600
180	330	22x25	1.20	320	600
180	330	25x20	1.22	320	600
180	390	22x30	1.32	270	510
180	390	25x25	1.35	270	510
180	390	30x20	1.35	270	510
180	470	22x35	1.53	220	420
180	470	25x30	1.54	220	420
180	470	30x25	1.55	220	420

WV (Vdc)	Cap (uF)	Size (mm)	Rated Ripple current (Arms/105°C /120Hz)	Typ. ESR 20°C 120Hz (mΩ)	MAX ESR 20°C 120Hz (mΩ)
180	560	22x40	1.67	190	360
180	560	25x30	1.67	190	360
180	560	30x25	1.67	190	360
180	560	35x20	1.67	190	360
180	680	22x45	1.78	150	290
180	680	25x35	1.78	150	290
180	680	30x30	1.78	150	290
180	680	35x25	1.78	150	290
180	820	22x50	2.09	130	240
180	820	25x40	2.09	130	240
180	820	30x30	2.09	130	240
180	820	35x25	2.09	130	240
180	1000	22x50	2.15	110	200
180	1000	25x45	2.15	110	200
180	1000	30x35	2.15	110	200
180	1000	35x30	2.15	110	200
180	1200	22x60	2.22	89	170
180	1200	25x50	2.22	89	170
180	1200	30x40	2.22	89	170
180	1200	35x30	2.22	89	170
180	1500	25x50	2.24	68	130
180	1500	30x45	2.24	68	130
180	1500	35x35	2.24	68	130
180	1800	30x50	2.88	58	110
180	1800	35x35	2.88	58	110
180	1800	35x40	2.94	58	110
180	2200	30x55	3.12	48	90
180	2200	35x45	3.12	48	90
180	2200	35x50	3.23	48	90
180	2200	35x55	3.32	48	90
180	2700	35x50	3.81	39	74
200	150	20x20	0.74	700	1330
200	180	22x20	0.76	580	1110
200	220	20x25	1.01	470	900
200	220	22x25	1.05	470	900
200	220	25x20	1.06	470	900
200	270	20x25	1.07	390	740
200	270	22x25	1.11	390	740
200	330	20x30	1.21	320	600
200	330	22x30	1.26	320	600
200	330	25x25	1.27	320	600
200	390	20x35	1.35	270	510
200	390	22x25	1.35	270	510
200	390	22x30	1.36	270	510
200	390	25x25	1.37	270	510
200	470	20x40	1.55	220	420
200	470	22x30	1.56	220	420
200	470	22x35	1.57	220	420
200	470	25x30	1.58	220	420
200	470	30x25	1.59	220	420
200	560	20x45	1.73	190	360
200	560	22x35	1.73	190	360
200	560	22x40	1.77	190	360
200	560	25x30	1.77	190	360
200	560	30x25	1.77	190	360
200	680	22x40	2.12	150	290
200	680	22x45	2.15	150	290
200	680	25x35	2.15	150	290
200	680	30x30	2.15	150	290
200	680	35x25	2.15	150	290

WV (Vdc)	Cap (uF)	Size (mm)	Rated Ripple current (Arms/105°C /120Hz)	Typ. ESR 20°C 120Hz (mΩ)	MAX ESR 20°C 120Hz (mΩ)
200	820	22x50	2.19	130	240
200	820	25x45	2.19	130	240
200	820	30x25	2.20	130	240
200	820	30x30	2.24	130	240
200	820	35x25	2.24	130	240
200	1000	25x40	2.24	110	200
200	1000	30x30	2.24	110	200
200	1000	30x35	2.50	110	200
200	1000	35x30	2.50	110	200
200	1200	25x50	2.95	89	170
200	1200	30x35	2.70	89	170
200	1200	30x40	2.95	89	170
200	1200	35x30	2.95	89	170
200	1200	35x35	3.13	89	170
200	1500	30x50	3.20	68	130
200	1500	35x40	3.20	68	130
200	1800	30x50	3.30	58	110
200	1800	35x40	3.30	58	110
200	1800	35x45	3.55	58	110
200	2200	35x45	3.85	48	90
200	2200	35x50	4.00	48	90
200	2700	35x55	4.30	39	74
220	150	20x20	0.71	700	1330
220	180	22x20	0.77	580	1110
220	220	20x30	1.07	470	900
220	220	22x25	1.07	470	900
220	270	20x35	1.16	390	740
220	270	22x30	1.17	390	740
220	270	25x25	1.18	390	740
220	330	20x35	1.27	320	600
220	330	22x35	1.28	320	600
220	330	25x25	1.28	320	600
220	330	30x20	1.30	320	600
220	390	20x40	1.35	270	510
220	390	22x35	1.41	270	510
220	390	25x30	1.42	270	510
220	470	20x45	1.63	220	420
220	470	22x40	1.65	220	420
220	470	25x35	1.65	220	420
220	470	30x25	1.64	220	420
220	560	22x40	1.79	190	360
220	560	22x45	1.81	190	360
220	560	25x40	1.83	190	360
220	560	30x30	1.84	190	360
220	680	25x45	2.23	150	290
220	680	30x35	2.23	150	290
220	680	35x25	2.23	150	290
220	820	25x50	2.25	130	240
220	820	30x40	2.25	130	240
220	820	35x30	2.25	130	240
220	1000	25x55	2.28	110	200
220	1000	30x45	2.28	110	200
220	1000	35x35	2.28	110	200
220	1200	30x50	2.32	89	170
220	1200	35x40	2.32	89	170
220	1500	30x55	3.13	68	130
220	1500	35x45	3.23	68	130
220	1800	35x50	3.89	58	110
220	2200	35x60	3.95	48	90
250	150	20x20	0.67	700	1330

WV (Vdc)	Cap (uF)	Size (mm)	Rated Ripple current (Arms/105°C /120Hz)	Typ. ESR 20°C 120Hz (mΩ)	MAX ESR 20°C 120Hz (mΩ)
250	150	22x25	0.76	700	1330
250	150	25x20	0.77	700	1330
250	180	22x25	0.79	580	1110
250	180	25x25	0.91	580	1110
250	220	22x25	1.11	470	900
250	220	25x25	1.12	470	900
250	270	22x30	1.22	390	740
250	270	25x30	1.25	390	740
250	270	30x25	1.25	390	740
250	330	22x35	1.44	320	600
250	330	25x25	1.43	320	600
250	330	25x30	1.45	320	600
250	330	30x25	1.45	320	600
250	390	22x35	1.72	270	510
250	390	22x40	1.75	270	510
250	390	25x35	1.77	270	510
250	390	30x25	1.78	270	510
250	470	22x40	1.85	220	420
250	470	22x45	1.86	220	420
250	470	25x40	1.87	220	420
250	470	30x35	1.88	220	420
250	470	35x30	1.89	220	420
250	560	22x45	2.16	190	360
250	560	25x45	2.17	190	360
250	560	30x30	2.18	190	360
250	560	35x25	2.19	190	360
250	680	22x50	2.25	150	290
250	680	25x40	2.25	150	290
250	680	30x30	2.25	150	290
250	680	30x35	2.40	150	290
250	680	35x30	2.40	150	290
250	820	25x50	2.52	130	240
250	820	30x40	2.52	130	240
250	820	35x35	2.52	130	240
250	1000	30x40	2.75	110	200
250	1000	30x50	2.88	110	200
250	1000	35x40	2.88	110	200
250	1200	30x50	3.15	89	170
250	1200	30x60	3.35	89	170
250	1200	35x45	3.28	89	170
250	1500	35x45	3.76	68	130
250	1800	35x50	4.06	58	110
315	68	22x20	0.48	1540	2930
315	82	22x20	0.52	1280	2430
315	100	25x20	0.58	1050	1990
315	120	22x25	0.76	870	1660
315	120	30x20	0.77	870	1660
315	150	22x30	0.83	700	1330
315	150	25x25	0.85	700	1330
315	150	30x20	0.86	700	1330
315	180	22x30	0.93	580	1110
315	180	25x25	0.95	580	1110
315	220	22x40	1.17	470	900
315	220	25x30	1.14	470	900
315	220	30x25	1.14	470	900
315	270	22x45	1.28	390	740
315	270	25x35	1.26	390	740
315	270	30x25	1.27	390	740
315	330	22x50	1.49	320	600
315	330	25x40	1.49	320	600

WV (Vdc)	Cap (uF)	Size (mm)	Rated Ripple current (Arms/105°C /120Hz)	Typ. ESR 20°C 120Hz (mΩ)	MAX ESR 20°C 120Hz (mΩ)
315	330	30x30	1.49	320	600
315	330	35x25	1.49	320	600
315	390	25x45	1.86	270	510
315	390	30x35	1.86	270	510
315	390	35x30	1.86	270	510
315	470	25x50	1.96	220	420
315	470	30x40	1.97	220	420
315	470	35x35	1.99	220	420
315	560	30x45	2.35	190	360
315	560	35x35	2.36	190	360
315	680	30x50	2.37	150	290
315	680	35x40	2.37	150	290
315	820	35x45	2.38	130	240
315	1000	35x45	2.46	110	200
350	56	22x20	0.42	1870	3550
350	68	25x20	0.52	1540	2930
350	82	25x20	0.55	1280	2430
350	100	22x30	0.71	1050	1990
350	120	25x25	0.77	870	1660
350	120	30x20	0.77	870	1660
350	150	22x30	0.87	700	1330
350	150	25x25	0.87	700	1330
350	150	30x20	0.89	700	1330
350	180	22x35	0.95	580	1110
350	180	25x30	0.96	580	1110
350	180	30x25	1.05	580	1110
350	220	22x45	1.25	470	900
350	220	25x35	1.26	470	900
350	220	35x25	1.28	470	900
350	270	22x50	1.30	390	740
350	270	25x40	1.31	390	740
350	270	30x30	1.31	390	740
350	270	35x25	1.32	390	740
350	330	25x45	1.52	320	600
350	330	30x35	1.54	320	600
350	330	35x30	1.55	320	600
350	390	25x50	1.94	270	510
350	390	30x35	1.88	270	510
350	390	35x30	1.88	270	510
350	470	25x50	2.10	220	420
350	470	30x40	2.10	220	420
350	470	35x40	2.10	220	420
350	560	30x45	2.39	190	360
350	560	35x40	2.39	190	360
350	680	30x50	2.40	150	290
350	680	35x40	2.41	150	290
350	820	35x45	2.45	130	240
385	33	22x20	0.20	3170	6030
385	39	20x20	0.35	2680	5100
385	56	22x20	0.43	1870	3550
385	68	22x25	0.52	1540	2930
385	68	25x20	0.52	1540	2930
385	82	22x25	0.64	1280	2430
385	82	25x20	0.64	1280	2430
385	100	22x25	0.69	1050	1990
385	100	22x30	0.75	1050	1990
385	100	25x25	0.75	1050	1990
385	120	22x35	0.80	870	1660
385	120	25x25	0.80	870	1660
385	120	30x20	0.80	870	1660

WV (Vdc)	Cap (uF)	Size (mm)	Rated Ripple current (Arms/105°C /120Hz)	Typ. ESR 20°C 120Hz (mΩ)	MAX ESR 20°C 120Hz (mΩ)
385	150	22x35	0.92	700	1330
385	150	25x35	0.92	700	1330
385	150	30x30	0.92	700	1330
385	180	22x35	1.22	580	1110
385	180	22x40	1.25	580	1110
385	180	25x30	1.32	580	1110
385	180	30x30	1.34	580	1110
385	180	35x25	1.34	580	1110
385	270	30x30	1.47	390	740
385	270	35x30	1.48	390	740
385	390	25x50	1.95	270	510
385	390	30x40	1.95	270	510
385	390	35x30	1.95	270	510
385	470	30x50	2.32	220	420
385	470	35x35	2.32	220	420
385	680	30x55	2.55	150	290
385	680	35x50	2.55	150	290
385	820	35x55	2.65	130	240
400	47	22x20	0.40	2230	4230
400	56	22x20	0.44	1870	3550
400	68	22x25	0.53	1540	2930
400	68	25x20	0.53	1540	2930
400	82	22x25	0.58	1280	2430
400	82	25x20	0.58	1280	2430
400	82	25x25	0.63	1280	2430
400	100	22x25	0.66	1050	1990
400	100	22x30	0.69	1050	1990
400	100	25x25	0.69	1050	1990
400	120	22x30	0.76	870	1660
400	120	22x35	0.81	870	1660
400	120	25x25	0.81	870	1660
400	120	25x30	0.84	870	1660
400	120	30x20	0.81	870	1660
400	120	30x25	0.84	870	1660
400	150	22x35	0.90	700	1330
400	150	22x40	0.95	700	1330
400	150	25x25	0.90	700	1330
400	150	25x30	0.95	700	1330
400	150	30x20	0.90	700	1330
400	150	30x25	0.95	700	1330
400	180	22x35	0.99	580	1110
400	180	22x40	1.05	580	1110
400	180	22x45	1.10	580	1110
400	180	25x30	1.05	580	1110
400	180	25x35	1.10	580	1110
400	180	30x30	1.05	580	1110
400	180	35x25	1.05	580	1110
400	220	22x45	1.12	470	900
400	220	22x50	1.16	470	900
400	220	25x35	1.12	470	900
400	220	25x40	1.16	470	900
400	220	25x45	1.16	470	900
400	220	30x25	1.12	470	900
400	220	30x30	1.16	470	900
400	220	30x35	1.19	470	900
400	220	35x25	1.16	470	900
400	270	22x50	1.29	390	740
400	270	25x40	1.29	390	740
400	270	25x45	1.32	390	740
400	270	25x50	1.38	390	740

WV (Vdc)	Cap (uF)	Size (mm)	Rated Ripple current (Arms/105°C /120Hz)	Typ. ESR 20°C 120Hz (mΩ)	MAX ESR 20°C 120Hz (mΩ)
400	270	30x30	1.29	390	740
400	270	30x35	1.32	390	740
400	270	35x30	1.38	390	740
400	330	25x45	1.46	320	600
400	330	25x50	1.53	320	600
400	330	30x35	1.48	320	600
400	330	30x40	1.55	320	600
400	330	35x30	1.55	320	600
400	330	35x35	1.59	320	600
400	390	25x45	1.61	270	510
400	390	30x40	1.67	270	510
400	390	30x45	1.76	270	510
400	390	35x30	1.67	270	510
400	390	35x35	1.76	270	510
400	390	35x40	1.83	270	510
400	470	30x45	1.93	220	420
400	470	30x50	2.02	220	420
400	470	35x30	1.67	220	420
400	470	35x35	1.93	220	420
400	470	35x40	2.01	220	420
400	560	30x50	2.21	190	360
400	560	35x40	2.21	190	360
400	560	35x45	2.30	190	360
400	560	35x50	2.41	190	360
400	680	30x55	2.53	150	290
400	680	35x40	2.53	150	290
400	680	35x50	2.65	150	290
400	820	35x55	2.90	130	240
400	820	35x60	2.95	170	320
400	1000	35x60	3.00	140	270
400	1200	35x70	3.12	120	220
420	47	22x20	0.40	2970	5640
420	56	22x20	0.44	2490	4740
420	68	22x25	0.54	2050	3900
420	68	25x20	0.54	2050	3900
420	82	22x25	0.58	1700	3230
420	82	25x25	0.63	1700	3230
420	100	22x25	0.66	1390	2650
420	100	22x30	0.69	1390	2650
420	100	25x25	0.69	1390	2650
420	100	30x20	0.69	1390	2650
420	120	22x30	0.76	1160	2210
420	120	22x35	0.81	1160	2210
420	120	25x25	0.81	1160	2210
420	120	25x30	0.83	1160	2210
420	120	30x25	0.83	1160	2210
420	120	35x20	0.83	1160	2210
420	150	22x35	0.90	930	1770
420	150	22x40	0.96	930	1770
420	150	25x30	0.96	930	1770
420	150	25x35	0.97	930	1770
420	150	30x25	0.97	930	1770
420	180	25x35	1.06	770	1470
420	180	30x30	1.11	770	1470
420	180	35x25	1.11	770	1470
420	220	22x45	1.11	640	1210
420	220	22x50	1.16	640	1210
420	220	25x35	1.11	640	1210
420	220	25x45	1.19	640	1210
420	220	30x30	1.12	640	1210

WV (Vdc)	Cap (uF)	Size (mm)	Rated Ripple current (Arms/105°C /120Hz)	Typ. ESR 20°C 120Hz (mΩ)	MAX ESR 20°C 120Hz (mΩ)
420	220	30x35	1.19	640	1210
420	220	35x25	1.19	640	1210
420	270	25x40	1.25	520	980
420	270	30x30	1.25	520	980
420	270	30x35	1.32	520	980
420	270	30x40	1.39	520	980
420	270	35x25	1.32	520	980
420	270	35x30	1.39	520	980
420	330	25x50	1.53	420	800
420	330	30x35	1.46	420	800
420	330	30x40	1.53	420	800
420	330	30x45	1.62	420	800
420	330	35x30	1.62	420	800
420	330	35x35	1.63	420	800
420	390	30x40	1.67	360	680
420	390	30x45	1.76	360	680
420	390	30x50	1.84	360	680
420	390	35x35	1.77	360	680
420	390	35x40	1.84	360	680
420	470	30x50	2.02	290	560
420	470	30x60	2.19	290	560
420	470	35x40	2.01	290	560
420	470	35x45	2.11	290	560
420	560	35x45	2.30	250	470
420	560	35x50	2.41	250	470
420	680	35x50	2.41	210	390
420	680	35x55	2.76	210	390
420	820	30x60	2.90	170	320
420	820	35x55	2.95	170	320
420	820	35x60	3.00	170	320
450	56	22x25	0.47	2490	4740
450	68	22x25	0.52	2050	3900
450	68	22x30	0.56	2050	3900
450	68	25x25	0.57	2050	3900
450	82	22x25	0.56	1700	3230
450	82	22x30	0.62	1700	3230
450	82	25x25	0.62	1700	3230
450	100	22x30	0.68	1390	2650
450	100	22x35	0.73	1390	2650
450	100	25x25	0.73	1390	2650
450	100	25x30	0.76	1390	2650
450	100	30x25	0.76	1390	2650
450	120	22x35	0.80	1160	2210
450	120	22x40	0.84	1160	2210
450	120	25x30	0.84	1160	2210
450	120	25x35	0.86	1160	2210
450	120	30x25	0.86	1160	2210
450	150	22x40	0.94	930	1770
450	150	22x45	0.99	930	1770
450	150	25x30	0.94	930	1770
450	150	25x35	0.99	930	1770
450	150	25x40	1.01	930	1770
450	150	30x25	0.99	930	1770
450	150	30x30	1.01	930	1770
450	150	35x25	1.01	930	1770
450	180	25x35	1.05	770	1470
450	180	25x40	1.11	770	1470
450	180	25x45	1.18	770	1470
450	180	30x30	1.12	770	1470
450	180	30x35	1.18	770	1470
450	180	35x25	1.18	770	1470

WV (Vdc)	Cap (uF)	Size (mm)	Rated Ripple current (Arms/105°C /120Hz)	Typ. ESR 20°C 120Hz (mΩ)	MAX ESR 20°C 120Hz (mΩ)
450	220	22x50	1.16	640	1210
450	220	25x40	1.16	640	1210
450	220	25x45	1.19	640	1210
450	220	25x50	1.25	640	1210
450	220	30x30	1.16	640	1210
450	220	30x35	1.19	640	1210
450	220	30x40	1.25	640	1210
450	220	35x25	1.19	640	1210
450	220	35x30	1.25	640	1210
450	270	25x50	1.38	520	980
450	270	30x30	1.18	520	980
450	270	30x35	1.32	520	980
450	270	30x40	1.39	520	980
450	270	30x45	1.46	520	980
450	270	35x30	1.40	520	980
450	270	35x35	1.47	520	980
450	330	30x40	1.54	420	800
450	330	30x45	1.62	420	800
450	330	30x50	1.69	420	800
450	330	35x35	1.63	420	800
450	330	35x40	1.70	420	800
450	390	30x50	1.84	360	680
450	390	35x40	1.86	360	680
450	390	35x45	1.92	360	680
450	470	35x40	2.01	290	560
450	470	35x45	2.11	290	560
450	560	30x60	2.39	250	470
450	560	35x50	2.41	250	470
450	560	35x55	2.51	250	470
450	680	35x50	2.65	210	390
450	680	35x55	2.76	210	390
500	39	22x25	0.36	3580	6800
500	47	22x25	0.40	2970	5640
500	56	22x30	0.47	2490	4740
500	68	22x30	0.52	2050	3900
500	68	25x25	0.53	2050	3900
500	82	22x35	0.61	1700	3230
500	82	25x30	0.62	1700	3230
500	82	30x25	0.65	1700	3230
500	100	22x40	0.71	1390	2650
500	100	25x35	0.72	1390	2650
500	100	30x25	0.70	1390	2650
500	120	22x45	0.70	1160	2210
500	120	25x35	0.70	1160	2210
500	120	30x30	0.82	1160	2210
500	120	35x30	0.91	1160	2210
500	150	22x50	0.96	930	1770
500	150	25x45	0.98	930	1770
500	150	30x35	0.98	930	1770
500	150	35x30	0.98	930	1770
500	180	25x50	1.13	770	1470
500	180	30x40	1.13	770	1470
500	180	35x30	1.13	770	1470
500	220	30x45	1.32	640	1210
500	220	35x35	1.32	640	1210
500	270	30x50	1.53	520	980
500	270	35x40	1.53	520	980
500	330	35x45	1.77	420	800
500	390	35x50	1.88	360	680
500	470	35x55	2.20	290	560

Useful life

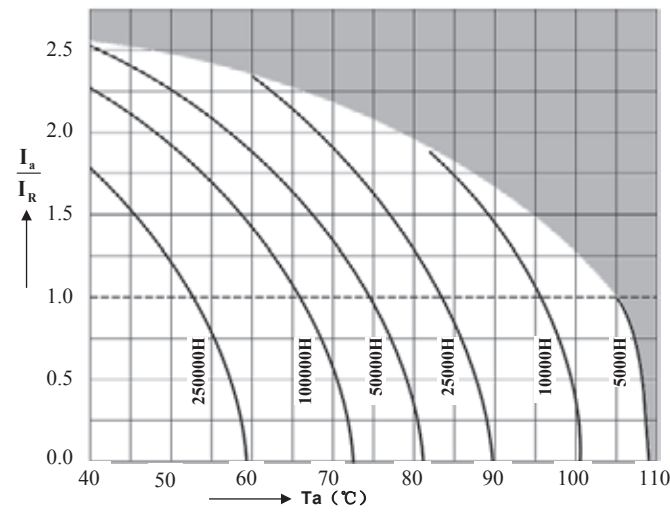

depending on ambient temperature T_a versus under ripple current operating conditions $V_R \leq 100V$

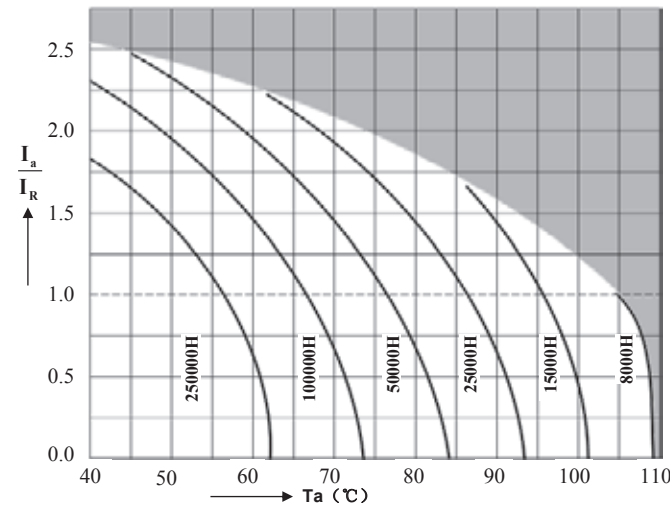

depending on ambient temperature T_a versus under ripple current operating conditions $V_R \geq 160V$

HL Series 105°C 5000H

Features

Standard capacitors

Applications

- ◆ Switch-mode power supplies in industrial and entertainment electronics
- ◆ Uninterruptible power supplies

Features

- ◆ High reliability
- ◆ Long useful life
- ◆ High ripple current capability
- ◆ Aluminum case designed explosion-proof vent
- ◆ RoHS-compatible

Construction

- ◆ Charge-discharge proof, polar
- ◆ Aluminum case with insulating sleeve
- ◆ Aluminum case designed explosion-proof vent
- ◆ Snap-in solder pins to hold component in place on PC-board



Specifications

Item	Performance Characteristics											
Operating Temperature Range	-40 to +10°C	-25 to +105°C										
Rated voltage V_R	10 to 450 V DC	500 to 550 V DC										
Surge voltage V_S	$V_R \leq 315V$ 1.15 V_R $V_R > 315V$ 1.10 V_R											
Rated capacitance C_R	39 to 56000 μF	47 to 470 μF										
Capacitance tolerance	$\pm 20\%$ (120Hz,+20°C)											
Leakage Current I_{leak} (+20°C.max.)	$I \leq 3 \sqrt{CV}$ (μA) After 5minutes with rated working voltage applied											
Dissipation Factor ($\tan \delta$, at 20°C, 120Hz)	Less than the value under table(%)											
	$\mu F/Vdc$	6.3	10	16	25	35	50	63	80	100	160~420	450~600
	≤ 8200	-	35	35	30	25	20	20	15	15	15	20
	10000 to 22000	55	40	40	35	30	30	25	15	-	-	-
≥ 27000	60	50	40	35	35	30	25	-	-	-	-	
Self-inductance ESL	approx. 20 nH											
Useful life 105°C; $V_R, I_{AC,R}$ 105°C; $V_R, I_{AC,R}$	$V_R \leq 100V$:	Requirements:										$V_R > 100V$
	>7000 h	DC/C $\leq \pm 30\%$ of initial value					ESR ≤ 3 times initial specified limit					$I_{leak} \leq$ initial specified limit
$V_R > 100V$:	>10000 h	DC/C $\leq \pm 20\%$ of initial value					ESR ≤ 2 times initial specified limit					$I_{leak} \leq$ initial specified limit
Voltage Endurance test 105°C; V_R	5000 h	Post test requirements:										
		$V_R \leq 100V$ DC/C $\leq \pm 15\%$ of initial value ESR ≤ 1.3 times initial specified limit					$V_R > 100V$ DC/C $\leq \pm 10\%$ of initial value ESR ≤ 1.3 times initial specified limit					
Shelf Life 105°C	1000 h	Post test requirements:										
		$V_R \leq 100V$ DC/C $\leq \pm 15\%$ of initial value ESR ≤ 1.3 times initial specified limit					$V_R > 100V$ DC/C $\leq \pm 10\%$ of initial value ESR ≤ 1.3 times initial specified limit					
Vibration Resistance test	To IEC 60068-2-6, test Fc:											
	Displacement amplitude 0.75 mm, frequency range 10 ... 55 Hz, acceleration max. 10 g, duration 3x2 h. Capacitor mounted by its body which is rigidly clamped to the work surface.											
Characteristics at low temperature	Max. impedance ratio at 120 Hz											
	$V_R(V)$	6.3~16	25	35	50~100	160~250	315~450	500				
	$Z_{-25^\circ C} / Z_{20^\circ C}$	4	3	3	3	3	8	8				
$Z_{-40^\circ C} / Z_{20^\circ C}$	15	10	8	6	7	10	-					
Sectional specification	IEC 60384-4 and JIS-C-5101											

Multiplier for Ripple Current vs. Frequency

$V_R(V)/$ Frequency(Hz)	50(60)	120	300	1K	10K	50K-100K
$10 \leq V_R \leq 100$	0.88	1	1.07	1.15	1.15	1.15
$160 \leq V_R \leq 250$	0.81	1	1.17	1.32	1.45	1.5
$315 \leq V_R \leq 600$	0.77	1	1.16	1.30	1.41	1.43

Dimensional drawings

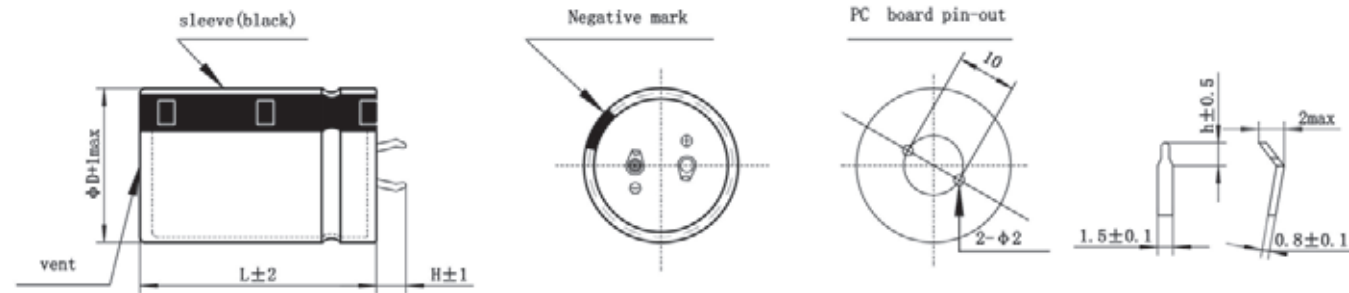

Standard snap-in terminals: length(6.0±1)mm
 Also available with length of(4.0±1)mm

H	h
6	2.5
4	1.5

Packing

Capacitor diameter D(mm)	Length L(mm)	Terminal length H(mm)	Each carton packing Qty units(pcs.)	Box/carton units(pcs.)	Each box packing Qty units(pcs.)
20	all	/	720	6	120
22	< 55	/	600	6	100
22	≥ 55	/	400	4	100
25	< 65	/	500	5	100
25	≥ 65	/	400	4	100
30	≤ 36	< 6(L=35、36)	400	8	50
30	35 ≤ L ≤ 65	≥ 6(L=35、36)	300	6	50
30	> 65	/	200	4	50
35	≤ 25	/	400	8	50
35	25 < L < 45	/	300	6	50
35	45 ≤ L ≤ 85	/	200	4	50
35	> 85	/	100	2	50
40	35	< 6	200	5	40
40	35	≥ 6	160	4	40
40	40 ≤ L ≤ 45	/	160	4	40
40	45 < L ≤ 75	/	120	3	40
40	> 75	/	80	2	40
45	40 ≤ L ≤ 65	/	140	4	35
45	65 < L ≤ 100	/	70	2	35

Packing of snap-in



Case Size

WV (Vdc)	Cap (uF)	Size (mm)	Rated Ripple current (Arms/105°C /120Hz)	Typ. ESR 20°C 120Hz (mΩ)	MAX ESR 20°C 120Hz (mΩ)
10	5600	22x25	1.10	64	83
10	6800	22x25	1.30	53	68
10	6800	25x25	1.34	53	68
10	8200	22x25	1.36	44	57
10	8200	25x25	1.56	44	57
10	10000	25x25	1.60	36	46
10	12000	25x25	1.82	34	44
10	12000	30x25	1.89	34	44
10	15000	22x40	2.10	27	35
10	15000	25x30	2.11	27	35
10	15000	30x25	2.14	27	35
10	18000	25x30	2.20	23	29
10	18000	30x30	2.37	23	29
10	22000	22x40	2.75	19	24
10	22000	25x35	2.78	19	24
10	22000	30x30	2.80	19	24
10	27000	25x45	3.01	19	25
10	27000	30x35	3.13	19	25
10	27000	35x30	3.16	19	25
10	33000	25x50	3.43	15	20
10	33000	30x40	3.53	15	20
10	33000	35x35	3.56	15	20
10	39000	30x45	3.78	13	17
10	39000	35x40	3.96	13	17
10	47000	30x50	4.61	11	14
10	47000	35x45	4.63	11	14
10	56000	35x50	5.06	9	12
16	5600	22x25	1.45	64	83
16	6800	22x30	1.66	53	68
16	6800	25x25	1.67	53	68
16	8200	22x30	1.79	44	57
16	8200	25x25	1.80	44	57
16	10000	22x35	2.08	36	46
16	10000	25x30	2.09	36	46
16	10000	30x25	2.11	36	46
16	12000	22x40	2.36	34	44
16	12000	25x35	2.37	34	44
16	12000	30x25	2.40	34	44
16	12000	35x25	2.42	34	44
16	15000	22x45	2.69	27	35
16	15000	25x35	2.70	27	35
16	15000	25x40	2.72	27	35
16	15000	30x30	2.74	27	35
16	18000	25x45	3.06	23	29
16	18000	30x35	3.08	23	29
16	18000	35x30	3.09	23	29
16	22000	25x50	3.39	19	24
16	22000	30x35	3.40	19	24
16	22000	30x40	3.46	19	24
16	22000	35x30	3.48	19	24
16	27000	25x50	3.60	15	20
16	27000	30x40	3.62	15	20
16	27000	35x30	3.65	15	20
16	27000	35x35	3.85	15	20
16	33000	30x45	4.00	12	16
16	33000	35x40	4.33	12	16
16	39000	30x50	4.32	10	14
16	39000	35x40	4.32	10	14

WV (Vdc)	Cap (uF)	Size (mm)	Rated Ripple current (Arms/105°C /120Hz)	Typ. ESR 20°C 120Hz (mΩ)	MAX ESR 20°C 120Hz (mΩ)
16	39000	35x45	4.96	10	14
16	47000	35x45	5.10	9	11
16	47000	35x50	5.49	9	11
25	3900	22x25	1.31	77	100
25	4700	22x30	1.55	65	85
25	4700	25x25	1.57	65	85
25	5600	22x30	1.80	55	71
25	5600	25x25	1.81	55	71
25	5800	22x35	1.77	53	69
25	5800	25x25	1.76	53	69
25	6800	22x30	1.90	45	59
25	6800	22x40	1.92	45	59
25	6800	25x25	1.93	45	59
25	6800	25x30	1.95	45	59
25	8200	22x35	2.10	37	49
25	8200	25x30	2.12	37	49
25	8200	30x25	2.14	37	49
25	10000	22x40	2.30	31	40
25	10000	25x35	2.31	31	40
25	10000	30x30	2.33	31	40
25	10000	35x30	2.35	31	40
25	12000	25x40	2.60	30	39
25	12000	30x35	2.70	30	39
25	12000	35x30	2.76	30	39
25	15000	25x45	2.90	24	31
25	15000	30x40	3.13	24	31
25	15000	35x35	3.16	24	31
25	18000	25x50	3.17	20	26
25	18000	30x45	3.52	20	26
25	18000	35x35	3.56	20	26
25	18000	35x40	3.60	20	26
25	22000	30x45	3.62	16	21
25	22000	30x50	3.92	16	21
25	22000	35x40	3.94	16	21
25	22000	35x45	3.95	16	21
25	27000	35x45	4.10	13	17
25	27000	35x50	4.70	13	17
25	33000	35x50	4.80	11	14
35	2200	22x25	1.10	120	150
35	2700	22x25	1.29	92	120
35	3300	22x30	1.42	77	100
35	3300	25x25	1.43	77	100
35	3900	22x30	1.60	65	85
35	3900	25x25	1.61	65	85
35	3900	25x30	1.65	65	85
35	4700	22x35	1.80	54	71
35	4700	22x40	1.81	54	71
35	4700	25x30	1.82	54	71
35	5600	22x45	2.25	46	59
35	5600	25x30	2.00	46	59
35	5600	25x35	2.18	46	59
35	5600	30x30	2.23	46	59
35	6800	25x35	2.20	38	49
35	6800	25x40	2.45	38	49
35	6800	30x30	2.46	38	49
35	8200	25x40	2.51	31	40
35	8200	25x45	2.61	31	40
35	8200	30x35	2.69	31	40

WV (Vdc)	Cap (uF)	Size (mm)	Rated Ripple current (Arms/105°C /120Hz)	Typ. ESR 20°C 120Hz (mΩ)	MAX ESR 20°C 120Hz (mΩ)
35	8200	35x30	2.71	31	40
35	10000	30x40	3.04	26	33
35	10000	35x35	3.10	26	33
35	12000	30x40	3.05	26	33
35	12000	30x45	3.38	26	33
35	12000	35x40	3.41	26	33
35	15000	30x45	3.47	20	27
35	15000	35x40	3.98	20	27
35	15000	35x45	4.10	20	27
35	18000	35x45	4.40	17	22
35	18000	35x50	4.46	17	22
50	1500	22x25	1.21	140	180
50	1800	22x25	1.30	120	150
50	1800	22x30	1.34	120	150
50	1800	25x25	1.35	120	150
50	2200	22x30	1.52	92	120
50	2200	25x25	1.54	92	120
50	2700	22x35	1.77	76	98
50	2700	25x30	1.78	76	98
50	3300	22x35	1.80	62	80
50	3300	25x30	1.87	62	80
50	3300	30x25	1.89	62	80
50	3900	22x40	1.91	52	68
50	3900	25x30	1.92	52	68
50	3900	25x35	2.20	52	68
50	4700	22x45	2.25	43	56
50	4700	25x35	2.25	43	56
50	4700	25x40	2.43	43	56
50	4700	30x30	2.44	43	56
50	4700	35x30	2.46	43	56
50	5600	22x50	2.43	36	47
50	5600	25x40	2.43	36	47
50	5600	30x35	2.60	36	47
50	5600	35x30	2.61	36	47
50	6800	25x45	2.62	30	39
50	6800	30x35	2.62	30	39
50	6800	30x40	3.01	30	39
50	6800	35x40	3.02	30	39
50	8200	30x45	3.42	25	32
50	8200	30x50	3.63	25	32
50	8200	35x40	3.64	25	32
50	10000	30x50	3.64	20	27
50	10000	35x45	3.65	20	27
50	10000	35x50	3.68	20	27
50	12000	35x45	3.70	26	33
50	15000	35x50	3.99	20	27
63	1000	22x25	1.10	210	270
63	1200	22x25	1.30	170	220
63	1500	22x30	1.31	140	180
63	1500	25x25	1.38	140	180
63	1800	22x30	1.60	120	150
63	1800	25x25	1.62	120	150
63	1800	25x30	1.63	120	150
63	1800	30x25	1.65	120	150
63	2200	22x35	1.80	92	120
63	2200	25x30	1.81	92	120
63	2200	30x25	1.82	92	120
63	2700	22x40	2.00	76	98
63	2700	25x35	2.01	76	98
63	2700	30x25	2.03	76	98

WV (Vdc)	Cap (uF)	Size (mm)	Rated Ripple current (Arms/105°C /120Hz)	Typ. ESR 20°C 120Hz (mΩ)	MAX ESR 20°C 120Hz (mΩ)
63	3300	22x45	2.20	62	80
63	3300	25x35	2.23	62	80
63	3300	30x30	2.25	62	80
63	3900	25x40	2.40	52	68
63	3900	30x35	2.41	52	68
63	3900	35x30	2.46	52	68
63	4700	25x50	2.60	43	56
63	4700	30x40	2.82	43	56
63	4700	35x30	2.75	43	56
63	5600	30x45	3.12	36	47
63	5600	35x35	3.15	36	47
63	5600	35x40	3.20	36	47
63	6800	30x50	3.21	30	39
63	6800	35x40	3.21	30	39
63	8200	35x45	3.40	25	32
63	10000	30x50	3.60	20	27
63	10000	35x50	3.80	20	27
80	820	22x25	1.09	180	240
80	1000	22x30	1.29	150	200
80	1000	25x25	1.31	150	200
80	1200	22x35	1.48	130	170
80	1200	25x25	1.50	130	170
80	1200	30x25	1.51	130	170
80	1500	22x35	1.60	100	130
80	1500	25x25	1.79	100	130
80	1500	25x30	1.80	100	130
80	1500	30x25	1.81	100	130
80	1800	22x45	1.91	85	110
80	1800	25x35	1.91	85	110
80	2200	22x45	2.00	70	90
80	2200	25x35	2.03	70	90
80	2200	30x30	2.05	70	90
80	2200	35x30	2.09	70	90
80	2700	25x40	2.20	57	74
80	2700	30x30	2.23	57	74
80	2700	35x30	2.44	57	74
80	3300	25x45	2.45	46	60
80	3300	30x35	2.45	46	60
80	3300	35x30	2.45	46	60
80	3900	30x40	2.60	39	51
80	3900	35x30	2.62	39	51
80	3900	35x40	3.00	39	51
80	4700	30x45	3.12	33	42
80	4700	35x40	3.15	33	42
80	5600	35x40	3.29	27	36
80	6800	35x45	3.50	23	29
100	390	22x25	0.78	390	510
100	560	22x25	1.10	280	360
100	560	22x30	1.11	280	360
100	560	25x26	1.12	280	360
100	680	22x30	1.20	220	290
100	680	25x30	1.21	220	290
100	820	22x35	1.33	180	240
100	820	25x30	1.40	180	240
100	1000	22x35	1.50	150	200
100	1000	22x40	1.56	150	200
100	1000	25x30	1.56	150	200
100	1000	30x25	1.57	150	200
100	1000	35x25	1.58	150	200
100	1200	22x40	1.60	130	170

WV (Vdc)	Cap (uF)	Size (mm)	Rated Ripple current (Arms/105°C /120Hz)	Typ. ESR 20°C 120Hz (mΩ)	MAX ESR 20°C 120Hz (mΩ)
100	1200	25x35	1.62	130	170
100	1200	30x25	1.64	130	170
100	1200	30x30	1.76	130	170
100	1200	35x30	1.78	130	170
100	1500	22x45	1.80	100	130
100	1500	25x40	1.82	100	130
100	1500	30x30	1.83	100	130
100	1500	35x30	1.85	100	130
100	1800	25x45	2.00	85	110
100	1800	30x35	2.01	85	110
100	1800	35x30	2.09	85	110
100	1800	35x35	2.10	85	110
100	2200	25x50	2.20	70	90
100	2200	30x40	2.23	70	90
100	2200	35x35	2.48	70	90
100	2200	35x40	2.50	70	90
100	2700	30x45	2.65	57	74
100	2700	35x35	2.69	57	74
100	2700	35x40	2.87	57	74
100	3300	30x50	2.99	46	60
100	3300	35x40	3.09	46	60
100	3300	35x45	3.25	46	60
100	3900	35x50	3.56	39	51
100	4700	35x50	3.60	33	42
160	270	22x25	1.09	380	740
160	330	22x25	1.20	310	600
160	390	22x25	1.33	260	510
160	470	22x25	1.48	220	420
160	560	22x30	1.68	180	360
160	560	25x25	1.69	180	360
160	680	22x30	1.96	150	290
160	680	25x25	1.97	150	290
160	680	30x25	1.98	150	290
160	820	22x35	2.11	120	240
160	820	25x30	2.12	120	240
160	820	30x40	2.13	120	240
160	820	35x30	2.14	120	240
160	1000	22x40	2.40	100	200
160	1000	25x35	2.43	100	200
160	1000	30x25	2.55	100	200
160	1000	35x25	2.59	100	200
160	1200	22x50	2.81	87	170
160	1200	25x40	2.85	87	170
160	1200	30x30	2.91	87	170
160	1200	35x25	2.95	87	170
160	1500	25x45	3.17	67	130
160	1500	30x35	3.23	67	130
160	1500	35x35	3.31	67	130
160	1800	25x50	3.52	56	110
160	1800	30x40	3.63	56	110
160	1800	35x30	3.66	56	110
160	2200	30x45	4.14	46	90
160	2200	35x35	4.15	46	90
160	2700	35x40	4.78	38	74
160	3300	35x50	5.42	31	60
180	220	22x25	0.63	460	900
180	270	22x30	1.10	380	740
180	270	25x25	1.11	380	740
180	330	22x35	1.21	310	600
180	330	25x30	1.22	310	600

WV (Vdc)	Cap (uF)	Size (mm)	Rated Ripple current (Arms/105°C /120Hz)	Typ. ESR 20°C 120Hz (mΩ)	MAX ESR 20°C 120Hz (mΩ)
180	390	22x40	1.34	260	510
180	390	25x35	1.35	260	510
180	390	30x25	1.36	260	510
180	470	22x45	1.49	220	420
180	470	30x30	1.50	220	420
180	560	22x50	1.70	180	360
180	560	25x40	1.71	180	360
180	560	30x35	1.72	180	360
180	680	25x45	2.01	150	290
180	680	35x30	2.02	150	290
180	820	25x50	2.15	120	240
180	820	30x40	2.16	120	240
180	820	35x35	2.17	120	240
180	1000	30x45	2.18	100	200
180	1000	35x40	2.20	100	200
180	1200	30x50	2.25	87	170
180	1200	35x45	2.28	87	170
180	1500	35x50	3.32	67	130
200	180	22x20	0.99	570	1110
200	220	22x25	1.01	460	900
200	270	22x25	1.12	380	740
200	330	22x25	1.25	310	600
200	390	22x25	1.53	260	510
200	390	25x25	1.54	260	510
200	470	22x30	1.63	220	420
200	470	25x25	1.64	220	420
200	560	22x35	1.82	180	360
200	560	25x25	1.84	180	360
200	560	30x25	1.85	180	360
200	680	22x40	2.09	150	290
200	680	25x30	2.10	150	290
200	680	30x25	2.11	150	290
200	680	35x25	2.11	150	290
200	820	22x45	2.22	120	240
200	820	25x35	2.23	120	240
200	820	30x35	2.31	120	240
200	1000	22x50	2.61	100	200
200	1000	25x40	2.62	100	200
200	1000	30x30	2.66	100	200
200	1000	35x25	2.68	100	200
200	1200	25x45	2.88	87	170
200	1200	30x35	2.92	87	170
200	1200	35x30	2.99	87	170
200	1500	30x40	3.36	67	130
200	1500	35x35	3.38	67	130
200	1800	30x50	3.82	56	110
200	1800	35x40	3.86	56	110
200	2200	35x45	4.35	46	90
200	2700	35x50	4.89	38	74
220	270	22x25	1.13	380	740
220	330	22x30	1.29	310	600
220	390	22x30	1.64	260	510
220	390	25x25	1.65	260	510
220	470	22x35	1.68	220	420
220	470	25x30	1.69	220	420
220	560	22x40	1.88	180	360
220	560	25x35	1.90	180	360
220	560	30x30	1.91	180	360
220	680	22x45	1.95	150	290
220	680	25x35	2.18	150	290

WV (Vdc)	Cap (uF)	Size (mm)	Rated Ripple current (Arms/105°C /120Hz)	Typ. ESR 20°C 120Hz (mΩ)	MAX ESR 20°C 120Hz (mΩ)
220	680	30x35	2.19	150	290
220	680	35x25	2.20	150	290
220	820	25x40	2.35	120	240
220	820	25x45	2.48	120	240
220	820	30x40	2.50	120	240
220	820	35x30	2.51	120	240
220	1000	25x50	2.70	100	200
220	1000	30x45	2.71	100	200
220	1000	35x35	2.75	100	200
220	1200	30x50	2.89	87	170
220	1200	35x40	2.99	87	170
220	1500	35x45	3.42	67	130
220	1800	35x50	3.83	56	110
220	2200	35x60	3.90	46	90
250	180	22x30	1.01	570	1110
250	180	25x25	1.03	570	1110
250	220	22x25	1.30	460	900
250	220	25x25	1.32	460	900
250	330	22x30	1.32	310	600
250	330	25x25	1.33	310	600
250	390	22x35	1.55	260	510
250	390	25x30	1.56	260	510
250	390	30x25	1.57	260	510
250	470	22x40	1.69	220	420
250	470	25x30	1.71	220	420
250	560	22x45	1.92	180	360
250	560	25x35	1.92	180	360
250	560	30x25	1.93	180	360
250	560	30x30	2.00	180	360
250	560	35x25	2.20	180	360
250	680	22x50	2.23	150	290
250	680	25x40	2.25	150	290
250	680	30x30	2.27	150	290
250	680	30x35	2.30	150	290
250	680	35x25	2.31	150	290
250	820	25x45	2.32	120	240
250	820	25x50	2.40	120	240
250	820	30x35	2.41	120	240
250	820	35x30	2.46	120	240
250	1000	30x40	2.66	100	200
250	1000	35x35	2.80	100	200
250	1000	35x40	3.00	100	200
250	1200	30x45	3.00	87	170
250	1200	35x40	3.11	87	170
250	1500	35x45	3.56	67	130
250	1800	35x50	3.98	56	110
315	68	22x25	0.32	1500	2930
315	82	22x30	0.38	1250	2430
315	100	25x25	0.41	1020	1990
315	150	22x25	0.85	680	1330
315	180	22x30	1.01	570	1110
315	180	25x25	1.04	570	1110
315	220	22x35	1.10	460	900
315	220	25x25	1.20	460	900
315	220	30x25	1.25	460	900
315	270	22x40	1.25	380	740
315	270	25x30	1.26	380	740
315	270	30x30	1.27	380	740
315	330	22x45	1.32	310	600
315	330	25x35	1.32	310	600

WV (Vdc)	Cap (uF)	Size (mm)	Rated Ripple current (Arms/105°C /120Hz)	Typ. ESR 20°C 120Hz (mΩ)	MAX ESR 20°C 120Hz (mΩ)
315	330	30x25	1.32	310	600
315	330	30x30	1.34	310	600
315	330	35x25	1.38	310	600
315	390	22x50	1.59	260	510
315	390	25x40	1.61	260	510
315	390	30x40	1.62	260	510
315	390	35x30	1.63	260	510
315	470	22x60	1.71	220	420
315	470	25x45	1.75	220	420
315	470	30x35	1.78	220	420
315	470	35x30	1.79	220	420
315	560	25x50	2.22	180	360
315	560	30x40	2.25	180	360
315	560	35x30	2.32	180	360
315	560	35x35	2.35	180	360
315	680	25x60	2.53	150	290
315	680	30x45	2.53	150	290
315	680	35x35	2.55	150	290
315	680	35x40	2.56	150	290
315	820	30x50	2.79	120	240
315	820	35x40	2.88	120	240
315	820	35x45	3.00	120	240
315	1000	30x60	3.20	100	200
315	1000	35x50	3.30	100	200
315	1200	35x55	3.31	87	170
350	56	22x20	3.33	1820	3550
350	68	22x25	0.34	1500	2930
350	82	22x30	0.40	1250	2430
350	100	25x25	0.47	1020	1990
350	120	22x25	0.72	850	1660
350	150	22x30	0.87	680	1330
350	150	25x25	0.89	680	1330
350	180	22x40	1.06	570	1110
350	180	25x25	1.07	570	1110
350	180	25x30	1.08	570	1110
350	220	22x40	1.35	460	900
350	220	25x30	1.36	460	900
350	220	30x25	1.38	460	900
350	270	22x45	1.39	380	740
350	270	25x35	1.40	380	740
350	270	30x30	1.41	380	740
350	270	35x25	1.42	380	740
350	330	22x50	1.43	310	600
350	330	25x40	1.44	310	600
350	330	30x35	1.44	310	600
350	330	35x30	1.45	310	600
350	390	25x45	1.60	260	510
350	390	30x40	1.63	260	510
350	390	35x30	1.64	260	510
350	470	25x50	1.77	220	420
350	470	30x45	1.81	220	420
350	470	35x35	1.82	220	420
350	560	30x50	2.36	180	360
350	560	35x40	2.37	180	360
350	680	35x45	2.60	150	290
350	820	35x50	2.87	120	240
385	100	22x25	0.68	1020	1990
385	120	22x25	0.76	850	1660
385	120	22x30	0.86	850	1660
385	150	22x30	0.88	680	1330

WV (Vdc)	Cap (uF)	Size (mm)	Rated Ripple current (Arms/105°C /120Hz)	Typ. ESR 20°C 120Hz (mΩ)	MAX ESR 20°C 120Hz (mΩ)
385	150	25x25	0.89	680	1330
385	180	22x30	1.06	570	1110
385	180	22x40	1.07	570	1110
385	180	25x25	1.09	570	1110
385	180	25x30	1.10	570	1110
385	180	30x25	1.12	570	1110
385	220	22x35	1.34	460	900
385	220	22x45	1.45	460	900
385	220	25x30	1.39	460	900
385	220	25x35	1.45	460	900
385	220	30x30	1.40	460	900
385	220	35x25	1.41	460	900
385	270	22x45	1.45	380	740
385	270	22x50	1.50	380	740
385	270	25x35	1.45	380	740
385	270	25x40	1.50	380	740
385	270	30x30	1.50	380	740
385	270	35x30	1.58	380	740
385	330	22x50	1.55	310	600
385	330	22x55	1.61	310	600
385	330	25x40	1.56	310	600
385	330	25x45	1.64	310	600
385	330	30x30	1.61	310	600
385	330	30x35	1.65	310	600
385	330	35x25	1.66	310	600
385	330	35x30	1.70	310	600
385	390	25x45	1.70	260	510
385	390	25x50	1.78	260	510
385	390	30x35	1.70	260	510
385	390	30x40	1.80	260	510
385	390	35x30	1.72	260	510
385	390	35x35	1.82	260	510
385	470	25x55	1.90	220	420
385	470	30x40	1.86	220	420
385	470	30x45	1.90	220	420
385	470	35x35	1.92	220	420
385	470	35x40	2.10	220	420
385	560	25x60	2.45	180	360
385	560	30x45	2.39	180	360
385	560	30x50	2.45	180	360
385	560	35x35	2.43	180	360
385	560	35x45	2.52	180	360
385	680	30x50	2.64	150	290
385	680	30x55	2.77	150	290
385	680	35x40	2.72	150	290
385	680	35x50	2.80	150	290
385	820	30x60	2.85	120	240
385	820	35x50	2.88	120	240
385	820	35x55	2.98	120	240
385	1000	35x55	3.18	100	200
385	1000	35x60	3.28	100	200
400	56	22x25	0.38	1820	3550
400	68	22x25	0.51	1500	2930
400	68	25x20	0.52	1500	2930
400	82	22x25	0.56	1250	2430
400	82	25x25	0.61	1250	2430
400	100	22x25	0.62	1020	1990
400	100	22x30	0.67	1020	1990
400	100	25x25	0.68	1020	1990
400	120	22x30	0.73	850	1660

WV (Vdc)	Cap (uF)	Size (mm)	Rated Ripple current (Arms/105°C /120Hz)	Typ. ESR 20°C 120Hz (mΩ)	MAX ESR 20°C 120Hz (mΩ)
400	120	25x25	0.74	850	1660
400	120	30x25	0.80	850	1660
400	150	22x30	0.80	680	1330
400	150	25x30	0.88	680	1330
400	150	30x25	0.92	680	1330
400	180	22x35	0.96	570	1110
400	180	25x30	0.97	570	1110
400	180	30x25	1.00	570	1110
400	220	25x30	1.02	460	900
400	220	30x25	1.02	460	900
400	220	30x30	1.05	460	900
400	270	22x45	1.16	380	740
400	270	22x50	1.21	380	740
400	270	25x35	1.16	380	740
400	270	30x30	1.21	380	740
400	270	30x35	1.24	380	740
400	270	35x25	1.23	380	740
400	330	25x40	1.31	310	600
400	330	30x30	1.31	310	600
400	330	35x25	1.31	310	600
400	470	30x45	1.82	220	420
400	470	35x35	1.82	220	420
400	470	35x40	1.89	220	420
400	560	30x45	1.99	180	360
400	560	30x50	2.08	180	360
400	560	35x40	2.08	180	360
400	560	35x45	2.17	180	360
400	680	35x45	2.39	150	290
400	680	35x50	2.50	150	290
400	820	35x50	2.50	120	240
400	820	35x55	2.86	120	240
400	1200	35x60	3.16	87	170
420	39	22x25	0.34	3490	6800
420	68	25x25	0.55	2000	3900
420	82	22x25	0.56	1660	3230
420	100	22x25	0.62	1360	2650
420	100	22x30	0.67	1360	2650
420	100	25x25	0.67	1360	2650
420	120	22x30	0.73	1130	2210
420	120	25x25	0.74	1130	2210
420	150	22x35	0.88	910	1770
420	150	25x30	0.89	910	1770
420	150	30x25	0.92	910	1770
420	180	22x35	0.96	750	1470
420	180	22x40	1.02	750	1470
420	180	25x30	1.01	750	1470
420	180	30x25	1.02	750	1470
420	220	22x45	1.05	620	1210
420	220	25x35	1.05	620	1210
420	220	30x30	1.05	620	1210
420	220	35x25	1.05	620	1210
420	270	22x50	1.21	500	980
420	270	25x40	1.21	500	980
420	270	30x30	1.21	500	980
420	270	30x35	1.24	500	980
420	270	35x25	1.21	500	980
420	270	35x30	1.28	500	980
420	330	25x50	1.44	410	800
420	330	30x35	1.37	410	800
420	330	35x30	1.44	410	800

WV (Vdc)	Cap (uF)	Size (mm)	Rated Ripple current (Arms/105°C /120Hz)	Typ. ESR 20°C 120Hz (mΩ)	MAX ESR 20°C 120Hz (mΩ)
420	470	30x45	1.82	290	560
420	470	35x40	1.89	290	560
420	560	30x55	2.17	240	470
420	560	35x45	2.17	240	470
420	680	30x60	2.48	200	390
420	680	35x50	2.50	200	390
420	820	35x55	2.91	160	320
420	820	35x60	2.97	160	320
420	1000	35x60	3.28	140	270
450	39	22x25	0.37	3490	6800
450	47	22x25	0.38	2890	5640
450	56	22x25	0.45	2430	4740
450	68	22x30	0.55	2000	3900
450	68	25x25	0.55	2000	3900
450	82	22x25	0.56	1660	3230
450	82	22x30	0.61	1660	3230
450	82	25x30	0.65	1660	3230
450	100	22x30	0.67	1360	2650
450	100	25x25	0.67	1360	2650
450	100	30x25	0.75	1360	2650
450	120	22x35	0.75	1130	2210
450	120	25x30	0.75	1130	2210
450	120	30x30	0.88	1130	2210
450	150	22x40	0.93	910	1770
450	150	25x25	0.88	910	1770
450	150	30x30	0.99	910	1770
450	150	35x30	1.08	910	1770
450	180	22x45	1.10	750	1470
450	180	25x35	1.10	750	1470
450	180	30x30	1.10	750	1470
450	180	35x25	1.11	750	1470
450	220	25x35	1.13	620	1210
450	220	30x30	1.13	620	1210
450	220	30x35	1.15	620	1210
450	220	35x30	1.16	620	1210
450	270	25x45	1.24	500	980
450	270	25x50	1.30	500	980

WV (Vdc)	Cap (uF)	Size (mm)	Rated Ripple current (Arms/105°C /120Hz)	Typ. ESR 20°C 120Hz (mΩ)	MAX ESR 20°C 120Hz (mΩ)
450	270	30x40	0.30	500	980
450	270	35x30	1.30	500	980
450	330	25x50	1.44	410	800
450	330	30x40	1.45	410	800
450	330	35x35	1.50	410	800
450	390	30x45	1.66	350	680
450	390	35x35	1.63	350	680
450	470	35x40	1.89	290	560
450	560	35x50	2.27	240	470
450	680	35x55	2.61	200	390
500	47	22x25	0.38	2890	5640
500	56	25x25	0.44	2430	4740
500	68	22x30	0.49	2000	3900
500	68	25x25	0.49	2000	3900
500	82	22x35	0.57	1660	3230
500	82	25x30	0.58	1660	3230
500	82	30x25	0.60	1660	3230
500	100	22x40	0.67	1360	2650
500	100	25x35	0.68	1360	2650
500	100	30x25	0.67	1360	2650
500	120	25x40	0.79	1130	2210
500	120	30x25	0.72	1130	2210
500	150	22x50	0.91	910	1770
500	150	25x45	0.93	910	1770
500	150	30x30	0.91	910	1770
500	180	25x50	1.06	750	1470
500	180	30x35	1.01	750	1470
500	180	35x30	1.05	750	1470
500	220	25x50	1.18	620	1210
500	220	30x45	1.25	620	1210
500	220	35x30	1.16	620	1210
500	270	30x50	1.44	500	980
500	270	35x35	1.36	500	980
500	330	35x40	1.62	410	800
500	390	35x50	1.83	350	680
500	470	35x55	2.15	290	560

Useful life

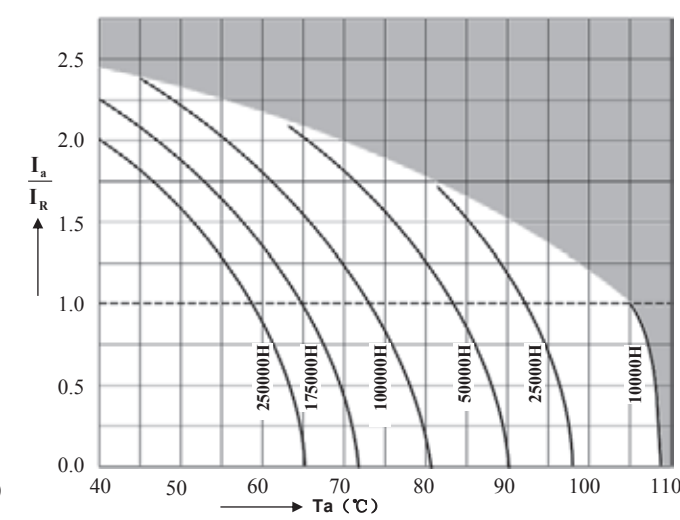
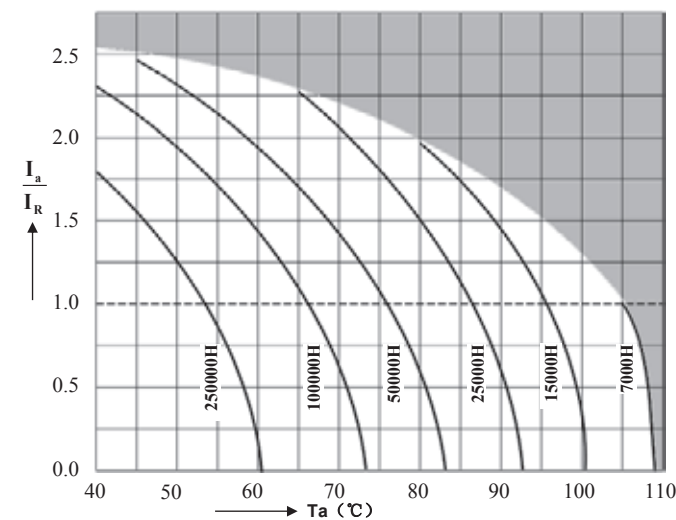

depending on ambient temperature T_a versus under ripple current operating conditions $V_R \leq 100V$

depending on ambient temperature T_a versus under ripple current operating conditions $V_R \geq 160V$

LT Series 4 Terminals Snap-in Type 85°C



Features

Applications

- ◆ Professional power supplies
- ◆ Frequency converters
- ◆ Uninterruptible power supplies
- ◆ Used for air conditioner, general-purpose inverter

Features

- ◆ High reliability
- ◆ Long useful life
- ◆ High ripple current capability
- ◆ Aluminum case designed explosion-proof vent
- ◆ RoHS-compatible

Construction

- ◆ Charge-discharge proof, polar
- ◆ Aluminum case with insulating sleeve
- ◆ Aluminum case designed explosion-proof vent
- ◆ Snap-in solder pins to hold component in place on PC-board

Specifications

Item	Performance Characteristics	
Operating Temperature Range	-40 to +85°C	-25 to +85°C
Rated voltage V_R	16 to 450 V DC	500 V DC
Surge voltage V_S	$V_R \leq 315V$ 1.15 V_R $V_R > 315V$ 1.10 V_R	
Rated capacitance C_R	330 to 82000 μF	220 to 1500 μF
Capacitance tolerance	$\pm 20\%$ (120Hz, +20°C)	
Leakage Current I_{leak} (+20°C, max.)	$I \leq 3 \sqrt{CV}$ (μA) After 5 minutes with rated working voltage applied	
Dissipation Factor ($\tan \delta$, at 20°C, 120Hz)	Less than the value under table(%)	
	$\mu F/Vdc$	16 25 35 50 63 80 100 160~420 450~500
	≤ 8200	35 30 25 20 20 15 15 15 20
	10000 to 22000	40 35 30 30 25 15 - - -
≥ 27000	40 35 35 30 25 - - - -	
Self-inductance ESL	approx. 20 nH	
Useful life 85°C; $V_R, I_{AC,R}$ 85°C; $V_R, I_{AC,R}$	$V_R \leq 100V$: >3000 h	Requirements: $V_R \leq 100V$ $\Delta C/C$ $\leq \pm 30\%$ of initial value $\tan \delta$ ≤ 3 times initial specified limit I_{leak} \leq initial specified limit
	$V_R > 100V$: >5000 h	$V_R > 100V$ $\Delta C/C$ $\leq \pm 20\%$ of initial value $\tan \delta$ ≤ 2 times initial specified limit I_{leak} \leq initial specified limit
Voltage Endurance test 85°C; V_R	2000 h	Post test requirements: $V_R \leq 100V$ $\Delta C/C$ $\leq \pm 15\%$ of initial value $\tan \delta$ ≤ 1.3 times initial specified limit I_{leak} \leq initial specified limit
		$V_R > 100V$ $\Delta C/C$ $\leq \pm 10\%$ of initial value $\tan \delta$ ≤ 1.3 times initial specified limit I_{leak} \leq initial specified limit
Shelf Life 85°C	1000 h	Post test requirements: $V_R \leq 100V$ $\Delta C/C$ $\leq \pm 15\%$ of initial value $\tan \delta$ ≤ 1.3 times initial specified limit I_{leak} \leq initial specified limit
		$V_R > 100V$ $\Delta C/C$ $\leq \pm 10\%$ of initial value $\tan \delta$ ≤ 1.3 times initial specified limit I_{leak} \leq initial specified limit
Vibration Resistance test	To IEC 60068-2-6, test Fc: Displacement amplitude 0.75 mm, frequency range 10 ... 55 Hz, acceleration max. 10 g, duration 3x2 h. Capacitor mounted by its body which is rigidly clamped to the work surface.	
Characteristics at low temperature	Max. impedance ratio at 120 Hz	
	$V_R(V)$	16 25 35~100 160~250 315~450 500~600
	$Z_{-25^\circ C} / Z_{20^\circ C}$	5 4 4 4 8 8
$Z_{-40^\circ C} / Z_{20^\circ C}$	15 15 12 7 10 -	
Sectional specification	IEC 60384-4 and JIS-C-5101	

Multiplier for Ripple Current vs. Frequency

$V_R(V)/$ Frequency(Hz)	50(60)	120	300	1K	10K	50K-100K
$10 \leq V_R \leq 100$	0.88	1	1.07	1.15	1.15	1.15
$160 \leq V_R \leq 250$	0.81	1	1.17	1.32	1.45	1.5
$315 \leq V_R \leq 600$	0.77	1	1.16	1.30	1.41	1.43

Dimensional drawings

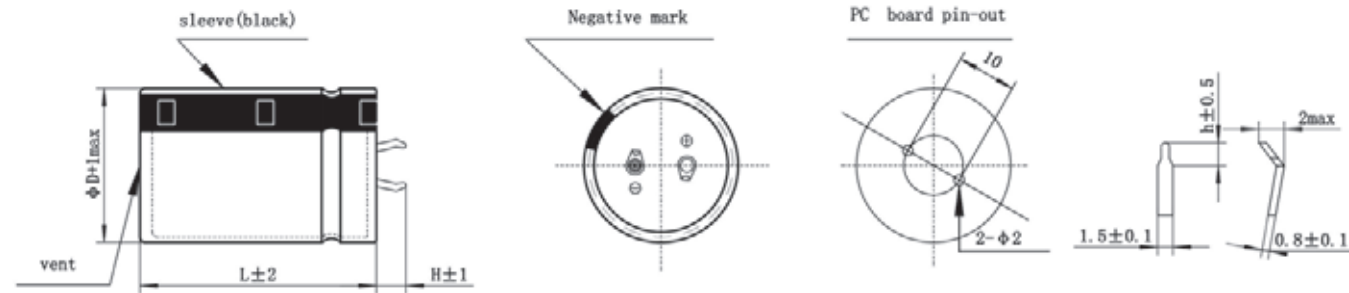

Standard snap-in terminals: length (6.0 ± 1) mm
 Also available with length of (4.0 ± 1) mm

H	h
6	2.5
4	1.5

Packing

Capacitor diameter D(mm)	Length L(mm)	Terminal length H(mm)	Each carton packing Qty units(pcs.)	Box/carton units(pcs.)	Each box packing Qty units(pcs.)
20	all	/	720	6	120
22	< 55	/	600	6	100
22	≥ 55	/	400	4	100
25	< 65	/	500	5	100
25	≥ 65	/	400	4	100
30	≤ 36	< $6(L=35, 36)$	400	8	50
30	$35 \leq L \leq 65$	$\geq 6(L=35, 36)$	300	6	50
30	> 65	/	200	4	50
35	≤ 25	/	400	8	50
35	$25 < L < 45$	/	300	6	50
35	$45 \leq L \leq 85$	/	200	4	50
35	> 85	/	100	2	50
40	35	< 6	200	5	40
40	35	≥ 6	160	4	40
40	$40 \leq L \leq 45$	/	160	4	40
40	$45 < L \leq 75$	/	120	3	40
40	> 75	/	80	2	40
45	$40 \leq L \leq 65$	/	140	4	35
45	$65 < L \leq 100$	/	70	2	35

Packing of snap-in



Case Size

WV (Vdc)	Cap (uF)	Size (mm)	Rated Ripple current (Arms/85°C /120Hz)	Typ. ESR 20°C 120Hz (mΩ)	MAX ESR 20°C 120Hz (mΩ)
16	47000	35x30	5.91	9	11
16	56000	35x60	6.51	7	10
16	56000	40x50	6.51	7	10
16	68000	35x80	7.23	6	8
16	68000	40x60	7.23	6	8
16	82000	40x80	8.19	5	7
25	33000	35x50	5.79	11	14
25	39000	35x60	6.27	9	12
25	39000	40x50	6.27	9	12
25	47000	35x80	7.11	8	10
25	47000	40x60	7.11	8	10
25	56000	40x80	7.43	6	8
25	68000	40x80	8.58	5	7
35	22000	35x50	5.01	14	18
35	27000	35x60	5.85	13	17
35	33000	35x80	6.03	11	14
35	33000	40x60	6.41	11	14
35	39000	35x80	6.94	9	12
35	39000	40x60	7.03	9	12
35	47000	40x80	7.55	8	10
50	15000	35x50	4.56	20	27
50	18000	35x60	5.10	17	22
50	18000	40x50	5.10	17	22
50	22000	35x80	5.77	14	18
50	22000	40x60	5.77	14	18
50	27000	40x60	6.19	11	15
63	12000	35x60	4.68	21	28
63	12000	40x50	4.83	21	28
63	15000	35x80	4.93	17	22
63	15000	40x60	5.03	17	22
63	18000	35x80	5.89	14	18
63	18000	40x80	6.03	14	18
80	4700	35x50	3.23	33	42
80	6800	35x50	3.65	23	29
80	8200	35x60	3.95	19	24
80	8200	40x50	3.95	19	24
80	10000	35x80	4.45	15	20
80	10000	40x60	4.45	15	20
80	12000	40x80	5.13	13	17
80	15000	40x80	5.61	10	13
100	5600	35x60	3.67	27	36
100	5600	40x50	3.67	27	36
100	6800	35x80	3.97	23	29
100	6800	40x60	3.97	23	29
100	8200	40x80	4.50	19	24
160	1800	35x50	2.49	61	110
160	2200	35x60	2.80	50	90
160	2200	40x50	2.80	50	90
160	2700	35x80	3.03	41	74
160	2700	40x60	3.03	41	74
160	3300	40x80	3.29	33	60
220	1000	35x50	2.05	110	200
220	1200	35x50	2.27	94	170
220	1500	35x60	2.47	72	130
220	1800	35x80	2.68	61	110
220	1800	40x60	2.68	61	110
220	2700	40x80	3.06	41	74
250	390	35x50	1.21	280	510

WV (Vdc)	Cap (uF)	Size (mm)	Rated Ripple current (Arms/85°C /120Hz)	Typ. ESR 20°C 120Hz (mΩ)	MAX ESR 20°C 120Hz (mΩ)
250	1000	35x60	2.13	110	200
250	1200	35x60	2.27	94	170
250	1200	40x50	2.27	94	170
250	1500	35x80	2.40	72	130
250	1500	40x60	2.40	72	130
250	1800	40x80	2.82	61	110
385	470	35x40	2.87	230	420
385	560	35x45	3.22	200	360
385	680	35x50	3.67	160	290
385	680	40x40	3.62	160	290
385	820	35x55	4.16	130	240
385	820	40x45	4.09	130	240
385	1000	35x65	4.82	110	200
385	1000	40x50	4.64	110	200
385	1000	45x40	4.48	110	200
385	1200	35x75	5.53	94	170
385	1200	40x60	5.32	94	170
385	1200	45x45	5.04	94	170
385	1500	35x90	6.57	72	130
385	1500	40x70	6.22	72	130
385	1500	45x55	5.91	72	130
385	1800	40x80	7.09	61	110
385	1800	45x60	6.60	61	110
385	2200	40x95	8.28	50	90
385	2200	45x75	7.75	50	90
385	2700	45x85	8.90	41	74
400	470	35x40	2.88	230	420
400	560	35x45	3.24	200	360
400	560	40x40	3.29	200	360
400	680	35x50	3.69	160	290
400	680	40x40	3.64	160	290
400	820	35x60	4.24	130	240
400	820	40x50	4.19	130	240
400	820	45x40	4.13	130	240
400	1000	35x70	4.90	110	200
400	1000	40x55	4.75	110	200
400	1000	45x45	4.66	110	200
400	1200	35x80	5.62	94	170
400	1200	40x60	5.35	94	170
400	1200	45x50	5.22	94	170
400	1500	35x95	6.68	72	130
400	1500	40x75	6.34	72	130
400	1500	45x55	5.94	72	130
400	1800	40x85	7.24	61	110
400	1800	45x65	6.79	61	110
400	2200	45x80	7.93	50	90
400	2700	45x90	9.11	41	74
420	390	35x40	2.47	280	510
420	470	35x45	2.80	230	420
420	560	35x50	3.15	200	360
420	560	40x40	3.15	200	360
420	680	35x55	3.60	160	290
420	680	40x45	3.57	160	290
420	820	35x65	4.13	130	240
420	820	40x50	4.03	130	240
420	820	45x40	3.96	130	240
420	1000	35x75	4.78	110	200
420	1000	40x60	4.65	110	200

WV (Vdc)	Cap (uF)	Size (mm)	Rated Ripple current (Arms/85°C /120Hz)	Typ. ESR 20°C 120Hz (mΩ)	MAX ESR 20°C 120Hz (mΩ)
420	1000	45x45	4.48	110	200
420	1200	35x85	5.49	94	170
420	1200	40x70	5.30	94	170
420	1200	45x55	5.14	94	170
420	1500	40x80	6.21	72	130
420	1500	45x65	5.99	72	130
420	1800	40x95	7.15	61	110
420	1800	45x70	6.72	61	110
420	2200	45x85	7.83	50	90
450	330	35x40	2.29	440	800
450	390	35x40	2.56	380	680
450	470	35x45	2.90	310	560
450	470	40x40	2.94	310	560
450	560	35x55	3.30	260	470
450	560	40x45	3.30	260	470
450	680	35x60	3.77	220	390
450	680	40x50	3.74	220	390
450	680	45x40	3.70	220	390
450	820	35x70	4.34	180	320
450	820	40x55	4.23	180	320
450	820	45x45	4.17	180	320
450	1000	35x80	5.04	150	270
450	1000	40x60	4.71	150	270
450	1000	40x65	4.87	150	270
450	1000	45x50	4.71	150	270
450	1200	35x95	5.82	120	220
450	1200	40x75	5.56	120	220

WV (Vdc)	Cap (uF)	Size (mm)	Rated Ripple current (Arms/85°C /120Hz)	Typ. ESR 20°C 120Hz (mΩ)	MAX ESR 20°C 120Hz (mΩ)
450	1200	45x60	5.39	120	220
450	1500	40x90	6.59	100	180
450	1500	45x70	6.28	100	180
450	1800	45x80	7.15	83	150
450	2200	45x95	8.31	67	120
500	220	35x40	1.30	670	1210
500	270	35x45	1.48	540	980
500	330	35x50	1.69	440	800
500	330	40x40	1.72	440	800
500	390	35x55	1.90	380	680
500	390	40x45	1.92	380	680
500	470	35x60	2.16	310	560
500	470	40x50	2.16	310	560
500	470	45x40	2.17	310	560
500	560	35x70	2.46	260	470
500	560	40x55	2.43	260	470
500	560	45x45	2.43	260	470
500	680	35x80	2.84	220	390
500	680	40x65	2.79	220	390
500	680	45x50	2.75	220	390
500	820	35x95	3.29	180	320
500	820	40x75	3.19	180	320
500	820	45x60	3.14	180	320
500	1000	40x85	3.69	150	270
500	1000	45x70	3.61	150	270
500	1200	45x80	4.11	120	220
500	1500	45x100	4.86	100	180

Useful life

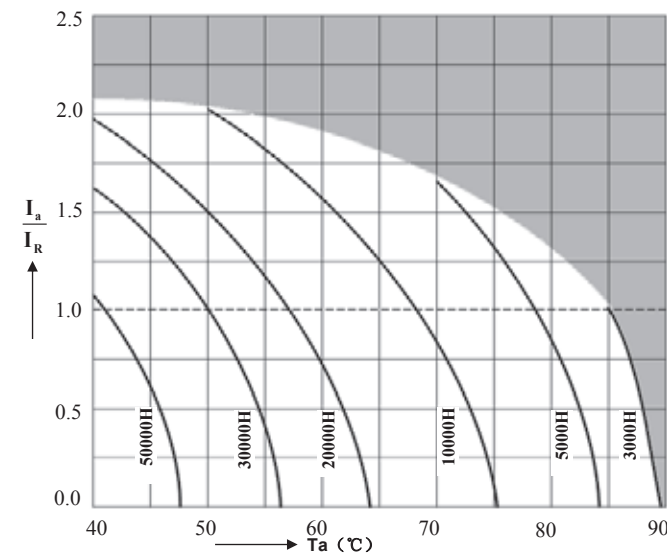

depending on ambient temperature T_a versus under ripple current operating conditions $VR \leq 100V$

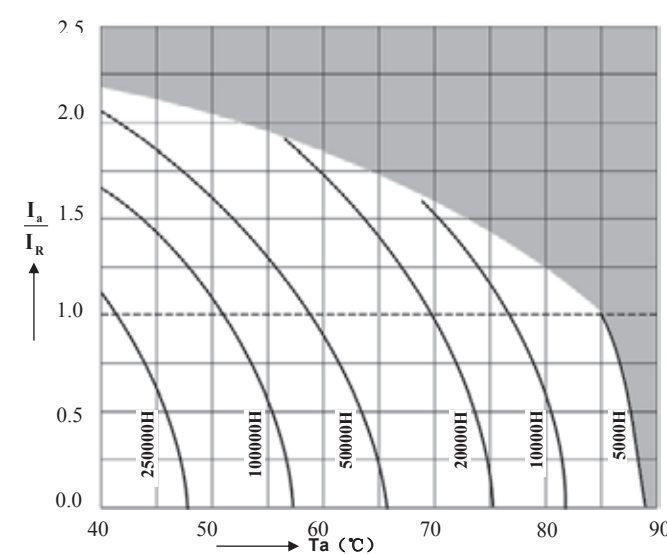

depending on ambient temperature T_a versus under ripple current operating conditions $VR \geq 160V$

HT Series 4 Terminals Snap-in Type 105°C



Features

Applications

- ◆ Professional power supplies
- ◆ Frequency converters
- ◆ Uninterruptible power supplies
- ◆ Used for air conditioner, general-purpose inverter

Features

- ◆ High reliability
- ◆ Long useful life
- ◆ High ripple current capability
- ◆ Aluminum case designed explosion-proof vent
- ◆ RoHS-compatible

Construction

- ◆ Charge-discharge proof, polar
- ◆ Aluminum case with insulating sleeve
- ◆ Aluminum case designed explosion-proof vent
- ◆ Snap-in solder pins to hold component in place on PC-board

Specifications

Item	Performance Characteristics			
Operating Temperature Range	-40 to +105°C			
Rated voltage V_R	160 to 450 V DC			
Surge voltage V_S	$V_R \leq 315V$ 1.15 V_R $V_R > 315V$ 1.10 V_R			
Rated capacitance C_R	82 to 2700 μF			
Capacitance tolerance	$\pm 20\%$ (120Hz, +20°C)			
Leakage Current I_{leak} (+20°C, max.)	$I \leq 3 \sqrt{CV}$ (μA) After 5 minutes with rated working voltage applied			
Dissipation Factor ($\tan \delta$, at 20°C, 120Hz)	Less than the value under table(%)			
	W.V.(V)	160~420	450	
	D.F.(%) max	15	20	
Self-inductance ESL	approx. 20 nH			
Useful life 105°C; $V_R, I_{AC,R}$	>5000 h	Requirements:		
		$\Delta C/C$	$\leq \pm 20\%$ of initial value	
	$\tan \delta$	≤ 2 times initial specified limit		
	I_{leak}	\leq initial specified limit		
Voltage Endurance test 105°C; V_R	2000 h	Post test requirements:		
		$\Delta C/C$	$\leq \pm 10\%$ of initial value	
	$\tan \delta$	≤ 1.3 times initial specified limit		
	I_{leak}	\leq initial specified limit		
Shelf Life 105°C	1000 h	Post test requirements:		
		$\Delta C/C$	$\leq \pm 10\%$ of initial value	
	$\tan \delta$	≤ 1.3 times initial specified limit		
	I_{leak}	\leq initial specified limit		
Vibration Resistance test	To IEC 60068-2-6, test Fc: Displacement amplitude 0.75 mm, frequency range 10 ... 55 Hz, acceleration max. 10 g, duration 3x2 h. Capacitor mounted by its body which is rigidly clamped to the work surface.			
Characteristics at low temperature	Max. impedance ratio at 120 Hz			
	$V_R(V)$	160-250	315-450	$\geq 500 V$
	$Z_{-25^\circ C} / Z_{20^\circ C}$	4	8	8
	$Z_{-40^\circ C} / Z_{20^\circ C}$	10	14	-
Sectional specification	IEC 60384-4 and JIS-C-5101			

Multiplier for Ripple Current vs. Frequency

$V_R(V)/$ Frequency(Hz)	50(60)	120	300	1K	10K	50K-100K
$160 \leq VR \leq 250$	0.81	1	1.17	1.32	1.45	1.5
$315 \leq VR \leq 450$	0.77	1	1.16	1.30	1.41	1.43

Dimensional drawings

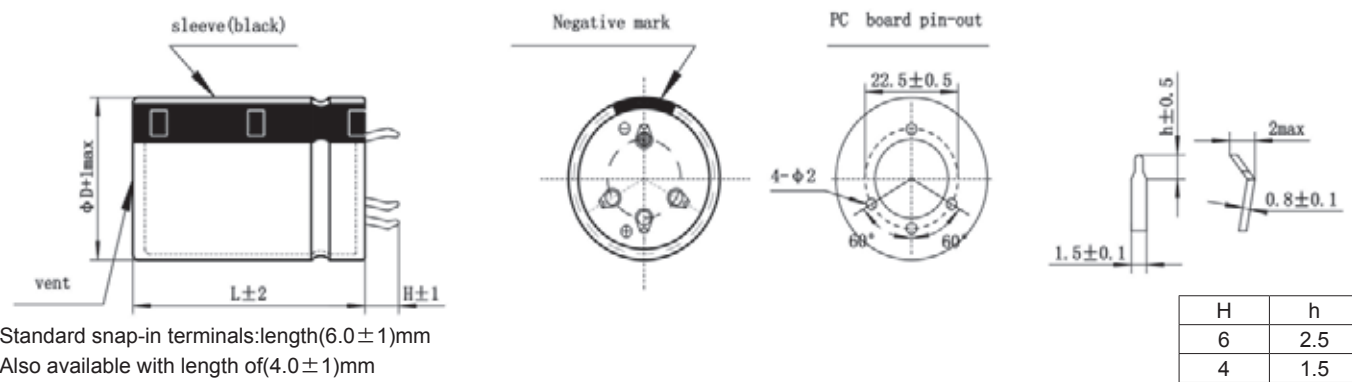

Packing

Capacitor diameter D(mm)	Length L(mm)	Terminal length H(mm)	Each carton packing Qty units(pcs.)	Box/carton units(pcs.)	Each box packing Qty units(pcs.)
20	all	/	720	6	120
22	< 55	/	600	6	100
22	≥ 55	/	400	4	100
25	< 65	/	500	5	100
25	≥ 65	/	400	4	100
30	≤ 36	< 6(L=35、36)	400	8	50
30	$35 \leq L \leq 65$	$\geq 6(L=35、36)$	300	6	50
30	> 65	/	200	4	50
35	≤ 25	/	400	8	50
35	$25 < L < 45$	/	300	6	50
35	$45 \leq L \leq 85$	/	200	4	50
35	> 85	/	100	2	50
40	35	< 6	200	5	40
40	35	≥ 6	160	4	40
40	$40 \leq L \leq 45$	/	160	4	40
40	$45 < L \leq 75$	/	120	3	40
40	> 75	/	80	2	40
45	$40 \leq L \leq 65$	/	140	4	35
45	$65 < L \leq 100$	/	70	2	35

Packing of snap-in



Case Size

WV (Vdc)	Cap (uF)	Size (mm)	Rated Ripple current (Arms/105°C /120Hz)	Typ. ESR 20°C 120Hz (mΩ)	MAX ESR 20°C 120Hz (mΩ)
160	330	30x25	1.39	310	600
160	390	30x25	1.47	260	510
160	470	30x30	1.64	220	420
160	560	30x30	1.76	180	360
160	680	30x35	1.98	150	290
160	680	35x30	1.98	150	290
160	820	30x40	2.36	120	240
160	820	35x30	2.36	120	240
160	1000	30x55	2.80	100	200
160	1000	35x35	2.60	100	200
160	1200	30x55	3.23	87	170
200	220	30x25	1.15	460	900
200	270	30x25	1.22	380	740
200	330	30x30	1.53	310	600
200	390	30x30	1.57	260	510
200	390	35x25	1.57	260	510
200	470	30x35	1.74	220	420
200	470	35x30	1.74	220	420
200	560	30x40	1.89	180	360
200	560	35x30	1.89	180	360
200	680	30x45	2.30	150	290
200	680	35x35	2.30	150	290
200	820	30x50	2.74	120	240
200	820	35x40	2.74	120	240
250	180	30x25	0.98	570	1110
250	220	30x30	1.17	460	900
250	270	30x30	1.32	380	740
250	330	30x35	1.66	310	600
250	330	35x30	1.66	310	600
250	390	30x40	1.77	260	510
250	390	35x30	1.77	260	510
250	470	30x40	1.88	220	420
250	470	35x35	1.88	220	420
250	560	30x50	2.06	180	360
250	560	35x40	2.06	180	360
350	390	35x40	1.97	260	510
350	470	35x45	2.22	220	420
350	560	35x45	2.46	180	360
350	560	40x40	2.51	180	360
350	680	35x55	2.84	150	290
350	680	40x45	2.84	150	290
350	820	35x65	3.26	120	240
350	820	40x50	3.20	120	240
350	820	45x40	3.16	120	240
350	1000	35x75	3.76	100	200
350	1000	40x60	3.68	100	200
350	1000	45x45	3.57	100	200
350	1200	35x85	4.31	87	170
350	1200	40x65	4.15	87	170
350	1200	45x50	4.00	87	170
350	1500	40x80	4.96	67	130
350	1500	45x65	4.80	67	130
350	1800	40x95	5.72	56	110
350	1800	45x75	5.45	56	110
350	2200	45x90	6.32	46	90
350	2700	45x100	7.30	38	74

WV (Vdc)	Cap (uF)	Size (mm)	Rated Ripple current (Arms/105°C /120Hz)	Typ. ESR 20°C 120Hz (mΩ)	MAX ESR 20°C 120Hz (mΩ)
400	82	30x25	0.73	1250	2430
400	100	30x30	0.82	1020	1990
400	120	30x35	0.87	850	1660
400	120	35x25	0.87	850	1660
400	150	30x40	1.00	680	1330
400	150	35x30	1.00	680	1330
400	180	30x45	1.16	570	1110
400	180	35x35	1.14	570	1110
400	220	30x50	1.28	460	900
400	220	35x40	1.28	460	900
400	330	35x40	1.83	310	600
400	390	35x45	2.05	260	510
400	470	35x45	2.32	220	420
400	470	40x40	2.33	220	420
400	560	35x55	2.60	180	360
400	560	40x45	2.61	180	360
400	560	45x40	2.60	180	360
400	680	35x65	2.99	150	290
400	680	40x50	2.95	150	290
400	680	45x40	2.93	150	290
400	820	35x75	3.43	120	240
400	820	40x60	3.37	120	240
400	820	45x45	3.30	120	240
400	1000	35x85	3.98	100	200
400	1000	40x65	3.84	100	200
400	1000	45x50	3.73	100	200
400	1200	35x100	4.59	87	170
400	1200	40x75	4.38	87	170
400	1200	45x60	4.26	87	170
400	1500	40x95	5.30	67	130
400	1500	45x70	5.05	67	130
400	1800	45x90	5.82	56	110
450	270	35x40	1.62	500	980
450	330	35x45	1.85	410	800
450	390	35x50	2.07	350	680
450	390	40x40	2.08	350	680
450	470	35x55	2.35	290	560
450	470	40x45	2.35	290	560
450	470	45x40	2.36	290	560
450	560	35x65	2.66	240	470
450	560	40x50	2.64	240	470
450	560	45x40	2.63	240	470
450	680	35x75	3.07	200	390
450	680	40x60	3.02	200	390
450	680	45x45	2.97	200	390
450	820	35x85	3.54	160	320
450	820	40x65	3.43	160	320
450	820	45x50	3.30	160	320
450	1000	35x100	4.13	140	270
450	1000	40x70	3.75	140	270
450	1000	40x80	3.98	140	270
450	1000	45x60	3.86	140	270
450	1200	40x95	4.66	110	220
450	1200	45x75	4.50	110	220
450	1500	45x90	5.30	92	180

Useful life

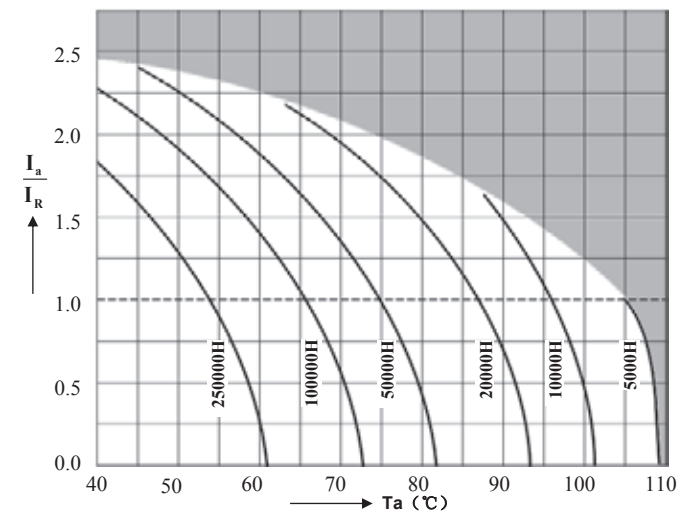

depending on ambient temperature T_a versus under ripple current operating conditions

UB Series 85°C

Features

Standard capacitors

Applications

- ◆ Professional power supplies
- ◆ Frequency converters
- ◆ Uninterruptible power supplies
- ◆ Used for air conditioner, general-purpose inverter

Features

- ◆ High reliability
- ◆ Long useful life
- ◆ High ripple current capability
- ◆ Aluminum case designed explosion-proof vent
- ◆ RoHS-compatible

Construction

- ◆ Charge-discharge proof, polar
- ◆ Aluminum case with insulating sleeve
- ◆ Aluminum case designed explosion-proof vent
- ◆ Snap-in solder pins to hold component in place on PC-board



Specifications

Item	Performance Characteristics	
Operating Temperature Range	-40 to +85°C	-25 to +85°C
Rated voltage V_R	200 to 450 V DC	500V DC
Surge voltage V_S	$V_R \leq 315V$ 1.15 V_R $V_R > 315V$ 1.10 V_R	
Rated capacitance C_R	68 ~ 3300 μF	100 ~ 1500 μF
Capacitance tolerance	$\pm 20\%$ (120Hz, +20°C)	
Leakage Current I_{leak} (+20°C, max.)	$I \leq 3 \sqrt{CV}$ (μA) After 5 minutes with rated working voltage applied	
Dissipation Factor ($\tan \delta$, at 20°C, 120Hz)	Less than the value under table(%)	
	W.V.(V)	160~420 450~550
	D.F.(%) max	15 20
Self-inductance ESL	approx. 20 nH	
Useful life 85°C; $V_R, I_{AC,R}$	>5000 h	Requirements:
		$\Delta C/C \leq \pm 20\%$ of initial value $\tan \delta \leq 2$ times initial specified limit $I_{leak} \leq$ initial specified limit
Voltage Endurance test 85°C; V_R	2000 h	Post test requirements:
		$\Delta C/C \leq \pm 10\%$ of initial value $\tan \delta \leq 1.3$ times initial specified limit $I_{leak} \leq$ initial specified limit
Shelf Life 85°C	1000 h	Post test requirements:
		$\Delta C/C \leq \pm 10\%$ of initial value $\tan \delta \leq 1.3$ times initial specified limit $I_{leak} \leq$ initial specified limit
Vibration Resistance test	To IEC 60068-2-6, test Fc: Displacement amplitude 0.75 mm, frequency range 10 ... 55 Hz, acceleration max. 10 g, duration 3x2 h. Capacitor mounted by its body which is rigidly clamped to the work surface.	
Characteristics at low temperature	Max. impedance ratio at 120 Hz	
	$V_R(V)$	200-250 V 315-450 V $\geq 500 V$
	$Z_{-25^\circ C} / Z_{20^\circ C}$	4 8 8
	$Z_{-40^\circ C} / Z_{20^\circ C}$	7 10 -
Sectional specification	IEC 60384-4 and JIS-C-5101	

Multiplier for Ripple Current vs. Frequency

$V_R(V)/$ Frequency(Hz)	50(60)	120	300	1K	10K	50K-100K
$160 \leq V_R \leq 250$	0.81	1	1.17	1.32	1.45	1.5
$315 \leq V_R \leq 600$	0.77	1	1.16	1.30	1.41	1.43

Dimensional drawings

1. Standard 2 terminals

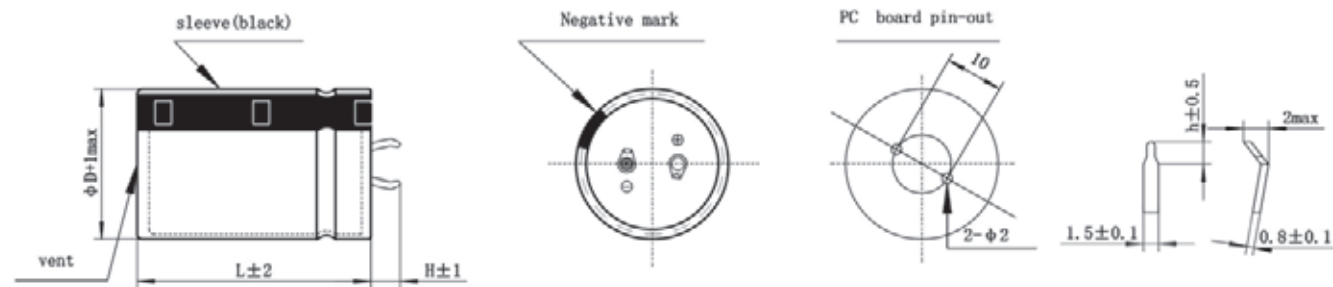

Standard snap-in terminals: length (6.0 ± 1) mm
 Also available with length of (4.0 ± 1) mm

H	h
6	2.5
4	1.5

2. Vibration proof terminal T type

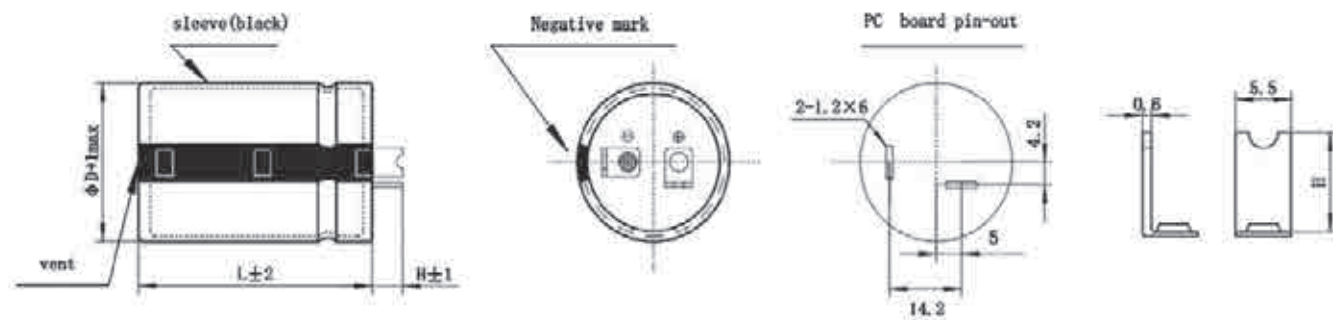

Standard terminals: Length 4.5 ± 1 mm. Also available with length of 5.5 ± 1 mm

Packing

Capacitor diameter D(mm)	Length L(mm)	Terminal length H(mm)	Each carton packing Qty units(pcs.)	Box/carton units(pcs.)	Each box packing Qty units(pcs.)
20	all	/	720	6	120
22	< 55	/	600	6	100
22	≥ 55	/	400	4	100
25	< 65	/	500	5	100
25	≥ 65	/	400	4	100
30	≤ 36	< 6(L=35、36)	400	8	50
30	$35 \leq L \leq 65$	$\geq 6(L=35、36)$	300	6	50
30	> 65	/	200	4	50
35	≤ 25	/	400	8	50
35	$25 < L < 45$	/	300	6	50
35	$45 \leq L \leq 85$	/	200	4	50
35	> 85	/	100	2	50
40	35	< 6	200	5	40
40	35	≥ 6	160	4	40
40	$40 \leq L \leq 45$	/	160	4	40
40	$45 < L \leq 75$	/	120	3	40
40	> 75	/	80	2	40
45	$40 \leq L \leq 65$	/	140	4	35
45	$65 < L \leq 100$	/	70	2	35

Packing of snap-in



Case Size

WV (Vdc)	Cap (uF)	Size (mm)	Rated Ripple current (Arms/85°C /120Hz)	Typ. ESR 20°C 120Hz (mΩ)	MAX ESR 20°C 120Hz (mΩ)
200	120	22x25	1.10	980	1660
200	220	22x25	1.15	530	900
200	270	22x30	1.30	440	740
200	330	22x30	1.50	350	600
200	330	25x25	1.50	350	600
200	390	22x35	1.65	300	510
200	390	25x30	1.70	300	510
200	470	22x40	1.95	250	420
200	470	25x30	1.80	250	420
200	470	30x25	1.90	250	420
200	560	22x45	2.15	210	360
200	560	25x35	2.12	210	360
200	560	30x30	2.20	210	360
200	560	35x20	2.10	210	360
200	680	22x45	2.35	170	290
200	680	25x40	2.40	170	290
200	680	30x35	2.50	170	290
200	680	35x20	2.32	170	290
200	820	25x40	2.65	140	240
200	820	30x35	2.73	140	240
200	820	35x25	2.82	140	240
200	1000	25x40	2.72	120	200
200	1000	30x40	3.15	120	200
200	1000	35x30	3.00	120	200
200	1200	30x45	3.50	100	170
200	1200	35x35	3.50	100	170
200	1500	25x50	3.74	76	130
200	1500	30x45	3.93	76	130
200	1500	35x40	3.93	76	130
200	1800	35x40	4.10	65	110
200	2200	35x50	4.25	53	90
200	3300	35x60	4.40	35	60
250	100	22x25	0.72	1170	1990
250	180	22x25	1.00	650	1110
250	220	22x30	1.15	530	900
250	220	25x25	1.15	530	900
250	270	22x30	1.28	440	740
250	330	22x30	1.36	350	600
250	330	25x30	1.42	350	600

WV (Vdc)	Cap (uF)	Size (mm)	Rated Ripple current (Arms/85°C /120Hz)	Typ. ESR 20°C 120Hz (mΩ)	MAX ESR 20°C 120Hz (mΩ)
250	330	30x25	1.53	350	600
250	390	22x45	1.72	300	510
250	390	25x35	1.70	300	510
250	390	30x25	1.69	300	510
250	470	22x50	2.01	250	420
250	470	25x40	1.89	250	420
250	470	30x30	1.87	250	420
250	470	35x20	1.86	250	420
250	560	25x45	2.25	210	360
250	560	30x35	2.25	210	360
250	560	35x25	2.22	210	360
250	680	25x50	2.65	170	290
250	680	30x40	2.65	170	290
250	680	35x30	2.61	170	290
250	820	30x40	2.95	140	240
250	820	35x35	2.92	140	240
250	1000	30x40	3.18	120	200
250	1000	35x35	3.25	120	200
250	1200	30x45	3.58	100	170
250	1200	35x40	3.58	100	170
250	1500	30x50	3.94	76	130
250	1500	35x45	4.30	76	130
250	1800	35x45	4.46	65	110
250	2200	35x50	4.67	53	90
315	100	22x25	0.72	1170	1990
315	150	22x30	0.90	780	1330
315	150	25x25	0.90	780	1330
315	180	22x35	1.00	650	1110
315	180	25x30	1.02	650	1110
315	220	22x40	1.15	530	900
315	220	25x35	1.18	530	900
315	220	30x25	1.12	530	900
315	270	22x45	1.23	440	740
315	270	25x40	1.35	440	740
315	270	30x30	1.33	440	740
315	270	35x25	1.38	440	740
315	330	25x45	1.60	350	600
315	330	30x35	1.60	350	600
315	390	35x30	1.70	300	510

WV (Vdc)	Cap (uF)	Size (mm)	Rated Ripple current (Arms/85°C /120Hz)	Typ. ESR 20°C 120Hz (mΩ)	MAX ESR 20°C 120Hz (mΩ)
315	470	30x45	2.09	250	420
315	470	35x35	2.03	250	420
315	560	30x50	2.30	210	360
315	560	35x40	2.27	210	360
315	680	35x45	2.36	170	290
350	82	22x25	0.70	1430	2430
350	100	22x25	0.79	1170	1990
350	120	22x30	0.84	980	1660
350	120	25x25	0.84	980	1660
350	150	22x35	0.98	780	1330
350	150	25x30	1.01	780	1330
350	180	22x40	1.18	650	1110
350	180	25x35	1.15	650	1110
350	180	30x30	1.15	650	1110
350	220	22x45	1.25	530	900
350	220	25x35	1.23	530	900
350	220	30x30	1.28	530	900
350	220	35x25	1.33	530	900
350	270	25x45	1.46	440	740
350	270	30x35	1.46	440	740
350	330	25x50	1.68	350	600
350	330	35x30	1.65	350	600
350	390	30x40	1.77	300	510
350	390	35x35	1.83	300	510
350	470	30x45	2.11	250	420
350	470	35x40	2.16	250	420
350	560	35x45	2.38	210	360
350	680	35x50	2.66	170	290
350	820	35x60	2.87	140	240
400	68	22x20	0.58	1720	2930
400	82	22x25	0.72	1430	2430
400	100	22x30	0.86	1170	1990
400	100	25x25	0.86	1170	1990
400	120	22x30	0.87	980	1660
400	120	25x25	0.87	980	1660
400	150	22x30	1.03	780	1330
400	150	25x30	1.07	780	1330
400	150	30x25	1.07	780	1330
400	180	22x45	1.20	650	1110
400	180	25x35	1.19	650	1110
400	180	30x30	1.21	650	1110
400	180	35x25	1.26	650	1110
400	220	22x50	1.69	530	900
400	220	25x40	1.69	530	900
400	220	30x30	1.69	530	900
400	220	35x25	1.62	530	900
400	270	25x40	1.70	440	740
400	270	30x35	1.80	440	740
400	270	35x30	1.80	440	740
400	330	22x50	1.82	350	600
400	330	30x40	1.90	350	600
400	330	35x35	2.00	350	600
400	390	30x40	2.05	300	510
400	390	35x35	2.17	300	510
400	470	30x50	3.03	250	420
400	470	35x40	2.95	250	420
400	470	35x45	3.11	250	420
400	560	30x50	3.33	210	360
400	560	35x40	3.28	210	360
400	560	35x45	3.39	210	360

WV (Vdc)	Cap (uF)	Size (mm)	Rated Ripple current (Arms/85°C /120Hz)	Typ. ESR 20°C 120Hz (mΩ)	MAX ESR 20°C 120Hz (mΩ)
400	560	40x40	3.42	210	360
400	680	30x60	3.81	170	290
400	680	35x45	3.71	170	290
400	680	35x50	3.85	170	290
400	680	40x40	3.78	170	290
400	820	35x55	4.19	140	240
400	820	40x50	4.26	140	240
400	820	45x40	4.22	140	240
400	1000	35x55	4.89	120	200
400	1000	40x55	4.99	120	200
400	1000	45x45	4.95	120	200
400	1200	35x80	5.67	100	170
400	1200	40x60	5.63	100	170
400	1200	40x70	5.69	100	170
400	1200	45x50	5.59	100	170
400	1500	35x95	6.70	76	130
400	1500	40x75	6.40	76	130
400	1500	45x55	6.01	76	130
400	1800	40x85	7.30	65	110
400	1800	45x65	7.15	65	110
400	2200	45x80	8.42	53	90
450	68	22x30	0.63	2290	3900
450	82	22x35	0.73	1900	3230
450	100	22x35	0.89	1560	2650
450	100	25x30	0.92	1560	2650
450	120	22x40	1.20	1300	2210
450	120	25x35	1.23	1300	2210
450	120	30x30	1.15	1300	2210
450	150	22x40	1.26	1040	1770
450	150	25x35	1.32	1040	1770
450	150	30x30	1.32	1040	1770
450	150	35x20	1.26	1040	1770
450	180	25x45	1.55	860	1470
450	180	30x35	1.55	860	1470
450	180	35x25	1.41	860	1470
450	220	25x45	1.69	710	1210
450	220	30x40	1.82	710	1210
450	220	35x30	1.73	710	1210
450	270	30x40	1.90	580	980
450	270	35x35	1.90	580	980
450	330	30x40	2.03	470	800
450	330	30x45	2.09	470	800
450	330	35x35	2.07	470	800
450	330	35x40	2.15	470	800
450	390	25x55	2.55	400	680
450	390	30x45	2.59	400	680
450	390	35x35	2.55	400	680
450	390	35x40	2.63	400	680
450	390	35x45	2.70	400	680
450	470	30x50	3.25	330	560
450	470	35x40	3.21	330	560
450	470	40x40	3.31	330	560
450	560	35x50	3.63	280	470
450	560	35x55	3.69	280	470
450	560	35x60	3.73	280	470
450	560	40x45	3.70	280	470
450	680	35x50	3.93	230	390
450	680	35x60	3.99	230	390
450	680	40x50	3.99	230	390
450	680	40x60	4.05	230	390

WV (Vdc)	Cap (uF)	Size (mm)	Rated Ripple current (Arms/85°C /120Hz)	Typ. ESR 20°C 120Hz (mΩ)	MAX ESR 20°C 120Hz (mΩ)
450	680	45x40	3.96	230	390
450	820	35x60	4.44	190	320
450	820	40x55	4.53	190	320
450	820	40x60	4.58	190	320
450	820	45x45	4.49	190	320
450	1000	35x80	5.23	160	270
450	1000	40x65	5.19	160	270
450	1000	40x70	5.26	160	270
450	1000	45x50	5.15	160	270
450	1500	40x90	6.83	110	180
450	1500	45x70	6.78	110	180
450	1800	45x80	7.39	88	150
450	2200	45x95	8.61	71	120
500	100	30x25	0.93	1560	2650
500	120	30x30	1.05	1300	2210
500	120	35x25	1.07	1300	2210
500	150	30x35	1.23	1040	1770
500	180	30x40	1.46	860	1470
500	180	35x30	1.38	860	1470
500	220	30x45	1.66	710	1210
500	220	35x35	1.57	710	1210
500	270	30x50	1.85	580	980
500	270	35x40	1.77	580	980
500	330	35x40	1.79	470	800

WV (Vdc)	Cap (uF)	Size (mm)	Rated Ripple current (Arms/85°C /120Hz)	Typ. ESR 20°C 120Hz (mΩ)	MAX ESR 20°C 120Hz (mΩ)
500	330	35x45	1.88	470	800
500	330	40x40	1.88	470	800
500	390	35x45	2.12	400	680
500	390	35x50	2.36	400	680
500	390	40x45	2.41	400	680
500	470	35x50	2.42	330	560
500	470	35x55	2.56	330	560
500	470	40x50	2.60	330	560
500	470	45x40	2.58	330	560
500	560	35x55	2.56	280	470
500	560	35x70	2.82	280	470
500	560	40x55	2.73	280	470
500	560	45x45	2.70	280	470
500	680	35x65	2.70	230	390
500	680	35x70	2.82	230	390
500	680	40x65	2.89	230	390
500	680	45x50	2.82	230	390
500	820	35x95	3.30	190	320
500	820	40x65	3.00	190	320
500	820	45x60	3.20	190	320
500	1000	40x85	3.70	160	270
500	1000	45x70	3.65	160	270
500	1200	45x80	4.15	130	220
500	1500	45x100	4.95	110	180

Useful life

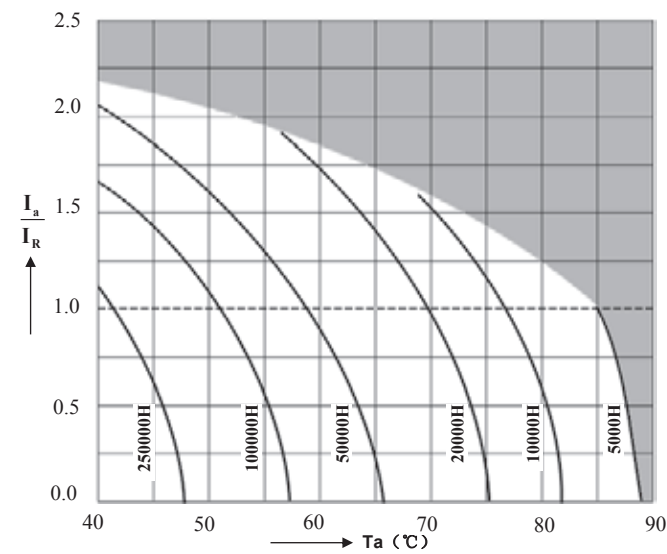

depending on ambient temperature T_a versus under ripple current operating conditions $V_R \geq 160V$

UC Series 85°C

Features

Standard capacitors

Applications

- ◆ Professional power supplies
- ◆ Frequency converters
- ◆ Uninterruptible power supplies
- ◆ Used for air conditioner, general-purpose inverter

Features

- ◆ High reliability
- ◆ Long useful life
- ◆ High ripple current capability
- ◆ Aluminum case designed explosion-proof vent
- ◆ RoHS-compatible

Construction

- ◆ Charge-discharge proof, polar
- ◆ Aluminum case with insulating sleeve
- ◆ Aluminum case designed explosion-proof vent
- ◆ Snap-in solder pins to hold component in place on PC-board



Specifications

Item	Performance Characteristics				
Operating Temperature Range	-40 to +85°C	-25 to +85°C			
Rated voltage V_R	200 to 450 V DC	500 to 630 V DC			
Surge voltage V_S	$V_R \leq 315V$ 1.15 V_R $V_R > 315V$ 1.10 V_R				
Rated capacitance C_R	68 ~ 6800 μF	56 ~ 1500 μF			
Capacitance tolerance	$\pm 20\%$ (120Hz, +20°C)				
Leakage Current I_{leak} (+20°C, max.)	$I \leq 3 \sqrt{CV}$ (μA) After 5 minutes with rated working voltage applied				
Dissipation Factor ($\tan \delta$, at 20°C, 120Hz)	Less than the value under table(%)				
	W.V.(V)	160~420 450~630			
Self-inductance ESL	approx. 20 nH				
	Useful life 85°C; $V_R, I_{AC,R}$	>7000 h			
Voltage Endurance test 85°C; V_R	3000 h	Requirements: $\Delta C/C \leq \pm 20\%$ of initial value $\tan \delta \leq 2$ times initial specified limit $I_{leak} \leq$ initial specified limit			
		Post test requirements: $\Delta C/C \leq \pm 10\%$ of initial value $\tan \delta \leq 1.3$ times initial specified limit $I_{leak} \leq$ initial specified limit			
Shelf Life 85°C	1000 h	Requirements: $\Delta C/C \leq \pm 10\%$ of initial value $\tan \delta \leq 1.3$ times initial specified limit $I_{leak} \leq$ initial specified limit			
		Post test requirements: $\Delta C/C \leq \pm 10\%$ of initial value $\tan \delta \leq 1.3$ times initial specified limit $I_{leak} \leq$ initial specified limit			
Vibration Resistance test	To IEC 60068-2-6, test Fc: Displacement amplitude 0.75 mm, frequency range 10 ... 55 Hz, acceleration max. 10 g, duration 3x2 h. Capacitor mounted by its body which is rigidly clamped to the work surface.				
Characteristics at low temperature	Max. impedance ratio at 120 Hz				
	$V_R(V)$	200-250 V	315-450 V	500 V	550-630 V
	$Z_{-25^\circ C} / Z_{20^\circ C}$	4	8	8	8
	$Z_{-40^\circ C} / Z_{20^\circ C}$	7	10	-	-
Sectional specification	IEC 60384-4 and JIS-C-5101				

For inverter

Multiplier for Ripple Current vs. Frequency

$V_R(V)/$ Frequency(Hz)	50(60)	120	300	1K	10K	50K-100K
$160 \leq VR \leq 250$	0.81	1	1.17	1.32	1.45	1.5
$315 \leq VR \leq 600$	0.77	1	1.16	1.30	1.41	1.43

Dimensional drawings

1. Standard 2 terminals

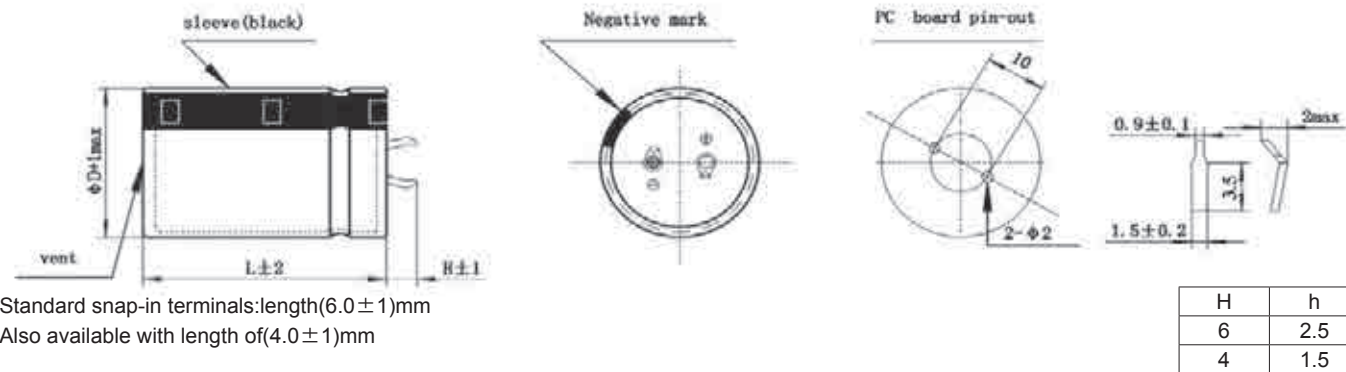

Standard snap-in terminals:length(6.0±1)mm
Also available with length of(4.0±1)mm

2. Vibration proof terminal T type

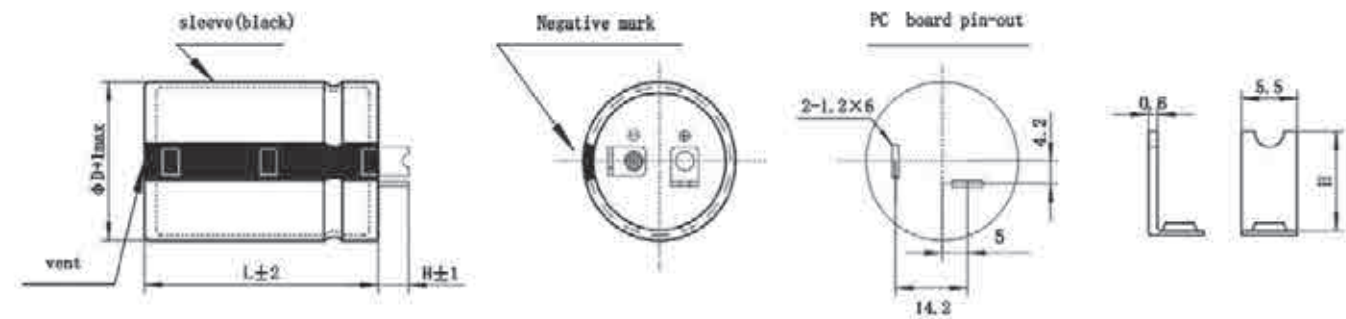

Standard terminals:Length 4.5±1mm.Also available with length of 5.5±1mm

Packing

Capacitor diameter D(mm)	Length L(mm)	Terminal length H(mm)	Each carton packing Qty units(pcs.)	Box/carton units(pcs.)	Each box packing Qty units(pcs.)
20	all	/	720	6	120
22	< 55	/	600	6	100
22	≥ 55	/	400	4	100
25	< 65	/	500	5	100
25	≥ 65	/	400	4	100
30	≤ 36	< 6(L=35、36)	400	8	50
30	35 ≤ L ≤ 65	≥ 6(L=35、36)	300	6	50
30	> 65	/	200	4	50
35	≤ 25	/	400	8	50
35	25 < L < 45	/	300	6	50
35	45 ≤ L ≤ 85	/	200	4	50
35	> 85	/	100	2	50
40	35	< 6	200	5	40
40	35	≥ 6	160	4	40
40	40 ≤ L ≤ 45	/	160	4	40
40	45 < L ≤ 75	/	120	3	40
40	> 75	/	80	2	40
45	40 ≤ L ≤ 65	/	140	4	35
45	65 < L ≤ 100	/	70	2	35

Packing of snap-in



Case Size

WV (Vdc)	Cap (uF)	Size (mm)	Rated Ripple current (Arms/85°C /120Hz)	Typ. ESR 20°C 120Hz (mΩ)	MAX ESR 20°C 120Hz (mΩ)
200	220	22x25	1.16	510	900
200	270	22x25	1.31	420	740
200	330	22x25	1.41	340	600
200	390	22x25	1.43	290	510
200	470	22x30	1.69	240	420
200	470	25x25	1.69	240	420
200	560	22x35	2.06	210	360
200	560	25x30	2.06	210	360
200	560	30x25	2.06	210	360
200	680	22x40	2.26	170	290
200	680	25x30	2.15	170	290
200	680	30x25	2.23	170	290
200	820	22x45	2.62	140	240
200	820	25x35	2.62	140	240
200	820	30x30	2.63	140	240
200	820	35x25	2.69	140	240
200	1000	22x50	2.70	110	200
200	1000	25x40	2.64	110	200
200	1000	30x30	2.63	110	200
200	1000	35x25	2.69	110	200
200	1200	25x45	2.90	97	170
200	1200	30x35	2.90	97	170
200	1200	35x30	3.00	97	170
200	1500	25x55	3.45	74	130
200	1500	30x45	3.47	74	130
200	1500	35x35	3.45	74	130
200	1800	30x50	4.00	63	110
200	1800	35x40	4.00	63	110
200	2200	30x60	4.60	52	90
200	2200	35x45	4.43	52	90
200	2200	40x40	4.52	52	90
200	2700	35x55	5.00	42	74
200	2700	40x50	5.24	42	74
200	3300	35x65	5.85	34	60
200	3300	40x60	5.91	34	60
200	3900	35x80	6.32	29	51
200	3900	40x60	6.00	29	51
200	4700	40x70	6.81	24	42
200	5600	40x80	7.45	20	36

WV (Vdc)	Cap (uF)	Size (mm)	Rated Ripple current (Arms/85°C /120Hz)	Typ. ESR 20°C 120Hz (mΩ)	MAX ESR 20°C 120Hz (mΩ)
200	6800	40x100	8.68	17	29
250	180	22x25	1.01	630	1110
250	220	22x25	1.26	510	900
250	270	22x25	1.41	420	740
250	330	22x30	1.59	340	600
250	330	25x25	1.54	340	600
250	390	22x30	1.60	290	510
250	390	25x25	1.58	290	510
250	470	22x35	1.74	240	420
250	470	25x30	1.74	240	420
250	470	30x25	1.81	240	420
250	560	22x45	2.13	210	360
250	560	25x35	2.05	210	360
250	560	30x25	2.02	210	360
250	680	22x50	2.50	170	290
250	680	25x45	2.55	170	290
250	680	30x30	2.40	170	290
250	820	25x50	2.93	140	240
250	820	30x35	2.80	140	240
250	820	35x30	2.90	140	240
250	1000	25x55	3.07	110	200
250	1000	30x45	3.12	110	200
250	1000	35x35	3.07	110	200
250	1200	25x60	3.35	97	170
250	1200	30x50	3.41	97	170
250	1200	35x35	3.21	97	170
250	1500	30x60	4.10	74	130
250	1500	35x45	3.95	74	130
250	1500	40x40	4.05	74	130
250	1800	30x65	4.30	63	110
250	1800	35x50	4.20	63	110
250	1800	40x45	4.30	63	110
250	2200	35x60	4.95	52	90
250	2200	40x50	4.95	52	90
250	2700	35x80	6.10	42	74
250	2700	40x70	6.10	42	74
250	3300	35x80	6.52	34	60
250	3300	40x70	6.61	34	60
250	3900	40x80	7.50	29	51

WV (Vdc)	Cap (uF)	Size (mm)	Rated Ripple current (Arms/85°C /120Hz)	Typ. ESR 20°C 120Hz (mΩ)	MAX ESR 20°C 120Hz (mΩ)
250	4700	40x100	8.91	24	42
350	82	22x20	0.65	1390	2430
350	100	22x25	0.78	1140	1990
350	100	25x20	0.75	1140	1990
350	120	22x25	1.00	950	1660
350	120	25x20	0.98	950	1660
350	150	22x30	1.26	760	1330
350	150	25x25	1.26	760	1330
350	180	22x35	1.30	630	1110
350	180	25x30	1.32	630	1110
350	180	30x25	1.38	630	1110
350	220	22x40	1.41	510	900
350	220	25x30	1.48	510	900
350	220	30x25	1.48	510	900
350	270	22x45	1.63	420	740
350	270	25x35	1.66	420	740
350	270	30x30	1.71	420	740
350	270	35x25	1.72	420	740
350	330	22x50	1.90	340	600
350	330	25x40	1.85	340	600
350	330	30x30	1.75	340	600
350	330	35x25	1.78	340	600
350	390	25x45	2.10	290	510
350	390	30x35	2.15	290	510
350	390	35x30	2.20	290	510
350	470	30x40	2.52	240	420
350	470	35x30	2.36	240	420
350	560	30x45	2.63	210	360
350	560	35x35	2.63	210	360
350	680	35x40	2.80	170	290
350	820	35x45	3.36	140	240
350	1000	35x60	4.60	110	200
350	1000	40x50	4.48	110	200
350	1200	35x60	4.65	97	170
350	1200	40x50	4.65	97	170
350	1500	35x80	6.10	74	130
350	1500	40x70	6.10	74	130
350	1500	45x60	6.15	74	130
350	1800	40x80	7.00	63	110
350	1800	45x70	7.00	63	110
350	2200	45x80	8.07	52	90
350	2700	45x100	9.48	42	74
400	68	22x20	0.67	1670	2930
400	82	22x25	0.81	1390	2430
400	100	22x25	0.82	1140	1990
400	100	25x20	0.80	1140	1990
400	120	22x25	1.01	950	1660
400	120	25x20	1.01	950	1660
400	150	22x25	1.40	760	1330
400	150	22x30	1.48	760	1330
400	150	25x25	1.48	760	1330
400	180	22x30	1.58	630	1110
400	180	22x35	1.65	630	1110
400	180	25x30	1.63	630	1110
400	180	30x25	1.65	630	1110
400	220	22x30	1.74	510	900
400	220	22x35	1.82	510	900
400	220	25x25	1.78	510	900
400	220	25x30	1.80	510	900
400	220	30x25	1.80	510	900

WV (Vdc)	Cap (uF)	Size (mm)	Rated Ripple current (Arms/85°C /120Hz)	Typ. ESR 20°C 120Hz (mΩ)	MAX ESR 20°C 120Hz (mΩ)
400	270	22x35	1.99	420	740
400	270	22x40	2.06	420	740
400	270	25x30	2.06	420	740
400	270	25x35	2.16	420	740
400	270	30x25	2.06	420	740
400	270	30x30	2.10	420	740
400	330	22x45	2.32	340	600
400	330	22x50	2.40	340	600
400	330	25x35	2.23	340	600
400	330	25x40	2.32	340	600
400	330	30x30	2.23	340	600
400	330	30x35	2.27	340	600
400	330	30x40	2.32	340	600
400	330	35x25	2.23	340	600
400	330	35x35	2.32	340	600
400	390	22x50	2.64	290	510
400	390	25x40	2.50	290	510
400	390	30x30	2.30	290	510
400	390	30x35	2.41	290	510
400	390	30x40	2.64	290	510
400	390	35x25	2.30	290	510
400	390	35x30	2.41	290	510
400	390	35x35	2.64	290	510
400	470	25x45	2.81	240	420
400	470	25x55	2.95	240	420
400	470	30x35	2.61	240	420
400	470	30x40	2.70	240	420
400	470	30x50	2.86	240	420
400	470	35x30	2.61	240	420
400	470	35x40	2.81	240	420
400	470	35x45	2.86	240	420
400	560	25x55	3.24	210	360
400	560	30x40	3.10	210	360
400	560	30x45	3.21	210	360
400	560	30x55	3.36	210	360
400	560	35x35	3.10	210	360
400	560	35x45	3.36	210	360
400	680	30x50	3.40	170	290
400	680	30x55	3.55	170	290
400	680	35x40	3.40	170	290
400	680	35x50	3.55	170	290
400	820	30x55	3.74	140	240
400	820	30x60	3.85	140	240
400	820	35x45	3.45	140	240
400	820	35x50	3.74	140	240
400	820	35x55	3.85	140	240
400	1000	35x55	4.60	110	200
400	1000	35x70	4.76	110	200
400	1000	40x45	4.48	110	200
400	1000	40x60	4.76	110	200
400	1000	45x40	4.48	110	200
400	1200	35x55	4.60	97	170
400	1200	35x60	4.77	97	170
400	1200	35x65	4.90	97	170
400	1200	40x60	4.95	97	170
400	1200	45x50	5.20	97	170
400	1500	35x80	6.20	74	130
400	1500	40x70	6.20	74	130
400	1500	45x60	6.20	74	130
400	1800	40x80	7.10	63	110

WV (Vdc)	Cap (uF)	Size (mm)	Rated Ripple current (Arms/85°C /120Hz)	Typ. ESR 20°C 120Hz (mΩ)	MAX ESR 20°C 120Hz (mΩ)
400	1800	45x70	7.10	63	110
400	2200	45x85	8.25	52	90
450	68	22x20	0.68	2230	3900
450	82	22x25	0.82	1850	3230
450	100	22x25	0.84	1510	2650
450	120	22x25	1.30	1260	2210
450	120	22x30	1.36	1260	2210
450	120	25x25	1.40	1260	2210
450	150	22x30	1.53	1010	1770
450	150	22x35	1.59	1010	1770
450	150	25x30	1.59	1010	1770
450	150	30x25	1.55	1010	1770
450	180	22x35	1.65	840	1470
450	180	22x40	1.71	840	1470
450	180	25x35	1.71	840	1470
450	180	30x25	1.69	840	1470
450	220	22x35	1.79	690	1210
450	220	22x40	1.88	690	1210
450	220	25x30	1.85	690	1210
450	220	30x30	1.90	690	1210
450	270	22x40	2.15	560	980
450	270	22x45	2.22	560	980
450	270	25x35	2.12	560	980
450	270	30x30	2.12	560	980
450	330	22x50	2.41	460	800
450	330	22x55	2.46	460	800
450	330	25x40	2.41	460	800
450	330	25x45	2.44	460	800
450	330	30x30	2.22	460	800
450	330	30x35	2.41	460	800
450	330	35x25	2.11	460	800
450	390	25x50	2.65	390	680
450	390	30x35	2.51	390	680
450	390	30x40	2.65	390	680
450	390	35x30	2.39	390	680
450	470	25x55	3.09	320	560
450	470	30x40	2.82	320	560
450	470	30x45	3.09	320	560
450	470	35x35	2.82	320	560
450	470	35x40	3.09	320	560
450	470	35x45	3.20	320	560
450	560	25x60	3.40	270	470
450	560	30x50	3.17	270	470
450	560	30x55	3.23	270	470
450	560	35x35	2.82	270	470
450	560	35x40	3.17	270	470
450	680	30x55	3.50	220	390
450	680	35x45	3.40	220	390
450	680	35x50	3.50	220	390
450	680	40x40	3.40	220	390
450	820	35x50	3.60	180	320
450	820	35x55	3.86	180	320
450	820	40x50	4.10	180	320
450	820	45x45	4.10	180	320
450	1000	35x55	4.60	150	270
450	1000	35x60	4.71	150	270
450	1000	40x55	4.71	150	270
450	1000	45x50	4.71	150	270
450	1200	35x80	5.52	130	220
450	1200	40x65	5.43	130	220

WV (Vdc)	Cap (uF)	Size (mm)	Rated Ripple current (Arms/85°C /120Hz)	Typ. ESR 20°C 120Hz (mΩ)	MAX ESR 20°C 120Hz (mΩ)
450	1200	45x55	5.20	130	220
450	1500	45x70	6.28	100	180
450	1800	45x80	7.10	86	150
450	2200	45x90	8.50	69	120
500	56	22x25	0.60	2710	4740
500	68	22x25	0.64	2230	3900
500	68	25x20	0.63	2230	3900
500	82	22x30	0.76	1850	3230
500	82	25x25	0.76	1850	3230
500	100	22x35	0.87	1510	2650
500	100	25x30	0.87	1510	2650
500	100	30x20	0.85	1510	2650
500	120	22x40	1.05	1260	2210
500	120	25x30	1.05	1260	2210
500	120	30x25	1.05	1260	2210
500	150	22x45	1.20	1010	1770
500	150	25x35	1.20	1010	1770
500	150	30x30	1.20	1010	1770
500	150	35x25	1.20	1010	1770
500	180	22x50	1.35	840	1470
500	180	25x40	1.31	840	1470
500	180	30x30	1.30	840	1470
500	180	35x25	1.23	840	1470
500	220	30x35	1.52	690	1210
500	220	35x30	1.55	690	1210
500	270	30x40	1.78	560	980
500	270	35x35	1.83	560	980
500	330	30x50	2.16	460	800
500	330	35x35	2.04	460	800
500	390	35x45	2.45	390	680
500	390	35x50	2.58	390	680
500	470	35x50	2.80	320	560
500	470	35x55	2.92	320	560
500	560	35x60	3.37	270	470
500	560	40x50	3.32	270	470
500	680	35x70	3.92	220	390
500	680	40x55	3.83	220	390
500	680	40x60	3.92	220	390
500	820	35x80	4.57	180	320
500	820	40x60	4.35	180	320
500	1000	40x80	5.45	150	270
500	1500	40x100	6.58	100	180
575	180	30x45	1.16	840	1470
575	220	30x50	1.31	690	1210
575	270	30x60	1.65	560	980
575	270	35x45	1.65	560	980
575	330	30x70	1.76	460	800
575	330	35x50	1.76	460	800
575	330	40x45	1.76	460	800
575	390	30x85	2.00	390	680
575	390	35x60	2.00	390	680
575	390	40x55	2.00	390	680
575	470	35x70	2.25	320	560
575	470	40x60	2.25	320	560
575	470	45x50	2.25	320	560
575	560	35x80	2.50	270	470
575	560	40x70	2.50	270	470
575	560	45x55	2.50	270	470
575	680	35x95	2.85	220	390
575	680	40x80	2.85	220	390

WV (Vdc)	Cap (uF)	Size (mm)	Rated Ripple current (Arms/85°C /120Hz)	Typ. ESR 20°C 120Hz (mΩ)	MAX ESR 20°C 120Hz (mΩ)
575	680	45x65	2.85	220	390
575	820	40x100	3.20	180	320
575	820	45x75	3.20	180	320
575	1000	45x90	3.36	150	270
575	1200	45x105	3.56	130	220
600	150	30x45	1.10	1010	1770
600	180	30x50	1.11	840	1470
600	220	30x60	1.24	690	1210
600	270	30x70	1.35	560	980
600	330	30x80	1.36	460	800
600	330	40x50	1.36	460	800
600	390	40x60	1.60	390	680
600	470	40x70	1.75	320	560
600	470	45x55	1.75	320	560
600	560	40x80	1.90	270	470
600	560	45x60	1.90	270	470
600	680	40x90	2.00	220	390

WV (Vdc)	Cap (uF)	Size (mm)	Rated Ripple current (Arms/85°C /120Hz)	Typ. ESR 20°C 120Hz (mΩ)	MAX ESR 20°C 120Hz (mΩ)
600	680	45x70	2.00	220	390
600	820	45x85	2.50	180	320
600	1000	45x100	2.90	150	270
630	150	30x45	1.00	1010	1770
630	180	30x50	1.02	840	1470
630	220	30x60	1.11	690	1210
630	270	30x70	1.30	560	980
630	330	30x85	1.33	460	800
630	330	40x50	1.33	460	800
630	470	40x70	1.70	320	560
630	470	45x55	1.70	320	560
630	560	40x80	1.80	270	470
630	560	45x65	1.80	270	470
630	680	40x95	1.95	220	390
630	680	45x75	1.95	220	390
630	820	45x90	2.30	180	320
630	1000	45x105	2.30	150	270

Useful life

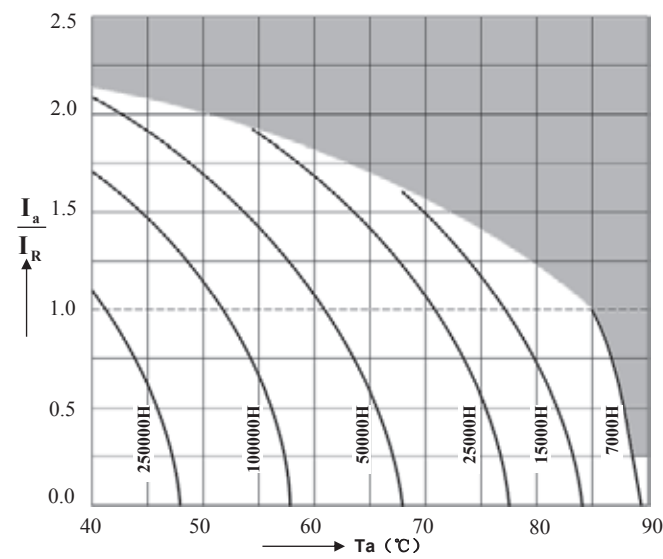

depending on ambient temperature T_a versus under ripple current operating conditions

UD Series 85°C

Features

Standard capacitors

Applications

- ◆ Professional power supplies
- ◆ Frequency converters
- ◆ Uninterruptible power supplies
- ◆ Used for air conditioner, general-purpose inverter

Features

- ◆ High reliability
- ◆ Long useful life
- ◆ High ripple current capability
- ◆ Aluminum case designed explosion-proof vent
- ◆ RoHS-compatible

Construction

- ◆ Charge-discharge proof, polar
- ◆ Aluminum case with insulating sleeve
- ◆ Aluminum case designed explosion-proof vent
- ◆ Snap-in solder pins to hold component in place on PC-board



Specifications

Item	Performance Characteristics				
Operating Temperature Range	-40 to +85°C		-25 to +85°C		
Rated voltage V_R	200 to 450 V DC		500 to 600 V DC		
Surge voltage V_S	$V_R \leq 315V$ 1.15 V_R $V_R > 315V$ 1.10 V_R				
Rated capacitance C_R	68 ~ 2700 μF		47 ~ 680 μF		
Capacitance tolerance	$\pm 20\%$ (120Hz, +20°C)				
Leakage Current I_{leak} (+20°C, max.)	$I \leq 3 \sqrt{CV}$ (μA) After 5 minutes with rated working voltage applied				
Dissipation Factor ($\tan \delta$, at 20°C, 120Hz)	Less than the value under table(%)				
	W.V.(V)	160~420	450~600		
	D.F.(%) max	15	20		
Self-inductance ESL	approx. 20 nH				
Useful life 85°C; $V_R, I_{AC,R}$	>10000 h	Requirements:			
		$\Delta C/C$	$\leq \pm 20\%$ of initial value		
		$\tan \delta$	≤ 2 times initial specified limit		
		I_{leak}	\leq initial specified limit		
Voltage Endurance test 85°C; V_R	5000 h	Post test requirements:			
		$\Delta C/C$	$\leq \pm 10\%$ of initial value		
		$\tan \delta$	≤ 1.3 times initial specified limit		
		I_{leak}	\leq initial specified limit		
Shelf Life 85°C	1000 h	Post test requirements:			
		$\Delta C/C$	$\leq \pm 10\%$ of initial value		
		$\tan \delta$	≤ 1.3 times initial specified limit		
		I_{leak}	\leq initial specified limit		
Vibration Resistance test	To IEC 60068-2-6, test Fc:				
	Displacement amplitude 0.75 mm, frequency range 10 ... 55 Hz, acceleration max. 10 g, duration 3x2 h. Capacitor mounted by its body which is rigidly clamped to the work surface.				
Characteristics at low temperature	Max. impedance ratio at 120 Hz				
	$V_R(V)$	200-250 V	315-450 V	500 V	550~600 V
	$Z_{-25^\circ C} / Z_{20^\circ C}$	4	8	8	12
	$Z_{-40^\circ C} / Z_{20^\circ C}$	7	10	-	-
Sectional specification	IEC 60384-4 and JIS-C-5101				

For inverter

Multiplier for Ripple Current vs. Frequency

$V_R(V)/$ Frequency(Hz)	50(60)	120	300	1K	10K	50K-100K
$160 \leq VR \leq 250$	0.81	1	1.17	1.32	1.45	1.5
$315 \leq VR \leq 600$	0.77	1	1.16	1.30	1.41	1.43

Dimensional drawings

1. Standard 2 terminals

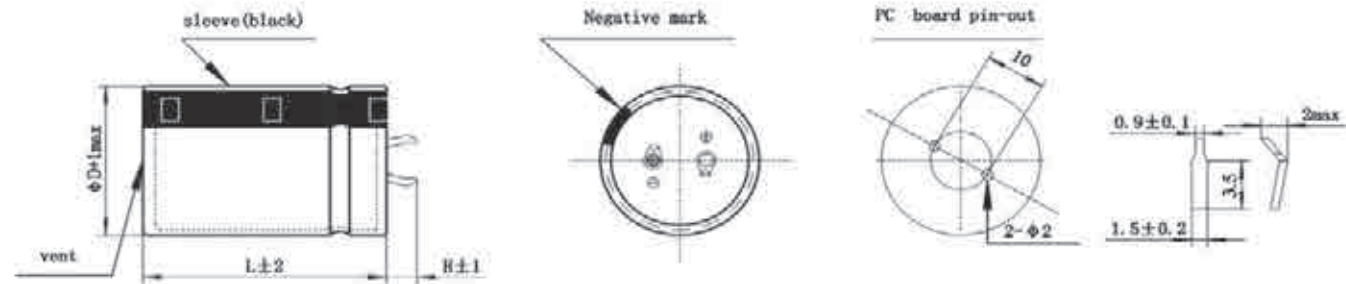

Standard snap-in terminals: length (6.0 ± 1) mm
 Also available with length of (4.0 ± 1) mm

H	h
6	2.5
4	1.5

2. Vibration proof terminal T type

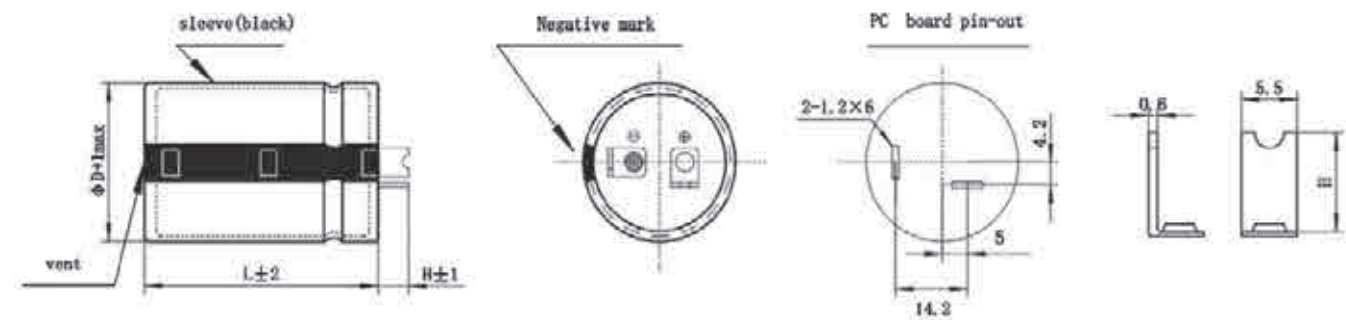

Standard terminals: Length 4.5 ± 1 mm. Also available with length of 5.5 ± 1 mm

Packing

Capacitor diameter D(mm)	Length L(mm)	Terminal length H(mm)	Each carton packing Qty units(pcs.)	Box/carton units(pcs.)	Each box packing Qty units(pcs.)
20	all	/	720	6	120
22	< 55	/	600	6	100
22	≥ 55	/	400	4	100
25	< 65	/	500	5	100
25	≥ 65	/	400	4	100
30	≤ 36	< 6(L=35、36)	400	8	50
30	$35 \leq L \leq 65$	$\geq 6(L=35、36)$	300	6	50
30	> 65	/	200	4	50
35	≤ 25	/	400	8	50
35	$25 < L < 45$	/	300	6	50
35	$45 \leq L \leq 85$	/	200	4	50
35	> 85	/	100	2	50
40	35	< 6	200	5	40
40	35	≥ 6	160	4	40
40	$40 \leq L \leq 45$	/	160	4	40
40	$45 < L \leq 75$	/	120	3	40
40	> 75	/	80	2	40
45	$40 \leq L \leq 65$	/	140	4	35
45	$65 < L \leq 100$	/	70	2	35

Packing of snap-in



Case Size

WV (Vdc)	Cap (uF)	Size (mm)	Rated Ripple current (Arms/85°C /120Hz)	Typ. ESR 20°C 120Hz (mΩ)	MAX ESR 20°C 120Hz (mΩ)
200	330	22x25	1.55	330	600
200	330	25x25	1.65	330	600
200	390	22x30	1.76	280	510
200	390	25x25	1.66	280	510
200	470	22x30	1.98	230	420
200	470	25x25	1.93	230	420
200	560	22x35	2.25	200	360
200	560	25x30	2.15	200	360
200	680	22x40	2.62	160	290
200	680	25x35	2.56	160	290
200	680	30x25	2.48	160	290
200	820	22x45	2.99	130	240
200	820	25x35	2.84	130	240
200	820	30x30	2.60	130	240
200	820	35x25	2.42	130	240
200	1000	25x45	3.29	110	200
200	1000	30x30	2.76	110	200
200	1000	35x25	2.70	110	200
200	1200	25x50	3.75	94	170
200	1200	30x35	3.54	94	170
200	1200	35x30	3.54	94	170
200	1500	30x40	3.92	72	130
200	1500	35x35	3.92	72	130
200	1800	30x50	4.75	61	110
200	1800	35x40	4.70	61	110
200	2200	30x55	5.31	50	90
200	2200	35x45	5.30	50	90
200	2700	35x50	5.48	41	74
250	150	22x25	0.95	740	1330
250	180	22x25	1.15	620	1110
250	220	22x30	1.29	500	900
250	220	25x25	1.31	500	900
250	270	22x30	1.47	410	740
250	270	25x25	1.47	410	740
250	330	22x30	1.68	330	600
250	330	25x25	1.68	330	600
250	390	22x35	2.00	280	510
250	390	25x30	1.95	280	510
250	390	30x25	2.10	280	510

WV (Vdc)	Cap (uF)	Size (mm)	Rated Ripple current (Arms/85°C /120Hz)	Typ. ESR 20°C 120Hz (mΩ)	MAX ESR 20°C 120Hz (mΩ)
250	470	22x40	2.21	230	420
250	470	25x30	2.15	230	420
250	470	35x25	2.20	230	420
250	560	22x40	2.50	200	360
250	560	25x35	2.50	200	360
250	560	30x30	2.51	200	360
250	560	35x25	2.53	200	360
250	680	22x50	2.91	160	290
250	680	25x40	2.80	160	290
250	680	30x30	2.75	160	290
250	680	35x25	2.64	160	290
250	820	25x45	3.12	130	240
250	820	30x35	3.01	130	240
250	820	35x30	3.00	130	240
250	1000	25x50	3.60	110	200
250	1000	30x40	3.46	110	200
250	1000	35x30	3.39	110	200
250	1200	30x45	3.93	94	170
250	1200	35x35	3.81	94	170
250	1500	30x50	4.52	72	130
250	1500	35x40	4.52	72	130
250	1800	35x45	5.21	61	110
250	2200	35x55	5.70	50	90
350	560	35x50	3.21	200	360
350	680	35x40	3.19	160	290
350	820	35x50	3.67	130	240
350	1000	35x55	4.23	110	200
350	1500	40x80	6.52	72	130
350	1500	45x70	6.52	72	130
350	2200	45x100	8.70	50	90
400	82	22x25	0.79	1350	2430
400	100	22x25	0.90	1110	1990
400	100	25x25	1.05	1110	1990
400	120	22x30	1.05	920	1660
400	120	25x25	1.05	920	1660
400	150	22x30	1.15	740	1330
400	150	25x25	1.15	740	1330
400	180	22x35	1.31	620	1110
400	180	25x30	1.32	620	1110

WV (Vdc)	Cap (uF)	Size (mm)	Rated Ripple current (Arms/85°C /120Hz)	Typ. ESR 20°C 120Hz (mΩ)	MAX ESR 20°C 120Hz (mΩ)
400	180	30x25	1.32	620	1110
400	220	22x40	1.55	500	900
400	220	25x35	1.52	500	900
400	220	30x25	1.51	500	900
400	220	35x25	1.55	500	900
400	270	22x45	1.80	410	740
400	270	25x40	1.76	410	740
400	270	30x30	1.76	410	740
400	270	35x25	1.72	410	740
400	330	25x45	2.05	330	600
400	330	30x35	2.02	330	600
400	330	35x25	2.01	330	600
400	390	25x50	2.33	280	510
400	390	30x35	2.18	280	510
400	390	35x30	2.24	280	510
400	470	25x55	2.68	230	420
400	470	30x40	2.65	230	420
400	470	35x35	2.59	230	420
400	560	30x45	3.00	200	360
400	560	35x35	2.98	200	360
400	680	30x55	3.51	160	290
400	680	35x40	3.20	160	290
400	680	35x45	3.42	160	290
400	820	35x50	3.72	130	240
400	1000	35x55	4.30	110	200
400	1200	35x65	4.82	94	170
400	1200	40x55	4.80	94	170
400	1500	40x80	6.62	72	130
400	1500	45x60	6.31	72	130
400	1800	45x80	7.60	61	110
450	68	22x25	0.68	2170	3900
450	82	22x25	0.81	1790	3230
450	82	25x25	0.81	1790	3230
450	100	22x30	0.94	1470	2650
450	100	30x25	0.98	1470	2650
450	120	22x30	1.05	1230	2210
450	120	25x25	1.09	1230	2210
450	150	22x35	1.21	980	1770
450	150	25x30	1.21	980	1770
450	150	30x25	1.21	980	1770
450	180	22x40	1.39	820	1470
450	180	25x35	1.39	820	1470
450	180	30x25	1.35	820	1470
450	220	22x50	1.68	670	1210
450	220	25x40	1.68	670	1210
450	220	30x30	1.62	670	1210
450	220	35x25	1.60	670	1210
450	270	25x45	1.85	540	980
450	270	30x35	1.82	540	980
450	270	35x30	1.91	540	980
450	330	25x50	2.18	440	800
450	330	30x40	2.21	440	800
450	330	35x30	2.20	440	800
450	390	30x45	2.51	380	680
450	390	35x35	2.50	380	680
450	470	30x50	2.88	310	560
450	470	35x40	2.80	310	560
450	560	30x55	3.25	260	470
450	560	35x45	3.26	260	470
450	680	35x50	3.48	220	390

WV (Vdc)	Cap (uF)	Size (mm)	Rated Ripple current (Arms/85°C /120Hz)	Typ. ESR 20°C 120Hz (mΩ)	MAX ESR 20°C 120Hz (mΩ)
450	1500	45x100	7.24	100	180
500	47	22x25	0.52	3130	5640
500	68	22x30	0.70	2170	3900
500	68	25x25	0.70	2170	3900
500	82	25x30	0.82	1790	3230
500	100	25x35	0.97	1470	2650
500	100	30x25	0.97	1470	2650
500	120	25x35	1.09	1230	2210
500	120	30x30	1.10	1230	2210
500	150	25x40	1.26	980	1770
500	150	30x30	1.30	980	1770
500	150	35x25	1.32	980	1770
500	180	25x45	1.50	820	1470
500	180	30x35	1.53	820	1470
500	180	35x30	1.55	820	1470
500	220	25x55	1.61	670	1210
500	220	30x40	1.75	670	1210
500	220	35x35	1.80	670	1210
500	270	30x45	2.01	540	980
500	270	35x35	2.03	540	980
500	330	30x55	2.32	440	800
500	330	35x40	2.32	440	800
500	390	35x45	2.63	380	680
500	470	35x55	2.99	310	560
500	560	35x65	3.24	260	470
500	680	40x60	3.90	220	390
550	56	25x25	0.66	2630	4740
550	68	25x30	0.75	2170	3900
550	82	25x35	0.84	1790	3230
550	82	30x25	0.87	1790	3230
550	100	25x35	1.01	1470	2650
550	100	30x30	1.01	1470	2650
550	120	25x40	1.12	1230	2210
550	120	30x35	1.15	1230	2210
550	120	35x25	1.15	1230	2210
550	150	25x50	1.36	980	1770
550	150	30x35	1.30	980	1770
550	150	35x30	1.45	980	1770
550	180	25x55	1.57	820	1470
550	180	30x40	1.58	820	1470
550	180	35x35	1.63	820	1470
550	220	30x50	1.87	670	1210
550	220	35x40	1.87	670	1210
550	270	30x55	2.12	540	980
550	270	35x45	2.15	540	980
550	330	35x50	2.45	440	800
550	390	35x55	2.78	380	680
600	47	25x25	0.61	3130	5640
600	56	25x30	0.68	2630	4740
600	68	25x35	0.82	2170	3900
600	68	30x25	0.82	2170	3900
600	82	25x35	0.88	1790	3230
600	82	30x30	0.92	1790	3230
600	100	25x40	1.05	1470	2650
600	100	30x35	1.07	1470	2650
600	100	35x25	1.11	1470	2650
600	120	25x50	1.19	1230	2210
600	120	30x35	1.23	1230	2210
600	120	35x30	1.31	1230	2210
600	150	25x55	1.53	980	1770

WV (Vdc)	Cap (uF)	Size (mm)	Rated Ripple current (Arms/85°C /120Hz)	Typ. ESR 20°C 120Hz (mΩ)	MAX ESR 20°C 120Hz (mΩ)
600	150	30x45	1.53	980	1770
600	150	35x35	1.53	980	1770
600	180	30x50	1.68	820	1470
600	180	35x40	1.72	820	1470

WV (Vdc)	Cap (uF)	Size (mm)	Rated Ripple current (Arms/85°C /120Hz)	Typ. ESR 20°C 120Hz (mΩ)	MAX ESR 20°C 120Hz (mΩ)
600	220	30x55	1.95	670	1210
600	220	35x45	1.95	670	1210
600	270	35x50	2.26	540	980

Useful life

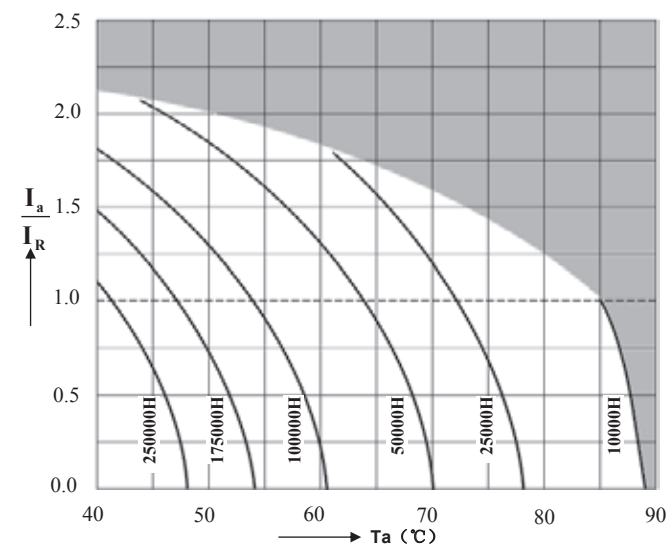

depending on ambient temperature T_a versus under ripple current operating conditions

UJ Series 105°C

Features

Standard capacitors

Applications

- ◆ Professional power supplies
- ◆ Frequency converters
- ◆ Uninterruptible power supplies
- ◆ Used for air conditioner, general-purpose inverter

Features

- ◆ High reliability
- ◆ Long useful life
- ◆ High ripple current capability
- ◆ Aluminum case designed explosion-proof vent
- ◆ RoHS-compatible

Construction

- ◆ Charge-discharge proof, polar
- ◆ Aluminum case with insulating sleeve
- ◆ Aluminum case designed explosion-proof vent
- ◆ Snap-in solder pins to hold component in place on PC-board



Specifications

Item	Performance Characteristics			
Operating Temperature Range	-40 to +105°C		-25 to +105°C	
Rated voltage V_R	200 to 450 V DC		500 to 550 V DC	
Surge voltage V_S	$V_R \leq 315V$ 1.15 V_R $V_R > 315V$ 1.10 V_R			
Rated capacitance C_R	82 ~ 3300 μF		47 ~ 1000 μF	
Capacitance tolerance	$\pm 20\%$ (120Hz, +20°C)			
Leakage Current I_{leak} (+20°C, max.)	$I \leq 3 \sqrt{CV}$ (μA) After 5 minutes with rated working voltage applied			
Dissipation Factor ($\tan \delta$, at 20°C, 120Hz)	Less than the value under table(%)			
	W.V.(V)	160~420	450~550	
	D.F.(%) max	15	20	
Self-inductance ESL	approx. 20 nH			
Useful life 105°C; $V_R, I_{AC, R}$	>5000 h	Requirements:		
		$\Delta C/C$	$\leq \pm 20\%$ of initial value	
		$\tan \delta$	≤ 2 times initial specified limit	
		I_{leak}	\leq initial specified limit	
Voltage Endurance test 105°C; V_R	2000 h	Post test requirements:		
		$\Delta C/C$	$\leq \pm 10\%$ of initial value	
		$\tan \delta$	≤ 1.3 times initial specified limit	
		I_{leak}	\leq initial specified limit	
Shelf Life 105°C	1000 h	Post test requirements:		
		$\Delta C/C$	$\leq \pm 10\%$ of initial value	
		$\tan \delta$	≤ 1.3 times initial specified limit	
		I_{leak}	\leq initial specified limit	
Vibration Resistance test	To IEC 60068-2-6, test Fc:			
	Displacement amplitude 0.75 mm, frequency range 10 ... 55 Hz, acceleration max. 10 g, duration 3x2 h. Capacitor mounted by its body which is rigidly clamped to the work surface.			
Characteristics at low temperature	Max. impedance ratio at 120 Hz			
	$V_R(V)$	200-250 V	315-450 V	$\geq 500 V$
	$Z_{-25^\circ C} / Z_{20^\circ C}$	4	8	8
	$Z_{-40^\circ C} / Z_{20^\circ C}$	7	10	-
Sectional specification	IEC 60384-4 and JIS-C-5101			

Multiplier for Ripple Current vs. Frequency

$V_R(V)/$ Frequency(Hz)	50(60)	120	300	1K	10K	50K-100K
$160 \leq VR \leq 250$	0.81	1	1.17	1.32	1.45	1.5
$315 \leq VR \leq 600$	0.77	1	1.16	1.30	1.41	1.43

Dimensional drawings

1. Standard 2 terminals

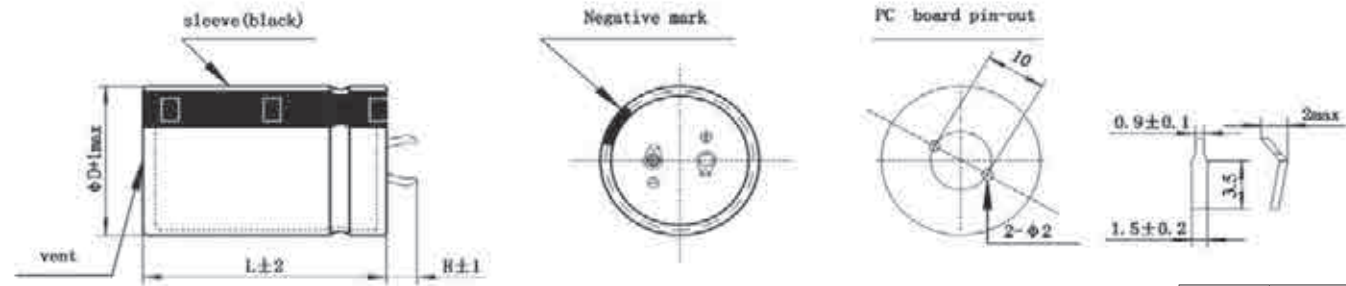

Standard snap-in terminals: length (6.0 ± 1) mm
 Also available with length of (4.0 ± 1) mm

H	h
6	2.5
4	1.5

2. Vibration proof terminal T type

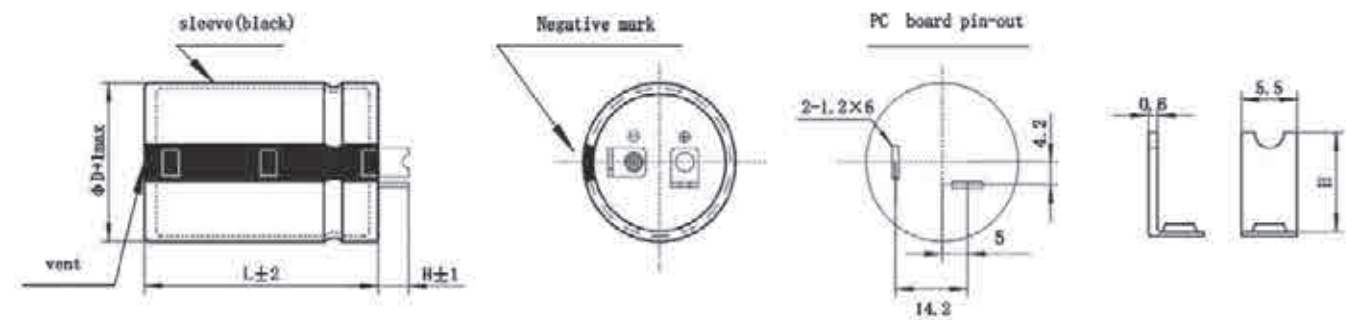

Standard terminals: Length 4.5 ± 1 mm. Also available with length of 5.5 ± 1 mm

Packing

Capacitor diameter D(mm)	Length L(mm)	Terminal length H(mm)	Each carton packing Qty units(pcs.)	Box/carton units(pcs.)	Each box packing Qty units(pcs.)
20	all	/	720	6	120
22	< 55	/	600	6	100
22	≥ 55	/	400	4	100
25	< 65	/	500	5	100
25	≥ 65	/	400	4	100
30	≤ 36	< 6(L=35、36)	400	8	50
30	$35 \leq L \leq 65$	$\geq 6(L=35、36)$	300	6	50
30	> 65	/	200	4	50
35	≤ 25	/	400	8	50
35	$25 < L < 45$	/	300	6	50
35	$45 \leq L \leq 85$	/	200	4	50
35	> 85	/	100	2	50
40	35	< 6	200	5	40
40	35	≥ 6	160	4	40
40	$40 \leq L \leq 45$	/	160	4	40
40	$45 < L \leq 75$	/	120	3	40
40	> 75	/	80	2	40
45	$40 \leq L \leq 65$	/	140	4	35
45	$65 < L \leq 100$	/	70	2	35

Packing of snap-in



Case Size

WV (Vdc)	Cap (uF)	Size (mm)	Rated Ripple current (Arms/105°C /120Hz)	Typ. ESR 20°C 120Hz (mΩ)	MAX ESR 20°C 120Hz (mΩ)
200	330	22x25	1.13	330	600
200	390	22x25	1.21	280	510
200	390	22x30	1.25	280	510
200	390	25x25	1.31	280	510
200	470	22x30	1.40	230	420
200	470	25x25	1.40	230	420
200	470	25x30	1.52	230	420
200	560	22x35	1.61	200	360
200	560	25x30	1.61	200	360
200	560	30x25	1.62	200	360
200	680	22x40	1.86	160	290
200	680	25x30	1.69	160	290
200	680	30x25	1.98	160	290
200	820	22x45	2.14	130	240
200	820	25x35	2.14	130	240
200	820	30x30	2.29	130	240
200	1000	22x50	2.48	110	200
200	1000	25x40	2.48	110	200
200	1000	30x30	2.52	110	200
200	1000	35x25	2.44	110	200
200	1200	25x45	2.89	94	170
200	1200	30x35	2.89	94	170
200	1200	35x30	3.03	94	170
200	1500	25x55	3.52	72	130
200	1500	30x40	3.59	72	130
200	1500	35x35	3.52	72	130
200	1800	30x45	4.09	61	110
200	1800	35x35	3.77	61	110
200	2200	30x55	4.82	50	90
200	2200	35x45	4.82	50	90
200	2700	35x50	5.16	41	74
200	3300	35x55	5.85	33	60
250	220	22x25	0.91	500	900
250	270	22x25	1.03	410	740
250	330	22x30	1.20	330	600
250	390	22x35	1.37	280	510
250	390	25x25	1.26	280	510
250	470	22x35	1.53	230	420
250	470	25x30	1.53	230	420

WV (Vdc)	Cap (uF)	Size (mm)	Rated Ripple current (Arms/105°C /120Hz)	Typ. ESR 20°C 120Hz (mΩ)	MAX ESR 20°C 120Hz (mΩ)
250	470	30x25	1.69	230	420
250	560	22x40	1.76	200	360
250	560	25x35	1.68	200	360
250	680	22x45	2.04	160	290
250	680	25x40	2.13	160	290
250	680	30x30	2.13	160	290
250	680	35x25	2.12	160	290
250	820	25x45	2.23	130	240
250	820	30x35	2.45	130	240
250	820	35x30	2.62	130	240
250	1000	25x50	2.57	110	200
250	1000	30x40	2.85	110	200
250	1000	35x30	2.77	110	200
250	1200	30x45	3.42	94	170
250	1200	35x35	3.26	94	170
250	1500	30x50	3.72	72	130
250	1500	35x40	3.78	72	130
250	1800	35x45	4.09	61	110
250	2200	35x55	5.04	50	90
350	100	22x25	0.59	1110	1990
350	120	22x30	0.69	920	1660
350	120	25x25	0.69	920	1660
350	150	22x35	0.80	740	1330
350	180	25x30	0.85	620	1110
350	180	30x25	0.89	620	1110
350	220	22x40	0.99	500	900
350	220	25x40	1.10	500	900
350	220	30x30	1.08	500	900
350	220	35x25	1.08	500	900
350	270	25x45	1.28	410	740
350	270	30x35	1.25	410	740
350	270	35x25	1.25	410	740
350	330	25x50	1.55	330	600
350	330	30x35	1.46	330	600
350	330	35x30	1.46	330	600
350	390	35x40	1.92	280	510
350	470	35x45	2.17	230	420
350	560	35x45	2.41	200	360
350	560	40x40	2.46	200	360

WV (Vdc)	Cap (uF)	Size (mm)	Rated Ripple current (Arms/105°C /120Hz)	Typ. ESR 20°C 120Hz (mΩ)	MAX ESR 20°C 120Hz (mΩ)
350	680	35x55	2.79	160	290
350	680	40x45	2.79	160	290
350	820	35x60	3.21	130	240
350	820	40x50	3.15	130	240
350	820	45x40	3.11	130	240
350	1000	35x60	3.23	110	200
350	1000	40x50	3.26	110	200
350	1200	40x55	3.68	94	170
350	1500	40x65	4.56	72	130
350	1800	40x75	5.67	61	110
400	100	22x25	0.65	1110	1990
400	120	22x25	0.92	920	1660
400	150	22x30	1.08	740	1330
400	180	22x30	1.15	620	1110
400	180	25x25	1.12	620	1110
400	220	22x35	1.32	500	900
400	220	25x30	1.30	500	900
400	270	22x40	1.50	410	740
400	270	25x35	1.49	410	740
400	270	30x25	1.33	410	740
400	330	22x50	1.76	330	600
400	330	25x40	1.68	330	600
400	330	30x30	1.55	330	600
400	330	35x25	1.44	330	600
400	390	22x55	1.94	280	510
400	390	25x45	1.86	280	510
400	390	30x35	1.75	280	510
400	390	35x30	1.75	280	510
400	470	25x50	2.07	230	420
400	470	30x40	1.97	230	420
400	470	35x30	1.91	230	420
400	560	25x60	2.37	200	360
400	560	30x45	2.18	200	360
400	560	35x35	1.92	200	360
400	680	30x50	2.41	160	290
400	680	35x40	2.35	160	290
400	820	30x60	2.76	130	240
400	820	35x45	2.67	130	240
400	1000	35x55	3.16	110	200
400	1000	40x50	3.24	110	200
400	1200	35x60	3.56	94	170
400	1200	40x55	3.64	94	170
400	1500	45x70	4.68	72	130
400	1800	45x80	5.29	61	110
450	82	22x25	0.59	1790	3230
450	100	22x30	0.69	1470	2650
450	100	25x25	0.69	1470	2650
450	120	22x35	0.72	1230	2210
450	150	22x35	0.92	980	1770
450	150	25x30	0.91	980	1770
450	150	30x25	0.97	980	1770
450	180	22x40	1.28	820	1470
450	180	25x30	1.20	820	1470
450	180	30x25	1.18	820	1470
450	220	22x45	1.44	670	1210
450	220	25x35	1.37	670	1210
450	220	30x30	1.36	670	1210
450	330	22x60	1.86	440	800
450	330	25x50	1.82	440	800
450	330	30x35	1.64	440	800

WV (Vdc)	Cap (uF)	Size (mm)	Rated Ripple current (Arms/105°C /120Hz)	Typ. ESR 20°C 120Hz (mΩ)	MAX ESR 20°C 120Hz (mΩ)
450	330	35x30	1.64	440	800
450	390	25x55	2.01	380	680
450	390	30x40	1.83	380	680
450	390	35x35	1.83	380	680
450	470	25x60	2.21	310	560
450	470	30x45	2.05	310	560
450	470	35x40	2.05	310	560
450	560	30x50	2.26	260	470
450	560	35x45	2.18	260	470
450	680	30x60	2.59	220	390
450	680	35x50	2.58	220	390
450	820	35x60	2.80	180	320
450	820	40x50	2.80	180	320
450	1000	35x65	3.21	150	270
450	1000	40x55	3.21	150	270
450	1200	40x70	3.54	120	220
500	56	22x25	0.63	2630	4740
500	82	22x35	0.82	1790	3230
500	82	25x25	0.78	1790	3230
500	120	22x45	1.05	1230	2210
500	120	25x35	1.02	1230	2210
500	120	30x25	0.97	1230	2210
500	150	22x50	1.20	980	1770
500	150	25x40	1.17	980	1770
500	150	30x30	1.13	980	1770
500	150	35x25	1.09	980	1770
500	180	22x60	1.37	820	1470
500	180	25x45	1.31	820	1470
500	180	30x35	1.28	820	1470
500	180	35x30	1.26	820	1470
500	220	25x50	1.46	670	1210
500	220	30x40	1.45	670	1210
500	220	35x35	1.44	670	1210
500	270	25x60	1.70	540	980
500	270	30x45	1.63	540	980
500	270	35x35	1.63	540	980
500	330	30x50	1.81	440	800
500	330	35x40	1.71	440	800
500	390	30x60	2.06	380	680
500	390	35x50	2.06	380	680
500	470	35x55	2.19	310	560
500	560	35x60	2.65	260	470
500	680	40x60	3.00	220	390
500	820	40x70	4.00	180	320
500	1000	40x80	4.68	150	270
550	47	25x25	0.47	3130	5640
550	56	25x30	0.54	2630	4740
550	68	25x35	0.62	2170	3900
550	68	30x25	0.65	2170	3900
550	82	25x35	0.69	1790	3230
550	82	30x30	0.73	1790	3230
550	100	25x40	0.80	1470	2650
550	100	30x35	0.84	1470	2650
550	100	35x25	0.87	1470	2650
550	120	25x50	0.92	1230	2210
550	120	30x35	0.94	1230	2210
550	120	35x30	1.04	1230	2210
550	150	25x55	1.09	980	1770
550	150	30x45	1.17	980	1770
550	150	35x35	1.21	980	1770

WV (Vdc)	Cap (uF)	Size (mm)	Rated Ripple current (Arms/105°C /120Hz)	Typ. ESR 20°C 120Hz (mΩ)	MAX ESR 20°C 120Hz (mΩ)
550	180	30x50	1.33	820	1470
550	180	35x35	1.29	820	1470
550	180	35x40	1.36	820	1470
550	220	30x55	1.54	670	1210
550	220	35x35	1.40	670	1210
550	220	35x45	1.56	670	1210

WV (Vdc)	Cap (uF)	Size (mm)	Rated Ripple current (Arms/105°C /120Hz)	Typ. ESR 20°C 120Hz (mΩ)	MAX ESR 20°C 120Hz (mΩ)
550	270	35x40	1.63	540	980
550	270	35x50	1.79	540	980
550	330	35x50	1.66	440	800
550	390	35x55	1.85	380	680
550	470	35x60	2.10	310	560

Useful life

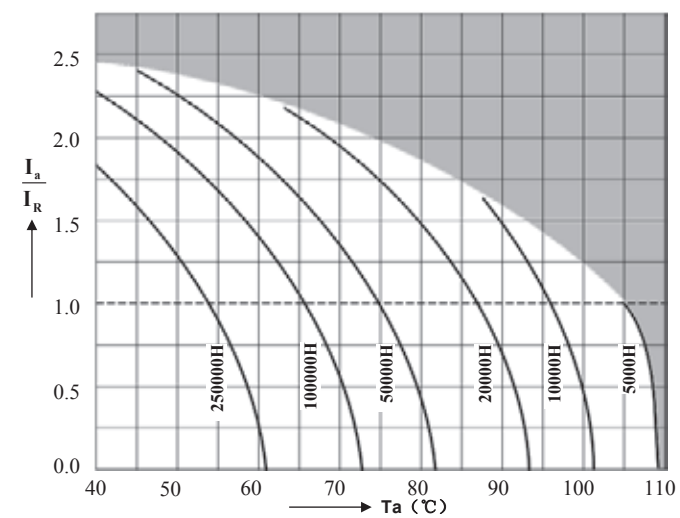

depending on ambient temperature T_a versus under ripple current operating conditions

UK Series 105°C

Features

Standard capacitors

Applications

- ◆ Professional power supplies
- ◆ Frequency converters
- ◆ Uninterruptible power supplies
- ◆ Used for air conditioner, general-purpose inverter

Features

- ◆ High reliability
- ◆ Long useful life
- ◆ High ripple current capability
- ◆ Aluminum case designed explosion-proof vent
- ◆ RoHS-compatible

Construction

- ◆ Charge-discharge proof, polar
- ◆ Aluminum case with insulating sleeve
- ◆ Aluminum case designed explosion-proof vent
- ◆ Snap-in solder pins to hold component in place on PC-board



Specifications

Item	Performance Characteristics			
Operating Temperature Range	-40 to +105°C		-25 to +105°C	
Rated voltage V_R	200 to 450 V DC		500 to 550 V DC	
Surge voltage V_S	$V_R \leq 315V$ 1.15 V_R $V_R > 315V$ 1.10 V_R			
Rated capacitance C_R	68 ~ 2200 μF		47 ~ 680 μF	
Capacitance tolerance	$\pm 20\%$ (120Hz, +20°C)			
Leakage Current I_{leak} (+20°C, max.)	$I \leq 3 \sqrt{CV}$ (μA) After 5 minutes with rated working voltage applied			
Dissipation Factor ($\tan \delta$, at 20°C, 120Hz)	Less than the value under table(%)			
	W.V.(V)	160~420	450~550	
	D.F.(%) max	15	20	
Self-inductance ESL	approx. 20 nH			
Useful life 105°C; $V_R, I_{AC, R}$	>8000 h	Requirements:		
		$\Delta C/C$	$\leq \pm 20\%$ of initial value	
	$\tan \delta$	≤ 2 times initial specified limit		
	I_{leak}	\leq initial specified limit		
Voltage Endurance test 105°C; V_R	3000 h	Post test requirements:		
		$\Delta C/C$	$\leq \pm 10\%$ of initial value	
	$\tan \delta$	≤ 1.3 times initial specified limit		
	I_{leak}	\leq initial specified limit		
Shelf Life 105°C	1000 h	Post test requirements:		
		$\Delta C/C$	$\leq \pm 10\%$ of initial value	
	$\tan \delta$	≤ 1.3 times initial specified limit		
	I_{leak}	\leq initial specified limit		
Vibration Resistance test	To IEC 60068-2-6, test Fc:			
	Displacement amplitude 0.75 mm, frequency range 10 ... 55 Hz, acceleration max. 10 g, duration 3x2 h. Capacitor mounted by its body which is rigidly clamped to the work surface.			
Characteristics at low temperature	Max. impedance ratio at 120 Hz			
	$V_R(V)$	200-250 V	315-450 V	$\geq 500 V$
	$Z_{-25^\circ C} / Z_{20^\circ C}$	4	8	8
	$Z_{-40^\circ C} / Z_{20^\circ C}$	7	10	-
Sectional specification	IEC 60384-4 and JIS-C-5101			

For inverter

Multiplier for Ripple Current vs. Frequency

$V_R(V)/$ Frequency(Hz)	50(60)	120	300	1K	10K	50K-100K
$160 \leq VR \leq 250$	0.81	1	1.17	1.32	1.45	1.5
$315 \leq VR \leq 600$	0.77	1	1.16	1.30	1.41	1.43

Dimensional drawings

1. Standard 2 terminals

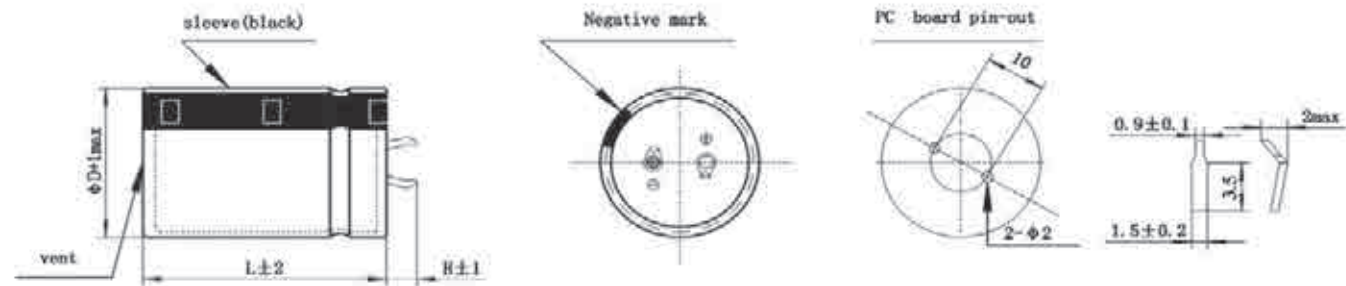

Standard snap-in terminals: length (6.0 ± 1) mm
 Also available with length of (4.0 ± 1) mm

H	h
6	2.5
4	1.5

2. Vibration proof terminal T type

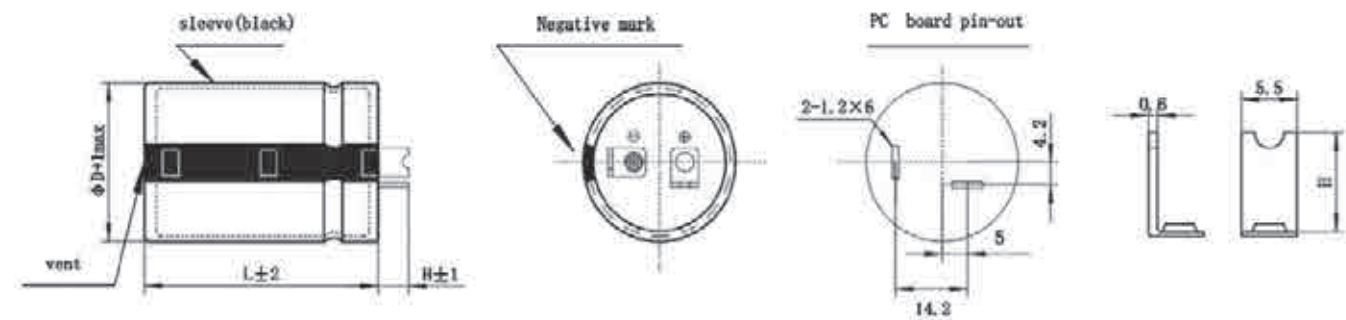

Standard terminals: Length 4.5 ± 1 mm. Also available with length of 5.5 ± 1 mm

Packing

Capacitor diameter D(mm)	Length L(mm)	Terminal length H(mm)	Each carton packing Qty units(pcs.)	Box/carton units(pcs.)	Each box packing Qty units(pcs.)
20	all	/	720	6	120
22	< 55	/	600	6	100
22	≥ 55	/	400	4	100
25	< 65	/	500	5	100
25	≥ 65	/	400	4	100
30	≤ 36	< 6(L=35、36)	400	8	50
30	$35 \leq L \leq 65$	$\geq 6(L=35、36)$	300	6	50
30	> 65	/	200	4	50
35	≤ 25	/	400	8	50
35	$25 < L < 45$	/	300	6	50
35	$45 \leq L \leq 85$	/	200	4	50
35	> 85	/	100	2	50
40	35	< 6	200	5	40
40	35	≥ 6	160	4	40
40	$40 \leq L \leq 45$	/	160	4	40
40	$45 < L \leq 75$	/	120	3	40
40	> 75	/	80	2	40
45	$40 \leq L \leq 65$	/	140	4	35
45	$65 < L \leq 100$	/	70	2	35

Packing of snap-in



Case Size

WV (Vdc)	Cap (uF)	Size (mm)	Rated Ripple current (Arms/105°C /120Hz)	Typ. ESR 20°C 120Hz (mΩ)	MAX ESR 20°C 120Hz (mΩ)
200	330	22x25	1.38	320	600
200	390	22x25	1.45	280	510
200	470	22x30	1.68	230	420
200	470	25x25	1.68	230	420
200	560	22x35	1.81	190	360
200	560	25x30	1.78	190	360
200	560	30x25	1.96	190	360
200	680	22x40	2.15	160	290
200	680	25x35	2.06	160	290
200	680	30x25	2.17	160	290
200	820	22x45	2.42	130	240
200	820	25x35	2.22	130	240
200	820	30x25	2.34	130	240
200	1000	25x45	2.72	110	200
200	1000	30x30	2.91	110	200
200	1000	35x25	3.14	110	200
200	1200	25x50	2.87	92	170
200	1200	30x35	3.42	92	170
200	1200	35x30	3.38	92	170
200	1500	25x60	3.29	70	130
200	1500	30x45	4.12	70	130
200	1500	35x35	3.91	70	130
200	1800	30x50	4.33	59	110
200	1800	35x40	4.46	59	110
200	2200	30x60	4.75	49	90
200	2200	35x45	5.11	49	90
250	220	22x25	1.15	490	900
250	270	22x25	1.21	400	740
250	330	22x30	1.52	320	600
250	330	25x25	1.45	320	600
250	390	22x35	1.72	280	510
250	390	22x40	1.82	280	510
250	390	25x30	1.58	280	510
250	390	30x25	1.62	280	510
250	470	22x40	1.96	230	420
250	470	25x30	1.72	230	420
250	470	30x25	1.88	230	420
250	560	22x45	2.16	190	360
250	560	25x35	1.96	190	360
250	560	30x30	2.22	190	360

WV (Vdc)	Cap (uF)	Size (mm)	Rated Ripple current (Arms/105°C /120Hz)	Typ. ESR 20°C 120Hz (mΩ)	MAX ESR 20°C 120Hz (mΩ)
250	560	35x25	2.08	190	360
250	680	22x50	2.41	160	290
250	680	25x40	2.21	160	290
250	680	30x30	2.35	160	290
250	680	35x25	2.50	160	290
250	820	30x35	2.78	130	240
250	820	35x30	2.90	130	240
250	1000	30x40	3.30	110	200
250	1000	35x35	3.36	110	200
250	1200	30x50	3.85	92	170
250	1200	35x40	3.82	92	170
250	1500	30x55	4.33	70	130
250	1500	35x45	4.34	70	130
250	1800	35x50	4.70	59	110
250	2200	35x60	5.58	49	90
315	150	22x25	1.00	720	1330
315	180	22x30	1.15	600	1110
315	220	22x30	1.30	490	900
315	220	25x25	1.30	490	900
315	270	22x35	1.41	400	740
315	270	25x30	1.42	400	740
315	330	22x40	1.74	320	600
315	330	25x35	1.58	320	600
315	330	30x25	1.62	320	600
315	390	22x50	1.94	280	510
315	390	25x35	1.70	280	510
315	390	30x30	1.78	280	510
315	390	35x25	1.80	280	510
315	470	22x55	2.05	230	420
315	470	25x45	2.04	230	420
315	470	30x35	2.03	230	420
315	470	35x30	2.07	230	420
315	560	25x50	2.28	190	360
315	560	30x35	2.23	190	360
315	560	35x30	2.25	190	360
315	680	25x55	2.70	160	290
315	680	30x40	2.66	160	290
315	680	35x35	2.70	160	290
315	820	30x50	3.12	130	240
315	820	35x40	3.10	130	240

WV (Vdc)	Cap (uF)	Size (mm)	Rated Ripple current (Arms/105°C /120Hz)	Typ. ESR 20°C 120Hz (mΩ)	MAX ESR 20°C 120Hz (mΩ)
315	1000	30x55	3.64	110	200
315	1000	35x45	3.56	110	200
315	1200	35x50	4.05	92	170
315	1500	35x60	4.35	70	130
350	100	22x25	0.74	1080	1990
350	100	25x20	0.52	1080	1990
350	120	22x25	0.92	900	1660
350	150	22x30	1.06	720	1330
350	180	22x30	1.17	600	1110
350	180	25x25	1.17	600	1110
350	220	22x35	1.32	490	900
350	220	22x40	1.40	490	900
350	220	25x30	1.33	490	900
350	220	30x25	1.35	490	900
350	270	22x45	1.55	400	740
350	270	25x35	1.47	400	740
350	270	30x25	1.37	400	740
350	330	22x50	1.76	320	600
350	330	25x40	1.68	320	600
350	330	30x30	1.64	320	600
350	330	35x25	1.69	320	600
350	390	25x45	1.86	280	510
350	390	30x35	1.84	280	510
350	390	35x30	1.87	280	510
350	470	25x50	2.09	230	420
350	470	30x40	2.09	230	420
350	470	35x30	2.08	230	420
350	560	30x45	2.24	190	360
350	560	35x35	2.26	190	360
350	680	30x50	2.67	160	290
350	680	35x40	2.71	160	290
350	820	35x45	3.11	130	240
350	820	35x50	3.25	130	240
350	1000	35x55	3.58	110	200
350	1200	35x60	4.10	92	170
400	82	22x25	0.61	1310	2430
400	100	22x25	0.67	1080	1990
400	120	22x30	0.79	900	1660
400	120	25x25	0.79	900	1660
400	120	25x30	0.85	900	1660
400	150	22x35	0.95	720	1330
400	150	22x40	1.00	720	1330
400	150	25x25	0.89	720	1330
400	150	25x30	0.96	720	1330
400	150	30x25	0.99	720	1330
400	180	22x35	1.04	600	1110
400	180	22x40	1.10	600	1110
400	180	25x30	1.05	600	1110
400	180	25x35	1.12	600	1110
400	180	30x25	1.09	600	1110
400	180	30x30	1.17	600	1110
400	220	22x45	1.20	490	900
400	220	25x35	1.20	490	900
400	220	25x45	1.24	490	900
400	220	30x25	1.15	490	900
400	220	30x30	1.24	490	900
400	220	35x25	1.24	490	900
400	270	22x50	1.32	400	740
400	270	25x40	1.29	400	740
400	270	25x50	1.42	400	740
400	270	30x30	1.27	400	740
400	270	30x35	1.35	400	740

WV (Vdc)	Cap (uF)	Size (mm)	Rated Ripple current (Arms/105°C /120Hz)	Typ. ESR 20°C 120Hz (mΩ)	MAX ESR 20°C 120Hz (mΩ)
400	270	35x25	1.30	400	740
400	270	35x30	1.39	400	740
400	330	25x45	1.50	320	600
400	330	25x50	1.57	320	600
400	330	30x35	1.50	320	600
400	330	30x40	1.58	320	600
400	330	35x30	1.54	320	600
400	330	35x35	1.64	320	600
400	390	25x50	1.70	280	510
400	390	30x40	1.72	280	510
400	390	30x45	1.80	280	510
400	390	35x30	1.70	280	510
400	390	35x35	1.78	280	510
400	470	30x45	1.98	230	420
400	470	30x50	2.07	230	420
400	470	35x35	1.98	230	420
400	470	35x40	2.07	230	420
400	470	35x45	2.16	230	420
400	560	30x50	2.26	190	360
400	560	35x40	2.26	190	360
400	560	35x45	2.36	190	360
400	680	30x50	2.49	160	290
400	680	35x45	2.60	160	290
400	680	35x50	2.72	160	290
400	820	35x55	3.11	130	240
400	820	35x60	3.23	130	240
400	1000	35x55	3.44	110	200
400	1000	35x60	3.57	110	200
400	1200	35x60	3.91	92	170
450	68	22x25	0.55	2110	3900
450	82	22x25	0.61	1750	3230
450	100	22x30	0.72	1430	2650
450	100	25x25	0.72	1430	2650
450	120	22x35	0.85	1190	2210
450	120	22x40	0.90	1190	2210
450	120	25x30	0.85	1190	2210
450	120	25x35	0.91	1190	2210
450	120	30x25	0.85	1190	2210
450	150	22x40	1.00	960	1770
450	150	25x30	0.96	960	1770
450	150	25x35	1.02	960	1770
450	150	30x25	1.00	960	1770
450	150	30x30	1.06	960	1770
450	150	35x25	1.09	960	1770
450	180	22x45	1.16	790	1470
450	180	22x50	1.21	790	1470
450	180	25x35	1.12	790	1470
450	180	25x40	1.21	790	1470
450	180	30x30	1.21	790	1470
450	180	30x35	1.24	790	1470
450	180	35x25	1.21	790	1470
450	180	35x30	1.28	790	1470
450	220	25x40	1.24	650	1210
450	220	25x45	1.28	650	1210
450	220	30x30	1.24	650	1210
450	220	30x35	1.28	650	1210
450	220	35x25	1.24	650	1210
450	220	35x30	1.28	650	1210
450	270	25x50	1.42	530	980
450	270	30x30	1.28	530	980
450	270	30x35	1.35	530	980
450	270	35x30	1.39	530	980

WV (Vdc)	Cap (uF)	Size (mm)	Rated Ripple current (Arms/105°C /120Hz)	Typ. ESR 20°C 120Hz (mΩ)	MAX ESR 20°C 120Hz (mΩ)
450	270	35x35	1.48	530	980
450	330	30x40	1.58	430	800
450	330	30x45	1.66	430	800
450	330	35x30	1.58	430	800
450	330	35x35	1.66	430	800
450	390	30x45	1.80	370	680
450	390	30x50	1.89	370	680
450	390	35x40	1.89	370	680
450	390	35x45	1.97	370	680
450	470	30x50	2.08	300	560
450	470	35x35	1.97	300	560
450	470	35x40	2.08	300	560
450	470	35x45	2.16	300	560
450	560	35x50	2.47	250	470
450	560	35x55	2.57	250	470
450	680	35x50	2.72	210	390
450	680	35x60	2.94	210	390
450	820	35x60	3.23	170	320
450	820	35x65	3.35	170	320
500	47	22x25	0.45	3050	5640
500	56	22x30	0.52	2560	4740
500	68	22x30	0.52	2110	3900
500	68	22x35	0.56	2110	3900
500	68	25x25	0.54	2110	3900
500	68	25x30	0.58	2110	3900
500	82	22x35	0.70	1750	3230
500	82	25x30	0.71	1750	3230
500	100	22x40	0.81	1430	2650
500	100	25x35	0.86	1430	2650

WV (Vdc)	Cap (uF)	Size (mm)	Rated Ripple current (Arms/105°C /120Hz)	Typ. ESR 20°C 120Hz (mΩ)	MAX ESR 20°C 120Hz (mΩ)
500	100	30x30	0.85	1430	2650
500	120	22x50	0.98	1190	2210
500	120	25x40	0.95	1190	2210
500	120	30x35	1.00	1190	2210
500	120	35x30	1.03	1190	2210
500	150	22x50	1.10	960	1770
500	150	25x45	1.13	960	1770
500	150	30x40	1.19	960	1770
500	150	35x35	1.23	960	1770
500	180	25x50	1.24	790	1470
500	180	30x45	1.31	790	1470
500	220	25x55	1.45	650	1210
500	220	30x45	1.47	650	1210
500	220	35x35	1.45	650	1210
500	220	35x40	1.53	650	1210
500	270	30x50	1.55	530	980
500	270	35x40	1.62	530	980
500	330	30x55	1.89	430	800
500	390	35x45	1.85	370	680
500	390	35x55	2.02	370	680
500	470	35x60	2.28	300	560
500	560	35x65	2.32	250	470
500	680	40x60	2.45	210	390
550	220	35x35	1.30	650	1210
550	270	35x45	1.60	530	980
550	330	35x50	1.63	430	800
550	390	35x55	1.80	370	680
550	470	35x65	2.10	300	560

Useful life

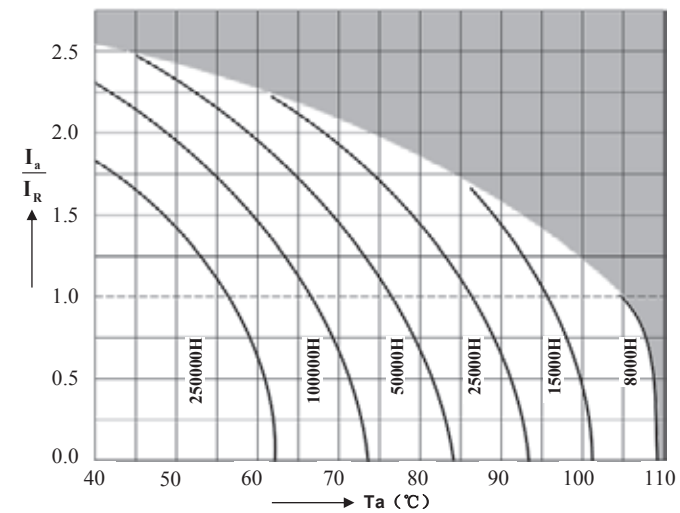

depending on ambient temperature T_a versus under ripple current operating conditions

UL Series 105°C

Features

Standard capacitors

Applications

- ◆ Professional power supplies
- ◆ Frequency converters
- ◆ Uninterruptible power supplies
- ◆ Used for air conditioner, general-purpose inverter

Features

- ◆ High reliability
- ◆ Long useful life
- ◆ High ripple current capability
- ◆ Aluminum case designed explosion-proof vent
- ◆ RoHS-compatible

Construction

- ◆ Charge-discharge proof, polar
- ◆ Aluminum case with insulating sleeve
- ◆ Aluminum case designed explosion-proof vent
- ◆ Snap-in solder pins to hold component in place on PC-board



Specifications

Item	Performance Characteristics			
Operating Temperature Range	-40 to +105°C		-25 to +105°C	
Rated voltage V_R	200 to 450 V DC		500 to 550 V DC	
Surge voltage V_S	$V_R \leq 315V$ 1.15 V_R $V_R > 315V$ 1.10 V_R			
Rated capacitance C_R	68 ~ 3300 μF		100 ~ 1500 μF	
Capacitance tolerance	$\pm 20\%$ (120Hz, +20°C)			
Leakage Current I_{leak} (+20°C, max.)	$I \leq 3 \sqrt{CV}$ (μA) After 5 minutes with rated working voltage applied			
Dissipation Factor ($\tan \delta$, at 20°C, 120Hz)	Less than the value under table(%)			
	W.V.(V)	160~420	450~550	
	D.F.(%) max	15	20	
Self-inductance ESL	approx. 20 nH			
Useful life 105°C; $V_R, I_{AC, R}$	>10000 h	Requirements:		
		$\Delta C/C$	$\leq \pm 20\%$ of initial value	
	$\tan \delta$	≤ 2 times initial specified limit		
	I_{leak}	\leq initial specified limit		
Voltage Endurance test 105°C; V_R	5000 h	Post test requirements:		
		$\Delta C/C$	$\leq \pm 10\%$ of initial value	
	$\tan \delta$	≤ 1.3 times initial specified limit		
	I_{leak}	\leq initial specified limit		
Shelf Life 105°C	1000 h	Post test requirements:		
		$\Delta C/C$	$\leq \pm 10\%$ of initial value	
	$\tan \delta$	≤ 1.3 times initial specified limit		
	I_{leak}	\leq initial specified limit		
Vibration Resistance test	To IEC 60068-2-6, test Fc:			
	Displacement amplitude 0.75 mm, frequency range 10 ... 55 Hz, acceleration max. 10 g, duration 3x2 h. Capacitor mounted by its body which is rigidly clamped to the work surface.			
Characteristics at low temperature	Max. impedance ratio at 120 Hz			
	$V_R(V)$	200-250 V	315-450 V	$\geq 500 V$
	$Z_{-25^\circ C} / Z_{20^\circ C}$	3	8	8
	$Z_{-40^\circ C} / Z_{20^\circ C}$	7	10	-
Sectional specification	IEC 60384-4 and JIS-C-5101			

Multiplier for Ripple Current vs. Frequency

$V_R(V)/$ Frequency(Hz)	50(60)	120	300	1K	10K	50K-100K
$160 \leq V_R \leq 250$	0.81	1	1.17	1.32	1.45	1.5
$315 \leq V_R \leq 600$	0.77	1	1.16	1.30	1.41	1.43

Dimensional drawings

1. Standard 2 terminals

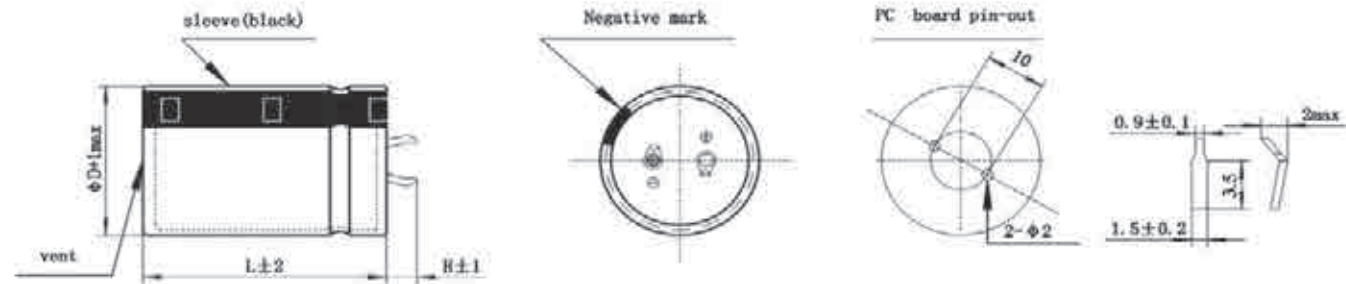

Standard snap-in terminals: length (6.0 ± 1) mm
 Also available with length of (4.0 ± 1) mm

H	h
6	2.5
4	1.5

2. Vibration proof terminal T type

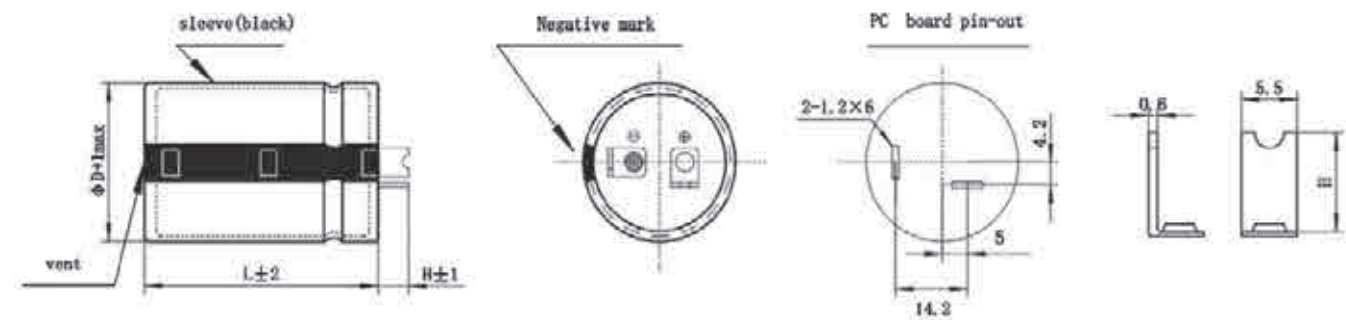

Standard terminals: Length 4.5 ± 1 mm. Also available with length of 5.5 ± 1 mm

Packing

Capacitor diameter D(mm)	Length L(mm)	Terminal length H(mm)	Each carton packing Qty units(pcs.)	Box/carton units(pcs.)	Each box packing Qty units(pcs.)
20	all	/	720	6	120
22	< 55	/	600	6	100
22	≥ 55	/	400	4	100
25	< 65	/	500	5	100
25	≥ 65	/	400	4	100
30	≤ 36	< 6(L=35、36)	400	8	50
30	$35 \leq L \leq 65$	$\geq 6(L=35、36)$	300	6	50
30	> 65	/	200	4	50
35	≤ 25	/	400	8	50
35	$25 < L < 45$	/	300	6	50
35	$45 \leq L \leq 85$	/	200	4	50
35	> 85	/	100	2	50
40	35	< 6	200	5	40
40	35	≥ 6	160	4	40
40	$40 \leq L \leq 45$	/	160	4	40
40	$45 < L \leq 75$	/	120	3	40
40	> 75	/	80	2	40
45	$40 \leq L \leq 65$	/	140	4	35
45	$65 < L \leq 100$	/	70	2	35

Packing of snap-in



Case Size

WV (Vdc)	Cap (uF)	Size (mm)	Rated Ripple current (Arms/105°C /120Hz)	Typ. ESR 20°C 120Hz (mΩ)	MAX ESR 20°C 120Hz (mΩ)
200	180	22x20	0.75	580	1110
200	220	22x25	0.80	470	900
200	270	22x25	1.31	390	740
200	270	22x30	1.35	390	740
200	270	25x25	1.35	390	740
200	330	22x25	1.41	320	600
200	330	22x30	1.53	320	600
200	330	25x25	1.48	320	600
200	390	22x30	1.63	270	510
200	390	22x35	1.68	270	510
200	390	25x25	1.63	270	510
200	390	25x30	1.68	270	510
200	390	30x25	1.68	270	510
200	470	22x30	1.72	220	420
200	470	22x35	1.84	220	420
200	470	25x25	1.63	220	420
200	470	25x30	1.75	220	420
200	470	35x25	1.75	220	420
200	560	22x35	1.95	190	360
200	560	22x40	2.07	190	360
200	560	25x30	1.84	190	360
200	560	25x35	1.92	190	360
200	560	30x30	1.84	190	360
200	560	35x25	1.84	190	360
200	680	22x40	2.22	150	290
200	680	22x45	2.32	150	290
200	680	25x35	2.11	150	290
200	680	25x40	2.32	150	290
200	680	30x30	2.11	150	290
200	680	30x35	2.32	150	290
200	680	35x30	2.32	150	290
200	820	22x50	2.60	130	240
200	820	25x40	2.37	130	240
200	820	30x30	2.11	130	240
200	820	30x35	2.37	130	240
200	820	35x30	2.37	130	240
200	1000	22x60	3.00	110	200
200	1000	25x45	2.63	110	200
200	1000	30x35	2.37	110	200
200	1000	30x40	2.42	110	200
200	1000	35x30	2.37	110	200

WV (Vdc)	Cap (uF)	Size (mm)	Rated Ripple current (Arms/105°C /120Hz)	Typ. ESR 20°C 120Hz (mΩ)	MAX ESR 20°C 120Hz (mΩ)
200	1000	35x35	2.42	110	200
200	1200	25x50	2.88	89	170
200	1200	30x40	2.55	89	170
200	1200	35x30	2.44	89	170
200	1200	35x35	2.88	89	170
200	1500	30x45	2.82	68	130
200	1500	30x50	3.00	68	130
200	1500	35x35	2.98	68	130
200	1500	35x40	3.08	68	130
200	1800	30x50	3.08	58	110
200	1800	35x40	3.18	58	110
200	1800	35x45	3.28	58	110
200	2200	35x50	3.45	48	90
200	2700	35x60	4.00	39	74
250	220	22x25	0.85	470	900
250	270	22x25	1.32	390	740
250	270	22x30	1.36	390	740
250	270	25x25	1.36	390	740
250	330	22x30	1.55	320	600
250	330	22x35	1.60	320	600
250	330	25x25	1.45	320	600
250	330	25x30	1.60	320	600
250	390	22x35	1.75	270	510
250	390	22x40	1.80	270	510
250	390	25x30	1.68	270	510
250	390	25x35	1.73	270	510
250	390	30x30	1.73	270	510
250	470	22x40	1.97	220	420
250	470	22x45	2.02	220	420
250	470	25x30	1.75	220	420
250	470	25x35	1.80	220	420
250	470	30x25	1.75	220	420
250	470	30x30	1.80	220	420
250	560	22x45	2.20	190	360
250	560	25x40	2.20	190	360
250	560	30x30	1.97	190	360
250	560	30x35	2.05	190	360
250	560	35x30	2.05	190	360
250	680	22x50	2.45	150	290
250	680	25x45	2.25	150	290
250	680	30x35	2.18	150	290

WV (Vdc)	Cap (uF)	Size (mm)	Rated Ripple current (Arms/105°C /120Hz)	Typ. ESR 20°C 120Hz (mΩ)	MAX ESR 20°C 120Hz (mΩ)
250	680	30x40	2.25	150	290
250	680	35x30	2.18	150	290
250	820	25x50	2.49	130	240
250	820	30x45	2.19	130	240
250	820	35x35	2.15	130	240
250	1000	25x55	2.91	110	200
250	1000	30x40	2.44	110	200
250	1000	30x45	2.54	110	200
250	1000	35x35	2.38	110	200
250	1000	35x40	2.54	110	200
250	1200	30x45	2.68	89	170
250	1200	30x50	2.73	89	170
250	1200	35x40	2.72	89	170
250	1500	30x55	3.15	68	130
250	1500	35x45	3.15	68	130
250	1500	35x50	3.20	68	130
250	1800	35x50	3.42	58	110
250	1800	35x55	3.60	58	110
250	2200	35x60	3.75	48	90
315	120	22x25	0.72	870	1660
315	150	22x25	1.00	700	1330
315	150	22x30	1.03	700	1330
315	150	30x25	1.00	700	1330
315	180	22x30	1.14	580	1110
315	180	22x35	1.18	580	1110
315	180	25x30	1.18	580	1110
315	220	22x35	1.31	470	900
315	220	22x40	1.35	470	900
315	220	25x30	1.31	470	900
315	220	25x35	1.35	470	900
315	220	30x25	1.31	470	900
315	270	22x40	1.49	390	740
315	270	22x45	1.54	390	740
315	270	25x35	1.39	390	740
315	270	25x40	1.54	390	740
315	270	30x30	1.39	390	740
315	330	22x45	1.69	320	600
315	330	22x50	1.76	320	600
315	330	25x35	1.59	320	600
315	330	25x40	1.63	320	600
315	330	30x25	1.41	320	600
315	330	30x30	1.46	320	600
315	330	35x25	1.46	320	600
315	390	22x50	1.87	270	510
315	390	25x40	1.78	270	510
315	390	25x45	1.83	270	510
315	390	30x30	1.63	270	510
315	390	30x35	1.68	270	510
315	390	35x25	1.48	270	510
315	390	35x30	1.55	270	510
315	470	22x55	2.09	220	420
315	470	25x45	1.99	220	420
315	470	30x35	1.86	220	420
315	470	30x40	1.99	220	420
315	470	35x30	1.74	220	420
315	470	35x35	1.99	220	420
315	560	22x60	2.29	190	360
315	560	25x50	2.21	190	360
315	560	30x40	2.08	190	360
315	560	30x45	2.16	190	360
315	560	35x30	2.08	190	360
315	560	35x35	2.16	190	360
315	680	25x55	2.44	150	290

WV (Vdc)	Cap (uF)	Size (mm)	Rated Ripple current (Arms/105°C /120Hz)	Typ. ESR 20°C 120Hz (mΩ)	MAX ESR 20°C 120Hz (mΩ)
315	680	25x60	2.50	150	290
315	680	30x45	2.32	150	290
315	680	30x50	2.40	150	290
315	680	35x35	2.16	150	290
315	680	35x40	2.13	150	290
315	820	30x50	2.55	130	240
315	820	30x55	2.59	130	240
315	820	35x40	2.26	130	240
315	820	35x45	2.35	130	240
315	1000	30x55	2.78	110	200
315	1000	30x60	2.82	110	200
315	1000	35x50	2.70	110	200
315	1200	30x60	3.01	89	170
315	1200	35x55	2.92	89	170
315	1200	35x60	2.96	89	170
315	1500	35x60	3.42	68	130
315	1500	35x65	3.62	68	130
350	100	22x25	0.50	1050	1990
350	120	22x25	0.92	870	1660
350	120	22x30	0.94	870	1660
350	150	22x30	1.08	700	1330
350	150	25x25	1.05	700	1330
350	180	22x35	1.22	580	1110
350	180	22x40	1.27	580	1110
350	180	25x30	1.20	580	1110
350	220	22x40	1.39	470	900
350	220	22x45	1.43	470	900
350	220	25x30	1.30	470	900
350	220	25x35	1.35	470	900
350	220	30x25	1.30	470	900
350	270	22x45	1.57	390	740
350	270	22x50	1.62	390	740
350	270	25x35	1.49	390	740
350	270	25x40	1.53	390	740
350	270	30x25	1.34	390	740
350	270	30x30	1.49	390	740
350	270	35x25	1.42	390	740
350	330	22x50	1.77	320	600
350	330	25x40	1.69	320	600
350	330	25x45	1.77	320	600
350	330	30x30	1.56	320	600
350	330	30x35	1.69	320	600
350	330	35x25	1.56	320	600
350	390	22x55	1.96	270	510
350	390	25x45	1.88	270	510
350	390	25x50	1.97	270	510
350	390	30x35	1.77	270	510
350	390	30x40	1.83	270	510
350	390	30x45	1.92	270	510
350	390	35x30	1.66	270	510
350	390	35x35	1.73	270	510
350	470	25x50	2.09	220	420
350	470	25x55	2.14	220	420
350	470	30x40	1.99	220	420
350	470	30x45	2.09	220	420
350	470	30x45	2.09	220	420
350	470	35x35	1.90	220	420
350	560	25x55	2.30	190	360
350	560	25x60	2.38	190	360
350	560	30x45	2.20	190	360
350	560	30x50	2.30	190	360
350	560	35x40	2.13	190	360
350	560	35x45	2.35	190	360
350	680	30x50	2.43	150	290

WV (Vdc)	Cap (uF)	Size (mm)	Rated Ripple current (Arms/105°C /120Hz)	Typ. ESR 20°C 120Hz (mΩ)	MAX ESR 20°C 120Hz (mΩ)
350	680	30x55	2.48	150	290
350	680	35x40	2.17	150	290
350	680	35x45	2.40	150	290
350	820	30x55	2.50	130	240
350	820	30x60	2.65	130	240
350	820	35x45	2.45	130	240
350	820	35x50	2.50	130	240
350	1000	35x50	2.80	110	200
350	1000	35x60	3.00	110	200
350	1000	40x50	3.00	110	200
350	1200	35x60	3.01	89	170
350	1200	35x70	3.23	89	170
350	1200	40x60	3.25	89	170
350	1500	40x80	4.21	68	130
350	1500	45x60	4.06	68	130
350	1800	40x90	4.90	58	110
350	1800	45x70	4.75	58	110
350	2200	45x85	5.40	48	90
350	2700	45x100	6.43	39	74
400	82	22x25	0.55	1280	2430
400	100	22x25	0.66	1050	1990
400	100	22x30	0.68	1050	1990
400	100	25x25	0.68	1050	1990
400	120	22x25	0.70	870	1660
400	120	22x30	0.76	870	1660
400	120	25x25	0.76	870	1660
400	150	22x30	0.85	700	1330
400	150	22x35	0.90	700	1330
400	150	25x25	0.85	700	1330
400	150	25x30	0.90	700	1330
400	180	22x35	0.99	580	1110
400	180	22x40	1.05	580	1110
400	180	25x30	1.05	580	1110
400	180	25x35	1.10	580	1110
400	180	30x25	1.05	580	1110
400	220	22x45	1.12	470	900
400	220	22x50	1.16	470	900
400	220	25x30	1.07	470	900
400	220	25x35	1.12	470	900
400	220	30x25	1.10	470	900
400	220	30x30	1.16	470	900
400	270	22x50	1.26	390	740
400	270	25x40	1.26	390	740
400	270	25x45	1.29	390	740
400	270	30x30	1.26	390	740
400	270	30x35	1.29	390	740
400	270	35x25	1.26	390	740
400	330	22x55	1.45	320	600
400	330	25x40	1.35	320	600
400	330	25x45	1.42	320	600
400	330	30x30	1.35	320	600
400	330	30x35	1.42	320	600
400	330	35x30	1.46	320	600
400	390	25x50	1.62	270	510
400	390	25x55	1.69	270	510
400	390	30x40	1.62	270	510
400	390	30x45	1.69	270	510
400	390	35x30	1.59	270	510
400	390	35x35	1.69	270	510
400	470	30x45	1.88	220	420
400	470	30x50	1.97	220	420
400	470	35x35	1.86	220	420
400	470	35x40	1.96	220	420

WV (Vdc)	Cap (uF)	Size (mm)	Rated Ripple current (Arms/105°C /120Hz)	Typ. ESR 20°C 120Hz (mΩ)	MAX ESR 20°C 120Hz (mΩ)
400	560	35x40	2.13	190	360
400	560	35x45	2.25	190	360
400	680	35x45	2.48	150	290
400	680	35x50	2.60	150	290
400	820	35x55	2.67	130	240
400	820	35x60	2.78	130	240
400	820	40x50	2.78	130	240
400	1000	35x65	3.25	110	200
400	1000	40x55	3.25	110	200
400	1200	35x75	3.72	89	170
400	1200	40x65	3.72	89	170
400	1200	45x55	3.72	89	170
400	1500	40x80	4.56	68	130
400	1500	45x65	4.56	68	130
400	1800	45x80	5.36	58	110
450	82	22x25	0.60	1700	3230
450	100	22x25	0.64	1390	2650
450	100	22x30	0.69	1390	2650
450	100	25x25	0.69	1390	2650
450	120	22x30	0.76	1160	2210
450	120	22x35	0.81	1160	2210
450	120	25x25	0.76	1160	2210
450	120	25x30	0.81	1160	2210
450	150	22x35	0.90	930	1770
450	150	22x40	0.96	930	1770
450	150	25x30	0.90	930	1770
450	150	25x35	0.96	930	1770
450	150	30x25	0.90	930	1770
450	150	30x30	0.96	930	1770
450	180	22x40	1.05	770	1470
450	180	22x45	1.10	770	1470
450	180	25x30	1.05	770	1470
450	180	25x35	1.10	770	1470
450	180	30x25	1.03	770	1470
450	180	30x30	1.11	770	1470
450	180	35x25	1.11	770	1470
450	220	22x45	1.16	640	1210
450	220	25x35	1.15	640	1210
450	220	25x40	1.18	640	1210
450	220	30x30	1.15	640	1210
450	220	30x35	1.20	640	1210
450	220	30x50	1.15	640	1210
450	270	22x55	1.31	520	980
450	270	25x45	1.29	520	980
450	270	25x50	1.31	520	980
450	270	30x30	1.23	520	980
450	270	30x40	1.35	520	980
450	270	35x30	1.35	520	980
450	330	25x50	1.50	420	800
450	330	30x40	1.50	420	800
450	330	30x45	1.58	420	800
450	330	35x30	1.50	420	800
450	330	35x35	1.58	420	800
450	390	25x55	1.69	360	680
450	390	30x45	1.72	360	680
450	390	30x50	1.80	360	680
450	390	35x35	1.72	360	680
450	390	35x40	1.79	360	680
450	470	30x50	1.97	290	560
450	470	30x55	2.06	290	560
450	470	35x40	1.95	290	560
450	470	35x45	2.06	290	560
450	560	30x55	2.24	250	470

WV (Vdc)	Cap (uF)	Size (mm)	Rated Ripple current (Arms/105°C /120Hz)	Typ. ESR 20°C 120Hz (mΩ)	MAX ESR 20°C 120Hz (mΩ)
450	560	35x45	2.16	250	470
450	560	35x50	2.36	250	470
450	680	35x50	2.50	210	390
450	680	35x55	2.62	210	390
450	820	35x65	3.00	170	320
450	820	40x55	3.00	170	320
450	1000	35x70	3.10	140	270
450	1000	35x80	3.56	140	270
450	1000	40x70	3.60	140	270
450	1000	45x60	3.60	140	270
450	1200	40x80	3.95	120	220
450	1500	45x80	4.80	95	180
450	1800	45x90	5.67	79	150
500	47	22x25	0.40	2970	5640
500	56	22x25	0.43	2490	4740
500	56	22x30	0.47	2490	4740
500	56	25x25	0.47	2490	4740
500	68	22x30	0.52	2050	3900
500	68	22x35	0.55	2050	3900
500	68	25x25	0.52	2050	3900
500	68	25x30	0.55	2050	3900
500	82	22x35	0.61	1700	3230
500	82	25x30	0.61	1700	3230
500	100	22x40	0.72	1390	2650
500	100	25x35	0.72	1390	2650
500	100	30x30	0.72	1390	2650
500	120	22x45	0.74	1160	2210
500	120	25x40	0.74	1160	2210

WV (Vdc)	Cap (uF)	Size (mm)	Rated Ripple current (Arms/105°C /120Hz)	Typ. ESR 20°C 120Hz (mΩ)	MAX ESR 20°C 120Hz (mΩ)
500	120	30x35	0.77	1160	2210
500	120	35x30	0.80	1160	2210
500	150	22x50	0.96	930	1770
500	150	25x45	0.98	930	1770
500	150	30x35	0.92	930	1770
500	150	35x30	0.92	930	1770
500	180	25x50	1.13	770	1470
500	180	30x35	1.05	770	1470
500	180	35x30	1.10	770	1470
500	220	25x50	1.22	640	1210
500	220	30x45	1.25	640	1210
500	220	35x30	1.10	640	1210
500	220	35x35	1.23	640	1210
500	270	30x50	1.51	520	980
500	270	35x35	1.31	520	980
500	270	35x40	1.42	520	980
500	330	35x40	1.48	420	800
500	330	35x45	1.56	420	800
500	390	35x50	1.78	360	680
500	470	35x55	2.14	290	560
500	470	35x60	2.26	290	560
500	560	35x65	2.38	250	470
500	680	40x65	2.52	210	390
550	220	35x40	1.30	640	1210
550	270	35x50	1.60	520	980
550	330	35x55	1.63	420	800
550	390	35x60	1.80	360	680
550	470	35x70	2.10	290	560

Useful life

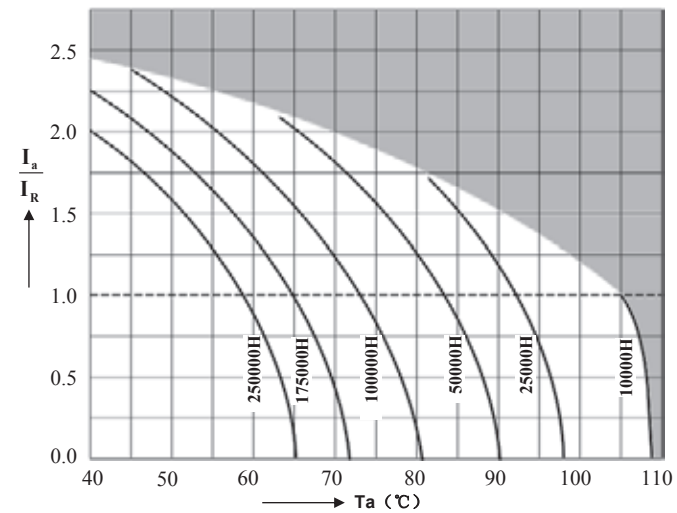

depending on ambient temperature T_a versus under ripple current operating conditions

RS Series 85°C

Features

Extremely Long useful life

Applications

- ◆ Professional power supplies
- ◆ Frequency converters
- ◆ Uninterruptible power supplies

Features

- ◆ Wide temperature range
- ◆ All-welded construction ensures reliable electrical contact
- ◆ Self-extinguishing electrolyte
- ◆ RoHS-compatible

Construction

- ◆ Charge-discharge proof, polar
- ◆ Aluminum case with insulating sleeve
- ◆ Poles with screw terminal connections
- ◆ Mounting with ring clips, clamps or threaded stud



Specifications

Item	Performance Characteristics																																																																		
Operating Temperature Range	-40 to +85°C																																																																		
Rated voltage V_R	10 to 100 V DC																																																																		
Surge voltage V_S	1.15 V_R																																																																		
Rated capacitance C_R	1800 to 1000000 μ F																																																																		
Capacitance tolerance	$\pm 20\%$ (120Hz, +20°C)																																																																		
Leakage Current I_{leak} (+20°C, max.)	$I_{leak} = 0.018x(CxV)^{0.85} + 4$ or 5mA, whichever is smaller (after 5 minutes) Where, I_{leak} : Max. leakage current (μ A), C : Nominal capacitance (μ F), V : Rated voltage (V)																																																																		
Dissipation Factor ($\tan \delta$, at 20°C, 120Hz)	Less than the value under table(%)																																																																		
	<table border="1"> <thead> <tr> <th>ϕ D</th> <th>35</th> <th>51</th> <th>63.5</th> <th>76.2</th> <th>89</th> </tr> </thead> <tbody> <tr> <td>WV</td> <td></td> <td></td> <td></td> <td></td> <td></td> </tr> <tr> <td>10</td> <td>75</td> <td>100</td> <td>120</td> <td>150</td> <td>180</td> </tr> <tr> <td>16</td> <td>60</td> <td>70</td> <td>80</td> <td>120</td> <td>140</td> </tr> <tr> <td>25</td> <td>40</td> <td>50</td> <td>70</td> <td>80</td> <td>130</td> </tr> <tr> <td>35</td> <td>30</td> <td>50</td> <td>60</td> <td>70</td> <td>90</td> </tr> <tr> <td>40</td> <td>30</td> <td>50</td> <td>60</td> <td>70</td> <td>90</td> </tr> <tr> <td>50</td> <td>25</td> <td>30</td> <td>50</td> <td>60</td> <td>80</td> </tr> <tr> <td>63</td> <td>20</td> <td>25</td> <td>30</td> <td>40</td> <td>60</td> </tr> <tr> <td>80</td> <td>20</td> <td>20</td> <td>25</td> <td>30</td> <td>50</td> </tr> <tr> <td>100</td> <td>15</td> <td>20</td> <td>25</td> <td>30</td> <td>30</td> </tr> </tbody> </table>	ϕ D	35	51	63.5	76.2	89	WV						10	75	100	120	150	180	16	60	70	80	120	140	25	40	50	70	80	130	35	30	50	60	70	90	40	30	50	60	70	90	50	25	30	50	60	80	63	20	25	30	40	60	80	20	20	25	30	50	100	15	20	25	30	30
	ϕ D	35	51	63.5	76.2	89																																																													
	WV																																																																		
	10	75	100	120	150	180																																																													
	16	60	70	80	120	140																																																													
	25	40	50	70	80	130																																																													
	35	30	50	60	70	90																																																													
	40	30	50	60	70	90																																																													
	50	25	30	50	60	80																																																													
63	20	25	30	40	60																																																														
80	20	20	25	30	50																																																														
100	15	20	25	30	30																																																														
Self-inductance ESL	d = 35 mm: approx. 10 nH																																																																		
	d = 51 mm: approx. 15 nH																																																																		
	d \geq 63.5 mm: approx. 20 nH																																																																		
Useful life 85°C; $V_R, I_{AC, R}$	Requirements:																																																																		
	$\Delta C/C \leq \pm 45\%$ of initial value																																																																		
	ESR ≤ 3 times initial specified limit																																																																		
	$I_{leak} \leq$ initial specified limit Failure rate $\leq 1\%/1000$ hour																																																																		
Voltage Endurance test 85°C; V_R	2000 h																																																																		
	Post test requirements:																																																																		
	DC/C $\leq \pm 15\%$ of initial value																																																																		
	ESR ≤ 1.3 times initial specified limit $I_{leak} \leq$ initial specified limit																																																																		
Vibration Resistance test	To IEC 60068-2-6, test Fc:																																																																		
	Displacement amplitude 0.75 mm, frequency range 10 ... 55 Hz, acceleration max. 10 g, duration 3x2 h. Capacitor mounted by its body which is rigidly clamped to the work surface.																																																																		
Characteristics at low temperature	Max. impedance ratio at 120 Hz																																																																		
	<table border="1"> <tbody> <tr> <td>$Z_{-25^\circ C} / Z_{20^\circ C}$</td> <td>3</td> </tr> <tr> <td>$Z_{-40^\circ C} / Z_{20^\circ C}$</td> <td>12</td> </tr> </tbody> </table>	$Z_{-25^\circ C} / Z_{20^\circ C}$	3	$Z_{-40^\circ C} / Z_{20^\circ C}$	12																																																														
$Z_{-25^\circ C} / Z_{20^\circ C}$	3																																																																		
$Z_{-40^\circ C} / Z_{20^\circ C}$	12																																																																		
Sectional specification	IEC 60384-4 and JIS-C-5101																																																																		

Multiplier for Ripple Current vs. Frequency

Rated voltage (V)	Case diameter (Φ)	Frequency(Hz)				
		50	120	1K	10K	≥50K
10 to 50	35 to 89	0.95	1	1.05	1.09	1.12
63 & 80	35	0.9	1	1.1	1.18	1.22
	50 to 89	0.95	1	1.05	1.09	1.12
100	35	0.8	1	1.22	1.3	1.33
	50	0.9	1	1.1	1.18	1.22
	63.5 to 89	0.95	1	1.05	1.09	1.12

Dimensional drawings

Ring clip/clamp mounting:

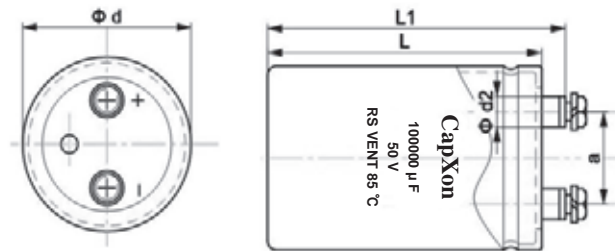

M5:Min.reach of screw = 8mm
M6:Min.reach of screw = 12mm
M8:Min.reach of screw = 16mm

Dimensions

Terminal	Dimensions(mm) with insulating sleeve				
	$d \pm 2$	$L \pm 3$	$L_1 \pm 3$	$d_2 \text{max.}$	$a \pm 0.5$
M5	35	50~120	56.5~126.5	10.3	12.7
M5	51	80~140	86.5~146.5	10.3	22
M5	63.5	80~140	86.5~146.5	10.3	28.6
M5	76.2/89	100~240	106.4~246.5	10.3	31.8
M6	76.2/89	100~240	106.4~246.5	17.5	31.8
M8	100	100~240	110~250	17.5	41.5

Packing

Capacitor diameter d(mm)	length l(mm)	Packing units (pcs.)
35	≤70mm	120
	>70mm	60
42	≤70mm	120
	>70mm	60
51	≤70mm	70
	>70mm	35
63.5	all	24
76.2	all	15
89	all	12
100	all	6

Packing of screw

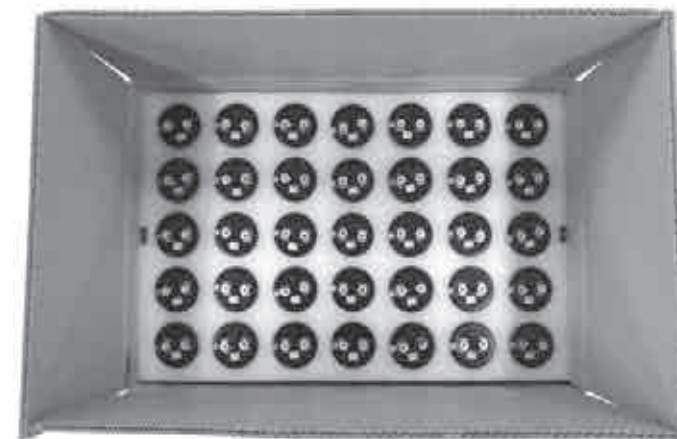

Accessories

The following items are included in the delivery package, but are not fastened to the capacitors.

	Thread	Maximum torque
For terminals	M5	2 Nm
	M6	2.5 Nm
	M8	5.0 Nm
For mounting	M12	10 Nm

Case Size

WV (Vdc)	Cap (uF)	Size (mm)	Rated Ripple current (Arms/85°C /120Hz)	Typ. ESR 20°C 120Hz (mΩ)	MAX ESR 20°C 120Hz (mΩ)
10	33000	35x50	4.5	15	28
10	39000	35x50	4.8	13	24
10	47000	35x65	5.4	11	21
10	56000	35x65	6.0	10	18
10	68000	35x80	7.6	9	15
10	82000	35x80	7.7	8	12
10	100000	35x100	9.3	7	10
10	120000	35x120	9.5	6	10
10	150000	51x80	10.1	5	8.5
10	180000	51x80	10.8	5	8.6
10	220000	51x100	13.0	5	8.6
10	270000	51x120	14.0	4	7.6
10	330000	63.5x96	15.6	4	7.0
10	390000	63.5x100	16.2	4	6.7
10	470000	63.5x120	18.1	3	6.1
10	560000	76.2x100	18.4	3	5.7
10	680000	76.2x120	19.0	3	5.7
10	820000	76.2x155	24.0	3	5.7
16	22000	35x50	5.0	14	25
16	27000	35x50	6.3	12	22
16	33000	35x60	8.5	11	19
16	33000	35x80	9.5	11	19
16	47000	35x100	10.0	8	15
16	47000	35x80	9.0	8	15
16	56000	35x80	9.8	7	13
16	68000	35x100	10.5	7	13
16	68000	35x105	10.8	7	13
16	68000	51x80	12.0	7	13
16	82000	35x100	12.0	6	11
16	100000	35x120	12.5	5	10
16	100000	51x100	14.0	5	10
16	100000	51x80	13.0	5	10
16	120000	35x120	14.2	5	10
16	120000	51x80	14.8	5	10
16	150000	51x100	16.0	5	8.6
16	150000	51x140	17.2	5	8.6
16	150000	51x80	15.0	5	8.6
16	220000	51x120	14.5	4	7.6
16	220000	51x140	15.6	4	7.6
16	220000	63.5x105	17.0	4	7.6
16	220000	63.5x120	18.0	4	7.6
16	270000	63.5x100	18.5	4	6.7
16	270000	63.5x96	18.2	4	6.7
16	330000	63.5x105	19.0	4	6.7
16	330000	63.5x120	20.1	4	6.7
16	330000	63.5x140	21.5	4	6.7
16	330000	76.2x120	22.0	4	6.7
16	390000	63.5x130	22.5	3	5.7
16	390000	76.2x100	22.8	3	5.7
16	390000	76.2x120	24.7	3	5.7
16	470000	76.2x115	25.0	3	5.7
16	470000	76.2x120	25.5	3	5.7
16	470000	76.2x140	27.3	3	5.7
16	560000	76.2x130	27.6	3	5.5
16	560000	76.2x140	28.5	3	5.5
16	680000	76.2x145	28.7	3	5.5
16	680000	76.2x160	30.1	3	5.5
16	820000	76.2x220	31.0	3	5.0
16	1000000	89x160	32.0	3	5.0
16	1000000	89x200	35.3	3	5.0
25	15000	35x50	4.0	18.0	35
25	18000	35x50	4.5	16.0	29
25	22000	35x60	5.5	13.0	24

WV (Vdc)	Cap (uF)	Size (mm)	Rated Ripple current (Arms/85°C /120Hz)	Typ. ESR 20°C 120Hz (mΩ)	MAX ESR 20°C 120Hz (mΩ)
25	27000	35x65	6.9	12.0	20
25	33000	35x80	8.2	10.0	19
25	39000	35x80	9.0	9.0	17
25	47000	35x100	9.5	8.0	15
25	47000	35x105	9.7	8.0	15
25	47000	35x120	10.3	8.0	15
25	56000	35x100	10.5	7.0	13
25	56000	35x120	11.4	7.0	13
25	68000	35x120	12.0	6.0	11
25	68000	51x80	12.3	6.0	11
25	82000	35x120	12.5	6.5	12
25	82000	51x80	12.8	6.5	12
25	100000	51x100	13.4	5.0	10
25	100000	51x105	13.7	5.0	10
25	120000	51x115	14.0	4.5	8.6
25	120000	51x120	14.3	4.5	8.6
25	150000	51x120	15.0	4.0	7.6
25	150000	51x140	16.1	4.0	7.6
25	150000	63.5x105	16.2	4.0	7.6
25	180000	63.5x120	16.8	3.8	7.2
25	220000	63.5x105	17.0	3.5	6.7
25	220000	63.5x120	18.0	3.5	6.7
25	270000	63.5x130	18.8	3.3	6.3
25	270000	76.2x100	19.3	3.3	6.3
25	330000	76.2x120	21.0	3.2	6.1
25	330000	76.2x140	22.5	3.2	6.1
25	390000	76.2x115	22.8	3.0	5.7
25	390000	76.2x140	24.8	3.0	5.7
25	470000	76.2x150	25.3	3.0	5.7
25	560000	89x130	26.0	3.0	5.7
25	560000	89x140	26.8	3.0	5.7
25	680000	89x160	27.5	3.0	5.7
25	820000	89x190	30.0	3.0	5.7
25	1000000	89x220	33.0	3.0	5.7
35	10000	35x50	4.0	19.0	40
35	12000	35x50	4.3	17.0	33
35	15000	35x50	4.5	14.0	27
35	15000	35x80	5.5	14.0	27
35	18000	35x80	6.0	12.0	22
35	22000	35x100	7.0	10.0	18
35	22000	35x80	6.3	10.0	18
35	27000	35x100	8.0	9.0	17
35	27000	35x80	7.2	9.0	17
35	33000	35x100	9.3	8.0	15
35	33000	35x80	8.4	8.0	15
35	39000	35x100	10.0	7.0	13
35	39000	35x120	10.9	7.0	13
35	47000	35x120	11.5	6.0	11
35	47000	51x96	12.8	6.0	11
35	56000	51x96	13.3	5.5	10
35	68000	51x100	15.4	5.0	10
35	68000	51x80	14.0	5.0	10
35	82000	51x100	16.0	4.5	9
35	82000	63.5x96	17.7	4.5	9
35	100000	51x120	18.5	4.0	8
35	100000	63.5x100	19.3	4.0	8
35	100000	63.5x115	20.5	4.0	8
35	120000	51x120	21.0	3.5	6.7
35	120000	63.5x120	23.0	3.5	6.7
35	150000	63.5x100	23.7	3	5.7
35	150000	63.5x120	25.7	3	5.7
35	180000	63.5x120	26.2	3	5.7
35	180000	76.2x115	27.0	3	5.7

WV (Vdc)	Cap (uF)	Size (mm)	Rated Ripple current (Arms/85°C /120Hz)	Typ. ESR 20°C 120Hz (mΩ)	MAX ESR 20°C 120Hz (mΩ)
35	220000	76.2x100	27.6	3	5.5
35	220000	76.2x140	31.9	3	5.5
35	220000	76.2x145	32.4	3	5.5
35	270000	76.2x120	32.7	3	5.4
35	330000	76.2x140	33.1	3	5.3
35	330000	76.2x160	35.1	3	5.3
35	330000	89x130	35.5	3	5.3
35	390000	89x155	36.0	3	5.2
35	470000	89x140	37.0	3	5.1
35	470000	89x170	40.3	3	5.1
35	680000	89x220	43.0	3	5.0
40	10000	35x55	6.3	19	37
40	15000	35x80	9.0	14	27
40	22000	35x80	11.0	10	18
40	33000	35x105	12.0	8	15
40	47000	51x80	14.2	6	11
40	68000	51x105	15.5	5	10
40	100000	63.5x105	17.0	4	7.6
40	150000	76.2x105	19.0	3	5.7
40	220000	76.2x140	21.0	3	5.7
50	6800	35x50	3.7	22	42
50	10000	35x50	6.4	16	30
50	10000	35x60	6.6	16	30
50	12000	35x65	6.9	13	25
50	12000	35x80	7.2	13	25
50	15000	35x80	8.7	11	21
50	18000	35x100	8.8	10	18
50	18000	35x80	8.5	10	18
50	22000	35x100	10.0	8	15
50	22000	35x120	10.5	8	15
50	27000	35x120	10.0	7	13
50	33000	51x100	11.0	6	11
50	33000	51x80	11.8	6	11
50	39000	51x100	12.5	6	10
50	39000	51x80	12.0	6	10
50	47000	51x100	12.8	5	10
50	47000	51x115	13.0	5	10
50	56000	51x100	13.0	4	7.6
50	56000	63.5x96	13.5	4	7.6
50	68000	51x120	13.0	3	7.5
50	68000	51x140	13.5	3	7.5
50	68000	63.5x96	13.5	3	7.5
50	82000	63.5x100	14.0	3	7.0
50	82000	63.5x115	14.0	3	7.0
50	100000	63.5x120	14.5	3	6.8
50	100000	63.5x140	15.5	3	6.8
50	100000	76.2x100	14.0	3	6.8
50	100000	76.2x115	15.0	3	6.8
50	120000	63.5x120	16.0	3	6.5
50	120000	63.5x145	17.0	3	6.5
50	120000	76.2x115	17.0	3	6.5
50	150000	76.2x120	18.2	3	6.2
50	150000	76.2x130	18.8	3	6.2
50	150000	76.2x140	19.0	3	6.2
50	180000	76.2x140	20.0	3	6.0
50	180000	76.2x145	21.0	3	6.0
50	180000	76.2x155	22.0	3	6.0
50	220000	76.2x160	21.5	3	5.5
50	220000	89x130	21.5	3	5.5
50	270000	89x140	24.7	3	5.2
50	270000	89x155	25.5	3	5.2
50	330000	89x160	26.0	3	5.0
63	3900	35x50	2.6	42	68
63	4700	35x50	4.7	30	56
63	4700	35x55	4.8	30	56

WV (Vdc)	Cap (uF)	Size (mm)	Rated Ripple current (Arms/85°C /120Hz)	Typ. ESR 20°C 120Hz (mΩ)	MAX ESR 20°C 120Hz (mΩ)
63	5600	35x50	5.0	24	47
63	5600	35x55	5.3	24	47
63	6800	35x50	5.2	22	39
63	6800	35x55	5.9	22	39
63	6800	35x65	6.2	22	39
63	8200	35x65	6.5	18	32
63	8200	35x80	6.8	18	32
63	10000	35x60	6.9	16	27
63	10000	35x80	7.5	16	27
63	12000	35x100	8.8	14	22
63	12000	35x80	8.0	14	22
63	15000	35x105	10.0	11	21
63	18000	35x100	10.0	10	19
63	18000	35x120	10.5	10	19
63	22000	51x80	11.0	8.0	15
63	27000	51x80	11.5	7.0	13
63	27000	51x96	12.0	7.0	13
63	33000	51x100	13.5	6.0	11
63	33000	51x105	14.0	6.0	11
63	39000	51x100	14.0	5.5	10
63	39000	51x115	14.5	5.5	10
63	39000	51x120	15.0	5.5	10
63	47000	51x120	16.5	5.0	10
63	47000	51x130	17.0	5.0	10
63	47000	63.5x100	17.0	5.0	10
63	47000	63.5x105	19.0	5.0	10
63	56000	63.5x100	17.0	4.0	7.6
63	56000	63.5x115	18.5	4.0	7.6
63	68000	63.5x120	19.0	3.0	7.4
63	68000	63.5x145	20.5	3.0	7.4
63	68000	76.2x105	20.2	3.0	7.4
63	82000	63.5x130	20.5	3.0	7.2
63	82000	63.5x145	21.0	3.0	7.2
63	100000	76.2x115	22.0	3.0	7.0
63	100000	76.2x120	23.0	3.0	7.0
63	100000	76.2x130	24.0	3.0	7.0
63	100000	76.2x140	25.0	3.0	7.0
63	120000	76.2x130	26.0	3.0	6.8
63	120000	76.2x140	27.0	3.0	6.8
63	120000	76.2x145	27.5	3.0	6.8
63	150000	76.2x155	28.5	3.0	6.5
63	150000	76.2x220	31.0	3.0	6.5
63	150000	89x140	28.5	3.0	6.5
63	180000	89x130	29.0	3.0	6.0
63	220000	89x155	31.0	3.0	5.5
63	220000	89x160	31.5	3.0	5.5
63	270000	76.2x220	32.0	3.0	5.2
63	330000	89x220	34.0	3	5.0
80	3300	35x50	2.5	50.0	80
80	3900	35x50	2.8	36	68
80	4700	35x60	5.0	25	46
80	5600	35x65	5.5	22	40
80	5600	35x80	6.0	22	40
80	6800	35x60	6.3	19	35
80	6800	35x80	6.5	19	35
80	8200	35x80	7.2	17	32
80	10000	35x100	8.5	13	23
80	10000	35x80	8.0	13	23
80	12000	35x100	9.2	11.0	20
80	12000	35x120	9.5	11.0	20
80	15000	35x120	10.5	9.0	17
80	15000	51x80	10.5	9.0	17
80	18000	35x120	11.0	8.0	15
80	18000	51x80	11.0	8.0	15
80	22000	51x100	12.0	7.0	12

WV (Vdc)	Cap (uF)	Size (mm)	Rated Ripple current (Arms/85°C /120Hz)	Typ. ESR 20°C 120Hz (mΩ)	MAX ESR 20°C 120Hz (mΩ)
80	22000	51x96	11.8	7.0	12
80	27000	51x96	13.0	6.5	11
80	27000	63.5x100	15.0	6.5	11
80	33000	51x115	14.8	6.0	11
80	33000	51x120	15.2	6.0	11
80	33000	63.5x100	15.2	6.0	11
80	39000	51x130	16.0	5.8	11.0
80	39000	63.5x120	16.5	5.8	11.0
80	47000	63.5x115	20.0	5.5	10.5
80	47000	63.5x120	20.5	5.5	10.5
80	47000	63.5x145	21.0	5.5	10.5
80	56000	63.5x130	22.0	5.2	9.5
80	56000	63.5x145	23.0	5.2	9.5
80	68000	76.2x115	22.0	5.0	9.5
80	68000	76.2x120	23.0	5.0	9.5
80	68000	76.2x145	24.0	5.0	9.5
80	82000	76.2x130	24.0	4.5	8.6
80	82000	76.2x140	24.5	4.5	8.6
80	82000	76.2x145	25.0	4.5	8.6
80	100000	76.2x155	25.5	4.0	7.6
80	100000	76.2x160	26.0	4.0	7.6
80	100000	89x140	26.0	4.0	7.6
80	120000	89x130	23.0	3.8	7.2
80	150000	89x155	29.0	3.5	6.7
80	150000	89x160	30.0	4	7
80	220000	89x230	33.0	3	6
100	1800	35x50	3.5	50	90
100	2200	35x50	4.3	40	75
100	2700	35x50	4.5	35	65
100	3300	35x65	4.8	28	53
100	3300	35x80	5.3	28	53
100	3900	35x80	5.6	24	42
100	4700	35x80	6.7	20	36
100	5600	35x100	7.2	18	29
100	6800	35x100	7.5	15	24
100	6800	35x105	8.7	15	24
100	6800	35x80	8.0	15	24
100	8200	35x120	9.5	12	20
100	8200	51x80	9.5	12	20

WV (Vdc)	Cap (uF)	Size (mm)	Rated Ripple current (Arms/85°C /120Hz)	Typ. ESR 20°C 120Hz (mΩ)	MAX ESR 20°C 120Hz (mΩ)
100	10000	35x120	10.0	12	18
100	10000	51x80	10.0	9	18
100	12000	51x80	10.5	9	16
100	15000	51x100	12.4	8	15
100	15000	51x105	13.0	8	15
100	15000	51x80	11.0	8.0	15
100	15000	51x96	11.5	8.0	15
100	18000	51x100	12.6	7.0	14
100	18000	51x115	14.0	7.0	14
100	18000	51x120	14.5	7.0	14
100	18000	63.5x100	15.0	7.0	14
100	22000	51x100	13.3	6.0	11
100	22000	51x120	15.5	6.0	11
100	22000	51x130	16.0	6.0	11
100	22000	63.5x100	16.5	6.0	11
100	22000	63.5x105	17.0	6.0	11
100	27000	63.5x115	18.0	5.5	10.0
100	27000	63.5x120	18.5	5.5	10.0
100	33000	51x140	18.5	5.0	9.0
100	33000	63.5x130	18.8	5.0	9.0
100	33000	63.5x145	19.0	5.0	9.0
100	33000	76.2x100	18.8	5.0	9.0
100	33000	76.2x105	19.0	5.0	9.0
100	39000	76.2x115	20.2	4.8	8.8
100	39000	76.2x120	20.5	4.8	8.8
100	39000	76.2x145	21.0	4.8	8.8
100	47000	63.5x140	22.0	4.5	8.6
100	47000	76.2x130	24.0	4.5	8.6
100	47000	76.2x140	25.0	4.5	8.6
100	47000	76.2x145	25.2	4.5	8.6
100	56000	76.2x155	26.0	4.3	8.2
100	68000	76.2x140	26.4	4.0	7.6
100	68000	89x130	26.5	4.0	7.6
100	68000	89x140	26.7	4.0	7.6
100	82000	89x155	27.0	3.8	7.2
100	100000	89x160	27.2	3.5	6.7
100	100000	89x170	27.5	4	7
100	150000	89x230	31.0	3	6

Useful life

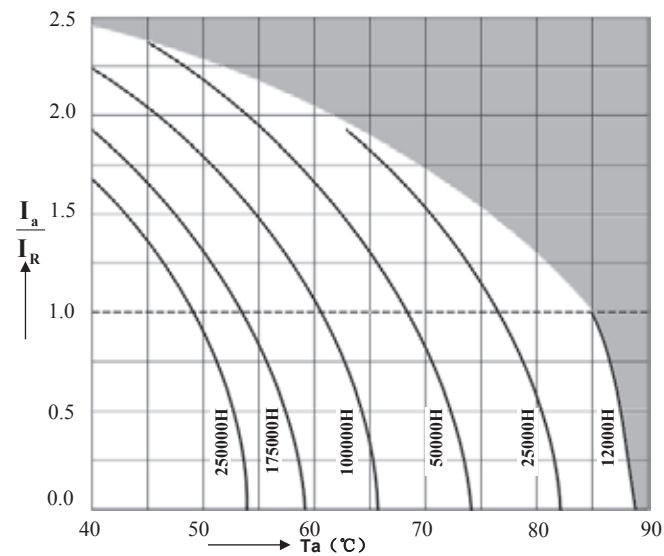

depending on ambient temperature T_a versus under ripple current operating conditions

RG Series 85°C

Features

Standard capacitors

Applications

- ◆ Frequency converters
- ◆ Uninterruptible power supplies

Features

- ◆ All-welded construction ensures reliable electrical contact
- ◆ Self-extinguishing electrolyte
- ◆ RoHS-compatible

Construction

- ◆ Charge-discharge proof, polar
- ◆ Aluminum case with insulating sleeve
- ◆ Poles with screw terminal connections
- ◆ Mounting with ring clips, clamps



Specifications

Item	Performance Characteristics		
Operating Temperature Range	-40 to +85°C		-25 to +85°C
Rated voltage V_R	160 to 450 V DC		500 to 630 V DC
Surge voltage V_S	$V_R \leq 315V$ 1.15 V_R $V_R > 315V$ 1.10 V_R		
Rated capacitance C_R	390 to 39000 μF		1000 to 10000 μF
Capacitance tolerance	$\pm 20\%$ (120Hz, +20°C)		
Leakage Current I_{leak} (+20°C, max.)	$I_{leak} = 0.018 \times (C \times V)^{0.85} + 4$ or 5mA, whichever is smaller (after 5 minutes) Where, I_{leak} : Max. leakage current (μA), C : Nominal capacitance (μF), V : Rated voltage (V)		
Dissipation Factor ($\tan \delta$, at 20°C, 120Hz)	Less than the value under table(%)		
	Working Voltage(VDC)	160~450	500~550 ≥ 600
Self-inductance ESL	d = 51 mm: approx. 17 nH		
	d ≥ 63.5 mm: approx. 20 nH		
	Capacitors with low-inductance design:		
	d ≥ 63.5 mm: approx. 15 nH		
Useful life 85°C; $V_R, I_{AC, R}$	>6000 h	Requirements:	
		$\Delta C/C$	$\leq \pm 15\%$ of initial value
Voltage Endurance test 85°C; V_R	2000 h	$\tan \delta$	≤ 1.75 times initial specified limit
		I_{leak}	\leq initial specified limit
		Post test requirements:	
		$\Delta C/C$	$\leq \pm 10\%$ of initial value
Vibration Resistance test	To IEC 60068-2-6, test Fc:		
	Displacement amplitude 0.75 mm, frequency range 10 ... 55 Hz, acceleration max. 10 g, duration 3x2 h. Capacitor mounted by its body which is rigidly clamped to the work surface.		
Characteristics at low temperature	Max. impedance ratio at 120 Hz		
	$V_R(V)$	160-450	≥ 500
	$Z_{-25^\circ C} / Z_{20^\circ C}$	4	4
Sectional specification	$Z_{-40^\circ C} / Z_{20^\circ C}$	10	-
	IEC 60384-4 and JIS-C-5101		

Screw

Multiplier for Ripple Current vs. Frequency

Frequency(Hz)	50	120	300	1K	$\geq 3K$
Multiplier	0.8	1	1.2	1.3	1.4

Dimensional drawings

Ring clip/clamp mounting:

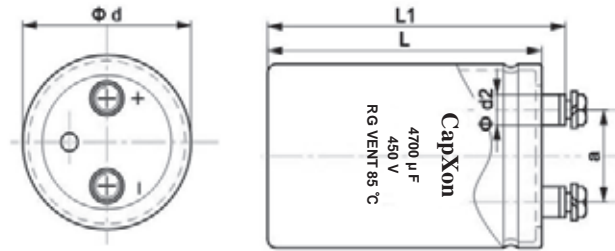

M5:Min.reach of screw = 8mm
 M6:Min.reach of screw = 12mm
 M8:Min.reach of screw = 16mm

Dimensions

Terminal	Dimensions(mm) with insulating sleeve				
	$d \pm 2$	$L \pm 3$	$L_1 \pm 3$	$d_2 \text{max.}$	$a \pm 0.5$
M5	35	50~120	56.5~126.5	10.3	12.7
M5	51	80~140	86.5~146.5	10.3	22
M5	63.5	80~140	86.5~146.5	10.3	28.6
M5	76.2/89	100~240	106.4~246.5	10.3	31.8
M6	76.2/89	100~240	106.4~246.5	17.5	31.8
M8	100	100~240	110~250	17.5	41.5

Packing

Capacitor diameter d(mm)	length l(mm)	Packing units (pcs.)
35	≤ 70 mm	120
	> 70 mm	60
42	≤ 70 mm	120
	> 70 mm	60
51	≤ 70 mm	70
	> 70 mm	35
63.5	all	24
76.2	all	15
89	all	12
100	all	6

Packing of screw



Accessories

The following items are included in the delivery package, but are not fastened to the capacitors.

	Thread	Maximum torque
For terminals	M5	2 Nm
	M6	2.5 Nm
	M8	5.0 Nm
For mounting	M12	10 Nm

Case Size

WV (Vdc)	Cap (uF)	Size (mm)	Rated Ripple current (Arms/85°C /120Hz)	Typ. ESR 20°C 120Hz (mΩ)	MAX ESR 20°C 120Hz (mΩ)
160	1000	35x60	2.8	120	200
160	1500	35x60	3.0	76	130
160	2200	35x100	4.0	53	90
160	3300	35x100	4.7	35	60
160	3900	51x75	5.3	30	51
160	4700	51x75	6.0	25	42
160	5600	51x96	7.0	21	36
160	6800	51x96	8.5	17	29
160	8200	51x115	9.2	14	24
160	10000	51x120	10.5	12	20
160	10000	63.5x96	10.5	12	20
160	12000	51x120	11.5	10	17
160	12000	63.5x100	11.7	10	17
160	15000	63.5x120	14.3	8	13
160	18000	63.5x130	15.6	7	11
160	22000	76.2x120	16.7	5	9
160	27000	76.2x130	20.2	4	7
160	33000	89x130	23.8	4	6
160	39000	89x157	27.9	3	5
200	1000	35x60	3.0	120	200
200	1500	35x80	3.3	76	130
200	2200	35x100	4.2	53	90
200	2700	35x120	4.7	43	74
200	3300	35x120	4.8	35	60
200	3300	51x80	4.9	35	60
200	3900	51x75	5.5	30	51
200	4700	51x96	6.4	25	42
200	5600	51x115	7.6	21	36
200	6800	51x130	8.8	17	29
200	8200	63.5x96	9.4	14	24
200	10000	63.5x120	11.2	12	20
200	10000	63.5x96	10.4	12	20
200	15000	76.2x96	14.4	8	13
200	18000	76.2x130	16.5	7	11
200	22000	76.2x155	19.6	5	9
200	22000	89x120	19.2	5	9
200	27000	89x130	21.5	4	7
200	33000	89x157	25.3	4	6
250	680	35x60	1.8	170	290
250	1000	35x80	3.3	120	200
250	1500	35x80	3.5	76	130
250	1800	35x100	3.5	65	110
250	2200	35x120	3.8	53	90
250	2200	51x75	4.0	53	90
250	2700	51x75	4.4	43	74
250	3300	51x96	5.4	35	60
250	3900	51x115	6.3	30	51
250	4700	51x120	7.0	25	42
250	4700	63.5x96	7.3	25	42
250	5600	63.5x96	7.8	21	36
250	6800	51x140	8.5	17	29
250	6800	63.5x115	9.1	17	29
250	6800	76.2x100	9.5	17	29
250	8200	63.5x115	10.0	14	24
250	10000	63.5x130	11.7	12	20
250	10000	76.2x115	12.2	12	20
250	12000	76.2x115	12.9	10	17
250	15000	76.2x130	15.1	8	13

WV (Vdc)	Cap (uF)	Size (mm)	Rated Ripple current (Arms/85°C /120Hz)	Typ. ESR 20°C 120Hz (mΩ)	MAX ESR 20°C 120Hz (mΩ)
250	15000	89x120	15.9	8	13
250	18000	76.2x155	17.7	7	11
250	22000	89x157	20.9	5	9
350	390	35x50	1.7	300	510
350	470	35x80	2.2	250	420
350	560	35x80	2.4	210	360
350	680	35x80	2.6	170	290
350	820	35x100	3.1	140	240
350	1000	35x100	3.5	120	200
350	1200	51x75	3.8	100	170
350	1500	51x75	4.3	76	130
350	1800	51x80	7.0	65	110
350	2200	51x96	8.0	53	90
350	2700	51x105	9.1	43	74
350	2700	63.5x80	9.2	43	74
350	3300	51x115	10.3	35	60
350	3300	63.5x96	10.9	35	60
350	3900	51x130	11.5	30	51
350	3900	63.5x100	11.7	30	51
350	4700	63.5x100	15.1	25	42
350	5600	63.5x115	17.5	21	36
350	5600	76.2x96	18.2	21	36
350	6800	63.5x140	20.5	17	29
350	6800	76.2x100	20.1	17	29
350	8200	76.2x115	23.4	14	24
350	10000	76.2x135	27.7	12	20
350	10000	89x120	28.7	12	20
350	12000	76.2x168	30.1	10	17
350	12000	89x125	28.9	10	17
350	15000	89x150	34.9	8	13
400	1000	51x75	3.5	120	200
400	1200	51x75	3.9	100	170
400	1500	51x80	6.6	76	130
400	1800	51x96	7.5	65	110
400	2200	51x105	8.5	53	90
400	2200	63.5x80	8.0	53	90
400	2700	51x118	9.7	43	74
400	2700	63.5x96	10.0	43	74
400	3300	63.5x96	12.6	35	60
400	3900	63.5x100	13.7	30	51
400	4700	63.5x115	16.0	25	42
400	4700	76.2x96	16.7	25	42
400	5600	63.5x130	18.4	21	36
400	5600	76.2x105	18.6	21	36
400	6800	76.2x110	20.9	17	29
400	8200	76.2x130	24.7	14	24
400	10000	76.2x160	26.9	12	20
400	10000	89x125	26.4	12	20
400	12000	76.2x190	31.8	10	17
400	12000	89x145	30.8	10	17
400	15000	89x236	38.2	8	13
450	1000	51x75	3.5	120	200
450	1200	51x80	5.4	100	170
450	1500	51x96	6.2	76	130
450	1500	63.5x80	6.3	76	130
450	1800	51x96	7.9	65	110
450	2200	51x118	8.0	53	90
450	2200	63.5x96	8.3	53	90

WV (Vdc)	Cap (uF)	Size (mm)	Rated Ripple current (Arms/85°C /120Hz)	Typ. ESR 20°C 120Hz (mΩ)	MAX ESR 20°C 120Hz (mΩ)
450	2700	63.5x100	11.4	43	74
450	3300	63.5x105	12.9	35	60
450	3900	63.5x115	14.6	30	51
450	3900	76.2x100	15.2	30	51
450	4700	63.5x135	17.2	25	42
450	4700	76.2x105	17.0	25	42
450	5600	76.2x115	19.3	21	36
450	6800	76.2x135	22.8	17	29
450	10000	76.2x190	29.0	12	20
450	10000	89x150	28.5	12	20
450	12000	89x236	33.0	10	17
500	1000	51x115	4.6	160	270
500	1000	51x85	4.0	160	270
500	1200	51x96	4.2	130	220
500	1500	51x115	5.1	110	180
500	1500	63.5x96	5.4	110	180
500	1800	51x130	5.9	88	150
500	1800	63.5x96	6.0	88	150
500	2200	63.5x115	7.1	71	120
500	2200	76.2x96	7.3	71	120
500	2700	63.5x130	8.3	58	98
500	3300	76.2x115	9.7	47	80
500	3900	76.2x130	11.1	40	68
500	4700	76.2x155	13.1	33	56
500	5600	89x145	13.8	28	47
500	6800	89x155	15.9	23	39
500	8200	89x180	17.2	19	32
500	10000	89x236	22.1	16	27
550	1200	51x115	4.6	130	220
550	1500	63.5x96	5.4	110	180
550	1800	76.2x80	6.1	88	150

WV (Vdc)	Cap (uF)	Size (mm)	Rated Ripple current (Arms/85°C /120Hz)	Typ. ESR 20°C 120Hz (mΩ)	MAX ESR 20°C 120Hz (mΩ)
550	2200	76.2x96	7.3	71	120
550	2700	76.2x115	8.7	58	98
550	3300	76.2x130	10.2	47	80
550	3900	76.2x155	12.1	40	68
550	4700	76.2x180	15.1	33	56
550	5600	89x155	14.5	28	47
600	1200	63.5x96	7.7	160	280
600	1500	63.5x115	8.3	130	220
600	1500	76.2x96	8.5	130	220
600	1800	63.5x130	10.3	110	180
600	1800	76.2x96	10.1	110	180
600	2200	76.2x115	12.0	88	150
600	2700	76.2x130	12.1	71	120
600	3000	76.2x155	15.6	65	110
600	3300	76.2x155	16.4	59	100
600	3300	89x130	16.6	59	100
600	3900	76.2x190	17.7	50	85
600	3900	89x145	17.4	50	85
600	4700	89x157	21.0	41	71
600	5600	89x190	22.8	35	59
600	6800	89x220	24.4	29	49
630	1000	63.5x130	6.0	190	330
630	1200	76.2x115	6.7	160	280
630	1500	76.2x130	8.1	130	220
630	1800	76.2x155	9.8	110	180
630	2200	89x130	10.7	88	150
630	2700	89x157	12.8	71	120
630	3300	89x171	14.7	59	100
630	3900	89x196	17.9	50	85
630	4700	100x220	21.6	41	71
630	5600	100x250	24.9	35	59

Useful life

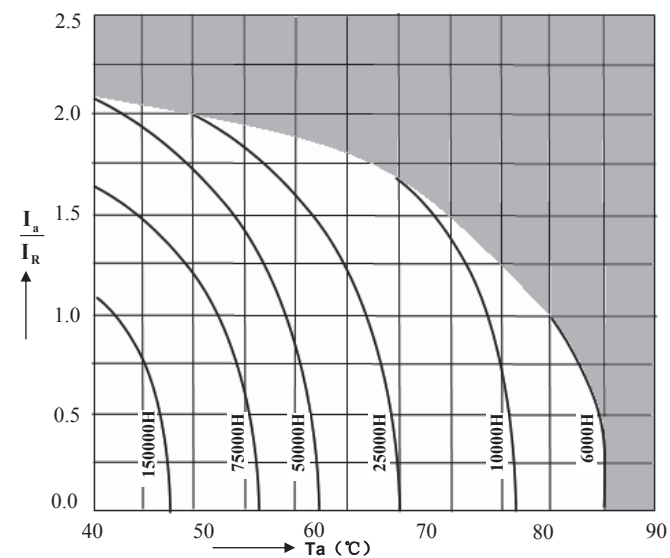

depending on ambient temperature T_a versus under ripple current operating conditions

RP Series 85°C

Features

Extremely Long useful life

Applications

- ◆ Professional power supplies
- ◆ Frequency converters
- ◆ Uninterruptible power supplies

Features

- ◆ Long useful life
- ◆ High reliability
- ◆ Version with low-inductance design available
- ◆ All-welded construction ensures reliable electrical contact
- ◆ Self-extinguishing electrolyte
- ◆ RoHS-compatible

Construction

- ◆ Charge-discharge proof, polar
- ◆ Aluminum case with insulating sleeve
- ◆ Poles with screw terminal connections
- ◆ Mounting with ring clips, clamps or threaded stud



Specifications

Item	Performance Characteristics	
Operating Temperature Range	-40 to +85°C	-25 to +85°C
Rated voltage V_R	160 to 450 V DC	500 to 630 V DC
Surge voltage V_S	$V_R \leq 315V$ 1.15 V_R $V_R > 315V$ 1.10 V_R	
Rated capacitance C_R	270 to 68000 μF	100 to 10000 μF
Capacitance tolerance	$\pm 20\%$ (120Hz, +20°C)	
Leakage Current I_{leak} (+20°C, max.)	$I_{leak} = 0.018 \times (C \times V)^{0.85} + 4$ or 5mA, whichever is smaller (after 5 minutes) Where, I_{leak} : Max. leakage current (μA), C : Nominal capacitance (μF), V : Rated voltage (V)	
Dissipation Factor ($\tan \delta$, at 20°C, 120Hz)	Less than the value under table(%)	
	Working Voltage(VDC)	160~450 500~550 ≥ 600
	D.F. (%)max.	15 20 25
Self-inductance ESL	d = 51 mm: approx. 17 nH	
	d ≥ 63.5 mm: approx. 20 nH	
	Capacitors with low-inductance design:	
	d ≥ 63.5 mm: approx. 15 nH	
Useful life 85°C; $V_R, I_{AC,R}$	>10000 h	Requirements:
		$\Delta C/C$ $\leq \pm 15\%$ of initial value $\tan \delta$ ≤ 1.75 times initial specified limit I_{leak} \leq initial specified limit
Voltage Endurance test 85°C; V_R	2000 h	Post test requirements:
		$\Delta C/C$ $\leq \pm 10\%$ of initial value $\tan \delta$ ≤ 1.3 times initial specified limit I_{leak} \leq initial specified limit
Vibration Resistance test	To IEC 60068-2-6, test Fc: Displacement amplitude 0.75 mm, frequency range 10 ... 55 Hz, acceleration max. 10 g, duration 3x2 h. Capacitor mounted by its body which is rigidly clamped to the work surface.	
Characteristics at low temperature	Max. impedance ratio at 120 Hz	
	$V_R(V)$	160-450 ≥ 500
	$Z_{-25^\circ C} / Z_{20^\circ C}$	4 4
	$Z_{-40^\circ C} / Z_{20^\circ C}$	10 -
Sectional specification	IEC 60384-4 and JIS-C-5101	

Screw

Multiplier for Ripple Current vs. Frequency

Frequency(Hz)	50	120	300	1K	$\geq 3K$
Multiplier	0.8	1	1.2	1.3	1.4

Dimensional drawings

Ring clip/clamp mounting:

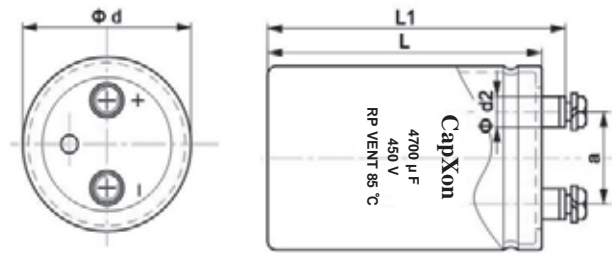

M5:Min.reach of screw = 8mm
 M6:Min.reach of screw = 12mm
 M8:Min.reach of screw = 16mm

Dimensions

Terminal	Dimensions(mm) with insulating sleeve				
	$d \pm 2$	$L \pm 3$	$L_1 \pm 3$	$d_2 \text{max.}$	$a \pm 0.5$
M5	35	50~120	56.5~126.5	10.3	12.7
M5	51	80~140	86.5~146.5	10.3	22
M5	63.5	80~140	86.5~146.5	10.3	28.6
M5	76.2/89	100~240	106.4~246.5	10.3	31.8
M6	76.2/89	100~240	106.4~246.5	17.5	31.8
M8	100	100~240	110~250	17.5	41.5

Packing

Capacitor diameter d(mm)	length l(mm)	Packing units (pcs.)
35	≤ 70 mm	120
	> 70 mm	60
42	≤ 70 mm	120
	> 70 mm	60
51	≤ 70 mm	70
	> 70 mm	35
63.5	all	24
76.2	all	15
89	all	12
100	all	6

Packing of screw

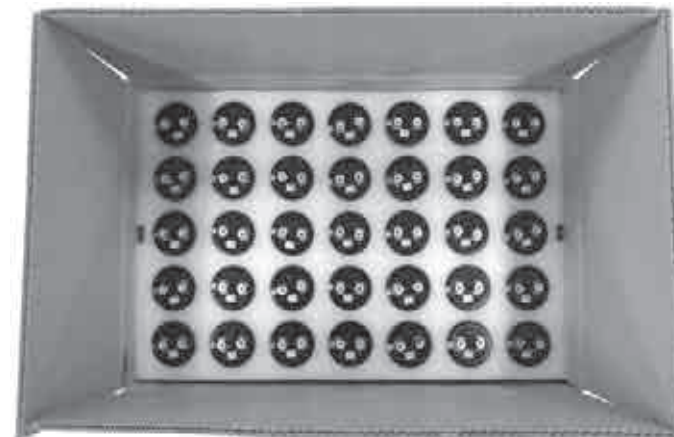

Accessories

The following items are included in the delivery package, but are not fastened to the capacitors.

	Thread	Maximum torque
For terminals	M5	2 Nm
	M6	2.5 Nm
	M8	5.0 Nm
For mounting	M12	10 Nm

Case Size

WV (Vdc)	Cap (uF)	Size (mm)	Rated Ripple current (Arms/85°C /120Hz)	Typ. ESR 20°C 120Hz (mΩ)	MAX ESR 20°C 120Hz (mΩ)
160	1000	35x60	2.8	110	200
160	1500	35x60	3.1	74	130
160	2200	35x80	4.2	52	90
160	2200	35x100	4.7	52	90
160	3300	35x100	5.3	34	60
160	3300	35x120	5.8	34	60
160	3900	51x75	5.5	29	51
160	3900	51x80	5.7	29	51
160	4700	51x75	5.9	24	42
160	4700	51x80	6.1	24	42
160	5600	51x96	7.2	20	36
160	6800	51x96	8.0	17	29
160	6800	51x100	8.1	17	29
160	6800	51x120	8.8	17	29
160	8200	51x115	9.3	14	24
160	8200	51x120	9.5	14	24
160	10000	51x140	10.9	11	20
160	10000	63.5x96	10.5	11	20
160	10000	63.5x100	10.7	11	20
160	12000	63.5x96	11.5	10	17
160	15000	63.5x120	14.0	8	13
160	15000	63.5x130	14.5	8	13
160	15000	76.2x100	14.6	8	13
160	18000	63.5x130	15.7	6	11
160	22000	76.2x120	17.6	5	9
160	22000	76.2x130	18.3	5	9
160	27000	76.2x130	20.3	4	7
160	33000	76.2x160	22.0	3	6
160	33000	89x130	23.8	3	6
160	33000	89x140	24.6	3	6
160	39000	89x157	28.0	3	6
160	47000	89x170	28.2	3	6
160	68000	89x230	28.5	3	5
200	1000	35x60	3.0	110	200
200	1500	35x80	3.5	74	130
200	2200	35x100	4.8	52	90
200	2700	35x120	5.5	42	74
200	3300	35x120	5.9	34	60
200	3300	51x75	6.0	34	60
200	3900	51x75	6.2	29	51
200	4700	51x96	6.4	24	42
200	4700	51x100	6.5	24	42
200	5600	51x115	7.6	20	36
200	6800	51x120	8.7	17	29
200	6800	51x130	9.0	17	29
200	8200	63.5x96	9.5	14	24
200	8200	63.5x100	9.7	14	24
200	10000	63.5x96	10.4	11	20
200	10000	63.5x120	11.5	11	20
200	12000	76.2x96	12.1	10	17
200	15000	76.2x96	14.6	8	13
200	15000	76.2x120	16.0	8	13
200	18000	76.2x130	16.6	6	11
200	22000	76.2x155	19.8	5	9
200	22000	89x120	19.3	5	9
200	27000	89x130	21.5	4	7
200	33000	89x157	25.6	3	6
200	47000	89x220	28.3	3	5
250	680	35x60	2.5	170	290
250	1000	35x80	3.1	110	200
250	1500	35x80	3.8	74	130

WV (Vdc)	Cap (uF)	Size (mm)	Rated Ripple current (Arms/85°C /120Hz)	Typ. ESR 20°C 120Hz (mΩ)	MAX ESR 20°C 120Hz (mΩ)
250	1800	35x100	3.9	63	110
250	2200	35x120	4.9	52	90
250	2200	51x75	4.8	52	90
250	2700	51x75	4.9	42	74
250	3300	51x96	6.1	34	60
250	3300	51x100	6.2	34	60
250	3900	51x115	6.5	29	51
250	4700	51x120	8.4	24	42
250	4700	51x140	9.1	24	42
250	4700	63.5x96	8.7	24	42
250	5600	63.5x96	9.3	20	36
250	6800	51x140	9.9	17	29
250	6800	63.5x115	10.2	17	29
250	6800	76.2x100	10.6	17	29
250	8200	63.5x115	10.9	14	24
250	10000	63.5x130	11.7	11	20
250	10000	76.2x120	12.5	11	20
250	10000	76.2x140	13.3	11	20
250	12000	76.2x115	12.8	10	17
250	15000	76.2x130	15.2	8	13
250	15000	76.2x150	16.2	8	13
250	15000	89x120	16.0	8	13
250	18000	76.2x155	17.8	6	11
250	22000	89x157	21.0	5	9
250	33000	89x220	25.7	3	6
250	47000	100x240	28.4	3	5
350	390	35x50	1.9	290	510
350	470	35x60	2.1	240	420
350	470	35x65	2.2	240	420
350	560	35x70	2.3	210	360
350	680	35x80	2.8	170	290
350	820	35x90	3.0	140	240
350	1000	35x100	3.6	110	200
350	1000	51x65	3.7	110	200
350	1200	35x120	3.9	97	170
350	1200	51x75	3.9	97	170
350	1500	51x60	4.4	74	130
350	1500	51x65	4.5	74	130
350	1500	51x75	4.8	74	130
350	1800	51x70	5.8	63	110
350	1800	51x75	6.0	63	110
350	1800	51x80	6.1	63	110
350	1800	51x85	6.3	63	110
350	2200	51x80	6.7	52	90
350	2200	51x96	7.3	52	90
350	2200	51x105	7.6	52	90
350	2200	51x120	8.0	52	90
350	2700	51x90	7.8	42	74
350	2700	51x105	8.4	42	74
350	2700	51x115	8.7	42	74
350	2700	63.5x65	7.7	42	74
350	2700	63.5x80	8.4	42	74
350	2700	63.5x96	9.1	42	74
350	3300	51x105	8.5	34	60
350	3300	51x120	9.1	34	60
350	3300	51x130	9.4	34	60
350	3300	63.5x75	8.4	34	60
350	3300	63.5x85	8.8	34	60
350	3300	63.5x96	9.3	34	60
350	3300	63.5x115	10.0	34	60
350	3900	51x130	11.3	29	51

WV (Vdc)	Cap (uF)	Size (mm)	Rated Ripple current (Arms/85°C /120Hz)	Typ. ESR 20°C 120Hz (mΩ)	MAX ESR 20°C 120Hz (mΩ)
350	3900	63.5x80	10.3	29	51
350	3900	63.5x96	11.1	29	51
350	3900	63.5x105	11.6	29	51
350	3900	63.5x115	12.0	29	51
350	3900	76.2x100	12.6	29	51
350	4700	51x140	12.9	24	42
350	4700	63.5x90	12.0	24	42
350	4700	63.5x115	13.3	24	42
350	4700	63.5x130	14.0	24	42
350	4700	76.2x70	12.0	24	42
350	4700	76.2x96	13.7	24	42
350	4700	76.2x100	13.8	24	42
350	5600	63.5x100	13.5	20	36
350	5600	63.5x130	15.2	20	36
350	5600	76.2x85	14.1	20	36
350	5600	76.2x96	14.8	20	36
350	5600	76.2x115	16.0	20	36
350	5600	76.2x125	16.5	20	36
350	5600	89x105	16.8	20	36
350	6800	63.5x125	15.9	17	29
350	6800	63.5x143	16.9	17	29
350	6800	76.2x95	15.7	17	29
350	6800	76.2x115	17.0	17	29
350	6800	76.2x130	17.9	17	29
350	6800	76.2x140	18.5	17	29
350	6800	89x100	17.5	17	29
350	8200	63.5x145	18.6	14	24
350	8200	76.2x105	17.9	14	24
350	8200	76.2x130	19.6	14	24
350	8200	76.2x143	20.4	14	24
350	8200	76.2x155	21.2	14	24
350	10000	63.5x165	21.8	11	20
350	10000	76.2x125	21.3	11	20
350	10000	76.2x155	23.4	11	20
350	10000	76.2x170	24.4	11	20
350	10000	76.2x190	25.6	11	20
350	10000	89x95	20.8	11	20
350	10000	89x120	22.9	11	20
350	10000	89x130	23.7	11	20
350	10000	89x157	25.7	11	20
350	12000	76.2x150	23.5	10	17
350	12000	76.2x180	25.5	10	17
350	12000	76.2x220	27.9	10	17
350	12000	89x110	22.5	10	17
350	12000	89x130	24.1	10	17
350	12000	89x145	25.3	10	17
350	12000	89x155	26.0	10	17
350	15000	76.2x190	29.2	8	13
350	15000	89x140	27.8	8	13
350	15000	89x155	29.1	8	13
350	15000	89x190	31.8	8	13
350	15000	89x219	34.0	8	13
350	18000	76.2x210	31.0	6	11
350	18000	89x155	29.5	6	11
350	18000	89x220	34.5	6	11
350	22000	89x190	32.1	5	9
350	22000	89x230	35.4	5	9
350	39000	100x240	42.0	3	5
400	330	35x50	1.8	340	600
400	390	35x60	2.0	290	510
400	390	35x65	2.1	290	510
400	470	35x70	2.2	240	420
400	560	35x80	2.8	210	360

WV (Vdc)	Cap (uF)	Size (mm)	Rated Ripple current (Arms/85°C /120Hz)	Typ. ESR 20°C 120Hz (mΩ)	MAX ESR 20°C 120Hz (mΩ)
400	680	35x90	2.9	170	290
400	820	35x100	3.5	140	240
400	1000	35x120	4.0	110	200
400	1000	51x60	3.6	110	200
400	1000	51x65	3.8	110	200
400	1000	51x75	4.0	110	200
400	1200	51x65	4.6	97	170
400	1200	51x75	4.9	97	170
400	1500	51x75	5.4	74	130
400	1500	51x80	5.6	74	130
400	1500	51x85	5.7	74	130
400	1500	51x100	6.1	74	130
400	1500	51x105	6.3	74	130
400	1800	51x85	6.3	63	110
400	1800	51x96	6.6	63	110
400	1800	63.5x65	6.4	63	110
400	2200	51x96	7.4	52	90
400	2200	51x105	7.7	52	90
400	2200	51x120	8.2	52	90
400	2200	51x130	8.5	52	90
400	2200	63.5x75	7.5	52	90
400	2200	63.5x96	8.4	52	90
400	2700	51x115	8.8	42	74
400	2700	63.5x85	8.7	42	74
400	2700	63.5x96	9.2	42	74
400	2700	63.5x105	9.6	42	74
400	3300	51x130	10.4	34	60
400	3300	51x145	10.9	34	60
400	3300	63.5x95	10.2	34	60
400	3300	63.5x100	10.4	34	60
400	3300	63.5x115	11.1	34	60
400	3300	63.5x120	11.3	34	60
400	3300	76.2x100	11.6	34	60
400	3900	51x170	12.8	29	51
400	3900	63.5x105	11.6	29	51
400	3900	63.5x115	12.1	29	51
400	3900	63.5x130	12.8	29	51
400	3900	76.2x85	11.8	29	51
400	3900	76.2x96	12.4	29	51
400	3900	76.2x105	12.9	29	51
400	4700	63.5x125	13.9	24	42
400	4700	63.5x130	14.1	24	42
400	4700	76.2x95	13.7	24	42
400	4700	76.2x100	14.0	24	42
400	4700	76.2x105	14.2	24	42
400	4700	76.2x115	14.8	24	42
400	4700	76.2x120	15.1	24	42
400	5600	63.5x140	15.8	20	36
400	5600	63.5x155	16.5	20	36
400	5600	76.2x105	16.7	20	36
400	5600	76.2x130	18.3	20	36
400	6800	63.5x165	17.5	17	29
400	6800	76.2x115	17.1	17	29
400	6800	76.2x130	17.4	17	29
400	6800	76.2x140	18.0	17	29
400	6800	76.2x155	18.8	17	29
400	6800	89x157	20.6	17	29
400	8200	63.5x210	22.2	14	24
400	8200	76.2x150	21.0	14	24
400	8200	76.2x155	21.3	14	24
400	8200	89x120	20.8	14	24
400	8200	89x130	21.5	14	24
400	8200	89x157	23.4	14	24

WV (Vdc)	Cap (uF)	Size (mm)	Rated Ripple current (Arms/85°C /120Hz)	Typ. ESR 20°C 120Hz (mΩ)	MAX ESR 20°C 120Hz (mΩ)
400	10000	76.2x160	23.9	11	20
400	10000	76.2x170	24.5	11	20
400	10000	76.2x190	25.8	11	20
400	10000	89x130	23.8	11	20
400	10000	89x155	25.7	11	20
400	12000	76.2x220	28.0	10	17
400	12000	89x155	26.1	10	17
400	12000	89x190	28.6	10	17
400	12000	89x219	30.5	10	17
400	15000	76.2x230	31.9	8	13
400	15000	89x180	31.1	8	13
400	15000	89x220	34.0	8	13
400	18000	89x230	34.6	6	11
400	22000	100x240	36.0	5	9
450	270	35x50	1.7	420	740
450	330	35x60	1.8	340	600
450	330	35x65	1.9	340	600
450	390	35x70	2.1	290	510
450	390	35x80	2.2	290	510
450	470	35x80	2.4	240	420
450	560	35x90	2.9	210	360
450	680	35x100	3.1	170	290
450	820	35x120	3.6	140	240
450	820	51x60	3.3	140	240
450	820	51x75	3.6	140	240
450	1000	51x70	4.3	110	200
450	1000	51x75	4.5	110	200
450	1000	51x80	4.6	110	200
450	1200	51x75	5.0	97	170
450	1200	51x96	5.6	97	170
450	1500	51x85	5.8	74	130
450	1500	51x105	6.4	74	130
450	1500	51x115	6.7	74	130
450	1500	51x120	6.8	74	130
450	1500	63.5x65	5.9	74	130
450	1500	63.5x80	6.4	74	130
450	1800	51x95	6.6	63	110
450	1800	51x118	7.3	63	110
450	1800	51x130	7.6	63	110
450	1800	63.5x75	6.8	63	110
450	1800	63.5x96	7.5	63	110
450	2200	51x125	8.4	52	90
450	2200	51x130	8.6	52	90
450	2200	63.5x85	8.1	52	90
450	2200	63.5x96	8.5	52	90
450	2200	63.5x100	8.6	52	90
450	2200	63.5x120	9.4	52	90
450	2700	51x145	9.9	42	74
450	2700	63.5x90	9.0	42	74
450	2700	63.5x96	9.3	42	74
450	2700	63.5x115	10.1	42	74
450	2700	76.2x96	10.3	42	74
450	3300	51x170	11.9	34	60
450	3300	63.5x105	10.8	34	60
450	3300	63.5x115	11.2	34	60
450	3300	63.5x130	11.8	34	60
450	3300	76.2x85	10.9	34	60
450	3300	76.2x96	11.5	34	60
450	3300	76.2x100	11.7	34	60
450	3300	76.2x120	12.6	34	60
450	3900	63.5x125	12.7	29	51
450	3900	63.5x130	12.9	29	51
450	3900	76.2x95	12.5	29	51

WV (Vdc)	Cap (uF)	Size (mm)	Rated Ripple current (Arms/85°C /120Hz)	Typ. ESR 20°C 120Hz (mΩ)	MAX ESR 20°C 120Hz (mΩ)
450	3900	76.2x100	12.8	29	51
450	3900	76.2x115	13.5	29	51
450	4700	63.5x145	14.9	24	42
450	4700	63.5x155	15.4	24	42
450	4700	76.2x105	14.4	24	42
450	4700	76.2x115	14.9	24	42
450	4700	76.2x120	15.2	24	42
450	4700	76.2x130	15.7	24	42
450	4700	76.2x160	17.2	24	42
450	4700	89x119	16.6	24	42
450	5600	63.5x165	18.5	20	36
450	5600	76.2x125	18.1	20	36
450	5600	76.2x130	18.4	20	36
450	5600	76.2x155	19.9	20	36
450	5600	89x134	20.4	20	36
450	6800	63.5x210	19.6	17	29
450	6800	76.2x140	18.0	17	29
450	6800	76.2x150	18.6	17	29
450	6800	89x120	18.4	17	29
450	6800	89x130	19.1	17	29
450	6800	89x157	20.7	17	29
450	8200	76.2x170	22.3	13	24
450	8200	76.2x220	25.0	13	24
450	8200	89x130	21.6	13	24
450	8200	89x155	23.4	13	24
450	10000	76.2x210	27.1	11	20
450	10000	76.2x215	27.4	11	20
450	10000	76.2x220	27.7	11	20
450	10000	89x155	25.8	11	20
450	10000	89x170	26.9	11	20
450	12000	89x190	28.7	10	17
450	12000	89x220	30.6	10	17
450	15000	89x220	34.1	8	13
500	120	35x50	0.8	1260	2210
500	270	35x80	1.3	560	980
500	330	35x100	1.5	460	800
500	390	35x120	1.8	390	680
500	470	51x60	2.2	320	560
500	470	51x75	2.4	320	560
500	680	51x65	2.8	220	390
500	680	51x96	3.3	220	390
500	820	51x75	3.2	180	320
500	820	51x115	3.9	180	320
500	1000	51x85	3.7	150	270
500	1000	51x130	4.5	150	270
500	1000	63.5x96	4.4	150	270
500	1200	51x96	4.3	130	220
500	1500	51x115	5.2	100	180
500	1500	63.5x96	5.4	100	180
500	1500	63.5x115	5.9	100	180
500	1500	76.2x96	6.0	100	180
500	1800	51x130	6.0	86	150
500	1800	63.5x96	5.9	86	150
500	1800	63.5x130	6.8	86	150
500	2200	63.5x115	7.1	69	120
500	2200	76.2x96	7.3	69	120
500	2200	76.2x115	7.9	69	120
500	2700	63.5x130	8.6	56	98
500	2700	76.2x155	10.3	56	98
500	3300	76.2x115	10.1	46	80
500	3900	76.2x130	11.5	39	68
500	3900	89x155	13.6	39	68
500	4700	76.2x155	13.4	32	56

WV (Vdc)	Cap (uF)	Size (mm)	Rated Ripple current (Arms/85°C /120Hz)	Typ. ESR 20°C 120Hz (mΩ)	MAX ESR 20°C 120Hz (mΩ)
500	5600	89x157	14.8	27	47
500	6800	89x155	16.0	22	39
500	8200	89x196	18.2	18	32
500	10000	89x220	22.3	15	27
550	100	35x50	0.7	1510	2650
550	180	35x80	1.1	840	1470
550	270	35x100	1.4	560	980
550	330	35x120	1.7	460	800
550	390	51x60	2.0	390	680
550	390	51x75	2.2	390	680
550	560	51x65	2.5	270	470
550	560	51x96	3.0	270	470
550	560	63.5x96	3.3	270	470
550	680	51x75	2.9	220	390
550	680	51x96	3.3	220	390
550	680	51x115	3.6	220	390
550	680	63.5x115	4.0	220	390
550	820	51x80	3.4	180	320
550	820	51x85	3.5	180	320
550	820	51x96	3.7	180	320
550	820	51x130	4.2	180	320
550	820	63.5x130	4.8	180	320
550	1000	51x96	4.9	150	270
550	1000	51x105	5.1	150	270
550	1200	51x105	5.8	130	220
550	1200	51x115	6.0	130	220
550	1200	63.5x80	5.8	130	220
550	1200	76.2x96	7.0	130	220
550	1500	51x130	7.4	100	180
550	1500	63.5x96	7.3	100	180
550	1500	76.2x115	8.8	100	180
550	1800	63.5x96	8.3	86	150
550	1800	63.5x118	9.1	86	150
550	1800	76.2x80	8.6	86	150
550	1800	76.2x96	9.2	86	150

WV (Vdc)	Cap (uF)	Size (mm)	Rated Ripple current (Arms/85°C /120Hz)	Typ. ESR 20°C 120Hz (mΩ)	MAX ESR 20°C 120Hz (mΩ)
550	1800	76.2x130	10.5	86	150
550	2200	63.5x118	9.4	69	120
550	2200	63.5x130	9.8	69	120
550	2200	76.2x96	9.5	69	120
550	2200	76.2x105	9.9	69	120
550	2200	76.2x155	11.7	69	120
550	2700	63.5x130	10.8	56	98
550	2700	76.2x105	10.9	56	98
550	2700	76.2x115	11.3	56	98
550	2700	76.2x130	12.0	56	98
550	3300	76.2x118	12.1	46	80
550	3300	76.2x130	12.6	46	80
550	3300	76.2x143	13.2	46	80
550	3900	76.2x143	14.2	39	68
550	3900	89x120	14.4	39	68
550	4700	76.2x155	16.2	32	56
550	4700	89x145	17.2	32	56
550	4700	89x157	17.8	32	56
550	5600	76.2x190	18.8	27	47
550	5600	89x145	18.2	27	47
550	5600	89x155	18.7	27	47
550	6800	76.2x220	21.8	22	39
550	6800	89x170	21.1	22	39
550	8200	89x197	25.3	18	32
630	1000	63.5x130	6.0	190	330
630	1200	76.2x110	6.8	160	280
630	1500	76.2x130	8.2	130	220
630	1800	76.2x150	9.7	100	180
630	2200	89x130	10.8	86	150
630	2700	89x150	12.7	69	120
630	3300	89x170	14.8	57	100
630	3900	89x190	17.4	49	85
630	4700	100x220	21.5	40	71
630	5600	100x240	24.8	34	59

Useful life

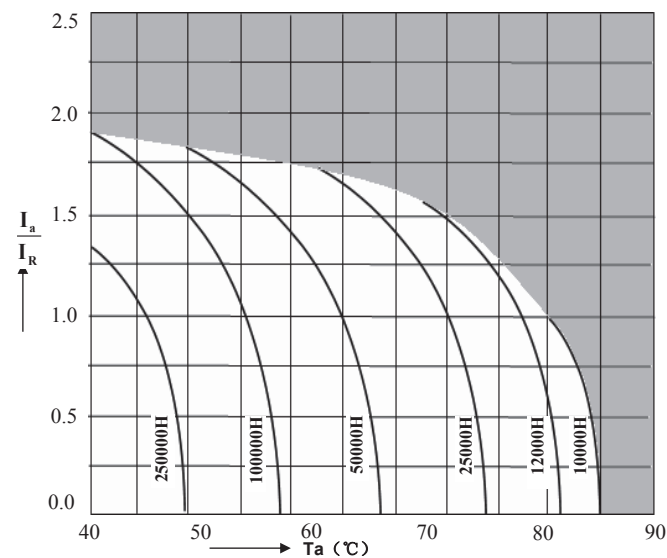

depending on ambient temperature T_a versus under ripple current operating conditions

RX Series 85°C

Features

Extremely Long useful life

Applications

- ◆ High reliability
- ◆ Professional power supplies
- ◆ Frequency converters
- ◆ Uninterruptible power supplies

Features

- ◆ Long useful life
- ◆ High reliability
- ◆ High reliability current capability
- ◆ Version with low-inductance design available
- ◆ All-welded construction ensures reliable electrical contact
- ◆ Self-extinguishing electrolyte
- ◆ RoHS-compatible

Construction

- ◆ Charge-discharge proof, polar
- ◆ Aluminum case with insulating sleeve
- ◆ Poles with screw terminal connections
- ◆ Mounting with ring clips, clamps or threaded stud



Specifications

Item	Performance Characteristics	
Operating Temperature Range	-40 to +85°C	-25 to +85°C
Rated voltage V_R	160 to 450 V DC	500 to 650 V DC
Surge voltage V_S	$V_R \leq 315V$ 1.15 V_R $V_R > 315V$ 1.10 V_R	
Rated capacitance C_R	200 to 100000 µF	10000 to 15000 µF
Capacitance tolerance	±20%(120Hz, +20°C)	
Leakage Current I_{leak} (+20°C, max.)	$I_{leak} = 0.018 \times (C \times V)^{0.85} + 4$ or 5mA, whichever is smaller (after 5 minutes) Where, I_{leak} : Max. leakage current (µA), C : Nominal capacitance (µF), V : Rated voltage (V)	
Dissipation Factor (tan δ, at 20°C, 120Hz)	Less than the value under table(%)	
	Working Voltage(VDC)	160~450 500~550 ≥ 600
	D.F. (%)max.	15 20 25
Self-inductance ESL	d = 51 mm: approx. 17 nH d ≥ 63.5 mm: approx. 20 nH Capacitors with low-inductance design: d ≥ 63.5 mm: approx. 15 nH	
Useful life 85°C; $V_R, I_{AC,R}$	>2000 h	Requirements: $\Delta C/C \leq \pm 15\%$ of initial value tan δ ≤ 1.75 times initial specified limit $I_{leak} \leq$ initial specified limit
Voltage Endurance test 85°C; V_R	2000 h	Post test requirements: $\Delta C/C \leq \pm 10\%$ of initial value tan δ ≤ 1.3 times initial specified limit $I_{leak} \leq$ initial specified limit
Vibration Resistance test	To IEC 60068-2-6, test Fc: Displacement amplitude 0.75 mm, frequency range 10 ... 55 Hz, acceleration max. 10 g, duration 3x2 h. Capacitor mounted by its body which is rigidly clamped to the work surface.	
Characteristics at low temperature	Max. impedance ratio at 120 Hz	
	$V_R(V)$	160-450 ≥ 500
	$Z_{-25^\circ C} / Z_{20^\circ C}$	4 4
	$Z_{-40^\circ C} / Z_{20^\circ C}$	10 -
Sectional specification	IEC 60384-4 and JIS-C-5101	

Screw

Multiplier for Ripple Current vs. Frequency

Frequency(Hz)	50	120	300	1K	≥3K
Multiplier	0.8	1	1.2	1.3	1.4

Dimensional drawings

Ring clip/clamp mounting:

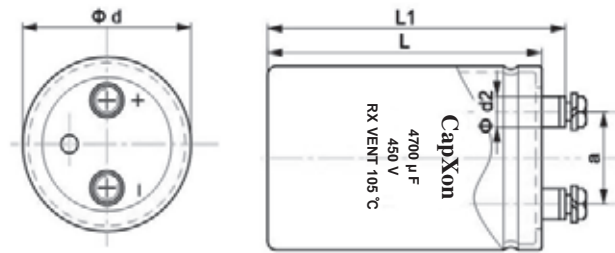

M5:Min.reach of screw = 8mm
 M6:Min.reach of screw = 12mm
 M8:Min.reach of screw = 16mm

Dimensions

Terminal	Dimensions(mm) with insulating sleeve				
	$d \pm 2$	$L \pm 3$	$L_1 \pm 3$	$d_2 \text{max.}$	$a \pm 0.5$
M5	35	50~120	56.5~126.5	10.3	12.7
M5	51	80~140	86.5~146.5	10.3	22
M5	63.5	80~140	86.5~146.5	10.3	28.6
M5	76.2/89	100~240	106.4~246.5	10.3	31.8
M6	76.2/89	100~240	106.4~246.5	17.5	31.8
M8	100	100~240	110~250	17.5	41.5

Packing

Capacitor diameter d(mm)	length l(mm)	Packing units (pcs.)
35	$\leq 70\text{mm}$	120
	$> 70\text{mm}$	60
42	$\leq 70\text{mm}$	120
	$> 70\text{mm}$	60
51	$\leq 70\text{mm}$	70
	$> 70\text{mm}$	35
63.5	all	24
76.2	all	15
89	all	12
100	all	6

Packing of screw



Accessories

The following items are included in the delivery package, but are not fastened to the capacitors.

	Thread	Maximum torque
For terminals	M5	2 Nm
	M6	2.5 Nm
	M8	5.0 Nm

Case Size

WV (Vdc)	Cap (uF)	Size (mm)	Rated Ripple current (Arms/85°C /120Hz)	Typ. ESR 20°C 120Hz (mΩ)	MAX ESR 20°C 120Hz (mΩ)
160	1000	35x60	2.5	110	200
160	1500	35x80	3.3	68	130
160	2200	35x80	3.5	48	90
160	2200	35x100	3.5	48	90
160	3300	35x120	4.7	32	60
160	3300	51x80	4.8	32	60
160	4700	51x80	5.1	22	42
160	4700	51x100	6.0	22	42
160	6800	51x100	6.4	15	29
160	6800	51x140	7.0	15	29
160	6800	63.5x100	7.0	15	29
160	10000	63.5x100	9.1	10	20
160	10000	63.5x120	10.0	10	20
160	15000	76.2x100	12.1	7	13
160	15000	76.2x120	13.0	7	13
160	22000	76.2x140	17.0	6.0	11
160	22000	89x130	18.0	6.0	11
160	33000	89x140	19.3	5.0	9
160	47000	89x170	20.7	4.0	7
160	47000	89x220	23.0	4.0	7
160	68000	89x220	23.2	3.5	6
160	100000	100x250	24.5	3.0	5
200	680	35x50	1.9	150	290
200	1000	35x60	2.6	110	200
200	1500	35x80	3.4	68	130
200	2200	35x100	3.6	48	90
200	2200	35x120	4.0	48	90
200	2200	51x80	4.0	48	90
200	3300	51x80	4.8	32	60
200	3300	51x100	5.0	32	60
200	4700	51x140	6.5	22	42
200	4700	63.5x100	6.5	22	42
200	6800	51x140	7.4	15	29
200	6800	63.5x120	8.0	15	29
200	10000	63.5x120	10.3	10	20
200	10000	76.2x120	13.1	10	20
200	15000	76.2x120	13.4	7	13
200	15000	76.2x140	15.0	7	13
200	15000	76.2x160	16.1	7	13
200	22000	76.2x160	17.4	6	9
200	22000	89x140	17.8	6	9
200	33000	89x170	19.6	4	7
200	47000	89x220	21.0	3	5.8
200	68000	100x250	22.7	3	5
250	470	35x60	2.7	220	420
250	680	35x80	2.8	150	290
250	1000	35x80	3.0	110	200
250	1000	35x100	3.3	110	200
250	1500	35x100	3.6	68	130
250	1500	51x80	3.7	68	130
250	2200	51x80	4.1	48	90
250	2200	51x100	5.5	48	90
250	3300	51x100	5.5	32	60
250	3300	51x140	6.0	32	60
250	3300	63.5x100	6.0	32	60
250	4700	63.5x100	7.4	22	42
250	4700	63.5x120	8.0	22	42
250	6800	63.5x120	9.0	15	29

WV (Vdc)	Cap (uF)	Size (mm)	Rated Ripple current (Arms/85°C /120Hz)	Typ. ESR 20°C 120Hz (mΩ)	MAX ESR 20°C 120Hz (mΩ)
250	6800	76.2x120	10.0	15	29
250	10000	76.2x120	13.3	10	20
250	10000	76.2x160	14.0	10	20
250	10000	89x140	14.0	10	20
250	15000	89x140	16.5	7	13
250	15000	89x170	18.0	7	13
250	22000	89x170	18.3	5	9
250	22000	89x220	22.4	5	9
250	33000	89x220	22.5	3	6
250	47000	100x250	28.5	3	5
350	330	35x60	2.1	320	600
350	470	35x80	3.0	220	420
350	680	35x100	3.8	150	290
350	820	35x80	4.1	130	240
350	1000	35x100	4.5	110	200
350	1000	51x60	4.0	110	200
350	1000	51x80	5.7	110	200
350	1200	51x60	5.0	89	170
350	1200	51x83	5.8	89	170
350	1500	51x75	6.0	68	130
350	1500	51x100	7.0	68	130
350	1800	51x75	6.8	58	110
350	1800	51x90	7.4	58	110
350	1800	63.5x96	8.5	58	110
350	2200	51x105	8.5	48	90
350	2200	51x120	9.0	48	90
350	2700	51x105	9.4	39	74
350	2700	51x115	10.6	39	74
350	2700	63.5x80	9.8	39	74
350	2700	63.5x85	10.1	39	74
350	3300	51x115	10.8	32	60
350	3300	51x130	12.5	32	60
350	3300	63.5x90	12.0	32	60
350	3300	63.5x100	12.5	32	60
350	3900	63.5x100	13.0	27	51
350	3900	63.5x115	13.9	27	51
350	3900	76.2x80	13.0	27	51
350	4700	63.5x105	14.0	22	42
350	4700	63.5x115	14.5	22	42
350	4700	76.2x90	14.0	22	42
350	4700	76.2x120	16.0	22	42
350	5600	63.5x130	17.4	19	36
350	5600	63.5x150	19.0	19	36
350	5600	76.2x100	16.8	19	36
350	5600	76.2x115	18.0	19	36
350	6800	63.5x140	19.0	15	29
350	6800	63.5x155	19.6	15	29
350	6800	76.2x105	19.0	15	29
350	6800	76.2x115	20.0	15	29
350	6800	89x100	20.0	15	29
350	8200	63.5x170	20.7	13	24
350	8200	63.5x190	22.0	13	24
350	8200	76.2x120	20.0	13	24
350	8200	76.2x143	21.0	13	24
350	8200	76.2x155	22.5	13	24
350	8200	89x105	20.0	13	24
350	8200	89x120	22.0	13	24
350	10000	76.2x140	24.0	10	20

WV (Vdc)	Cap (uF)	Size (mm)	Rated Ripple current (Arms/85°C /120Hz)	Typ. ESR 20°C 120Hz (mΩ)	MAX ESR 20°C 120Hz (mΩ)
350	10000	76.2x155	25.0	10	20
350	10000	89x130	27.0	10	20
350	10000	89x155	29.0	10	20
350	12000	76.2x170	27.6	9	17
350	12000	89x130	27.5	9	17
350	12000	89x155	29.5	9	17
350	12000	89x170	31.0	9	17
350	15000	76.2x220	35.4	7	13
350	15000	89x155	33.8	7	13
350	15000	89x170	35.1	7	13
350	15000	89x190	36.0	7	13
350	18000	89x180	43.8	6	11
350	18000	89x220	44.6	6	11
350	18000	100x190	48.0	6	11
350	22000	89x220	46.7	5	9
350	22000	100x250	48.0	5	9
400	220	35x50	1.9	470	900
400	330	35x60	2.3	320	600
400	470	35x80	4.4	220	420
400	680	35x80	4.5	150	290
400	680	35x120	5.0	150	290
400	680	51x80	6.0	150	290
400	820	35x100	4.7	130	240
400	1000	51x60	4.8	110	200
400	1000	51x80	6.2	110	200
400	1200	51x70	5.0	89	170
400	1200	51x83	6.5	89	170
400	1500	51x80	6.4	68	130
400	1500	51x95	7.0	68	130
400	1500	63.5x95	8.0	68	130
400	1800	51x85	7.0	58	110
400	1800	51x95	7.4	58	110
400	2200	51x105	8.8	48	90
400	2200	51x115	10.0	48	90
400	2200	63.5x85	10.1	48	90
400	2200	63.5x100	11.5	48	90
400	2200	76.2x105	12.5	48	90
400	2700	51x115	10.8	39	74
400	2700	51x130	11.0	39	74
400	2700	63.5x90	11.0	39	74
400	2700	63.5x105	12.0	39	74
400	2700	76.2x75	11.6	39	74
400	3300	51x130	12.8	32	60
400	3300	51x150	14.0	32	60
400	3300	63.5x95	13.0	32	60
400	3300	63.5x115	14.0	32	60
400	3300	76.2x90	14.0	32	60
400	3300	76.2x105	14.3	32	60
400	3300	76.2x120	15.0	32	60
400	3900	63.5x100	14.2	27	51
400	3900	63.5x115	15.2	27	51
400	3900	76.2x90	15.1	27	51
400	3900	76.2x120	16.5	27	51
400	4700	63.5x120	16.0	22	42
400	4700	63.5x155	17.5	22	42
400	4700	76.2x105	15.5	22	42
400	5600	63.5x145	18.0	19	36
400	5600	63.5x155	18.2	19	36
400	5600	63.5x170	19.0	19	36
400	5600	76.2x105	17.0	19	36

WV (Vdc)	Cap (uF)	Size (mm)	Rated Ripple current (Arms/85°C /120Hz)	Typ. ESR 20°C 120Hz (mΩ)	MAX ESR 20°C 120Hz (mΩ)
400	5600	76.2x130	19.0	19	36
400	5600	89x92	18.0	19	36
400	6800	63.5x160	23.5	15	29
400	6800	63.5x190	24.2	15	29
400	6800	76.2x130	19.2	15	29
400	6800	76.2x150	21.5	15	29
400	6800	89x105	21.2	15	29
400	6800	89x120	22.3	15	29
400	8200	76.2x135	24.0	13	24
400	8200	76.2x155	25.0	13	24
400	8200	76.2x170	26.2	13	24
400	8200	89x120	25.0	13	24
400	8200	89x140	26.0	13	24
400	10000	76.2x160	31.6	10	20
400	10000	76.2x180	33.0	10	20
400	10000	89x130	31.0	10	20
400	10000	89x155	34.0	10	20
400	12000	76.2x220	34.0	9	17
400	12000	89x155	30.0	9	17
400	12000	89x170	31.3	9	17
400	15000	89x180	39.9	7	13
400	15000	89x200	40.7	7	13
400	18000	89x210	43.0	6	11
400	18000	89x240	45.0	6	11
400	22000	100x240	47.0	5	9
420	820	51x60	3.8	130	240
420	1000	51x70	5.1	110	200
420	1200	51x80	6.6	89	170
420	1800	51x95	7.6	58	110
420	1800	51x105	8.0	58	110
420	2200	51x115	10.1	48	90
420	2700	51x120	11.0	39	74
420	2700	63.5x90	11.0	39	74
420	3300	51x130	13.0	32	60
420	3300	63.5x105	13.5	32	60
420	3300	76.2x105	14.6	32	60
420	3900	63.5x115	15.8	27	51
420	3900	63.5x130	16.4	27	51
420	3900	76.2x90	15.5	27	51
420	4700	63.5x143	17.0	22	42
420	4700	63.5x155	17.8	22	42
420	4700	76.2x105	15.7	22	42
420	4700	76.2x143	17.5	22	42
420	5600	63.5x170	19.2	19	36
420	5600	76.2x115	17.5	19	36
420	5600	76.2x130	19.2	19	36
420	5600	89x90	18.1	19	36
420	6800	76.2x143	21.1	15	29
420	6800	76.2x155	22.0	15	29
420	6800	89x105	19.9	15	29
420	6800	89x115	20.5	15	29
420	8200	76.2x170	27.1	13	24
420	8200	89x115	25.0	13	24
420	8200	89x130	26.2	13	24
420	10000	76.2x180	34.0	10	20
420	10000	76.2x220	37.0	10	20
420	10000	89x143	33.0	10	20
420	10000	89x155	35.0	10	20
420	12000	76.2x220	35.0	9	17
420	12000	89x155	31.1	9	17

WV (Vdc)	Cap (uF)	Size (mm)	Rated Ripple current (Arms/85°C /120Hz)	Typ. ESR 20°C 120Hz (mΩ)	MAX ESR 20°C 120Hz (mΩ)
420	12000	89x170	31.7	9	17
420	15000	89x190	40.1	7	13
420	18000	89x220	43.3	6	11
450	220	35x50	2.0	470	900
450	330	35x60	2.5	320	600
450	470	35x80	4.5	220	420
450	470	51x75	4.5	220	420
450	680	35x100	4.6	150	290
450	680	35x120	5.2	150	290
450	680	51x80	6.2	150	290
450	820	35x110	6.4	130	240
450	820	51x60	6.0	130	240
450	1000	51x70	6.3	110	200
450	1000	51x80	6.5	110	200
450	1200	51x80	7.0	89	170
450	1200	51x95	7.3	89	170
450	1200	63.5x95	8.3	89	170
450	1500	51x95	7.5	68	130
450	1500	51x115	7.8	68	130
450	1800	51x105	8.2	58	110
450	1800	51x115	8.4	58	110
450	1800	63.5x80	8.0	58	110
450	1800	63.5x105	8.5	58	110
450	2200	51x115	10.2	48	90
450	2200	51x130	11.0	48	90
450	2200	63.5x90	10.0	48	90
450	2200	63.5x120	12.1	48	90
450	2200	76.2x85	11.0	48	90
450	2700	51x115	11.2	39	74
450	2700	51x130	12.0	39	74
450	2700	63.5x95	12.0	39	74
450	2700	63.5x115	13.0	39	74
450	2700	76.2x80	12.0	39	74
450	2700	76.2x130	14.8	39	74
450	3300	63.5x105	13.6	32	60
450	3300	63.5x115	14.0	32	60
450	3300	76.2x100	15.0	32	60
450	3300	76.2x120	16.0	32	60
450	3900	63.5x125	16.0	27	51
450	3900	63.5x150	16.6	27	51
450	3900	76.2x90	15.0	27	51
450	3900	76.2x115	17.0	27	51
450	3900	89x90	17.0	27	51
450	4700	63.5x145	18.7	22	42
450	4700	63.5x170	20.0	22	42
450	4700	76.2x105	18.0	22	42
450	4700	76.2x130	20.0	22	42
450	4700	89x110	20.0	22	42
450	5600	63.5x165	21.7	19	36
450	5600	63.5x190	23.2	19	36
450	5600	76.2x115	20.5	19	36
450	5600	76.2x130	21.6	19	36
450	5600	89x90	20.2	19	36
450	5600	89x120	22.8	19	36
450	6800	89x105	22.8	15	29
450	6800	89x130	25.0	15	29
450	8200	76.2x165	27.0	13	24
450	8200	76.2x180	30.0	13	24
450	8200	89x130	29.0	13	24
450	8200	89x155	31.0	13	24

WV (Vdc)	Cap (uF)	Size (mm)	Rated Ripple current (Arms/85°C /120Hz)	Typ. ESR 20°C 120Hz (mΩ)	MAX ESR 20°C 120Hz (mΩ)
450	10000	76.2x220	37.5	10	20
450	10000	89x155	36.1	10	20
450	10000	89x170	37.6	10	20
450	12000	76.2x220	39.1	9	17
450	12000	89x155	36.4	9	17
450	12000	89x190	39.9	9	17
450	12000	100x190	42.5	9	17
450	15000	89x220	43.5	7	13
450	15000	89x240	45.3	7	13
450	15000	100x195	43.9	7	13
450	18000	100x237	48.0	6	11
450	22000	89x236	48.0	5	9
500	1000	51x95	5.6	140	270
500	1000	51x110	6.0	140	270
500	1000	63.5x80	6.0	140	270
500	1200	51x95	7.1	120	220
500	1200	51x115	8.0	120	220
500	1200	63.5x85	8.1	120	220
500	1500	51x100	7.2	95	180
500	1500	51x115	7.5	95	180
500	1500	63.5x90	7.5	95	180
500	1500	63.5x105	7.8	95	180
500	1800	51x130	8.3	79	150
500	1800	63.5x90	8.2	79	150
500	1800	63.5x115	8.6	79	150
500	2200	51x143	12.1	63	120
500	2200	51x150	12.5	63	120
500	2200	63.5x105	11.5	63	120
500	2200	63.5x115	12.2	63	120
500	2700	63.5x115	13.2	52	98
500	2700	63.5x143	13.8	52	98
500	2700	76.2x90	12.2	52	98
500	2700	76.2x110	13.1	52	98
500	3300	63.5x130	14.3	42	80
500	3300	63.5x150	15.1	42	80
500	3300	76.2x105	15.1	42	80
500	3300	76.2x115	16.0	42	80
500	3900	63.5x170	17.2	36	68
500	3900	76.2x115	17.5	36	68
500	3900	76.2x130	18.2	36	68
500	3900	89x90	17.8	36	68
500	3900	89x120	19.5	36	68
500	4700	76.2x135	20.5	30	56
500	4700	76.2x150	21.8	30	56
500	4700	89x105	20.0	30	56
500	4700	89x130	22.0	30	56
500	5600	76.2x143	20.0	25	47
500	5600	76.2x170	20.8	25	47
500	5600	89x115	18.2	25	47
500	5600	89x130	19.5	25	47
500	6800	76.2x180	31.0	21	39
500	6800	76.2x190	31.5	21	39
500	6800	89x143	30.6	21	39
500	6800	89x170	31.8	21	39
500	8200	76.2x220	31.8	17	32
500	8200	89x155	32.0	17	32
500	8200	89x175	33.0	17	32
500	8200	100x175	34.1	17	32
500	10000	89x190	38.3	14	27
500	10000	89x220	39.5	14	27

WV (Vdc)	Cap (uF)	Size (mm)	Rated Ripple current (Arms/85°C /120Hz)	Typ. ESR 20°C 120Hz (mΩ)	MAX ESR 20°C 120Hz (mΩ)
500	10000	100x190	41.5	14	27
500	12000	89x220	39.1	12	22
500	12000	89x240	40.5	12	22
500	12000	100x210	41.6	12	22
500	12000	100x240	42.4	12	22
500	15000	100x250	43.5	9	18
550	1200	51x110	6.4	120	220
550	1200	63.5x110	8.0	120	220
550	1500	51x130	7.7	95	180
550	1500	63.5x130	9.0	95	180
550	1800	63.5x105	8.7	79	150
550	1800	63.5x120	9.0	79	150
550	1800	76.2x110	10.0	79	150
550	2200	63.5x120	10.3	63	120
550	2200	76.2x130	13.0	63	120
550	2700	63.5x150	12.5	52	98
550	2700	76.2x105	12.3	52	98
550	2700	76.2x155	16.0	52	98
550	3300	63.5x170	15.2	42	80
550	3300	76.2x130	15.6	42	80
550	3300	76.2x155	17.0	42	80
550	3900	76.2x140	18.4	36	68
550	3900	89x150	21.0	36	68
550	4700	76.2x170	22.2	30	56
550	4700	89x130	23.2	30	56
550	4700	89x170	25.0	30	56
550	5600	76.2x190	25.0	25	47
550	5600	89x150	24.5	25	47
550	5600	89x190	27.2	25	47
550	6800	89x170	27.5	21	39

WV (Vdc)	Cap (uF)	Size (mm)	Rated Ripple current (Arms/85°C /120Hz)	Typ. ESR 20°C 120Hz (mΩ)	MAX ESR 20°C 120Hz (mΩ)
550	6800	89x190	28.9	21	39
550	8200	89x220	36.5	17	32
550	8200	100x170	35.0	17	32
550	8200	100x220	40.0	17	32
550	10000	89x240	42.5	14	27
550	10000	100x200	42.4	14	27
550	10000	100x250	43.0	14	27
600	1200	63.5x95	7.0	150	280
600	1500	63.5x110	8.4	120	220
600	1800	63.5x125	9.7	95	180
600	1800	76.2x95	9.5	95	180
600	2200	63.5x145	11.4	79	150
600	2200	76.2x110	11.2	79	150
600	2700	63.5x170	13.5	63	120
600	2700	76.2x125	13.2	63	120
600	3300	76.2x145	15.5	53	100
600	3900	76.2x170	21.1	45	85
600	3900	89x130	19.8	45	85
600	4700	76.2x190	22.5	37	71
600	4700	89x150	24.0	37	71
600	5600	89x170	26.0	31	59
650	1000	63.5x100	7.2	170	330
650	1200	63.5x110	8.0	150	280
650	1500	63.5x130	9.2	120	220
650	1800	63.5x150	10.5	95	180
650	2200	63.5x170	12.3	79	150
650	2700	76.2x150	14.5	63	120
650	3300	76.2x170	16.8	53	100
650	3900	89x155	22.0	45	85
650	4700	89x190	28.0	37	71

Useful life

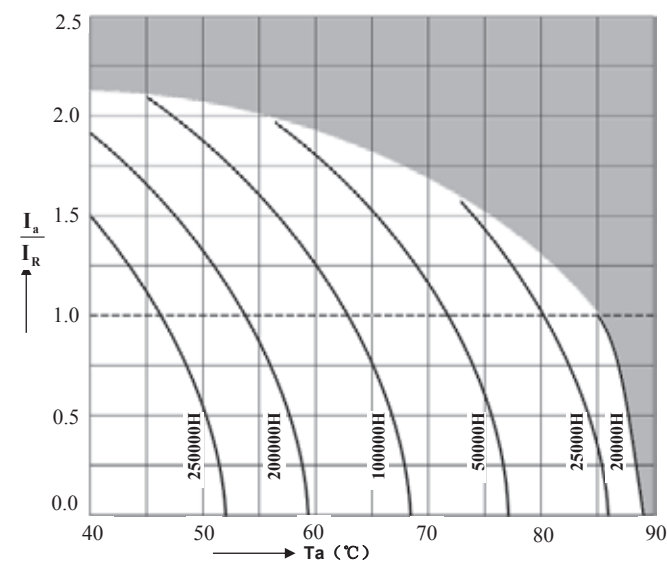

depending on ambient temperature T_a versus under ripple current operating conditions

RU Series 105°C

Features

Extremely Long useful life

Applications

- ◆ High reliability
- ◆ Professional power supplies
- ◆ Frequency converters
- ◆ Uninterruptible power supplies

Features

- ◆ Long useful life
- ◆ High reliability
- ◆ High reliability current capability
- ◆ Version with low-inductance design available
- ◆ All-welded construction ensures reliable electrical contact
- ◆ Self-extinguishing electrolyte
- ◆ RoHS-compatible

Construction

- ◆ Charge-discharge proof, polar
- ◆ Aluminum case with insulating sleeve
- ◆ Poles with screw terminal connections
- ◆ Mounting with ring clips, clamps or threaded stud



Specifications

Item	Performance Characteristics		
Operating Temperature Range	-40 to +85°C		-25 to +85°C
Rated voltage V_R	160 to 450 V DC		500 V DC
Surge voltage V_S	$V_R \leq 315V$ 1.15 V_R $V_R > 315V$ 1.10 V_R		
Rated capacitance C_R	1000 to 33000 μF		820 to 10000 μF
Capacitance tolerance	$\pm 20\%$ (120Hz, +20°C)		
Leakage Current I_{leak} (+20°C, max.)	$I_{leak} = 0.018 \times (C \times V)^{0.85} + 4$ or 5mA, whichever is smaller (after 5 minutes) Where, I_{leak} : Max. leakage current (μA), C : Nominal capacitance (μF), V : Rated voltage (V)		
Dissipation Factor (tan δ , at 20°C, 120Hz)	Less than the value under table(%)		
	Working Voltage(VDC)	160~450	500~550 ≥ 600
Self-inductance ESL	d = 51 mm: approx. 17 nH		
	d ≥ 63.5 mm: approx. 20 nH		
	Capacitors with low-inductance design: d ≥ 63.5 mm: approx. 15 nH		
Useful life 85°C; $V_R, I_{AC,R}$	>12000 h	Requirements:	
		$\Delta C/C$	$\leq \pm 15\%$ of initial value
Voltage Endurance test 85°C; V_R	2000 h	Post test requirements:	
		$\Delta C/C$	$\leq \pm 10\%$ of initial value
		tan δ	≤ 1.3 times initial specified limit
Vibration Resistance test	To IEC 60068-2-6, test Fc:		
	Displacement amplitude 0.75 mm, frequency range 10 ... 55 Hz, acceleration max. 10 g, duration 3x2 h. Capacitor mounted by its body which is rigidly clamped to the work surface.		
Characteristics at low temperature	Max. impedance ratio at 120 Hz		
	$V_R(V)$	160-450	≥ 500
	$Z_{-25^\circ C} / Z_{20^\circ C}$	4	4
Sectional specification	$Z_{-40^\circ C} / Z_{20^\circ C}$	10	-
	IEC 60384-4 and JIS-C-5101		

Screw

Multiplier for Ripple Current vs. Frequency

Frequency(Hz)	50	120	300	1K	$\geq 3K$
Multiplier	0.8	1	1.2	1.3	1.4

Dimensional drawings

Ring clip/clamp mounting:

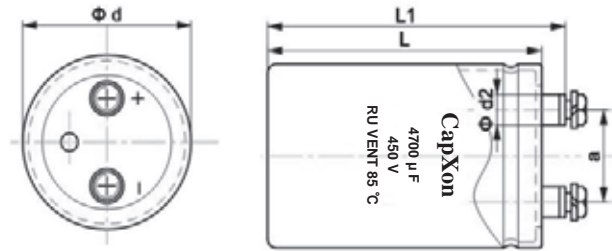

M5:Min.reach of screw = 8mm
 M6:Min.reach of screw = 12mm
 M8:Min.reach of screw = 16mm

Dimensions

Terminal	Dimensions(mm) with insulating sleeve				
	$d \pm 2$	$L \pm 3$	$L_1 \pm 3$	$d_2 \text{max.}$	$a \pm 0.5$
M5	35	50~120	56.5~126.5	10.3	12.7
M5	51	80~140	86.5~146.5	10.3	22
M5	63.5	80~140	86.5~146.5	10.3	28.6
M5	76.2/89	100~240	106.4~246.5	10.3	31.8
M6	76.2/89	100~240	106.4~246.5	17.5	31.8
M8	100	100~240	110~250	17.5	41.5

Packing

Capacitor diameter d(mm)	length l(mm)	Packing units (pcs.)
35	≤ 70 mm	120
	> 70 mm	60
42	≤ 70 mm	120
	> 70 mm	60
51	≤ 70 mm	70
	> 70 mm	35
63.5	all	24
76.2	all	15
89	all	12
100	all	6

Packing of screw



Accessories

The following items are included in the delivery package, but are not fastened to the capacitors.

	Thread	Maximum torque
For terminals	M5	2 Nm
	M6	2.5 Nm
	M8	5.0 Nm
For mounting	M12	10 Nm

Case Size

WV (Vdc)	Cap (uF)	Size (mm)	Rated Ripple current (Arms/85°C /120Hz)	Typ. ESR 20°C 120Hz (mΩ)	MAX ESR 20°C 120Hz (mΩ)
200	3300	51x80	8.6	33	60
200	3900	51x95	9.8	28	51
200	4700	51x105	11.3	24	42
200	4700	63.5x80	11.4	24	42
200	5600	51x115	12.4	20	36
200	5600	63.5x95	12.9	20	36
200	6800	63.5x95	14.0	16	29
200	8200	63.5x115	17.6	13	24
200	8200	76.2x95	18.0	13	24
200	10000	63.5x130	19.8	11	20
200	10000	76.2x105	20.0	11	20
200	12000	76.2x115	22.3	9	17
200	15000	76.2x140	27.8	7	13
200	15000	89x120	28.4	7	13
200	18000	76.2x155	30.5	6	11
200	18000	89x140	31.8	6	11
200	22000	76.2x190	34.6	5	9
200	22000	89x170	35.9	5	9
200	27000	76.2x220	39.4	4	7
200	27000	89x195	40.6	4	7
200	33000	89x220	45.9	3	6
250	2700	51x80	7.3	41	74
250	3300	51x80	8.9	33	60
250	3900	51x105	9.9	28	51
250	3900	63.5x80	10.0	28	51
250	4700	51x130	11.6	24	42
250	4700	63.5x95	11.7	24	42
250	5600	63.5x95	12.3	20	36
250	6800	63.5x115	15.4	16	29
250	6800	76.2x95	15.8	16	29
250	8200	63.5x130	17.4	13	24
250	8200	76.2x105	17.6	13	24
250	10000	76.2x115	20.2	11	20
250	10000	89x120	22.5	11	20
250	12000	76.2x140	24.2	9	17
250	12000	89x120	24.7	9	17
250	15000	76.2x160	27.5	7	13
250	15000	89x140	28.3	7	13
250	18000	76.2x190	30.6	6	11
250	18000	89x170	31.7	6	11
250	22000	76.2x220	34.8	5	9
250	22000	89x195	35.9	5	9
250	27000	89x220	40.8	4	7
350	1500	51x80	6.4	72	130
350	1800	51x80	9.5	61	110
350	2200	51x80	9.7	50	90
350	2200	51x95	10.8	50	90
350	2200	63.5x80	11.3	50	90
350	2700	51x95	12.0	41	74
350	2700	63.5x80	12.6	41	74
350	3300	51x115	14.3	33	60
350	3300	63.5x90	14.5	33	60
350	3900	51x130	16.2	28	51
350	3900	63.5x95	16.3	28	51
350	3900	63.5x105	16.6	28	51
350	4700	63.5x105	17.9	24	42
350	4700	76.2x95	19.3	24	42
350	5600	63.5x120	19.4	20	36

WV (Vdc)	Cap (uF)	Size (mm)	Rated Ripple current (Arms/85°C /120Hz)	Typ. ESR 20°C 120Hz (mΩ)	MAX ESR 20°C 120Hz (mΩ)
350	5600	76.2x95	20.2	20	36
350	6800	63.5x140	23.2	16	29
350	6800	76.2x105	23.1	16	29
350	6800	89x100	25.0	16	29
350	8200	76.2x115	25.1	13	24
350	8200	89x120	29.6	13	24
350	10000	76.2x140	32.1	11	20
350	10000	89x120	33.2	11	20
350	12000	76.2x170	35.3	9	17
350	12000	89x140	37.3	9	17
350	15000	76.2x190	41.0	7	13
350	15000	89x160	41.9	7	13
350	18000	89x195	48.1	6	11
350	22000	89x220	50.5	5	9
400	1000	51x80	4.6	110	200
400	1500	51x80	7.0	72	130
400	1800	51x95	10.0	61	110
400	2200	51x100	11.2	50	90
400	2200	63.5x80	11.6	50	90
400	2700	51x115	13.2	41	74
400	2700	63.5x95	13.9	41	74
400	3300	51x130	14.6	33	60
400	3300	63.5x105	15.0	33	60
400	3900	63.5x105	16.1	28	51
400	3900	76.2x95	18.3	28	51
400	4700	63.5x130	20.2	24	42
400	4700	76.2x95	20.0	24	42
400	5600	63.5x140	21.5	20	36
400	5600	76.2x115	21.8	20	36
400	6800	76.2x130	25.2	16	29
400	6800	89x120	27.3	16	29
400	8200	76.2x155	29.2	13	24
400	8200	89x120	29.1	13	24
400	10000	76.2x165	32.5	11	20
400	10000	89x140	34.7	11	20
400	12000	76.2x220	39.5	8	17
400	12000	89x160	38.0	8	17
400	15000	76.2x230	42.1	7	13
400	15000	89x180	41.6	7	13
400	18000	89x220	46.4	6	11
450	1200	51x80	7.1	94	170
450	1500	51x80	7.8	72	130
450	1800	51x105	9.6	61	110
450	1800	63.5x80	9.8	61	110
450	2200	51x115	11.0	50	90
450	2200	63.5x95	11.4	50	90
450	2700	63.5x95	12.6	41	74
450	2700	76.2x95	14.2	41	74
450	3300	63.5x115	14.4	33	60
450	3300	76.2x95	15.0	33	60
450	3900	63.5x130	16.2	28	51
450	3900	76.2x105	16.3	28	51
450	4700	76.2x115	20.4	24	42
450	5600	76.2x130	22.9	20	36
450	5600	89x120	24.2	20	36
450	6800	76.2x155	27.3	16	29
450	8200	76.2x190	29.6	13	24
450	8200	89x170	30.7	13	24

WV (Vdc)	Cap (uF)	Size (mm)	Rated Ripple current (Arms/85°C /120Hz)	Typ. ESR 20°C 120Hz (mΩ)	MAX ESR 20°C 120Hz (mΩ)
450	10000	76.2x220	32.6	11	20
450	10000	89x170	33.4	11	20
450	12000	89x195	37.7	9	17
500	820	51x80	5.1	180	320
500	1000	51x95	5.8	150	270
500	1200	51x95	6.6	120	220
500	1200	63.5x80	7.0	120	220
500	1500	51x115	7.7	100	180
500	1500	63.5x80	7.8	100	180
500	1800	51x130	8.8	83	150
500	1800	63.5x95	8.8	83	150
500	2200	63.5x105	10.0	67	120
500	2700	63.5x115	11.5	55	98

WV (Vdc)	Cap (uF)	Size (mm)	Rated Ripple current (Arms/85°C /120Hz)	Typ. ESR 20°C 120Hz (mΩ)	MAX ESR 20°C 120Hz (mΩ)
500	2700	76.2x95	11.9	55	98
500	3300	63.5x140	13.2	45	80
500	3300	76.2x115	13.5	45	80
500	3900	76.2x130	15.1	38	68
500	4700	76.2x120	18.7	31	56
500	5600	76.2x165	19.9	26	47
500	5600	89x140	20.8	26	47
500	6800	76.2x190	22.8	22	39
500	6800	89x170	23.5	22	39
500	8200	76.2x220	26.2	18	32
500	8200	89x195	26.6	18	32
500	10000	89x220	30.4	15	27

Useful life

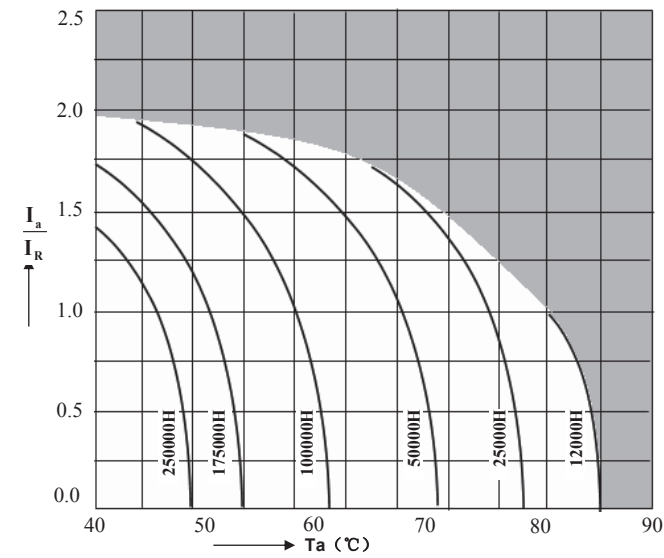

depending on ambient temperature T_a versus under ripple current operating conditions

RJ Series 85°C

Features

Long useful life

Applications

- ◆ Professional power supplies
- ◆ Frequency converters
- ◆ Uninterruptible power supplies

Features

- ◆ Long useful life
- ◆ High reliability
- ◆ Version with low-inductance design available
- ◆ All-welded construction ensures reliable electrical contact
- ◆ Self-extinguishing electrolyte
- ◆ RoHS-compatible

Construction

- ◆ Charge-discharge proof, polar
- ◆ Aluminum case with insulating sleeve
- ◆ Poles with screw terminal connections
- ◆ Mounting with ring clips, clamps or threaded stud



Specifications

Item	Performance Characteristics						
Operating Temperature Range	-40 to +85°C						
Rated voltage V_R	350 to 450 V DC						
Surge voltage V_S	$V_R \leq 315V$ 1.15 V_R $V_R > 315V$ 1.10 V_R						
Rated capacitance C_R	150 to 22000 μF						
Capacitance tolerance	$\pm 20\%$ (120Hz, +20°C)						
Leakage Current I_{leak} (+20°C, max.)	$I_{leak} = 0.018 \times (C \times V)^{0.85} + 4$ or 5mA, whichever is smaller (after 5 minutes) Where, I_{leak} : Max. leakage current (μA), C : Nominal capacitance (μF), V : Rated voltage (V)						
Dissipation Factor ($\tan \delta$, at 20°C, 120Hz)	Less than the value under table(%)						
	<table border="1"> <tr> <td>Working Voltage(VDC)</td> <td>350~450</td> </tr> <tr> <td>D.F. (%)max.</td> <td>15</td> </tr> </table>	Working Voltage(VDC)	350~450	D.F. (%)max.	15		
Working Voltage(VDC)	350~450						
D.F. (%)max.	15						
Self-inductance ESL	d = 51 mm: approx. 17 nH d \geq 63.5 mm: approx. 20 nH						
	Capacitors with low-inductance design: d \geq 63.5 mm: approx. 15 nH						
Useful life 85°C; $V_R, I_{AC, R}$	Requirements:						
	<table border="1"> <tr> <td>$\Delta C/C$</td> <td>$\leq \pm 15\%$ of initial value</td> </tr> <tr> <td>$\tan \delta$</td> <td>≤ 1.75 times initial specified limit</td> </tr> <tr> <td>I_{leak}</td> <td>\leq initial specified limit</td> </tr> </table>	$\Delta C/C$	$\leq \pm 15\%$ of initial value	$\tan \delta$	≤ 1.75 times initial specified limit	I_{leak}	\leq initial specified limit
$\Delta C/C$	$\leq \pm 15\%$ of initial value						
$\tan \delta$	≤ 1.75 times initial specified limit						
I_{leak}	\leq initial specified limit						
Voltage Endurance test 85°C; V_R	2000 h						
	Post test requirements:						
Vibration Resistance test	To IEC 60068-2-6, test Fc:						
	Displacement amplitude 0.75 mm, frequency range 10 ... 55 Hz, acceleration max. 10 g, duration 3x2 h. Capacitor mounted by its body which is rigidly clamped to the work surface.						
Characteristics at low temperature	Max. impedance ratio at 120 Hz						
	<table border="1"> <tr> <td>$V_R(V)$</td> <td>350-450</td> </tr> <tr> <td>$Z_{-25^\circ C} / Z_{20^\circ C}$</td> <td>4</td> </tr> <tr> <td>$Z_{-40^\circ C} / Z_{20^\circ C}$</td> <td>10</td> </tr> </table>	$V_R(V)$	350-450	$Z_{-25^\circ C} / Z_{20^\circ C}$	4	$Z_{-40^\circ C} / Z_{20^\circ C}$	10
	$V_R(V)$	350-450					
$Z_{-25^\circ C} / Z_{20^\circ C}$	4						
$Z_{-40^\circ C} / Z_{20^\circ C}$	10						
Sectional specification	IEC 60384-4 and JIS-C-5101						

Screw

Multiplier for Ripple Current vs. Frequency

Frequency(Hz)	50	120	300	1K	$\geq 3K$
Multiplier	0.8	1	1.2	1.3	1.4

Dimensional drawings

Threaded stud mounting

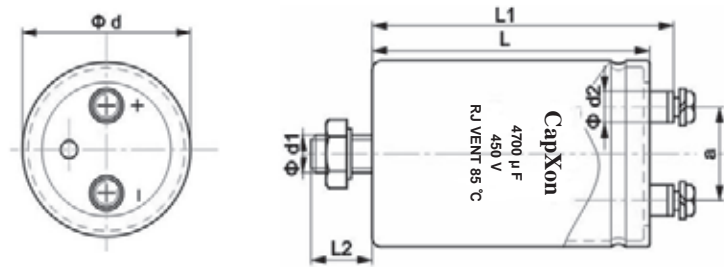

M5:Min.reach of screw = 8mm
 M6:Min.reach of screw = 12mm
 M8:Min.reach of screw = 16mm

Dimensions

Terminal	Dimensions(mm) with insulating sleeve						
	$d \pm 2$	$L \pm 3$	$L_1 \pm 3$	$L_2 + / - 1$	d_1	$d_2 \text{max.}$	$a \pm 0.5$
M5	63.5	80~140	86.5~146.5	16	M12	10.3	28.6
M5/M6	76.2/89	100~240	106.4~246.5	16	M12	10.3	31.8
M5/M6	76.2/89	100~240	106.4~246.5	16	M12	17.5	31.8
M8	100	100~240	110~250	16	M12	17.5	41.5

Packing

Capacitor diameter d(mm)	length l(mm)	Packing units (pcs.)
63.5	all	24
76.2	all	15
89	all	12
100	all	6

Packing of screw

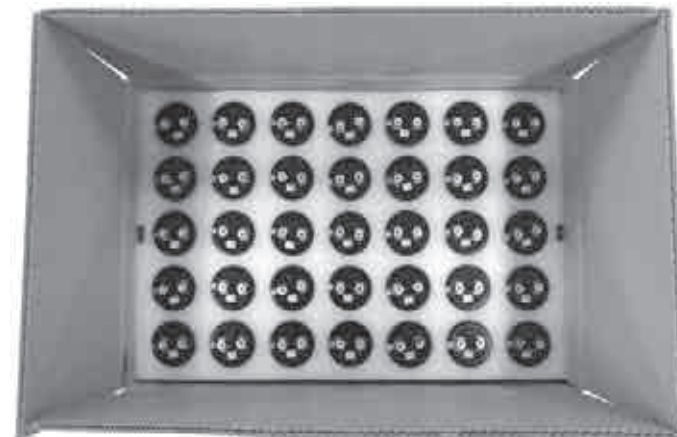

Accessories

The following items are included in the delivery package, but are not fastened to the capacitors.

	Thread	Maximum torque
For terminals	M5	2 Nm
	M6	2.5 Nm
	M8	5.0 Nm
For mounting	M12	10 Nm

Case Size

WV (Vdc)	Cap (uF)	Size (mm)	Rated Ripple current (Arms/85°C /120Hz)	Typ. ESR 20°C 120Hz (mΩ)	MAX ESR 20°C 120Hz (mΩ)
350	2700	63.5x80	12.8	42	74
350	3300	63.5x100	14.2	34	60
350	3900	63.5x105	14.6	29	51
350	4700	63.5x120	15.0	24	42
350	4700	63.5x140	15.5	24	42
350	4700	76.2x100	19.7	24	42
350	5600	63.5x140	21.5	20	36
350	6800	76.2x120	22.5	17	29
350	6800	76.2x140	24.0	17	29
350	6800	89x100	23.0	17	29
350	8200	76.2x160	26.0	14	24
350	10000	76.2x160	27.5	11	20
350	10000	89x120	26.0	11	20
350	12000	76.2x180	29.0	10	17
350	12000	76.2x220	32.0	10	17
350	15000	89x160	34.0	8	13
350	15000	89x220	39.0	8	13
350	18000	89x220	40.0	6	11
350	22000	89x230	42.0	5	9
400	2700	63.5x105	10.8	42	74
400	3300	63.5x100	11.0	34	60
400	3300	63.5x120	12.0	34	60
400	3900	76.2x100	14.0	29	51
400	3900	76.2x105	14.3	29	51
400	4700	76.2x100	15.7	24	42
400	4700	76.2x120	17.0	24	42
400	5600	76.2x140	18.8	20	36
400	6800	76.2x140	22.0	17	29

WV (Vdc)	Cap (uF)	Size (mm)	Rated Ripple current (Arms/85°C /120Hz)	Typ. ESR 20°C 120Hz (mΩ)	MAX ESR 20°C 120Hz (mΩ)
400	6800	76.2x160	23.0	17	29
400	8200	76.2x160	23.5	14	24
400	10000	76.2x160	24.0	11	20
400	10000	89x130	25.0	11	20
400	12000	89x160	25.5	10	17
400	12000	89x220	28.5	10	17
400	15000	76.2x230	33.0	8	13
400	15000	89x180	32.0	8	13
400	15000	89x220	35.0	8	13
400	18000	89x240	38.0	6	11
450	1500	63.5x80	11.4	74	130
450	2200	63.5x100	12.5	52	90
450	2200	63.5x105	12.8	52	90
450	2200	63.5x120	13.5	52	90
450	2700	76.2x105	14.6	42	74
450	3300	63.5x120	15.0	34	60
450	3300	63.5x140	16.0	34	60
450	3300	76.2x120	17.7	34	60
450	3900	76.2x120	18.0	29	51
450	3900	76.2x140	19.0	29	51
450	4700	76.2x120	18.3	24	42
450	4700	76.2x140	19.6	24	42
450	4700	76.2x160	20.5	24	42
450	5600	76.2x160	21.0	20	36
450	6800	76.2x160	22.0	17	29
450	8200	76.2x220	25.6	14	24
450	10000	76.2x220	26.0	11	20
450	10000	89x170	26.0	11	20

Useful life

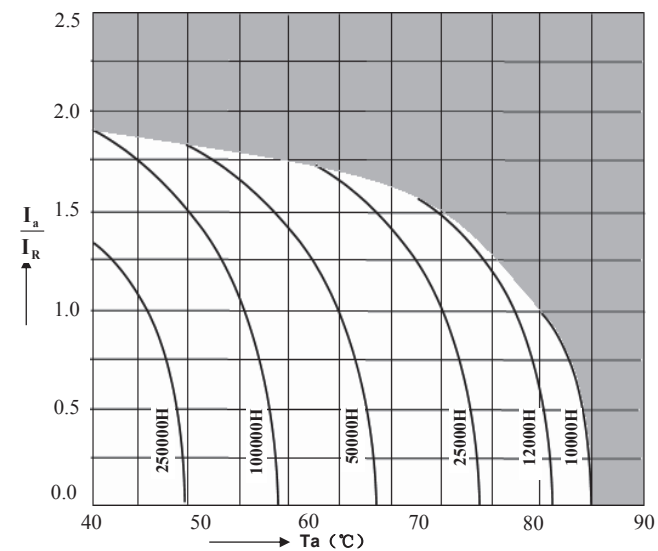

depending on ambient temperature T_a versus under ripple current operating conditions

RY Series 85°C

Features

Extremely Long useful life

Applications

- ◆ High reliability
- ◆ Professional power supplies
- ◆ Frequency converters
- ◆ Uninterruptible power supplies

Features

- ◆ Long useful life
- ◆ High reliability
- ◆ High reliability current capability
- ◆ Version with low-inductance design available
- ◆ All-welded construction ensures reliable electrical contact
- ◆ Self-extinguishing electrolyte
- ◆ RoHS-compatible

Construction

- ◆ Charge-discharge proof, polar
- ◆ Aluminum case with insulating sleeve
- ◆ Poles with screw terminal connections
- ◆ Mounting with ring clips, clamps or threaded stud



Specifications

Item	Performance Characteristics						
Operating Temperature Range	-40 to +85°C						
Rated voltage V_R	350 to 450 V DC						
Surge voltage V_S	$V_R \leq 315V$ 1.15 V_R $V_R > 315V$ 1.10 V_R						
Rated capacitance C_R	150 to 22000 μF						
Capacitance tolerance	$\pm 20\%$ (120Hz, +20°C)						
Leakage Current I_{leak} (+20°C, max.)	$I_{leak} = 0.018 \times (C \times V)^{0.85} + 4$ or 5mA, whichever is smaller (after 5 minutes) Where, I_{leak} : Max. leakage current (μA), C : Nominal capacitance (μF), V : Rated voltage (V)						
Dissipation Factor ($\tan \delta$, at 20°C, 120Hz)	Less than the value under table(%)						
	<table border="1"> <tr> <td>Working Voltage(VDC)</td> <td>350~450</td> </tr> <tr> <td>D.F. (%)max.</td> <td>15</td> </tr> </table>	Working Voltage(VDC)	350~450	D.F. (%)max.	15		
Working Voltage(VDC)	350~450						
D.F. (%)max.	15						
Self-inductance ESL	d = 51 mm: approx. 17 nH d \geq 63.5 mm: approx. 20 nH						
	Capacitors with low-inductance design: d \geq 63.5 mm: approx. 15 nH						
Useful life 85°C; $V_R, I_{AC, R}$	Requirements:						
	<table border="1"> <tr> <td>$\Delta C/C$</td> <td>$\leq \pm 15\%$ of initial value</td> </tr> <tr> <td>$\tan \delta$</td> <td>≤ 1.75 times initial specified limit</td> </tr> <tr> <td>I_{leak}</td> <td>\leq initial specified limit</td> </tr> </table>	$\Delta C/C$	$\leq \pm 15\%$ of initial value	$\tan \delta$	≤ 1.75 times initial specified limit	I_{leak}	\leq initial specified limit
$\Delta C/C$	$\leq \pm 15\%$ of initial value						
$\tan \delta$	≤ 1.75 times initial specified limit						
I_{leak}	\leq initial specified limit						
Voltage Endurance test 85°C; V_R	2000 h						
	Post test requirements:						
Vibration Resistance test	To IEC 60068-2-6, test Fc:						
	Displacement amplitude 0.75 mm, frequency range 10 ... 55 Hz, acceleration max. 10 g, duration 3x2 h. Capacitor mounted by its body which is rigidly clamped to the work surface.						
Characteristics at low temperature	Max. impedance ratio at 120 Hz						
	<table border="1"> <tr> <td>$V_R(V)$</td> <td>350-450</td> </tr> <tr> <td>$Z_{-25^\circ C} / Z_{20^\circ C}$</td> <td>4</td> </tr> <tr> <td>$Z_{-40^\circ C} / Z_{20^\circ C}$</td> <td>10</td> </tr> </table>	$V_R(V)$	350-450	$Z_{-25^\circ C} / Z_{20^\circ C}$	4	$Z_{-40^\circ C} / Z_{20^\circ C}$	10
	$V_R(V)$	350-450					
$Z_{-25^\circ C} / Z_{20^\circ C}$	4						
$Z_{-40^\circ C} / Z_{20^\circ C}$	10						
Sectional specification	IEC 60384-4 and JIS-C-5101						

Multiplier for Ripple Current vs. Frequency

Frequency(Hz)	50	120	300	1K	$\geq 3K$
Multiplier	0.8	1	1.2	1.3	1.4

Screw

Dimensional drawings

Threaded stud mounting

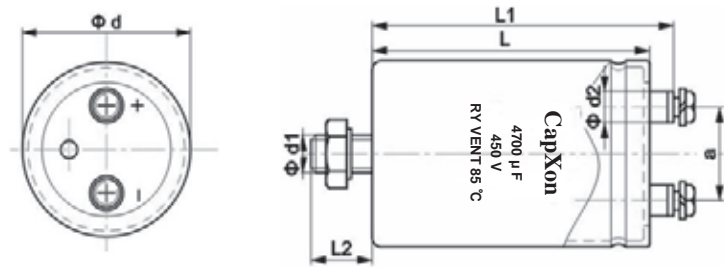

M5:Min.reach of screw = 8mm
 M6:Min.reach of screw = 12mm
 M8:Min.reach of screw = 16mm

Dimensions

Terminal	Dimensions(mm) with insulating sleeve						
	$d \pm 2$	$L \pm 3$	$L_1 \pm 3$	$L_2 + / - 1$	d_1	$d_2 \text{max.}$	$a \pm 0.5$
M5	63.5	80~140	86.5~146.5	16	M12	10.3	28.6
M5/M6	76.2/89	100~240	106.4~246.5	16	M12	10.3	31.8
M5/M6	76.2/89	100~240	106.4~246.5	16	M12	17.5	31.8
M8	100	100~240	110~250	16	M12	17.5	41.5

Packing

Capacitor diameter d(mm)	length l(mm)	Packing units (pcs.)
63.5	all	24
76.2	all	15
89	all	12
100	all	6

Packing of screw



Accessories

The following items are included in the delivery package, but are not fastened to the capacitors.

	Thread	Maximum torque
For terminals	M5	2 Nm
	M6	2.5 Nm
	M8	5.0 Nm
For mounting	M12	10 Nm

Case Size

WV (Vdc)	Cap (uF)	Size (mm)	Rated Ripple current (Arms/85°C /120Hz)	Typ. ESR 20°C 120Hz (mΩ)	MAX ESR 20°C 120Hz (mΩ)
350	2700	63.5x80	16.0	41	74
350	3300	63.5x100	19.0	33	60
350	3900	63.5x105	21.0	28	51
350	4700	63.5x120	22.0	24	42
350	4700	63.5x140	23.5	24	42
350	4700	76.2x100	24.0	24	42
350	5600	63.5x140	28.0	20	36
350	5600	76.2x105	30.0	20	36
350	6800	76.2x120	31.0	16	29
350	6800	76.2x140	33.0	16	29
350	6800	89x100	34.0	16	29
350	8200	76.2x140	36.0	13	24
350	8200	76.2x160	38.0	13	24
350	10000	76.2x160	42.0	11	20
350	10000	89x120	42.0	11	20
350	12000	76.2x180	45.0	9	17
350	12000	76.2x220	49.0	9	17
350	12000	89x145	51.0	9	17
350	15000	76.2x220	53.0	7	13
350	15000	89x160	53.0	7	13
350	15000	89x220	55.0	7	13
350	18000	89x220	58.0	6	11
350	22000	89x230	60.0	5	9
400	2700	63.5x105	17.0	41	74
400	3300	63.5x100	20.0	33	60
400	3300	63.5x120	21.5	33	60
400	3900	76.2x100	23.0	28	51
400	3900	76.2x105	23.5	28	51
400	4700	76.2x100	26.0	24	42
400	4700	76.2x120	28.0	24	42

WV (Vdc)	Cap (uF)	Size (mm)	Rated Ripple current (Arms/85°C /120Hz)	Typ. ESR 20°C 120Hz (mΩ)	MAX ESR 20°C 120Hz (mΩ)
400	5600	76.2x140	30.0	20	36
400	6800	76.2x140	33.0	16	29
400	6800	76.2x160	35.0	16	29
400	8200	76.2x160	36.5	13	24
400	10000	76.2x190	38.0	11	20
400	10000	89x160	39.0	11	20
400	12000	89x160	41.0	9	17
400	12000	89x220	46.0	9	17
400	15000	76.2x230	48.0	7	13
400	15000	89x180	52.0	7	13
400	15000	89x220	57.0	7	13
400	18000	89x240	60.0	6	11
450	1500	63.5x80	13.0	72	130
450	2200	63.5x100	14.0	50	90
450	2200	63.5x105	15.0	50	90
450	2200	63.5x120	16.0	50	90
450	2700	76.2x105	18.0	41	74
450	3300	63.5x140	23.0	33	60
450	3300	76.2x100	23.0	33	60
450	3300	76.2x120	25.0	33	60
450	3900	76.2x120	25.0	28	51
450	3900	76.2x140	26.7	28	51
450	4700	76.2x120	27.0	24	42
450	4700	76.2x140	28.0	24	42
450	4700	76.2x160	29.0	24	42
450	5600	76.2x160	31.5	20	36
450	6800	76.2x160	32.0	16	29
450	8200	76.2x220	36.0	13	24
450	10000	76.2x220	40.0	11	20
450	10000	89x170	40.0	11	20

Useful life

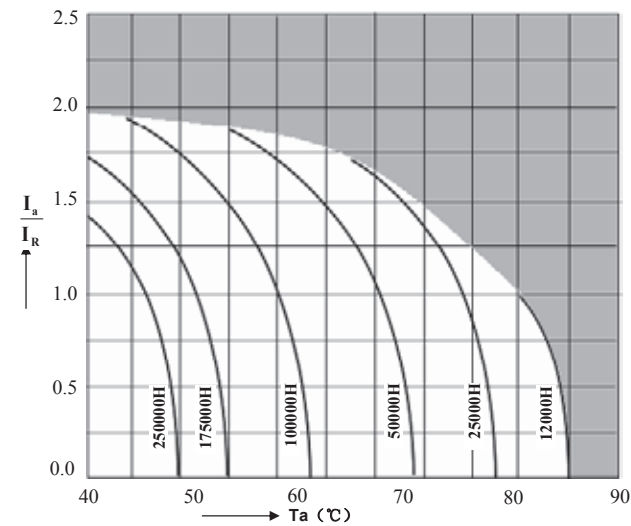

depending on ambient temperature T_a versus under ripple current operating conditions

RK Series 105°C

Features

General capacitors

Applications

- ◆ Professional power supplies
- ◆ Frequency converters
- ◆ Uninterruptible power supplies

Features

- ◆ Wide temperature range
- ◆ All-welded construction ensures reliable electrical contact
- ◆ Self-extinguishing electrolyte
- ◆ RoHS-compatible

Construction

- ◆ Charge-discharge proof, polar
- ◆ Aluminum case with insulating sleeve
- ◆ Poles with screw terminal connections
- ◆ Mounting with ring clips, clamps or threaded stud



Specifications

Item	Performance Characteristics																																																												
Operating Temperature Range	-40 to +105°C																																																												
Rated voltage V_R	10 to 100 V DC																																																												
Surge voltage V_S	1.15 V_R																																																												
Rated capacitance C_R	1800 to 1000000 μ F																																																												
Capacitance tolerance	$\pm 20\%$ (120Hz, +20°C)																																																												
Leakage Current I_{leak} (+20°C, max.)	$I_{leak} = 0.018 \times (C \times V)^{0.85} + 4$ or 5mA, whichever is smaller (after 5 minutes) Where, I_{leak} : Max. leakage current (μ A), C : Nominal capacitance (μ F), V : Rated voltage (V)																																																												
Dissipation Factor ($\tan \delta$, at 20°C, 120Hz)	Less than the value under table(%)																																																												
	<table border="1"> <thead> <tr> <th>ϕD</th> <th>35</th> <th>51</th> <th>63.5</th> <th>76.2</th> <th>89</th> </tr> </thead> <tbody> <tr> <td>10</td> <td>75</td> <td>100</td> <td>120</td> <td>150</td> <td>180</td> </tr> <tr> <td>16</td> <td>60</td> <td>70</td> <td>80</td> <td>120</td> <td>140</td> </tr> <tr> <td>25</td> <td>40</td> <td>50</td> <td>70</td> <td>80</td> <td>130</td> </tr> <tr> <td>35</td> <td>30</td> <td>50</td> <td>60</td> <td>70</td> <td>90</td> </tr> <tr> <td>40</td> <td>30</td> <td>50</td> <td>60</td> <td>70</td> <td>90</td> </tr> <tr> <td>50</td> <td>25</td> <td>30</td> <td>50</td> <td>60</td> <td>80</td> </tr> <tr> <td>63</td> <td>20</td> <td>25</td> <td>30</td> <td>40</td> <td>60</td> </tr> <tr> <td>80</td> <td>20</td> <td>20</td> <td>25</td> <td>30</td> <td>50</td> </tr> <tr> <td>100</td> <td>15</td> <td>20</td> <td>25</td> <td>30</td> <td>30</td> </tr> </tbody> </table>	ϕD	35	51	63.5	76.2	89	10	75	100	120	150	180	16	60	70	80	120	140	25	40	50	70	80	130	35	30	50	60	70	90	40	30	50	60	70	90	50	25	30	50	60	80	63	20	25	30	40	60	80	20	20	25	30	50	100	15	20	25	30	30
	ϕD	35	51	63.5	76.2	89																																																							
	10	75	100	120	150	180																																																							
	16	60	70	80	120	140																																																							
	25	40	50	70	80	130																																																							
	35	30	50	60	70	90																																																							
	40	30	50	60	70	90																																																							
	50	25	30	50	60	80																																																							
	63	20	25	30	40	60																																																							
80	20	20	25	30	50																																																								
100	15	20	25	30	30																																																								
Self-inductance ESL	d = 35 mm: approx. 10 nH																																																												
	d = 51 mm: approx. 15 nH																																																												
	d \geq 63.5 mm: approx. 20 nH																																																												
Useful life 105°C; $V_R, I_{AC,R}$	Requirements:																																																												
	$\Delta C/C \leq \pm 45\%$ of initial value																																																												
	ESR ≤ 3 times initial specified limit																																																												
	$I_{leak} \leq$ initial specified limit Failure rate : $\leq 1\%/1000$ hour																																																												
Voltage Endurance test 105°C; V_R	2000 h																																																												
	Post test requirements:																																																												
	DC/C $\leq \pm 15\%$ of initial value																																																												
	ESR ≤ 1.3 times initial specified limit $I_{leak} \leq$ initial specified limit																																																												
Vibration Resistance test	To IEC 60068-2-6, test Fc:																																																												
	Displacement amplitude 0.75 mm, frequency range 10 ... 55 Hz, acceleration max. 10 g, duration 3x2 h. Capacitor mounted by its body which is rigidly clamped to the work surface.																																																												
Characteristics at low temperature	Max. impedance ratio at 120 Hz																																																												
	<table border="1"> <tbody> <tr> <td>$Z_{-25^\circ C} / Z_{20^\circ C}$</td> <td>3</td> </tr> <tr> <td>$Z_{-40^\circ C} / Z_{20^\circ C}$</td> <td>12</td> </tr> </tbody> </table>	$Z_{-25^\circ C} / Z_{20^\circ C}$	3	$Z_{-40^\circ C} / Z_{20^\circ C}$	12																																																								
$Z_{-25^\circ C} / Z_{20^\circ C}$	3																																																												
$Z_{-40^\circ C} / Z_{20^\circ C}$	12																																																												
Sectional specification	IEC 60384-4 and JIS-C-5101																																																												

Screw

Multiplier for Ripple Current vs. Frequency

Rated voltage (V)	Case diameter (Φ)	Frequency(Hz)				
		50	120	1K	10K	≥50K
10 to 50	35 to 89	0.95	1	1.05	1.09	1.12
63 & 80	35	0.9	1	1.1	1.18	1.22
	50 to 89	0.95	1	1.05	1.09	1.12
100	35	0.8	1	1.22	1.3	1.33
	50	0.9	1	1.1	1.18	1.22
	63.5 to 89	0.95	1	1.05	1.09	1.12

Dimensional drawings

Ring clip/clamp mounting:

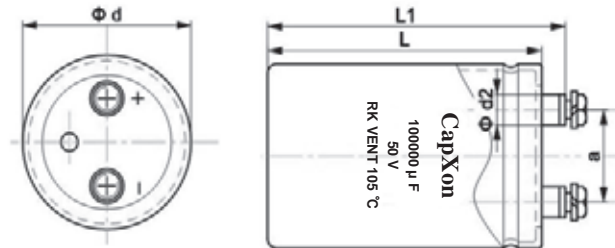

M5:Min.reach of screw = 8mm
M6:Min.reach of screw = 12mm

Dimensions

Terminal	Dimensions(mm) with insulating sleeve				
	d±2	L±3	L ₁ ±3	d ₂ max.	a±0.5
M5	35	50~120	56.5~126.5	10.3	12.7
M5	51	80~140	86.5~146.5	10.3	22
M5	63.5	80~140	86.5~146.5	10.3	28.6
M5	76.2/89	100~240	106.4~246.5	10.3	31.8
M6	76.2/89	100~240	106.4~246.5	17.5	31.8
M8	100	100~240	110~250	17.5	41.5

Packing

Capacitor diameter d(mm)	length l(mm)	Packing units (pcs.)
35	≤70mm	120
	>70mm	60
42	≤70mm	120
	>70mm	60
51	≤70mm	70
	>70mm	35
63.5	all	24
76.2	all	15
89	all	12
100	all	6

Packing of screw



Accessories

The following items are included in the delivery package, but are not fastened to the capacitors.

	Thread	Maximum torque
For terminals	M5	2 Nm
	M6	2.5 Nm
For mounting	M12	10 Nm

Case Size

WV (Vdc)	Cap (uF)	Size (mm)	Rated Ripple current (Arms/85°C /120Hz)	Typ. ESR 20°C 120Hz (mΩ)	MAX ESR 20°C 120Hz (mΩ)
10	27000	35x50	4.9	20	37
10	33000	35x50	5.1	15	30
10	39000	35x60	5.9	13	26
10	47000	35x80	7.1	12	21
10	56000	35x80	8.0	12	18
10	68000	35x100	8.5	10	18
10	68000	51x80	8.5	10	20
10	82000	35x100	8.9	8.0	17
10	100000	35x120	10.7	7.5	16
10	100000	51x80	10.7	7.5	16
10	120000	51x80	11.0	7.2	14
10	150000	51x100	13.2	7.0	12
10	180000	51x120	15.7	6.8	11
10	220000	51x120	16.8	6.5	10
10	270000	63.5x120	19.6	6.3	9.0
10	330000	63.5x120	20.5	6.0	8.5
10	390000	76.2x120	21.3	5.8	8.0
10	470000	76.2x120	22.0	5.5	7.5
10	560000	76.2x140	23.6	5.3	7.0
10	680000	89x140	26.0	5.0	6.5
10	680000	89x170	27.5	5.0	6.5
10	1000000	89x220	30.0	4.8	6.0
16	18000	35x50	4.2	24	44
16	22000	35x50	4.7	21	36
16	22000	35x60	4.9	21	36
16	27000	35x50	5.5	18	29
16	33000	35x65	5.7	16	24
16	33000	35x80	6.7	16	24
16	39000	35x65	6.8	14	20
16	47000	35x80	7.3	13	18
16	47000	35x100	8.8	13	18
16	56000	35x100	9.0	12	16
16	68000	35x100	9.2	12	15
16	68000	51x80	9.5	12	15
16	82000	51x80	10.7	10	14
16	100000	51x80	11.0	9.0	13
16	100000	51x100	12.5	9.0	13
16	120000	51x100	13.1	8.0	12
16	150000	51x120	15.5	7.0	11
16	180000	51x120	15.7	6.0	10
16	220000	63.5x120	18.0	5.5	9.5
16	270000	63.5x120	20.0	5.3	9.0
16	330000	76.2x120	21.3	5.0	8.8
16	390000	76.2x120	21.5	4.8	8.5
16	470000	76.2x140	24.2	4.5	8.3
16	470000	76.2x160	25.5	4.5	8.3
16	470000	89x140	26.5	4.5	8.3
16	560000	89x140	28.1	4.2	8.0
16	680000	89x140	28.5	4.0	7.8
16	1000000	89x220	35.0	3.8	7.5
25	10000	35x50	2.9	27	53
25	12000	35x50	3.7	23	44
25	15000	35x50	5.3	21	35
25	15000	35x55	5.5	21	35
25	18000	35x60	5.5	19	29
25	22000	35x60	6.5	14	24
25	22000	35x80	7.4	14	24
25	27000	35x80	8.0	12	20

WV (Vdc)	Cap (uF)	Size (mm)	Rated Ripple current (Arms/85°C /120Hz)	Typ. ESR 20°C 120Hz (mΩ)	MAX ESR 20°C 120Hz (mΩ)
25	33000	35x80	8.8	10	18
25	33000	35x100	9.7	10	18
25	39000	35x100	10.0	9.0	17
25	47000	35x105	11.0	8.0	15
25	47000	35x120	11.7	8.0	15
25	47000	51x80	12.0	8.0	17
25	56000	51x80	12.5	7.0	14
25	68000	51x80	13.0	6.0	13
25	68000	51x100	14.3	6.0	13
25	82000	51x100	14.6	5.5	12
25	100000	51x105	15.0	5.0	10
25	100000	51x120	16.0	5.0	10.0
25	100000	63.5x100	16.3	5.0	10.0
25	120000	63.5x100	17.0	4.7	9.0
25	150000	63.5x105	18.0	4.5	8.0
25	150000	63.5x120	19.0	4.5	8.0
25	180000	63.5x120	19.5	4.3	7.0
25	220000	76.2x105	20.0	4.0	6.0
25	220000	76.2x115	20.8	4.0	6.0
25	220000	76.2x120	21.2	4.0	6.0
25	270000	76.2x120	21.7	3.7	5.0
25	330000	76.2x145	24.0	3.7	4.5
25	330000	76.2x160	25.0	3.7	4.5
25	330000	89x130	25.0	3.7	4.5
25	330000	89x140	26.0	3.7	4.5
25	390000	89x140	26.5	3.5	4.4
25	470000	89x170	28.0	3.3	4.3
25	680000	89x220	31.0	3.0	4.2
35	6800	35x50	2.6	30.0	59
35	8200	35x50	3.3	25.0	49
35	10000	35x50	3.6	20.0	40
35	10000	35x60	3.8	20.0	40
35	12000	35x60	4.8	19.0	33
35	15000	35x60	5.6	17.0	27
35	15000	35x80	6.0	17.0	27
35	18000	35x80	6.3	15.0	22
35	22000	35x80	7.6	13.0	18
35	22000	35x100	7.9	13.0	18
35	27000	35x100	8.2	11.0	15
35	33000	35x120	10.2	9.0	13
35	33000	51x80	10.7	9.0	13
35	39000	51x80	11.0	7.0	12
35	47000	51x100	12.5	5.0	11
35	56000	51x100	13.0	4.8	10.5
35	68000	51x120	14.5	4.5	10.0
35	82000	63.5x100	14.8	4.3	9.3
35	100000	63.5x120	17.6	4.1	9.0
35	120000	63.5x120	18.0	4.0	8.5
35	150000	76.2x120	20.0	3.6	8.0
35	180000	76.2x120	20.5	3.5	7.5
35	220000	76.2x140	23.4	3.3	7.0
35	220000	76.2x160	25.0	3.3	7.0
35	220000	89x130	24.5	3.3	7.0
35	220000	89x140	25.0	3.3	7.0
35	270000	89x140	25.5	3.2	6.5
35	330000	89x160	30.0	3.1	6.3
35	330000	89x170	31.0	3.1	6.3
35	470000	89x220	34.0	3.0	6.0

WV (Vdc)	Cap (uF)	Size (mm)	Rated Ripple current (Arms/85°C /120Hz)	Typ. ESR 20°C 120Hz (mΩ)	MAX ESR 20°C 120Hz (mΩ)
40	10000	35x55	5.3	17.0	38
40	15000	35x80	7.4	12.0	23
40	22000	35x105	9.5	8.5	17
40	33000	51x80	11.0	6.0	12
40	47000	51x105	14.0	5.0	10.0
40	68000	51x105	15.0	4.5	9.0
40	100000	63.5x105	18.0	4.1	8.2
40	150000	76.2x105	20.0	3.6	7.2
40	220000	76.2x143	24.0	3.3	5.0
50	3300	35x50	2.2	47	100
50	3900	35x50	2.8	42	85
50	4700	35x50	3.3	35	71
50	5600	35x50	3.5	29	59
50	6800	35x50	3.7	25	49
50	6800	35x80	4.5	25	49
50	8200	35x60	4.5	23	40
50	10000	35x60	5.5	18	33
50	10000	35x80	5.8	18	33
50	12000	35x80	6.0	15	28
50	15000	35x80	7.6	13	22
50	18000	35x100	8.0	11	18
50	22000	35x120	9.8	9.0	15
50	22000	51x80	10.0	9.0	18
50	27000	51x80	10.2	8.0	15
50	33000	51x100	11.2	7.0	13
50	33000	51x115	11.5	7.0	13
50	33000	51x120	12.0	7.0	13
50	39000	51x120	13.2	6.5	12
50	47000	51x120	14.5	6.0	11
50	47000	63.5x100	14.5	6.0	11
50	56000	63.5x100	14.6	5.8	9.0
50	68000	63.5x115	16.0	5.5	8.0
50	68000	63.5x120	16.6	5.5	8.0
50	82000	76.2x120	18.9	5.3	7.0
50	100000	76.2x120	19.5	5.0	7.0
50	120000	76.2x120	20.0	4.8	6.8
50	150000	89x130	22.5	4.5	6.5
50	150000	89x140	23.9	4.5	6.5
50	180000	89x140	24.2	4.3	6.3
50	180000	89x155	25.0	4.3	6.3
50	220000	89x170	26.5	4.0	6.0
50	330000	89x220	32.0	3.8	5.5
63	2200	35x50	2.1	65	120
63	2700	35x50	2.3	46	98
63	3300	35x50	2.5	42	80
63	3900	35x50	2.8	37	68
63	4700	35x50	3.5	30	56
63	4700	35x55	4.4	30	56
63	5600	35x60	4.7	26	47
63	6800	35x60	5.3	22	39
63	6800	35x80	6.0	22	39
63	8200	35x80	6.2	18	32
63	10000	35x80	7.2	14	27
63	10000	35x100	7.8	14	27
63	10000	35x105	8.1	14	27
63	12000	35x100	8.3	12	22
63	15000	35x120	8.8	9.5	19
63	15000	51x80	9.5	9.5	19
63	18000	51x80	10.0	9.0	17
63	22000	51x100	11.0	7.0	14

WV (Vdc)	Cap (uF)	Size (mm)	Rated Ripple current (Arms/85°C /120Hz)	Typ. ESR 20°C 120Hz (mΩ)	MAX ESR 20°C 120Hz (mΩ)
63	22000	51x105	12.0	7.0	14
63	27000	51x120	12.5	6.3	12
63	33000	51x120	14.0	5.5	11
63	33000	63.5x100	14.5	5.5	11
63	33000	63.5x105	15.0	5.5	11
63	39000	63.5x100	15.0	5.3	11
63	47000	63.5x105	17.0	4.8	10
63	56000	63.5x120	18.0	4.5	9.0
63	68000	63.5x140	19.5	4.3	8.0
63	68000	76.2x105	19.0	4.3	8.0
63	68000	76.2x120	20.0	4.3	8.0
63	82000	76.2x140	21.0	4.1	7.5
63	100000	76.2x140	22.5	4.0	7.0
63	100000	76.2x145	23.0	4.0	7.0
63	100000	89x130	24.0	4.0	7.0
63	120000	89x140	25.0	3.8	6.5
63	150000	89x160	27.0	3.5	6.0
63	150000	89x170	28.0	3.5	6.0
63	220000	89x220	29.5	3.3	5.0
80	2200	35x50	2.4	63	120
80	2700	35x50	2.7	45	98
80	3300	35x50	3.0	40	80
80	3900	35x60	3.4	35	68
80	4700	35x60	4.6	28	56
80	5600	35x80	5.0	25	47
80	6800	35x80	5.5	21	39
80	8200	35x100	6.5	17	32
80	10000	35x120	8.5	13	27
80	12000	51x80	8.6	12	22
80	15000	51x100	10.0	9.0	18
80	18000	51x120	10.5	8.0	15
80	22000	51x100	13.0	7.0	12
80	22000	51x120	13.5	7.0	12
80	22000	63.5x100	13.7	7.0	15
80	27000	63.5x100	14.0	6.0	12
80	33000	51x140	14.0	5.5	11
80	33000	76.2x100	15.0	5.5	11
80	39000	76.2x100	15.0	5.3	10
80	47000	63.5x140	16.5	4.8	9.0
80	47000	76.2x120	16.5	4.8	8.5
80	56000	76.2x120	18.5	4.5	8.0
80	68000	76.2x140	22.0	4.3	7.0
80	82000	89x130	22.5	4.0	6.5
80	100000	89x160	24.8	3.8	6.3
80	100000	89x170	25.0	3.8	6.3
80	150000	89x220	27.0	3.5	6.0
100	1000	35x50	1.4	65.0	120
100	1500	35x50	2.2	52.0	104
100	1800	35x50	2.7	43.0	85
100	2200	35x50	3.0	35.0	70
100	2200	35x60	4.1	35.0	60
100	2700	35x60	4.7	29.0	55
100	3300	35x80	5.7	24.0	48
100	3900	35x80	6.0	21.0	42
100	4700	35x100	6.5	18.0	35
100	4700	35x105	6.7	18.0	35
100	4700	51x80	6.5	18.0	35
100	5600	35x100	6.8	15.0	30
100	6800	35x120	7.0	12.0	24
100	6800	51x80	8.7	12.0	24

WV (Vdc)	Cap (uF)	Size (mm)	Rated Ripple current (Arms/85°C /120Hz)	Typ. ESR 20°C 120Hz (mΩ)	MAX ESR 20°C 120Hz (mΩ)
100	6800	51x100	9.5	12.0	19
100	8200	51x80	10.0	9.0	32
100	10000	51x100	10.5	7	14
100	10000	51x105	11.0	7	14
100	10000	51x120	12.5	7	14
100	12000	51x120	13.0	6	12
100	15000	63.5x100	14.5	5	10
100	15000	63.5x105	15.0	5	10
100	15000	63.5x120	16.0	5	10
100	18000	63.5x100	16.0	4.8	9.5
100	22000	63.5x120	16.5	4.5	9.0
100	22000	76.2x100	16.5	4.5	9.0
100	22000	76.2x105	17.0	4.5	9.0
100	22000	76.2x120	18.0	4.5	9.0

WV (Vdc)	Cap (uF)	Size (mm)	Rated Ripple current (Arms/85°C /120Hz)	Typ. ESR 20°C 120Hz (mΩ)	MAX ESR 20°C 120Hz (mΩ)
100	27000	76.2x120	18.5	4.3	8.5
100	33000	76.2x120	16.0	4.0	8.0
100	33000	76.2x130	19.5	4.0	8.0
100	33000	76.2x140	20.5	4.0	8.0
100	33000	76.2x145	21.0	4.0	8.0
100	39000	76.2x140	21.0	3.8	7.8
100	47000	76.2x160	23.0	3.5	7.5
100	47000	89x130	22.0	3.5	7.5
100	47000	89x140	23.5	3.5	7.5
100	56000	89x140	24.0	3.3	7.3
100	68000	89x160	25.5	3.2	7.0
100	68000	89x170	26.0	3.2	7.0
100	100000	89x220	28.0	3.0	6.5
100	100000	89x230	30.0	3.0	6.5

Useful life

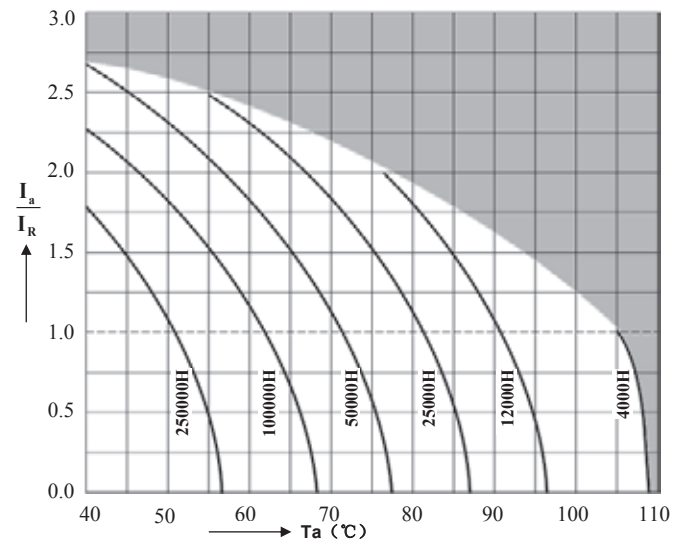

depending on ambient temperature T_a versus under ripple current operating conditions

RL Series 105°C

Features

Long load life

Applications

- ◆ Professional power supplies
- ◆ Frequency converters
- ◆ Uninterruptible power supplies

Features

- ◆ Outstanding reliability
- ◆ Wide temperature range
- ◆ Version with low-inductance design available
- ◆ All-welded construction ensures reliable electrical contact
- ◆ Self-extinguishing electrolyte
- ◆ RoHS-compatible

Construction

- ◆ Charge-discharge proof, polar
- ◆ Aluminum case with insulating sleeve
- ◆ Poles with screw terminal connections
- ◆ Mounting with ring clips, clamps or threaded stud



Specifications

Item	Performance Characteristics		
Operating Temperature Range	-40 to +105°C		-25 to +85°C
Rated voltage V_R	160 to 450 V DC		500 V DC
Surge voltage V_S	$V_R \leq 315V$ 1.15 V_R $V_R > 315V$ 1.10 V_R		
Rated capacitance C_R	220 to 22000 μF		680 to 8200 μF
Capacitance tolerance	$\pm 20\%$ (120Hz, +20°C)		
Leakage Current I_{leak} (+20°C, max.)	$I_{leak} = 0.018 \times (C \times V)^{0.85} + 4$ or 5mA, whichever is smaller (after 5 minutes) Where, I_{leak} : Max. leakage current (μA), C : Nominal capacitance (μF), V : Rated voltage (V)		
Dissipation Factor (tan δ , at 20°C, 120Hz)	Less than the value under table(%)		
	Working Voltage(VDC)	160~450	500~550
	D.F. (%)max.	15	20
Self-inductance ESL	d = 51 mm: approx. 17 nH		
	d \geq 63.5 mm: approx. 20 nH		
	Capacitors with low-inductance design: d \geq 63.5 mm: approx. 15 nH		
Useful life 105°C; $V_R, I_{AC, R}$	>10000 h	Requirements:	
		$\Delta C/C$	$\leq \pm 15\%$ of initial value
		tan δ	≤ 1.75 times initial specified limit
		I_{leak}	\leq initial specified limit
Voltage Endurance test 105°C; V_R	5000 h	Post test requirements:	
		$\Delta C/C$	$\leq \pm 10\%$ of initial value
		tan δ	≤ 1.3 times initial specified limit
		I_{leak}	\leq initial specified limit
Vibration Resistance test	To IEC 60068-2-6, test Fc:		
	Displacement amplitude 0.75 mm, frequency range 10 ... 55 Hz, acceleration max. 10 g, duration 3x2 h. Capacitor mounted by its body which is rigidly clamped to the work surface.		
Characteristics at low temperature	Max. impedance ratio at 120 Hz		
	$V_R(V)$	160-450	≥ 500
	$Z_{-25^\circ C} / Z_{20^\circ C}$	4	4
	$Z_{-40^\circ C} / Z_{20^\circ C}$	10	-
Sectional specification	IEC 60384-4 and JIS-C-5101		

Multiplier for Ripple Current vs. Frequency

Frequency(Hz)	50	120	300	1K	$\geq 3K$
Multiplier	0.8	1	1.2	1.3	1.4

Dimensional drawings

Ring clip/clamp mounting:

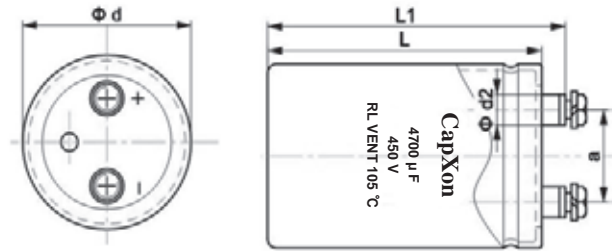

M5:Min.reach of screw = 8mm
 M6:Min.reach of screw = 12mm
 M8:Min.reach of screw = 16mm

Dimensions

Terminal	Dimensions(mm) with insulating sleeve				
	d±2	L±3	L ₁ ±3	d ₂ max.	a±0.5
M5	35	50~120	56.5~126.5	10.3	12.7
M5	51	80~140	86.5~146.5	10.3	22
M5	63.5	80~140	86.5~146.5	10.3	28.6
M5	76.2/89	100~240	106.4~246.5	10.3	31.8
M6	76.2/89	100~240	106.4~246.5	17.5	31.8
M8	100	100~240	110~250	17.5	41.5

Packing

Capacitor diameter d(mm)	length l(mm)	Packing units (pcs.)
35	≤70mm	120
	>70mm	60
42	≤70mm	120
	>70mm	60
51	≤70mm	70
	>70mm	35
63.5	all	24
76.2	all	15
89	all	12
100	all	6

Packing of screw



Accessories

The following items are included in the delivery package, but are not fastened to the capacitors.

	Thread	Maximum torque
For terminals	M5	2 Nm
	M6	2.5 Nm
	M8	5.0 Nm
For mounting	M12	10 Nm

Case Size

WV (Vdc)	Cap (uF)	Size (mm)	Rated Ripple current (Arms/85°C /120Hz)	Typ. ESR 20°C 120Hz (mΩ)	MAX ESR 20°C 120Hz (mΩ)
160	680	35x50	1.6	150	290
160	820	35x80	2.2	120	240
160	1000	35x80	2.5	100	200
160	1200	35x80	2.7	87	170
160	1500	35x80	2.9	67	130
160	1800	35x100	3.6	56	110
160	2200	35x120	4.2	46	90
160	2700	35x120	4.6	38	74
160	3300	51x100	5.8	31	60
160	3900	51x120	6.8	26	51
160	4700	51x120	7.5	22	42
160	5600	51x120	8.3	18	36
160	6800	63.5x120	10.2	15	29
160	8200	76.2x100	11.5	12	24
160	10000	76.2x120	13.0	10	20
160	12000	76.2x140	14.5	9	17
160	15000	89x140	17.3	7	13
200	470	35x50	1.3	220	420
200	560	35x80	1.7	180	360
200	680	35x80	1.9	150	290
200	820	35x80	2.1	120	240
200	1000	35x100	2.6	100	200
200	1200	35x120	3.1	87	170
200	1500	35x120	3.5	67	130
200	1800	51x80	3.8	56	110
200	2200	51x100	4.7	46	90
200	2700	51x120	5.7	38	74
200	3300	51x120	6.2	31	60
200	3900	63.5x100	7.1	26	51
200	4700	63.5x120	8.3	22	42
200	5600	76.2x100	9.4	18	36
200	6800	76.2x120	11.0	15	29
200	8200	76.2x140	13.0	12	24
200	10000	89x140	15.8	10	20
250	330	35x50	1.1	310	600
250	390	35x80	1.5	260	510
250	470	35x80	1.6	220	420
250	560	35x80	1.8	180	360
250	680	35x100	2.1	150	290
250	820	35x100	2.3	120	240
250	1000	35x120	2.8	100	200
250	1200	51x80	3.2	87	170
250	1500	51x100	3.9	67	130
250	1800	51x120	4.6	56	110
250	2200	51x120	5.1	46	90
250	2700	63.5x100	6.0	38	74
250	3300	63.5x120	7.0	31	60
250	3900	76.2x100	7.9	26	51
250	4700	76.2x120	9.2	22	42
250	5600	76.2x140	10.7	18	36
250	6800	89x140	12.9	15	29
350	330	35x80	2.2	310	600
350	470	35x80	2.9	220	420
350	680	51x60	3.7	150	290
350	820	51x60	3.8	120	240
350	1000	51x75	6.4	100	200
350	1000	51x80	6.6	100	200
350	1200	51x75	6.6	87	170

WV (Vdc)	Cap (uF)	Size (mm)	Rated Ripple current (Arms/85°C /120Hz)	Typ. ESR 20°C 120Hz (mΩ)	MAX ESR 20°C 120Hz (mΩ)
350	1200	51x80	6.7	87	170
350	1500	51x80	8.0	67	130
350	1500	51x96	8.7	67	130
350	1800	51x96	8.8	56	110
350	1800	51x120	9.7	56	110
350	2200	51x98	10.1	46	90
350	2200	51x120	11.0	46	90
350	2700	51x98	10.5	38	74
350	2700	51x125	11.7	38	74
350	2700	63.5x85	11.9	38	74
350	2700	63.5x100	12.8	38	74
350	3300	51x118	11.5	31	60
350	3300	51x145	12.6	31	60
350	3300	63.5x100	13.8	31	60
350	3900	63.5x100	15.1	26	51
350	3900	63.5x130	16.9	26	51
350	3900	76.2x100	16.7	26	51
350	4700	63.5x115	17.9	22	42
350	4700	76.2x110	19.4	22	42
350	5600	63.5x135	20.5	18	36
350	5600	63.5x170	22.8	18	36
350	5600	76.2x125	22.2	18	36
350	5600	89x105	24.1	18	36
350	6800	63.5x189	26.4	15	29
350	6800	76.2x125	24.3	15	29
350	6800	76.2x150	26.3	15	29
350	6800	89x119	27.3	15	29
350	8200	63.5x244	32.5	12	24
350	8200	76.2x136	27.5	12	24
350	8200	76.2x170	30.4	12	24
350	8200	89x120	28.5	12	24
350	8200	89x150	31.4	12	24
350	10000	76.2x190	31.6	10	20
350	10000	76.2x220	33.8	10	20
350	10000	89x136	29.7	10	20
350	10000	89x170	32.7	10	20
350	12000	76.2x240	35.3	9	17
350	12000	89x136	29.8	9	17
350	12000	89x190	34.3	9	17
350	12000	100x190	36.8	9	17
350	15000	89x176	39.0	7	13
350	15000	89x220	43.0	7	13
350	15000	100x250	48.7	7	13
350	18000	89x186	40.0	6	11
350	18000	89x240	44.9	6	11
350	22000	89x230	45.2	5	9
350	22000	89x270	48.7	5	9
350	22000	100x250	50.0	5	9
400	220	35x80	1.7	460	900
400	330	35x80	2.4	310	600
400	470	35x100	3.2	220	420
400	680	51x60	3.8	150	290
400	680	51x80	4.3	150	290
400	1000	51x75	6.5	100	200
400	1000	51x80	6.7	100	200
400	1200	51x80	7.0	87	170
400	1200	51x96	7.7	87	170
400	1500	51x96	8.8	67	130

WV (Vdc)	Cap (uF)	Size (mm)	Rated Ripple current (Arms/85°C /120Hz)	Typ. ESR 20°C 120Hz (mΩ)	MAX ESR 20°C 120Hz (mΩ)
400	1500	51x115	9.5	67	130
400	1800	51x105	9.6	56	110
400	1800	51x140	10.8	56	110
400	1800	63.5x85	9.9	56	110
400	2200	51x105	10.5	46	90
400	2200	51x125	11.3	46	90
400	2200	63.5x85	10.8	46	90
400	2200	63.5x100	11.6	46	90
400	2700	51x145	13.6	38	74
400	2700	63.5x90	12.4	38	74
400	2700	63.5x115	13.7	38	74
400	3300	63.5x95	14.5	31	60
400	3300	63.5x130	16.7	31	60
400	3300	76.2x75	14.7	31	60
400	3300	76.2x100	16.5	31	60
400	3900	63.5x100	15.8	26	51
400	3900	63.5x150	18.9	26	51
400	3900	76.2x85	15.3	26	51
400	3900	76.2x110	18.3	26	51
400	3900	76.2x130	19.7	26	51
400	4700	63.5x120	18.6	22	42
400	4700	63.5x170	21.7	22	42
400	4700	76.2x95	18.6	22	42
400	4700	76.2x130	21.2	22	42
400	5600	63.5x135	22.1	18	36
400	5600	63.5x190	25.8	18	36
400	5600	76.2x105	21.9	18	36
400	5600	76.2x150	25.6	18	36
400	5600	89x105	24.3	18	36
400	6800	63.5x250	31.2	15	29
400	6800	76.2x125	25.2	15	29
400	6800	76.2x170	28.9	15	29
400	6800	89x105	25.9	15	29
400	6800	89x125	27.9	15	29
400	6800	89x140	29.3	15	29
400	6800	89x150	31.0	15	29
400	6800	89x155	31.4	15	29
400	8200	76.2x170	30.6	12	24
400	8200	76.2x210	33.7	12	24
400	8200	89x115	28.2	12	24
400	8200	89x125	29.2	12	24
400	8200	89x160	32.5	12	24
400	8200	89x170	33.4	12	24
400	10000	76.2x220	36.4	10	20
400	10000	89x135	31.9	10	20
400	10000	89x190	37.1	10	20
400	10000	100x190	39.6	10	20
400	12000	89x165	36.8	9	17
400	12000	89x190	39.1	9	17
400	12000	89x220	41.8	9	17
400	12000	100x220	44.6	9	17
400	15000	89x195	39.6	7	13
400	15000	89x240	43.5	7	13
400	15000	100x220	44.6	7	13
400	18000	89x235	44.0	6	11
400	18000	89x270	46.9	6	11
450	220	35x80	1.9	460	900
450	330	35x100	2.5	310	600
450	470	51x60	3.0	220	420
450	560	51x60	3.3	180	360

WV (Vdc)	Cap (uF)	Size (mm)	Rated Ripple current (Arms/85°C /120Hz)	Typ. ESR 20°C 120Hz (mΩ)	MAX ESR 20°C 120Hz (mΩ)
450	680	51x85	4.5	150	290
450	1000	51x85	6.9	100	200
450	1000	51x105	7.6	100	200
450	1200	51x85	7.4	87	170
450	1200	51x115	8.5	87	170
450	1500	51x100	9.1	67	130
450	1500	51x115	9.6	67	130
450	1800	51x100	9.5	56	110
450	1800	63.5x85	10.0	56	110
450	2200	51x120	11.5	46	90
450	2200	63.5x100	12.0	46	90
450	2700	51x143	13.8	38	74
450	2700	63.5x100	13.2	38	74
450	2700	63.5x130	14.8	38	74
450	2700	76.2x85	13.7	38	74
450	2700	76.2x115	15.6	38	74
450	3300	63.5x115	14.7	31	60
450	3300	63.5x150	16.6	31	60
450	3300	76.2x95	16.2	31	60
450	3300	76.2x130	18.5	31	60
450	3900	63.5x135	18.0	26	51
450	3900	63.5x170	20.0	26	51
450	3900	76.2x105	17.9	26	51
450	3900	76.2x130	19.8	26	51
450	3900	89x105	19.6	26	51
450	4700	63.5x165	21.6	22	42
450	4700	76.2x115	20.4	22	42
450	4700	76.2x130	21.5	22	42
450	4700	76.2x150	22.9	22	42
450	4700	89x105	21.5	22	42
450	5600	63.5x244	29.4	18	36
450	5600	76.2x135	22.5	18	36
450	5600	76.2x150	25.9	18	36
450	5600	76.2x190	28.8	18	36
450	5600	89x105	24.8	18	36
450	5600	89x125	26.1	18	36
450	5600	89x150	28.9	18	36
450	6800	76.2x170	29.0	15	29
450	6800	76.2x190	30.5	15	29
450	6800	76.2x220	32.6	15	29
450	6800	89x115	26.7	15	29
450	6800	89x125	27.7	15	29
450	6800	89x170	31.6	15	29
450	8200	76.2x195	33.6	12	24
450	8200	76.2x240	37.0	12	24
450	8200	89x145	32.1	12	24
450	8200	89x190	36.2	12	24
450	10000	89x165	34.9	10	20
450	10000	89x190	37.2	10	20
450	10000	89x220	39.7	10	20
450	10000	100x220	42.3	10	20
450	12000	89x195	39.4	9	17
450	12000	89x230	42.5	9	17
450	12000	100x250	47.0	9	17
450	15000	89x235	44.4	7	13
450	15000	89x250	45.7	7	13
500	680	51x75	4.1	200	390
500	1000	51x90	5.1	140	270
500	1200	51x115	5.9	110	220
500	1200	63.5x80	5.7	110	220

WV (Vdc)	Cap (uF)	Size (mm)	Rated Ripple current (Arms/85°C /120Hz)	Typ. ESR 20°C 120Hz (mΩ)	MAX ESR 20°C 120Hz (mΩ)
500	1500	51x135	7.1	92	180
500	1500	63.5x90	6.7	92	180
500	1800	63.5x100	7.8	77	150
500	1800	76.2x70	7.5	77	150
500	2200	63.5x120	8.6	62	120
500	2200	76.2x95	8.6	62	120
500	2700	63.5x135	9.8	50	98
500	2700	76.2x105	9.7	50	98
500	3300	63.5x165	11.0	41	80

WV (Vdc)	Cap (uF)	Size (mm)	Rated Ripple current (Arms/85°C /120Hz)	Typ. ESR 20°C 120Hz (mΩ)	MAX ESR 20°C 120Hz (mΩ)
500	3300	76.2x130	11.0	41	80
500	3900	76.2x145	13.1	35	68
500	3900	89x105	12.5	35	68
500	4700	76.2x165	14.5	29	56
500	4700	89x125	14.0	29	56
500	5600	89x145	15.9	24	47
500	6800	89x165	18.6	20	39
500	8200	89x205	20.3	17	32

Useful life

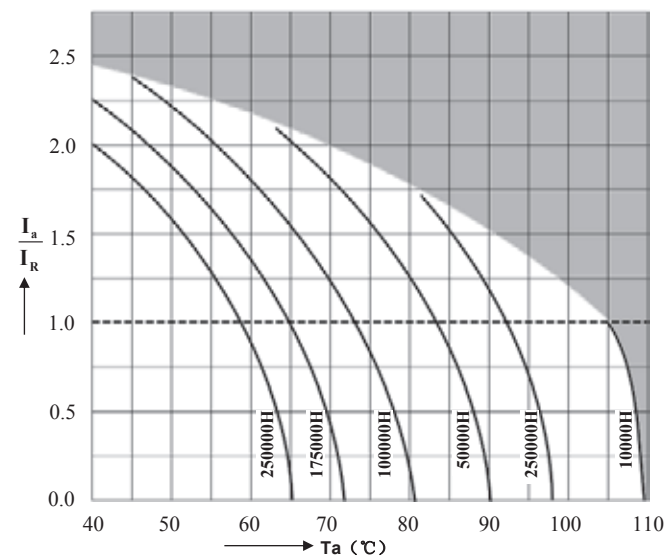

depending on ambient temperature T_a versus under ripple current operating conditions

RM Series 105°C



Features

Long useful life

Applications

- ◆ Frequency converters
- ◆ Professional power supplies
- ◆ Hybrid electric vehicles(HEV)
- ◆ Traction

Features

- ◆ High reliability
- ◆ long useful life
- ◆ Extremely high ripple current capability
- ◆ Wide temperature range
- ◆ All-welded construction ensures reliable electrical contact
- ◆ low-inductance design
- ◆ Self-extinguishing electrolyte
- ◆ RoHS-compatible

Construction

- ◆ Charge-discharge proof, polar
- ◆ Aluminum case with insulating sleeve
- ◆ Poles with screw terminal connections
- ◆ Mounting with ring clips, clamps or threaded stud

Specifications

Item	Performance Characteristics		
Operating Temperature Range	-40 to +105°C (160Vdc~450Vdc) -25 to +105°C (500Vdc)		
Rated voltage V_R	160 to 500 V DC		
Surge voltage V_S	$V_R \leq 315V$ 1.15 V_R $V_R > 315V$ 1.10 V_R		
Rated capacitance C_R	180 to 68000 μF		
Capacitance tolerance	$\pm 20\%$ (120Hz, +20°C)		
Leakage Current I_{leak} (+20°C.max.)	$I_{leak} = 0.018 \times (C \times V)^{0.85} + 4$ or 5mA, whichever is smaller (after 5 minutes) Where, I_{leak} : Max. leakage current (μA), C : Nominal capacitance (μF), V : Rated voltage (V)		
Dissipation Factor (tan δ , at 20°C, 120Hz)	Less than the value under table(%)		
	Working Voltage(VDC)	160~450	500~550
	D.F. (%)max.	15	20
Self-inductance ESL	d = 51 mm: approx. 16 nH		
	d \geq 63.5 mm: approx. 18 nH		
	Capacitors with low-inductance design: d \geq 63.5 mm: approx. 14 nH		
Useful life 105°C; V_R, I_{AC}, R	>6000 h	Requirements:	
		$\Delta C/C$	$\leq \pm 15\%$ of initial value
		tan δ	≤ 1.75 times initial specified limit
		I_{leak}	\leq initial specified limit
Voltage Endurance test 105°C; V_R	2000 h	Post test requirements:	
		$\Delta C/C$	$\leq \pm 10\%$ of initial value
		tan δ	≤ 1.3 times initial specified limit
		I_{leak}	\leq initial specified limit
Vibration Resistance test	To IEC 60068-2-6, test Fc:		
	Displacement amplitude 0.75 mm, frequency range 10 ... 55 Hz, acceleration max. 10 g, duration 3x2 h. Capacitor mounted by its body which is rigidly clamped to the work surface.		
Characteristics at low temperature	Max. impedance ratio at 120 Hz		
	$V_R(V)$	160-450	≥ 500
	$Z_{-25^\circ C} / Z_{20^\circ C}$	4	4
	$Z_{-40^\circ C} / Z_{20^\circ C}$	10	-
Sectional specification	IEC 60384-4 and JIS-C-5101		

Screw

Multiplier for Ripple Current vs. Frequency

Frequency(Hz)	50	120	300	1K	$\geq 3K$
Multiplier	0.8	1	1.2	1.3	1.4

Dimensional drawings

Ring clip/clamp mounting:

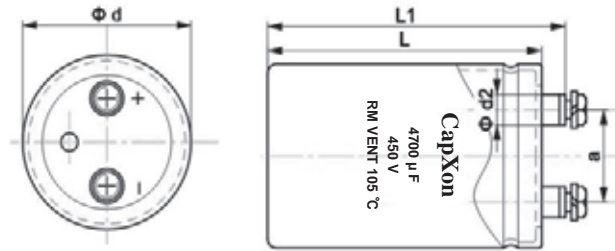

M5:Min.reach of screw = 8mm
 M6:Min.reach of screw = 12mm
 M8:Min.reach of screw = 16mm

Dimensions

Terminal	Dimensions(mm) with insulating sleeve				
	$d \pm 2$	$L \pm 3$	$L_1 \pm 3$	$d_2 \text{max.}$	$a \pm 0.5$
M5	35	50~120	56.5~126.5	10.3	12.7
M5	51	80~140	86.5~146.5	10.3	22
M5	63.5	80~140	86.5~146.5	10.3	28.6
M5	76.2/89	100~240	106.4~246.5	10.3	31.8
M6	76.2/89	100~240	106.4~246.5	17.5	31.8
M8	100	100~240	110~250	17.5	41.5

Packing

Capacitor diameter d(mm)	length l(mm)	Packing units (pcs.)
35	≤ 70 mm	120
	> 70 mm	60
42	≤ 70 mm	120
	> 70 mm	60
51	≤ 70 mm	70
	> 70 mm	35
63.5	all	24
76.2	all	15
89	all	12
100	all	6

Packing of screw



Accessories

The following items are included in the delivery package, but are not fastened to the capacitors.

	Thread	Maximum torque
For terminals	M5	2 Nm
	M6	2.5 Nm
	M8	5.0 Nm
For mounting	M12	10 Nm

Case Size

WV (Vdc)	Cap (uF)	Size (mm)	Rated Ripple current (Arms/85°C /120Hz)	Typ. ESR 20°C 120Hz (mΩ)	MAX ESR 20°C 120Hz (mΩ)
160	470	35x50	1.1	230	420
160	560	35x50	1.3	200	360
160	680	35x50	1.4	160	290
160	820	35x50	1.5	130	240
160	1000	35x50	1.6	110	200
160	1200	35x60	2.0	94	170
160	1500	35x60	2.2	72	130
160	1800	35x80	2.6	61	110
160	2200	35x80	2.9	50	90
160	2700	35x100	3.4	41	74
160	3300	51x75	3.9	33	60
160	3900	51x75	4.0	28	51
160	4700	51x96	4.7	24	42
160	5600	51x96	5.2	20	36
160	6800	51x120	6.2	16	29
160	6800	63.5x96	6.2	16	29
160	8200	63.5x96	7.1	13	24
160	10000	63.5x120	8.5	11	20
160	10000	76.2x96	8.5	11	20
160	12000	76.2x100	9.5	9.2	17
160	15000	76.2x120	11.5	7.4	13
160	18000	76.2x140	13.5	6.1	11
160	22000	76.2x140	14.0	5.0	9.0
160	22000	89x130	14.8	5.0	9.0
160	27000	89x140	16.1	4.1	7.5
160	33000	89x140	16.6	3.3	7.0
160	47000	89x220	17.5	3.0	6.5
160	68000	100x250	19.3	2	6.0
200	330	35x50	1.0	330	600
200	390	35x50	1.1	280	510
200	470	35x50	1.2	230	420
200	560	35x50	1.4	200	360
200	680	35x50	1.5	160	290
200	820	35x50	1.6	130	240
200	1000	35x60	1.8	110	200
200	1200	35x60	2.1	94	170
200	1500	35x80	2.3	72	130
200	1800	35x80	2.7	61	110
200	2200	35x100	3.1	50	90
200	2200	51x75	3.2	50	90
200	2700	35x120	3.7	41	74
200	2700	51x96	3.7	41	74
200	3300	51x80	4.2	33	60
200	3900	51x100	5.0	28	51
200	4700	51x140	5.8	24	42
200	4700	63.5x96	5.4	24	42
200	5600	63.5x96	5.9	20	36
200	6800	63.5x115	7.0	16	29
200	8200	63.5x120	7.7	13	24
200	10000	76.2x115	9.7	11	20
200	12000	76.2x120	10.3	9	17
200	15000	76.2x140	11.6	7	13
200	15000	89x130	12.3	7	13
200	18000	89x140	13.6	6	11
200	22000	76.2x160	14.0	5.0	9
200	22000	89x140	15.2	5.0	9
200	33000	89x220	16.6	3.5	6
200	47000	89x250	19.9	3.0	5

WV (Vdc)	Cap (uF)	Size (mm)	Rated Ripple current (Arms/85°C /120Hz)	Typ. ESR 20°C 120Hz (mΩ)	MAX ESR 20°C 120Hz (mΩ)
250	270	35x50	0.9	410	740
250	330	35x50	1.1	330	600
250	390	35x50	1.2	280	510
250	470	35x50	1.3	230	420
250	560	35x50	1.5	200	360
250	680	35x60	1.6	160	290
250	820	35x80	1.7	130	240
250	1000	35x80	1.9	110	200
250	1200	35x80	2.2	94	170
250	1500	35x100	2.4	72	130
250	1500	51x75	2.5	72	130
250	1800	35x120	2.8	61	110
250	1800	51x75	2.8	61	110
250	2200	51x96	3.3	50	90
250	2700	51x100	3.8	41	74
250	3300	51x120	4.3	33	60
250	3300	63.5x96	4.3	33	60
250	3900	51x120	5.1	28	51
250	3900	63.5x96	4.7	28	51
250	4700	63.5x115	5.8	24	42
250	5600	63.5x120	6.4	20	36
250	6800	76.2x115	7.8	16	29
250	8200	76.2x120	8.5	13	24
250	10000	76.2x140	10.1	11	20
250	10000	89x140	10.3	11	20
250	12000	89x140	12.0	9	17
250	15000	89x157	12.6	7	13
250	22000	89x220	15.5	5.0	9
250	33000	100x250	17.1	3.3	6
315	180	35x50	0.8	620	1110
315	220	35x50	1.0	500	900
315	270	35x50	1.1	410	740
315	330	35x50	1.2	330	600
315	390	35x50	1.3	280	510
315	470	35x60	1.5	230	420
315	560	35x55	2.5	200	360
315	680	35x65	3.0	160	290
315	820	35x75	3.4	130	240
315	1000	35x80	3.9	110	200
315	1200	35x100	4.6	94	170
315	1500	51x70	5.5	72	130
315	1800	51x75	6.1	61	110
315	2200	51x90	7.3	50	90
315	2700	51x100	8.5	41	74
315	3300	63.5x85	10.0	33	60
315	3900	63.5x96	11.4	28	51
315	4700	76.2x85	13.2	24	42
315	5600	76.2x96	15.1	20	36
315	6800	76.2x110	17.7	16	29
315	8200	89x100	17.8	13	24
315	10000	89x115	20.2	11	20
350	180	35x50	0.9	620	1110
350	220	35x50	1.1	500	900
350	270	35x50	1.2	410	740
350	330	35x50	1.3	330	600
350	390	35x60	1.4	280	510
350	470	35x55	2.3	230	420
350	560	35x60	2.6	200	360

WV (Vdc)	Cap (uF)	Size (mm)	Rated Ripple current (Arms/85°C /120Hz)	Typ. ESR 20°C 120Hz (mΩ)	MAX ESR 20°C 120Hz (mΩ)
350	680	35x70	3.1	160	290
350	820	35x80	3.5	130	240
350	1000	35x90	4.1	110	200
350	1000	51x75	4.3	110	200
350	1200	51x65	4.7	94	170
350	1500	51x75	5.6	72	130
350	1800	51x85	6.5	61	110
350	2200	51x100	7.7	50	90
350	2700	51x105	8.7	41	74
350	2700	63.5x80	8.8	41	74
350	3300	51x130	10.1	33	60
350	3300	63.5x96	10.1	33	60
350	3900	63.5x105	11.2	28	51
350	3900	76.2x80	11.8	28	51
350	4700	63.5x130	12.7	24	42
350	4700	76.2x96	13.3	24	42
350	5600	63.5x130	14.2	20	36
350	5600	76.2x105	15.7	20	36
350	6800	76.2x125	18.7	16	29
350	6800	89x120	18.8	16	29
350	8200	76.2x143	19.0	13	24
350	8200	89x115	18.9	13	24
350	10000	76.2x160	19.5	11	20
350	10000	89x140	21.0	11	20
350	12000	76.2x190	24.8	9	17
350	12000	89x145	25.7	9	17
350	15000	76.2x220	29.1	7	13
350	15000	89x170	29.6	7	13
350	18000	89x200	33.2	6	11
400	180	35x50	1.0	620	1110
400	220	35x50	1.2	500	900
400	270	35x50	1.3	410	740
400	330	35x60	1.5	330	600
400	390	35x55	2.1	280	510
400	470	35x60	2.4	230	420
400	560	35x70	2.8	200	360
400	680	51x80	3.7	160	290
400	820	35x90	3.7	130	240
400	1000	51x65	4.4	110	200
400	1200	51x75	5.0	94	170
400	1500	51x80	5.8	72	130
400	1800	51x96	7.0	61	110
400	2200	51x115	8.1	50	90
400	2200	63.5x85	8.2	50	90
400	2700	51x130	9.4	41	74
400	2700	63.5x96	9.3	41	74
400	3300	63.5x105	10.8	33	60
400	3300	76.2x105	11.3	33	60
400	3900	63.5x118	11.8	28	51
400	3900	76.2x105	12.3	28	51
400	4700	63.5x143	13.5	24	42
400	4700	76.2x105	14.4	24	42
400	4700	89x97	14.9	24	42
400	5600	63.5x195	17.2	20	36
400	5600	76.2x130	15.8	20	36
400	5600	89x96	15.3	20	36
400	6800	76.2x143	19.0	16	29
400	6800	89x115	18.9	16	29
400	8200	76.2x170	20.6	13	24
400	8200	89x130	19.3	13	24

WV (Vdc)	Cap (uF)	Size (mm)	Rated Ripple current (Arms/85°C /120Hz)	Typ. ESR 20°C 120Hz (mΩ)	MAX ESR 20°C 120Hz (mΩ)
400	10000	76.2x190	21.8	11	20
400	10000	89x160	22.0	11	20
400	12000	76.2x220	27.0	9	17
400	12000	89x180	26.0	9	17
400	15000	89x200	29.7	7	13
450	220	35x50	1.2	500	900
450	330	35x55	1.9	330	600
450	390	35x65	2.3	280	510
450	470	35x75	2.6	230	420
450	560	35x80	2.9	200	360
450	680	35x100	3.6	160	290
450	680	51x80	3.8	160	290
450	820	35x110	4.2	130	240
450	1000	51x80	4.7	110	200
450	1200	51x90	5.4	94	170
450	1500	51x90	5.9	72	130
450	1500	51x105	6.8	72	130
450	1500	63.5x80	7.0	72	130
450	1800	51x130	7.8	61	110
450	1800	63.5x96	7.8	61	110
450	2200	63.5x96	8.6	50	90
450	2700	63.5x118	10.2	41	74
450	2700	76.2x96	10.7	41	74
450	3300	63.5x145	11.5	33	60
450	3300	76.2x120	11.0	33	60
450	3300	89x97	13.1	33	60
450	3900	76.2x130	13.4	28	51
450	3900	89x120	14.9	28	51
450	4700	76.2x120	14.5	24	42
450	4700	89x120	16.7	24	42
450	5600	76.2x160	15.9	20	36
450	5600	89x120	15.4	20	36
450	6800	76.2x160	19.1	16	29
450	6800	89x140	19.2	16	29
450	8200	76.2x220	23.1	13	24
450	8200	89x170	23.7	13	24
450	10000	89x200	24.0	11	20
500	330	51x80	2.8	440	800
500	470	51x60	2.7	310	560
500	680	51x80	4.1	220	390
500	820	51x85	4.3	180	320
500	1000	51x105	4.8	150	270
500	1200	51x120	6.0	120	220
500	1200	63.5x85	5.8	120	220
500	1500	51x130	7.0	100	180
500	1500	63.5x96	7.1	100	180
500	1800	63.5x105	7.9	83	150
500	2200	63.5x130	9.4	67	120
500	2200	76.2x96	9.5	67	120
500	2700	63.5x145	10.3	55	98
500	2700	76.2x105	10.8	55	98
500	2700	89x97	11.6	55	98
500	3300	63.5x170	13.0	45	80
500	3300	76.2x130	12.2	45	80
500	3300	89x120	13.4	45	80
500	3900	76.2x145	13.5	38	68
500	3900	89x120	15.0	38	68
500	4700	76.2x170	16.0	31	56
500	4700	89x145	16.8	31	56
500	5600	76.2x220	18.1	26	47

WV (Vdc)	Cap (uF)	Size (mm)	Rated Ripple current (Arms/85°C /120Hz)	Typ. ESR 20°C 120Hz (mΩ)	MAX ESR 20°C 120Hz (mΩ)
500	5600	89x150	17.9	26	47
500	6800	89x170	20.8	22	39
500	8200	89x220	25.6	18	32
500	10000	89x250	30.0	15	27

Useful life

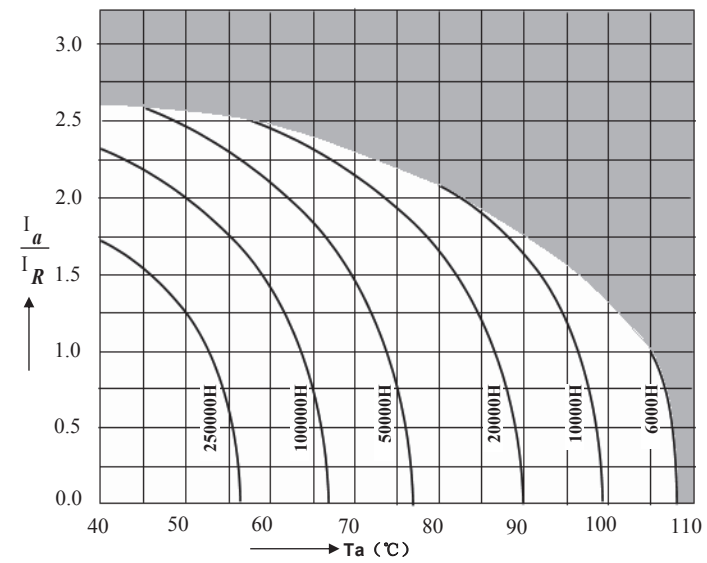

depending on ambient temperature T_a versus under ripple current operating conditions

RH Series 105°C

Features

Standard capacitors

Applications

- ◆ Frequency converters
- ◆ Uninterruptible power supplies
- ◆ Uninterruptible power supplies

Features

- ◆ Outstanding reliability
- ◆ Wide temperature range
- ◆ Extra long useful life
- ◆ Version with low-inductance design available
- ◆ All-welded construction ensures reliable electrical contact
- ◆ Self-extinguishing electrolyte
- ◆ RoHS-compatible

Construction

- ◆ Charge-discharge proof, polar
- ◆ Aluminum case with insulating sleeve
- ◆ Poles with screw terminal connections
- ◆ Mounting with ring clips, clamps or threaded stud



Specifications

Item	Performance Characteristics									
Operating Temperature Range	-40 to +105°C									
Rated voltage V_R	160 to 450 V DC									
Surge voltage V_S	$V_R \leq 315V$ 1.15 V_R $V_R > 315V$ 1.10 V_R									
Rated capacitance C_R	220 to 47000 μF									
Capacitance tolerance	$\pm 20\%$ (120Hz, +20°C)									
Leakage Current I_{leak} (+20°C, max.)	$I_{leak} = 0.018 \times (C \times V)^{0.85} + 4$ or 5mA, whichever is smaller (after 5 minutes) Where, I_{leak} : Max. leakage current (μA), C : Nominal capacitance (μF), V : Rated voltage (V)									
Dissipation Factor ($\tan \delta$, at 20°C, 120Hz)	Less than the value under table(%)									
	<table border="1"> <thead> <tr> <th>Working Voltage(VDC)</th> <th>160~450</th> <th>500~550</th> </tr> </thead> <tbody> <tr> <td>D.F. (%)max.</td> <td>15</td> <td>20</td> </tr> </tbody> </table>	Working Voltage(VDC)	160~450	500~550	D.F. (%)max.	15	20			
Working Voltage(VDC)	160~450	500~550								
D.F. (%)max.	15	20								
Self-inductance ESL	d = 51 mm: approx. 17 nH									
	d \geq 63.5 mm: approx. 20 nH									
Useful life 105°C; $V_R, I_{AC, R}$	Capacitors with low-inductance design: d \geq 63.5 mm: approx. 15 nH									
	Requirements: $\Delta C/C \leq \pm 15\%$ of initial value $\tan \delta \leq 1.75$ times initial specified limit $I_{leak} \leq$ initial specified limit									
Voltage Endurance test 105°C; V_R	2000 h									
	Post test requirements: $\Delta C/C \leq \pm 10\%$ of initial value $\tan \delta \leq 1.3$ times initial specified limit $I_{leak} \leq$ initial specified limit									
Vibration Resistance test	To IEC 60068-2-6, test Fc: Displacement amplitude 0.75 mm, frequency range 10 ... 55 Hz, acceleration max. 10 g, duration 3x2 h. Capacitor mounted by its body which is rigidly clamped to the work surface.									
Characteristics at low temperature	Max. impedance ratio at 120 Hz									
	<table border="1"> <thead> <tr> <th>$V_R(V)$</th> <th>160-450</th> <th>≥ 500</th> </tr> </thead> <tbody> <tr> <td>$Z_{-25^\circ C} / Z_{20^\circ C}$</td> <td>4</td> <td>4</td> </tr> <tr> <td>$Z_{-40^\circ C} / Z_{20^\circ C}$</td> <td>10</td> <td>-</td> </tr> </tbody> </table>	$V_R(V)$	160-450	≥ 500	$Z_{-25^\circ C} / Z_{20^\circ C}$	4	4	$Z_{-40^\circ C} / Z_{20^\circ C}$	10	-
	$V_R(V)$	160-450	≥ 500							
$Z_{-25^\circ C} / Z_{20^\circ C}$	4	4								
$Z_{-40^\circ C} / Z_{20^\circ C}$	10	-								
Sectional specification	IEC 60384-4 and JIS-C-5101									

Multiplier for Ripple Current vs. Frequency

Frequency(Hz)	50	120	300	1K	$\geq 3K$
Multiplier	0.8	1	1.2	1.3	1.4

Dimensional drawings

Ring clip/clamp mounting:

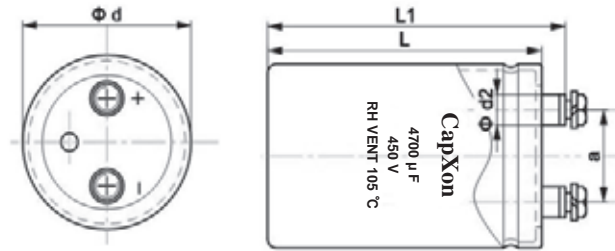

M5:Min.reach of screw = 8mm
 M6:Min.reach of screw = 12mm
 M8:Min.reach of screw = 16mm

Dimensions

Terminal	Dimensions(mm) with insulating sleeve				
	d±2	L±3	L ₁ ±3	d ₂ max.	a±0.5
M5	35	50~120	56.5~126.5	10.3	12.7
M5	51	80~140	86.5~146.5	10.3	22
M5	63.5	80~140	86.5~146.5	10.3	28.6
M5	76.2/89	100~240	106.4~246.5	10.3	31.8
M6	76.2/89	100~240	106.4~246.5	17.5	31.8
M8	100	100~240	110~250	17.5	41.5

Packing

Capacitor diameter d(mm)	length l(mm)	Packing units (pcs.)
35	≤70mm	120
	>70mm	60
42	≤70mm	120
	>70mm	60
51	≤70mm	70
	>70mm	35
63.5	all	24
76.2	all	15
89	all	12
100	all	6

Packing of screw



Accessories

The following items are included in the delivery package, but are not fastened to the capacitors.

	Thread	Maximum torque
For terminals	M5	2 Nm
	M6	2.5 Nm
	M8	5.0 Nm
For mounting	M12	10 Nm

Case Size

WV (Vdc)	Cap (uF)	Size (mm)	Rated Ripple current (Arms/105°C /120Hz)	Typ. ESR 20°C 120Hz (mΩ)	MAX ESR 20°C 120Hz (mΩ)
160	1000	35x60	1.9	110	200
160	1500	35x80	2.5	68	130
160	2200	35x100	3.3	48	90
160	3300	35x120	4.5	32	60
160	3300	51x80	4.5	32	60
160	4700	51x100	5.5	22	42
160	6800	51x140	7.8	15	29
160	6800	63.5x100	7.5	15	29
160	10000	63.5x120	8.8	10	20
160	15000	76.2x120	10.8	7	13
160	22000	76.2x140	13.8	5	9
160	22000	89x130	14.5	5	9
160	33000	89x140	15.5	3	6
160	47000	89x220	19.2	3	5
200	680	35x50	1.4	150	290
200	1000	35x60	2.0	110	200
200	1500	35x80	2.5	68	130
200	2200	35x120	3.6	48	90
200	2200	51x80	3.6	48	90
200	3300	51x80	4.6	32	60
200	3300	51x100	4.8	32	60
200	4700	51x140	6.4	22	42
200	4700	63.5x100	6.2	22	42
200	6800	63.5x120	7.7	15	29
200	10000	76.2x120	10.0	10	20
200	15000	76.2x140	11.5	7	13
200	15000	76.2x160	12.2	7	13
200	22000	76.2x160	15.5	5	9
200	22000	89x140	16.5	5	9
250	470	35x60	1.2	220	420
250	680	35x80	1.7	150	290
250	1000	35x100	2.5	110	200
250	1500	51x80	2.9	68	130
250	2200	51x100	4.0	48	90
250	3300	51x140	5.3	32	60
250	3300	63.5x100	5.0	32	60
250	4700	63.5x120	6.6	22	42
250	6800	76.2x120	8.3	15	29
250	10000	76.2x160	11.0	10	20
250	10000	89x140	11.5	10	20
250	15000	89x170	14.5	7	13
250	22000	89x220	17.0	5	9
350	330	35x60	1.6	320	600
350	470	35x80	2.3	220	420
350	680	35x100	3.3	150	290
350	1000	35x120	4.4	110	200
350	1000	51x80	4.6	110	200
350	1500	51x80	5.7	68	130
350	1500	51x100	6.8	68	130
350	2200	51x105	7.7	48	90
350	2200	51x120	8.3	48	90
350	2200	51x140	8.8	48	90
350	2700	63.5x80	8.7	39	74
350	3300	63.5x100	10.0	32	60
350	3300	63.5x120	10.8	32	60
350	3900	63.5x120	11.5	27	51
350	4700	63.5x145	12.6	22	42
350	4700	76.2x105	12.6	22	42

WV (Vdc)	Cap (uF)	Size (mm)	Rated Ripple current (Arms/105°C /120Hz)	Typ. ESR 20°C 120Hz (mΩ)	MAX ESR 20°C 120Hz (mΩ)
350	4700	76.2x120	13.0	22	42
350	5600	76.2x130	14.8	19	36
350	6800	76.2x140	16.5	15	29
350	8200	76.2x160	20.0	13	24
350	8200	89x145	21.5	13	24
350	10000	76.2x160	21.5	10	20
350	10000	76.2x190	23.0	10	20
350	10000	89x140	23.0	10	20
350	12000	76.2x220	27.5	9	17
350	12000	89x170	28.5	9	17
350	15000	89x190	30.0	7	13
350	18000	89x220	34.0	6	11
400	220	35x50	1.4	470	900
400	330	35x60	1.7	320	600
400	470	35x80	3.3	220	420
400	680	35x120	3.9	150	290
400	680	51x80	4.1	150	290
400	1000	51x80	4.7	110	200
400	1500	51x105	6.4	68	130
400	1500	51x120	7.0	68	130
400	2200	51x130	9.1	48	90
400	2200	63.5x100	8.3	48	90
400	2700	63.5x100	10.0	39	74
400	3300	63.5x130	11.5	32	60
400	3300	76.2x105	11.7	32	60
400	3300	76.2x120	12.2	32	60
400	3900	76.2x120	13.0	27	51
400	4700	76.2x120	14.5	22	42
400	4700	76.2x130	15.0	22	42
400	5600	76.2x145	17.0	19	36
400	6800	76.2x160	19.3	15	29
400	6800	89x145	20.0	15	29
400	8200	89x160	22.0	13	24
400	10000	89x160	24.0	10	20
400	12000	89x180	28.0	9	17
400	15000	89x200	31.0	7	13
450	220	35x50	1.4	470	900
450	330	35x60	1.7	320	600
450	470	35x80	3.5	220	420
450	680	35x120	4.2	150	290
450	680	51x80	5.5	150	290
450	1000	51x80	5.8	110	200
450	1000	51x105	6.5	110	200
450	1500	51x120	7.1	68	130
450	2200	63.5x100	8.4	48	90
450	2200	63.5x120	9.2	48	90
450	2700	63.5x130	11.3	39	74
450	3300	63.5x145	13.2	32	60
450	3300	76.2x120	12.7	32	60
450	3900	76.2x145	15.0	27	51
450	4700	76.2x120	15.0	22	42
450	4700	76.2x160	17.0	22	42
450	5600	76.2x130	16.0	19	36
450	5600	76.2x160	17.8	19	36
450	5600	89x145	20.0	19	36
450	6800	76.2x160	20.0	15	29
450	6800	76.2x220	22.0	15	29
450	6800	89x170	23.0	15	29

WV (Vdc)	Cap (uF)	Size (mm)	Rated Ripple current (Arms/105°C /120Hz)	Typ. ESR 20°C 120Hz (mΩ)	MAX ESR 20°C 120Hz (mΩ)
450	8200	89x180	24.0	13	24
450	10000	89x200	27.0	10	20
450	12000	89x236	29.0	9	17

Useful life

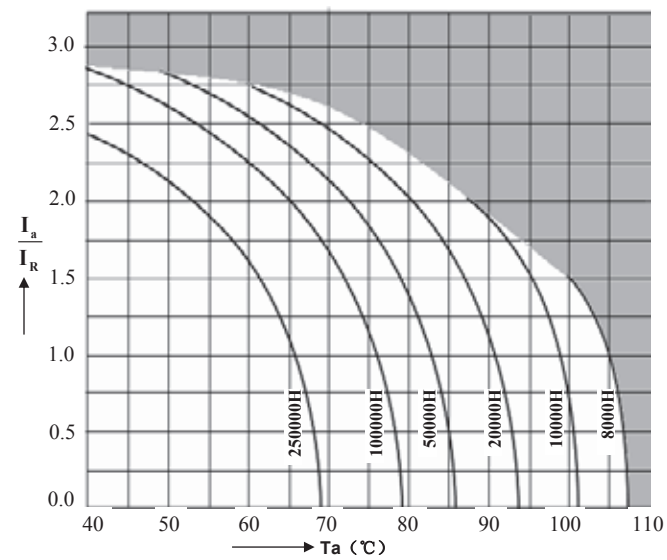

depending on ambient temperature T_a versus under ripple current operating conditions

RQ Series 85°C

Features

Extremely Long useful life

Applications

- ◆ Frequency converters
- ◆ Professional power supplies
- ◆ Hybrid electric vehicles(HEV)
- ◆ Traction

Features

- ◆ Long useful life
- ◆ High reliability
- ◆ Extremely high ripple current capability
- ◆ Wide temperature range
- ◆ All-welded construction ensures reliable electrical contact
- ◆ Low-inductance design
- ◆ Self-extinguishing electrolyte
- ◆ RoHS-compatible

Construction

- ◆ Charge-discharge proof, polar
- ◆ Aluminum case with insulating sleeve
- ◆ Poles with screw terminal connections
- ◆ Mounting with ring clips, clamps or threaded stud



Specifications

Item	Performance Characteristics									
Operating Temperature Range	-40 to +105°C(160Vdc~450Vdc)									
Rated voltage V_R	160 to 450 V DC									
Surge voltage V_S	$V_R \leq 315V$ 1.15 V_R $V_R > 315V$ 1.10 V_R									
Rated capacitance C_R	2200 to 47000 μF									
Capacitance tolerance	$\pm 20\%$ (120Hz, +20°C)									
Leakage Current I_{leak} (+20°C.max.)	$I_{leak} = 0.018 \times (C \times V)^{0.85} + 4$ or 5mA, whichever is smaller (after 5 minutes) Where, I_{leak} : Max. leakage current (μA), C : Nominal capacitance (μF), V : Rated voltage (V)									
Dissipation Factor ($\tan \delta$, at 20°C, 120Hz)	Less than the value under table(%)									
	<table border="1"> <tr> <td>Working Voltage(VDC)</td> <td>160~450</td> </tr> <tr> <td>D.F. (%)max.</td> <td>15</td> </tr> </table>	Working Voltage(VDC)	160~450	D.F. (%)max.	15					
Working Voltage(VDC)	160~450									
D.F. (%)max.	15									
Self-inductance ESL	d = 51 mm: approx. 17 nH									
	d \geq 63.5 mm: approx. 20 nH									
	Capacitors with low-inductance design: d \geq 63.5 mm: approx. 15 nH									
Useful life 105°C; $V_R, I_{AC, R}$	>6000 h									
	Requirements: $\Delta C/C \leq \pm 15\%$ of initial value $\tan \delta \leq 1.75$ times initial specified limit $I_{leak} \leq$ initial specified limit									
Voltage Endurance test 105°C; V_R	2000 h									
	Post test requirements: $\Delta C/C \leq \pm 10\%$ of initial value $\tan \delta \leq 1.3$ times initial specified limit $I_{leak} \leq$ initial specified limit									
Vibration Resistance test	To IEC 60068-2-6, test Fc:									
	Displacement amplitude 0.75 mm, frequency range 10 ... 55 Hz, acceleration max. 10 g, duration 3x2 h. Capacitor mounted by its body which is rigidly clamped to the work surface.									
Characteristics at low temperature	Max. impedance ratio at 120 Hz									
	<table border="1"> <tr> <td>$V_R(V)$</td> <td>160-450</td> <td>≥ 500</td> </tr> <tr> <td>$Z_{-25^\circ C} / Z_{20^\circ C}$</td> <td>4</td> <td>4</td> </tr> <tr> <td>$Z_{-40^\circ C} / Z_{20^\circ C}$</td> <td>10</td> <td>-</td> </tr> </table>	$V_R(V)$	160-450	≥ 500	$Z_{-25^\circ C} / Z_{20^\circ C}$	4	4	$Z_{-40^\circ C} / Z_{20^\circ C}$	10	-
	$V_R(V)$	160-450	≥ 500							
$Z_{-25^\circ C} / Z_{20^\circ C}$	4	4								
$Z_{-40^\circ C} / Z_{20^\circ C}$	10	-								
Sectional specification	IEC 60384-4 and JIS-C-5101									

Multiplier for Ripple Current vs. Frequency

Frequency(Hz)	50	120	300	1K	$\geq 3K$
Multiplier	0.8	1	1.2	1.3	1.4

Screw

Dimensional drawings

Threaded stud mounting

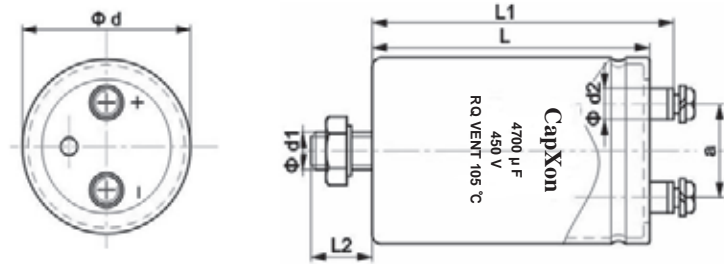

M5:Min.reach of screw = 8mm
 M6:Min.reach of screw = 12mm
 M8:Min.reach of screw = 16mm

Dimensions

Terminal	Dimensions(mm) with insulating sleeve						
	$d \pm 2$	$L \pm 3$	$L_1 \pm 3$	$L_2 + / - 1$	d_1	$d_2 \text{max.}$	$a \pm 0.5$
M5	63.5	80~140	86.5~146.5	16	M12	10.3	28.6
M5/M6	76.2/89	100~240	106.4~246.5	16	M12	10.3	31.8
M5/M6	76.2/89	100~240	106.4~246.5	16	M12	17.5	31.8
M8	100	100~240	110~250	16	M12	17.5	41.5

Packing

Capacitor diameter d(mm)	length l(mm)	Packing units (pcs.)
63.5	all	24
76.2	all	15
89	all	12
100	all	6

Packing of screw



Accessories

The following items are included in the delivery package, but are not fastened to the capacitors.

	Thread	Maximum torque
For terminals	M5	2 Nm
	M6	2.5 Nm
	M8	5.0 Nm
For mounting	M12	10 Nm

Case Size

WV (Vdc)	Cap (uF)	Size (mm)	Rated Ripple current (Arms/105°C /120Hz)	Typ. ESR 20°C 120Hz (mΩ)	MAX ESR 20°C 120Hz (mΩ)
160	6800	63.5x100	11.0	16	29
160	10000	63.5x120	12.5	11	20
160	15000	76.2x120	15.5	7	13
160	22000	76.2x140	20.0	5	9
160	22000	89x130	21.0	5	9
160	33000	89x140	22.0	3	6
160	47000	89x220	28.0	3	5
200	4700	63.5x100	8.8	24	42
200	6800	63.5x120	12.0	16	29
200	10000	76.2x120	13.5	11	20
200	15000	76.2x140	16.0	7	13
200	15000	76.2x160	17.0	7	13
200	22000	76.2x160	22.0	5	9
200	22000	89x140	24.0	5	9
250	3300	63.5x100	7.5	33	60
250	4700	63.5x120	9.5	24	42
250	6800	76.2x120	13.0	16	29
250	10000	76.2x160	15.0	11	20
250	10000	89x140	16.0	11	20
250	15000	89x170	20.0	7	13
250	22000	89x220	24.5	5	9
350	2700	63.5x80	16.0	41	74
350	3300	63.5x100	16.5	33	60
350	3300	63.5x120	17.5	33	60
350	3900	63.5x120	17.7	28	51
350	4700	63.5x145	18.6	24	42
350	4700	76.2x105	22.4	24	42
350	4700	76.2x120	23.0	24	42
350	5600	76.2x130	24.0	20	36
350	6800	76.2x140	26.0	16	29
350	8200	76.2x160	30.0	13	24
350	8200	89x145	34.5	13	24
350	10000	76.2x160	30.5	11	20
350	10000	76.2x190	33.0	11	20
350	10000	89x140	38.4	11	20

WV (Vdc)	Cap (uF)	Size (mm)	Rated Ripple current (Arms/105°C /120Hz)	Typ. ESR 20°C 120Hz (mΩ)	MAX ESR 20°C 120Hz (mΩ)
350	12000	76.2x220	35.0	9	17
350	12000	89x170	37.0	9	17
350	15000	89x190	38.0	7	13
350	18000	89x220	49.0	6	11
400	2200	63.5x100	13.5	50	90
400	2700	63.5x105	16.5	41	74
400	3300	63.5x130	17.5	33	60
400	3300	76.2x105	20.2	33	60
400	3300	76.2x120	21.0	33	60
400	3900	76.2x120	22.2	28	51
400	4700	76.2x120	23.5	24	42
400	4700	76.2x130	24.5	24	42
400	5600	76.2x145	27.0	20	36
400	6800	76.2x160	28.6	16	29
400	6800	89x145	33.0	16	29
400	8200	89x160	35.0	13	24
400	10000	89x160	39.0	11	20
400	12000	89x180	40.0	9	17
400	15000	89x200	42.0	7	13
450	2200	63.5x100	13.0	50	90
450	2200	63.5x120	14.0	50	90
450	2700	63.5x130	16.0	41	74
450	3300	63.5x145	18.5	33	60
450	3300	76.2x120	19.0	33	60
450	3900	76.2x145	22.0	28	51
450	4700	76.2x120	21.0	24	42
450	4700	76.2x160	23.0	24	42
450	5600	76.2x160	23.5	20	36
450	5600	89x145	30.5	20	36
450	6800	76.2x160	26.5	16	29
450	6800	76.2x220	30.5	16	29
450	6800	89x170	39.0	16	29
450	8200	89x180	42.0	13	24
450	10000	89x200	45.0	11	20

Useful life

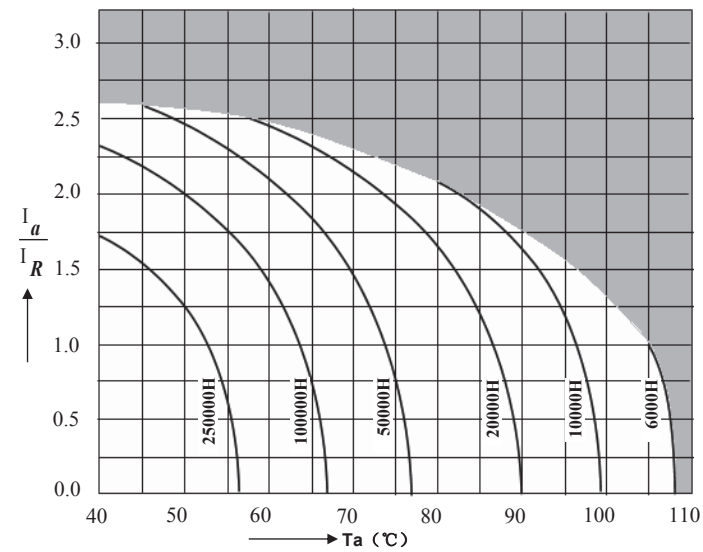

depending on ambient temperature T_a versus under ripple current operating conditions

RT Series 85°C

Features

Extremely Long useful life

Applications

- ◆ Frequency converters
- ◆ Professional power supplies
- ◆ Traction

Features

- ◆ Outstanding reliability
- ◆ Extra long useful life
- ◆ Wide temperature range
- ◆ Version with low-inductance design available
- ◆ All-welded construction ensures reliable electrical contact
- ◆ Self-extinguishing electrolyte
- ◆ RoHS-compatible

Construction

- ◆ Charge-discharge proof, polar
- ◆ Aluminum case with insulating sleeve
- ◆ Poles with screw terminal connections
- ◆ Mounting with ring clips, clamps or threaded stud



Specifications

Item	Performance Characteristics	
Operating Temperature Range	-40 to +105°C(160Vdc~450Vdc)	
Rated voltage V_R	160 to 450 V DC	
Surge voltage V_S	$V_R \leq 315V$ 1.15 V_R $V_R > 315V$ 1.10 V_R	
Rated capacitance C_R	2200 to 47000 μF	
Capacitance tolerance	$\pm 20\%$ (120Hz,+20°C)	
Leakage Current I_{leak} (+20°C,max.)	$I_{leak} = 0.018 \times (C \times V)^{0.85} + 4$ or 5mA, whichever is smaller (after 5 minutes) Where, I_{leak} : Max. leakage current (μA), C : Nominal capacitance (μF), V : Rated voltage (V)	
Dissipation Factor ($\tan \delta$, at 20°C, 120Hz)	Less than the value under table(%)	
	Working Voltage(VDC)	160~450
	D.F. (%)max.	15
Self-inductance ESL	d = 51 mm: approx. 17 nH	
	d \geq 63.5 mm: approx. 20 nH	
	Capacitors with low-inductance design:	
	d \geq 63.5 mm: approx. 15 nH	
Useful life 105°C; $V_R, I_{AC,R}$	>8000 h	Requirements:
		$\Delta C/C \leq \pm 15\%$ of initial value $\tan \delta \leq 1.75$ times initial specified limit $I_{leak} \leq$ initial specified limit
Voltage Endurance test 105°C; V_R	2000 h	Post test requirements:
		$\Delta C/C \leq \pm 10\%$ of initial value $\tan \delta \leq 1.3$ times initial specified limit $I_{leak} \leq$ initial specified limit
Vibration Resistance test	To IEC 60068-2-6, test Fc: Displacement amplitude 0.75 mm, frequency range 10 ... 55 Hz, acceleration max. 10 g, duration 3x2 h. Capacitor mounted by its body which is rigidly clamped to the work surface.	
Characteristics at low temperature	Max. impedance ratio at 120 Hz	
	$V_R(V)$	160-450 ≥ 500
	$Z_{-25^\circ C} / Z_{20^\circ C}$	4 4
	$Z_{-40^\circ C} / Z_{20^\circ C}$	10 -
Sectional specification	IEC 60384-4 and JIS-C-5101	

Screw

Multiplier for Ripple Current vs. Frequency

Frequency(Hz)	50	120	300	1K	$\geq 3K$
Multiplier	0.8	1	1.2	1.3	1.4

Dimensional drawings

Threaded stud mounting

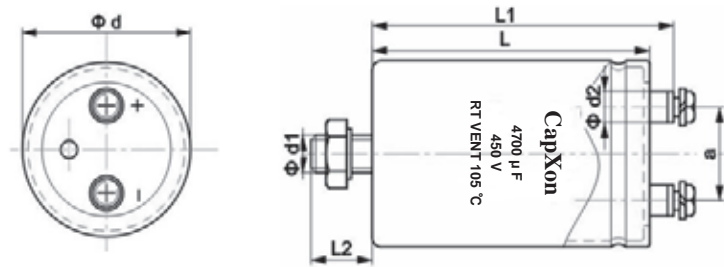

M5:Min.reach of screw = 8mm
 M6:Min.reach of screw = 12mm
 M8:Min.reach of screw = 16mm

Dimensions

Terminal	Dimensions(mm) with insulating sleeve						
	$d \pm 2$	$L \pm 3$	$L_1 \pm 3$	$L_2 + / - 1$	d_1	$d_2 \text{max.}$	$a \pm 0.5$
M5	63.5	80~140	86.5~146.5	16	M12	10.3	28.6
M5/M6	76.2/89	100~240	106.4~246.5	16	M12	10.3	31.8
M5/M6	76.2/89	100~240	106.4~246.5	16	M12	17.5	31.8
M8	100	100~240	110~250	16	M12	17.5	41.5

Packing

Capacitor diameter d(mm)	length l(mm)	Packing units (pcs.)
63.5	all	24
76.2	all	15
89	all	12
100	all	6

Packing of screw

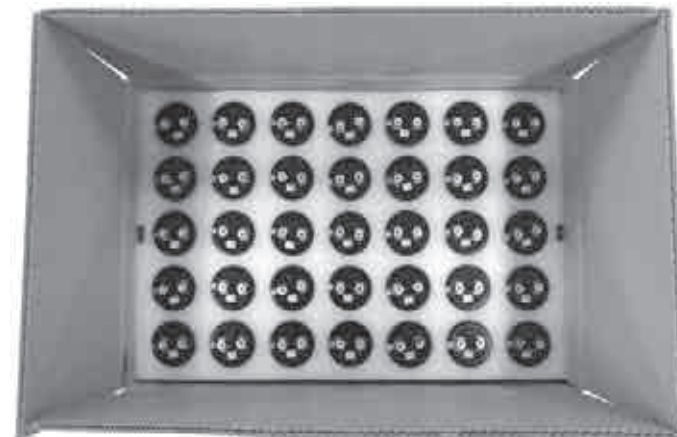

Accessories

The following items are included in the delivery package, but are not fastened to the capacitors.

	Thread	Maximum torque
For terminals	M5	2 Nm
	M6	2.5 Nm
	M8	5.0 Nm
For mounting	M12	10 Nm

Case Size

WV (Vdc)	Cap (uF)	Size (mm)	Rated Ripple current (Arms/105°C /120Hz)	Typ. ESR 20°C 120Hz (mΩ)	MAX ESR 20°C 120Hz (mΩ)
160	6800	63.5x100	12.0	15	29
160	10000	63.5x120	13.8	10	20
160	15000	76.2x120	17.0	7	13
160	22000	76.2x140	22.0	5	9
160	22000	89x130	23.0	5	9
160	33000	89x140	24.0	3	6
160	47000	89x220	31.0	3	5
200	4700	63.5x100	9.7	22	42
200	6800	63.5x120	13.5	15	29
200	10000	76.2x120	15.0	10	20
200	15000	76.2x140	17.5	7	13
200	15000	76.2x160	18.5	7	13
200	22000	76.2x160	24.0	5	9
200	22000	89x140	26.0	5	9
250	3300	63.5x100	8.3	32	60
250	4700	63.5x120	10.5	22	42
250	6800	76.2x120	14.5	15	29
250	10000	76.2x160	16.5	10	20
250	10000	89x140	17.5	10	20
250	15000	89x170	22.0	7	13
250	22000	89x220	27.0	5	9
350	2700	63.5x80	17.5	39	74
350	3300	63.5x100	18.0	32	60
350	3300	63.5x120	19.0	32	60
350	3900	63.5x120	19.5	27	51
350	4700	63.5x145	20.5	22	42
350	4700	76.2x105	24.6	22	42
350	4700	76.2x120	25.5	22	42
350	5600	76.2x130	26.5	19	36
350	6800	76.2x140	28.5	15	29
350	8200	76.2x160	33.0	13	24
350	8200	89x145	39.0	13	24
350	10000	76.2x160	33.5	10	20
350	10000	76.2x190	36.0	10	20
350	10000	89x140	42.0	10	20

WV (Vdc)	Cap (uF)	Size (mm)	Rated Ripple current (Arms/105°C /120Hz)	Typ. ESR 20°C 120Hz (mΩ)	MAX ESR 20°C 120Hz (mΩ)
350	12000	76.2x220	38.0	9	17
350	12000	89x170	40.0	9	17
350	15000	89x190	42.0	7	13
350	18000	89x220	51.0	6	11
400	2200	63.5x100	14.8	48	90
400	2700	63.5x105	18.2	39	74
400	3300	63.5x130	19.3	32	60
400	3300	76.2x105	22.0	32	60
400	3300	76.2x120	23.0	32	60
400	3900	76.2x120	24.0	27	51
400	4700	76.2x120	25.8	22	42
400	4700	76.2x130	27.0	22	42
400	5600	76.2x145	30.0	19	36
400	6800	76.2x160	31.5	15	29
400	6800	89x145	36.0	15	29
400	8200	89x160	38.5	13	24
400	10000	89x160	43.0	10	20
400	12000	89x180	44.0	9	17
400	15000	89x200	46.0	7	13
450	2200	63.5x100	15.0	48	90
450	2200	63.5x120	16.0	48	90
450	2700	63.5x130	18.5	39	74
450	3300	63.5x145	21.5	32	60
450	3300	76.2x120	22.0	32	60
450	3900	76.2x145	25.5	27	51
450	4700	76.2x120	24.3	22	42
450	4700	76.2x160	26.5	22	42
450	5600	76.2x160	27.3	19	36
450	5600	89x145	35.0	19	36
450	6800	76.2x160	30.7	15	29
450	6800	76.2x220	35.0	15	29
450	6800	89x170	45.0	15	29
450	8200	89x180	48.0	13	24
450	10000	89x200	50.0	10	20

Useful life

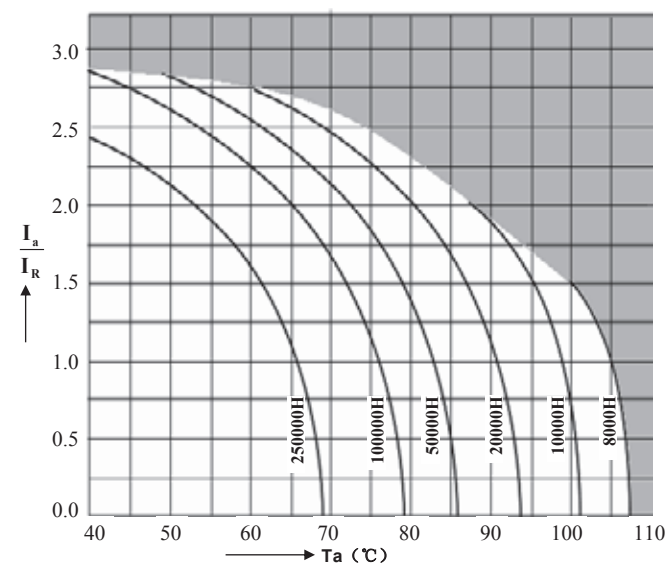

depending on ambient temperature T_a versus under ripple current operating conditions

Disclaimer

1. Specification and description for the component(s) are subject to change without notice.
 2. Operation conditions (ambient temperature, ripple current, thermal resistance, etc.) may affect the lifetime of a capacitor, please consult Capxon for life time calculation in your application.
 3. For aerospace or military application and for life-saving or life-sustaining applications please consult us before design-in in your application.
 4. Under no circumstance, Capxon warrants that any Capxon product is suitable for the purposes intended for your application, even Capxon knows the application It is buyer's duty and obligation to check and make sure that Capxon's products are suitable for the purposes intended and select the correct and proper Capxon product.
 5. Except for the written express warranties, Capxon DO NOT, impliedly, by assumption or whatever else, warrant, undertake, promise any other warranty or guaranty for Capxon's Products.
1. 零件的規格和說明如有更改，恕不另行通知。
 2. 操作條件（環境溫度、紋波電流、熱阻等）可能會影響電容器的壽命，您應用的壽命計算請諮詢 Capxon。
 3. 對於航太或軍事應用以及安全維持生命的應用，在您導入設計應用之前請向本公司諮詢。
 4. 在任何情況下，Capxon不保證任何Capxon產品符合您應用之預期目的，即使Capxon知悉該應用。檢查並確保Capxon產品符合預期目的以及選擇正確和適當的Capxon產品是買方的義務。
 5. 除書面明示保證外，Capxon對於Capxon產品不以假設或任何其他方式暗示保證、承擔、承諾任何其他保證或擔保。

Contact us for any question on usage of our products inside your application, like safety, lifetime, reliability or assembling and mounting.
Please refer to the guidelines inside this catalogue and the disclaimer.
For further information visit our website: www.capxongroup.com



<http://www.capxongroup.com>

CapXon
Professional

ELECTROLYTIC CAPACITORS

2018/2019

CapXon
Catalog 2018/2019
Aluminum Electrolytic Capacitors



AEC-Q200
IATF 16949

CapXon

英屬維京群島商凱普松科技股份有限公司
台灣分公司
Capxon Technology Limited Taiwan Branch
新北市汐止區大同路二段157號5樓
5F, No. 157, Da Tung Road, Sec. 2, XiZhi Dist.,
New Taipei City, 22183, Taiwan R. O. C.
TEL : +886-2-8692-6611 FAX : +886-2-8692-6477 / 8692-6481
E-mail: sales@capxon.com.tw

英屬維京群島商凱普松科技股份有限公司
台灣分公司－歐洲辦事處
Capxon Europe Office
Schwalbenweg 11, 72793 Pfullingen, Germany
TEL : +49-151-11355795
E-mail: sales@capxon-europe.com

豐賓電子（深圳）有限公司
Capxon Electronic (Shen-Zhen) Co., Ltd.
518106 廣東省深圳市光明新區公明街道塘尾社區松白路4132號(塘尾工業區)
No.4132, Songbai Road, Tangwei Village, Gongming Sub-district, Guangming
New District, Shenzhen City, Guangdong, China
Post Code : 518106
TEL : +86-755-2717-7888 FAX : +86-755-2717-7802
E-mail: sales@capxon.com.cn

豐賓電子（深圳）有限公司－蘇州辦事處
Capxon Electronic (Shen-Zhen) Co., Ltd. – Su-Zhou Office
江蘇省蘇州市高新區錦峰路158號3樓
Room 301-2, Building 22, NO.158 Jinfeng Road, High-tech Zone, Suzhou, China
TEL : +86-0512-68780980 FAX : +86-512-68780981
E-mail: sales@capxon.com.cn

* 本商品目錄所記載的內容，可能會在沒有預先通知的情況下發生更改，敬請諒解。
* Specifications subject to change without notice

Aluminum Electrolytic Capacitors
Conductive Polymer Capacitors
Conductive Hybrid Capacitors

X-ON Electronics

Largest Supplier of Electrical and Electronic Components

Click to view similar products for [Aluminium Electrolytic Capacitors - Radial Leaded](#) category:

Click to view products by [Capxon](#) manufacturer:

Other Similar products are found below :

[NRELS102M35V16X16C.140LLF](#) [ESRG160ETC100MD07D](#) [227RZS050M](#) [335CKR250M](#) [476CKH100MSA](#) [477CKR100M](#)
[107CKR010M](#) [107CKH063MSA](#) [RJH-25V222MI9#](#) [RJH-35V221MG5#](#) [B43827A1106M8](#) [RJH-50V221MH6#](#) [EKYA500ELL470MF11D](#)
[B41022A5686M6](#) [ESRG250ELL101MH09D](#) [EKMA160EC3101MF07D](#) [RJB-10V471MG3#](#) [ESMG160ETD221MF11D](#)
[EKZH160ETD152MJ20S](#) [RJH-35V122MJ6#](#) [EGXF630ELL621ML20S](#) [RBD-25V100KE3#N](#) [EKMA350ELL100ME07D](#)
[ESMG160ETD101ME11D](#) [ELXY100ETD102MJ20S](#) [EGXF500ELL561ML15S](#) [EKMG350ETD471MJ16S](#) [35YXA330MEFC10X12.5](#)
[RXW471M1ESA-0815](#) [ELXZ630ELL221MJ25S](#) [ERR1HM1R0D11OT](#) [LPE681M30060FVA](#) [LPL471M22030FVA](#) [HFE221M25030FVA](#)
[LKMD1401H221MF](#) [B41888G6108M000](#) [EKMA160ETD470MF07D](#) [UHW1J102MHD6](#) [EKMG500ETD221MJC5S](#) [LKMK2502W101MF](#)
[LKMD1401H181MF](#) [LKMI2502G820MF](#) [LKMJ2001J122MF](#) [LKML2501C472MF](#) [LKMJ4002C681MF](#) [450MXH330MEFCSN25X45](#)
[450MXK330MA2RFC22X50](#) [63ZLH560MEFCG412.5X30](#) [ELH2DM331O25KT](#) [ELH2DM471P30KT](#)