

# 2M-Series

## MINIATURE TOGGLES

The 2M family of miniature toggle switches is composed of three switch series; the **2M1-Series** miniature toggle switch, the **2MS-Series** sealed miniature toggle switch, and the **2M1H-Series** premium sealed miniature toggle switch. These series all feature PC mounting and offer a variety of ratings, circuits, contact materials, terminal platings, toggle styles and lengths, and optional color caps.

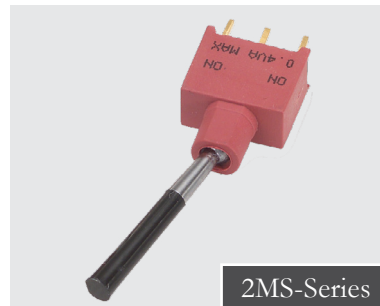

### Product Highlights:

- IP67 Sealing
- 8 Single and Double Pole Circuits
- Long, Short and Flatted Bushing Options
- Large Variety of Termination Options
- Available Gold, Silver and Tin Platings
- UL Approved
- Sleek Black Finish

### Typical Applications:

- Telecommunications
- Instrumentation
- Networking
- Medical Equipment
- Military Communications

### Resources:

[Configure a Complete Part](#)

[Download CAD & Sales Drawing >](#)



**Carling Technologies®**

Innovative Designs. Powerful Solutions.

**Carling Technologies, Inc.**  
60 Johnson Avenue, Plainville, CT 06062  
Email: [sales@carlingtech.com](mailto:sales@carlingtech.com)  
Application Support: [team2@carlingtech.com](mailto:team2@carlingtech.com)  
Phone: 860.793.9281 Fax: 860.793.9231

[www.carlingtech.com](http://www.carlingtech.com)



**2M1H-Series**  
Premium Sealed  
Miniature  
Toggle Switch

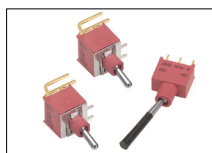

**2MS-Series**  
Sealed  
Miniature  
Toggle Switch



**2M1-Series**  
Miniature  
Toggle Switch

### Electrical

Contact Rating	refer to ordering scheme
Electrical Life	50,000 make & break cycles @ full load
Contact Resistance	10 mΩ max. initial @ 2-4 VDC 100mA for both silver & gold plated contacts
Insulation Resistance	1000 MΩ min.
Dielectric Strength	1500 Volts RMS @ sea level

### Physical

Operating Temperature	-30°C to +85°C
Index of Protection	<i>2M1H-Series:</i> IP67 <i>2MS-Series:</i> IP67
Solder Heat Resistance	MIL-STD-202, Method 210
Actuator Travel	25°

### Material

Case	<i>2M1H-Series &amp; 2M1-Series:</i> Diallyl phthalate (DAP) (UL 94V-0) <i>2MS-Series:</i> Glass filled nylon 6/6, flame retardant, heat stabilized (UL 94V-0)
Toggle	<i>2M1H-Series:</i> Brass, black finish with o-ring seal <i>2MS-Series:</i> Brass, chrome plated, internal o-ring sealed <i>2M1-Series:</i> Brass, chrome plated
Bushing	<i>2M1H-Series:</i> Brass, black finish with o-ring seal <i>2MS-Series:</i> Glass filled nylon 6/6, flame retardant, heat stabilized (UL 94V-0) <i>2M1-Series:</i> Brass, nickel plated
Housing	Stainless Steel
Bracket	<i>2MS-Series:</i> Nylon (UL 94V-0) <i>2M1-Series:</i> Stainless Steel
Actuator Pivot Retainer	<i>2MS-Series:</i> Stainless Steel
Switch Support	Brass, tin plated
Terminal Seal	Epoxy

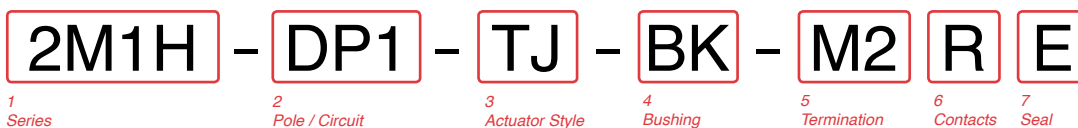

<b>1 SERIES</b>
<b>2M1H</b> Premium Sealed Miniature Toggle Switch

<b>2 POLE / CIRCUIT</b>		
() - momentary		
<b>Position:</b>	<b>1</b>	<b>2</b>
	2-3, 5-6	Connected Terminals
<b>SP1</b>	ON	NONE
<b>SP2</b>	ON	NONE
<b>SP3</b>	ON	OFF
<b>SP4</b>	(ON)	OFF
<b>SP5</b>	ON	OFF
<b>DP1</b>	ON	NONE
<b>DP2</b>	ON	NONE
<b>DP3</b>	ON	OFF
<b>DP4</b>	(ON)	OFF
<b>DP5</b>	ON	OFF
<b>DP6 *</b>	ON	ON
<b>DP7 *</b>	(ON)	ON
<b>DP8 *</b>	ON	ON

\*Center position connects 2-3, 5-4

<b>3 ACTUATOR STYLE</b>	
<b>TJ</b> .709" [18 mm] length	<b>TK</b> .512" [13.00 mm] length

<b>4 BUSHING</b>	
<b>BK</b> .386" [9.80 mm] threaded, flat	

<b>5 TERMINATION <sup>7</sup></b>		<b>M51</b> Wire Wrap, .750" [19.05mm] length
<b>M1</b> Solder Lug	<b>M52</b> Wire Wrap, .964" [24.48mm] length	
<b>M2</b> PCB	<b>M53</b> Wire Wrap, .425" [10.80mm] length	
<b>M3</b> Quick Connect	<b>M54</b> Wire Wrap, 1.062" [25.97mm] length	

<b>6 CONTACTS / TERMINALS</b>				
	<b>Contact Material</b>	<b>Terminal Plating</b>	<b>Rating</b>	<b>Approvals</b>
<b>G</b>	silver <sup>1</sup>	gold over silver	5A 125VAC or 28VDC, 2A 250VAC	IP67
<b>K</b>	gold <sup>2,5</sup>	tin <sup>4,7</sup>	0.4VA max 20V max (AC/DC)	IP67
<b>P</b>	silver <sup>1,6</sup>	tin <sup>4,7</sup>	5A 125VAC or 28VDC, 2A 250VAC	IP67
<b>Q</b>	silver <sup>1</sup>	silver <sup>1</sup>	5A 125VAC or 28VDC, 2A 250VAC	IP67
<b>R</b>	gold <sup>2</sup>	gold <sup>3</sup>	0.4VA max 20V max (AC/DC)	IP67

<b>7 EPOXY SEAL</b>	
<b>E</b> Epoxy Seal	

- Notes:
- Switches supplied with (1) 2M1-HDW4 hex nut and (1) 3MNH-WCP-0872 O-Ring
  - 1 Movable contact and terminal platings: silver over copper alloy
  - 2 Movable contact and terminal platings: gold over nickel over copper alloy
  - 3 Terminal platings: gold over nickel over copper alloy
  - 4 Terminal platings: tin over copper alloy
  - 5 Terminal contact platings: gold over nickel alloy
  - 6 Terminal contact platings: silver over nickel alloy
  - 7 Tin option not available with M1 & M3 terminations.

\*Manufacturer reserves the right to change product specification without prior notice.

# 2MS - WSP 1 - T1 - B4 - M1 G E

1 Series      2 Poles      3 Circuit      4 Actuator Style      5 Bushing      6 Termination      7 Contacts      8 Seal

### 1 SERIES

**2MS** Sealed Miniature Toggle Switch

### 2 POLES

**WSP** Single pole - uses terminals 1, 2 & 3  
**WDP** Double pole - uses terminals 1, 2, 3, 4, 5 & 6  
**W3P** Three pole - uses terminals 1, 2, 3, 4, 5, 6, 7, 8 & 9

### 3 CIRCUIT

( ) - momentary

Position:	1	2	3
	2-3, 5-6, 8-9	Connected Terminals	2-1, 5-4, 8-7
1	ON	NONE	ON
2	ON	NONE	(ON)
3	ON	OFF	ON
4	(ON)	OFF	(ON)
5	ON	OFF	(ON)

### 4 ACTUATOR STYLE

**T1** Round Bat      **T9** Long Black Plastic .492" length  
**T2** Round Short Bat      **P1** Plastic Anti-Static .496" length  
**P2** Plastic Anti-Static .299" length



### 5 BUSHING

**B1** Threaded, Keyway      **B4** Unthreaded, Short, Keyway, Flat

### 6 TERMINATION

<b>M1</b> <sup>4</sup>	Solder Lug	<b>VS21</b>	Vertical, Snap-In, .460" [11.70mm]
<b>M2</b>	PCB	<b>VS3</b>	Vertical, .630" [16mm]
<b>M3</b>	Quick Connect	<b>VS31</b>	Vertical, Snap-In, .630" [16mm]
<b>M51</b>	Wire Wrap, .750" [19.05mm]	<b>U2</b>	Vertical, .551" [14mm] - only 3PDT
<b>M52</b>	Wire Wrap, .964" [24.48mm]	<b>VS4</b>	Vertical, .461" [11.70mm]
<b>M53</b>	Wire Wrap, .425" [10.80mm]	<b>VS41</b>	Vertical, Snap-In, .461" [11.70mm]
<b>M54</b>	Wire Wrap, 1.062" [25.97mm]	<b>U4</b>	Vertical, .551" [14mm] - only 3PDT
<b>M6</b>	Right Angle, PC Thru-Hole	<b>VS5</b>	Vertical, .630" [16mm]
<b>M61</b>	Right Angle, Snap-In	<b>VS51</b>	Vertical, Snap-In, .630" [16mm]
<b>M7</b>	Vertical, Right Angle, PC Thru-Hole		
<b>M71</b>	Vertical, Right Angle, Snap-In		
<b>VS2</b>	Vertical, .461" [11.70mm]		

### 7 CONTACTS / TERMINALS

	Contact Material	Terminal Plating	Rating	Approvals
<b>G</b>	silver <sup>1</sup>	gold over silver	5A 125VAC or 28VDC, 2A 250VAC	e <sup>2</sup>  us, IP67
<b>K</b>	gold <sup>2</sup>	tin <sup>3,4</sup>	0.4VA max 20V max (AC/DC)	IP67
<b>P</b>	silver <sup>1</sup>	tin <sup>3,4</sup>	5A 125VAC or 28VDC, 2A 250VAC	e <sup>2</sup>  us, IP67
<b>R</b>	gold <sup>2</sup>	gold <sup>2</sup>	0.4VA max 20V max (AC/DC)	IP67

### 8 EPOXY SEAL

**E** Epoxy Seal      **0** without Epoxy Seal

#### Notes:

- B1 Bushing switches supplied with (2) 2M1-HDW2 nuts, (1) 2M1-HDW11 washer and (1) 2M1-HDW15 locking ring. See page 76-77.  
 1 Movable contact & terminal platings: silver over copper alloy  
 2 Movable contact & terminal platings: gold over nickel over copper alloy  
 3 Terminal platings: tin over nickel over copper alloy  
 4 Tin option not available with M1 terminal

# 2M1 - SP 1 - T1 - B1 - M1 Q E

1 Series      2 Poles      3 Circuit      4 Actuator Style      5 Bushing      6 Termination      7 Contacts      8 Seal

### 1 SERIES

**2M1** Miniature Toggle Switch

### 2 POLES

**SP** Single pole - uses terminals 1, 2 & 3  
**DP** Double pole - uses terminals 1, 2, 3, 4, 5 & 6  
**3P** Three pole - uses terminals 1, 2, 3, 4, 5, 6, 7, 8 & 9  
**4P** Four pole - uses terminals 1, 2, 3, 4, 5, 6, 7, 8, 9, 10, 11 & 12

### 3 CIRCUIT

( ) - momentary

Position:	1	2	3
	2-3, 5-6, 8-9, 11-12	Connected Terminals	2-1, 5-4, 8-7, 11-10
1	ON	NONE	ON
2	ON	NONE	(ON)
3	ON	OFF	ON
4	(ON)	OFF	(ON)
5	ON	OFF	(ON)
6*	ON	ON	ON
7*	(ON)	ON	(ON)
8*	ON	ON	(ON)

\*Available with DP and 4P switches only. Center position connects 2-3, 5-4, 8-9, 11-10

### 4 ACTUATOR STYLE

**T1** Round Bat      **T7** Large Bat (B0 bushing)  
**T2** Round Short Bat      **T8** X-Large Bat (B0 bushing)  
**T3** Paddle      **T9** Black Plastic  
**T4** Medium Paddle      **T0** Rectangular  
**T5** Long Paddle      **TA** Locking Lever  
**T6** Flat (B1,B2,B5,BA,BB,BE)      **TI** Locking Lever  
**TL** Locking Lever







### 5 BUSHING

**B1** Threaded Standard, keyway      **B8** Metric  
**B2** Non-Threaded Standard, keyway      **B9** Splashproof  
**B3** Threaded Short, keyway      **B0** 15/32" Threaded (Standard for T7 & T8 actuator styles)  
**B4** Non-Threaded Short, keyway      **BA** Threaded for T6  
**B5** High Torque, 7.5mm, flat      **BB** Non-Threaded for T6  
**B6** High Torque, 8.0mm, keyway      **BE** Threaded Hi Torque for T6  
**B7** Long threaded      **BL** Threaded, Locking

### 6 TERMINATION

<b>M1</b> <sup>4</sup>	Solder Lug	<b>M71</b>	Vertical, Right Angle, Snap-In
<b>M2</b>	PCB	<b>VS2</b>	Vertical, .461" [11.70mm]
<b>M3</b>	Quick Connect	<b>VS21</b>	Vertical, Snap-In, .461" [11.70mm]
<b>M51</b>	Wire Wrap, .750" [19.05mm]	<b>VS3</b>	Vertical, .630" [16mm]
<b>M52</b>	Wire Wrap, .964" [24.48mm]	<b>VS31</b>	Vertical, Snap-In, .630" [16mm]
<b>M53</b>	Wire Wrap, .425" [10.80mm]	<b>VS4</b>	Vertical, .461" [11.70mm]
<b>M54</b>	Wire Wrap, 1.062" [25.97mm]	<b>VS41</b>	Vertical, Snap-In, .461" [11.70mm]
<b>M6</b>	Right Angle, PC Thru-Hole	<b>VS5</b>	Vertical, .630" [16mm]
<b>M61</b>	Right Angle, Snap-In	<b>VS51</b>	Vertical, Snap-In, .630" [16mm]
<b>M7</b>	Vertical, Right Angle, PC Thru-Hole		

### 7 CONTACTS / TERMINALS

	Contact Material	Terminal Plating	Rating	Approvals
<b>G</b>	silver <sup>1</sup>	gold over silver	5A 125VAC or 28VDC, 2A 250VAC	  IP67
<b>K</b>	gold <sup>2</sup>	tin <sup>3,4</sup>	0.4VA max 20V max (AC/DC)	N/A
<b>P</b>	silver <sup>1</sup>	tin <sup>3,4</sup>	5A 125VAC or 28VDC, 2A 250VAC	  IP67
<b>Q</b>	silver <sup>1</sup>	silver <sup>1</sup>	5A 125VAC or 28VDC, 2A 250VAC	  IP67
<b>R</b>	gold <sup>2</sup>	gold <sup>2</sup>	0.4VA max 20V max (AC/DC)	N/A

### 8 EPOXY SEAL

**E** Epoxy Seal      **0** without Epoxy Seal

#### Notes:

- B1 Bushing switches supplied with (2) 2M1-HDW2 nuts, (1) 2M1-HDW11 washer and (1) 2M1-HDW15 locking ring.  
 1 Movable contact & terminal platings: silver over copper alloy  
 2 Movable contact & terminal platings: gold over nickel over copper alloy  
 3 Terminal platings: tin over nickel over copper alloy  
 4 Tin option not available with M1 terminal

**2M-Series Accessories**

To order accessories assembled on a switch, specify the switch number followed by the accessory part number and the word "assembled". Ex: 2M1-SP1-T1-B1-M1QE-T12 ASSEMBLED. To order accessories in bulk, specify the Series, followed by the accessory. Ex: 2M1-T12. See page 76 for dimensional specifications.

**Optional Toggle Cap**

**2M1** - **T1** **2**

<sup>1</sup> Series                      <sup>2</sup> Toggle Cap Size                      <sup>3</sup> Color

**1 SERIES**  
**2M1** Fits 2M1H, 2MS or 2M1

**3 CAP COLOR**

<b>1</b> White	<b>5</b> Yellow
<b>2</b> Black	<b>6</b> Green
<b>3</b> Red	<b>7</b> Blue

**2 TOGGLE CAP SIZE**  
**T1** 10.6 mm                      **T2** 7.6 mm

**Optional Dress and Knurled Nuts**

**2M1** - **HDW3**

<sup>1</sup> Series                      <sup>2</sup> Nut

**1 SERIES**  
**2M1** Fits 2M1H, 2MS or 2M1

**2 NUT**  
**HDW3** Dress nut for 1/4" bushing  
**HDW5** Knurled nut for 15/32" bushing (2M1-Series only)

**Optional Rubber Seals**

**2M1** - **E1A**

<sup>1</sup> Series                      <sup>2</sup> Rubber Boot Seal

**1 SERIES**  
**2M1** Fits 2M1H, 2MS or 2M1

**2 RUBBER BOOT SEAL**  
**E1A** 1/4 - 40" UNS bushing (Not available for B0 bushing option)  
**K1** Metric M6 bushing (B8 bushing only)  
**YE1D** 15/32 - 32" UNS bushing (TJ, TK and B0 bushings only)  
**YE1E** 15/32 - 32" UNS bushing 1/2 boot (T7, T8, TJ, TK and B0 bushings only)

**3MNH** - **WCP-0872**

<sup>1</sup> Series                      <sup>2</sup> Rubber O-Ring

**1 SERIES**  
**3MNH** Fits 3MNH or 2M1H

**2 RUBBER O-RING**  
**WCP-0872** For 15/32 bushing option

## 2M1H-Series Dimensional Specifications: in. [mm]

### Single Pole

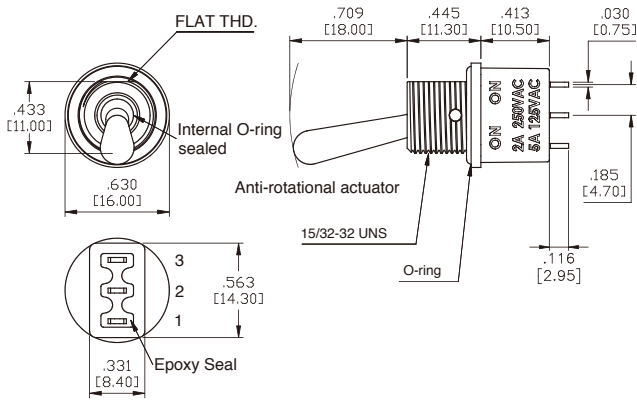

### Double Pole

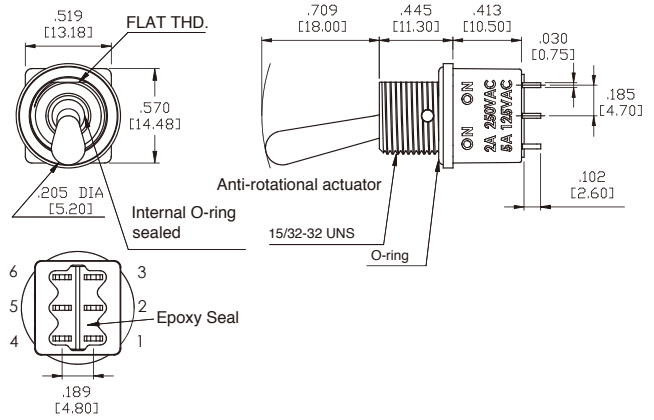

### Actuator Options

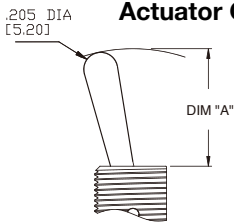

OPTION CODE	DIM. "A"
TJ	.709 [18.00]
TK	.512 [13.00]

### Bushing Options & Mounting

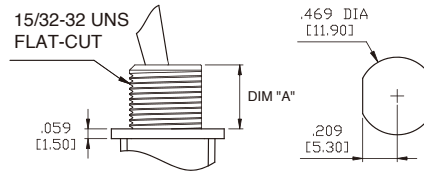

OPTION CODE	DIM. "A"
BK	.386 [9.80]

### Termination Options

#### M1 Standard Solder Lug

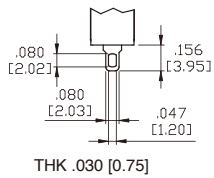

#### M2 PC Thru-Hole

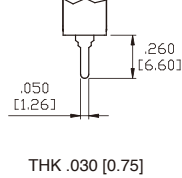

#### M3 Quick Connect

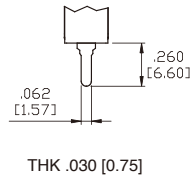

#### M5 Wire Wrap

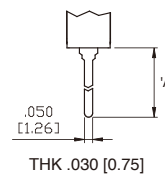

OPTION CODE	DIM. "A"
M5-1	.750 [19.05]
M5-2	.964 [24.48]
M5-3	.425 [10.80]
M5-4	1.062 [26.97]

## 2MS-Series Dimensional Specifications: in. [mm]

### Single Pole

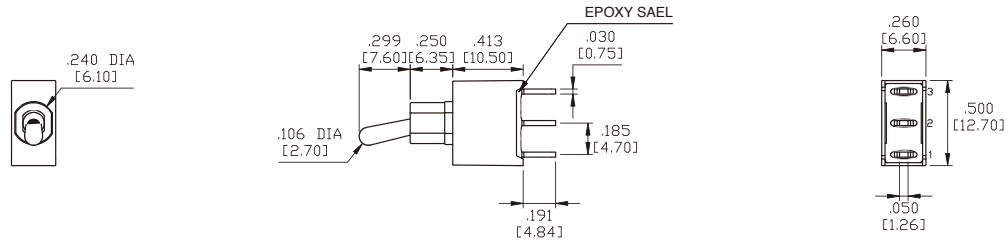

### Double Pole

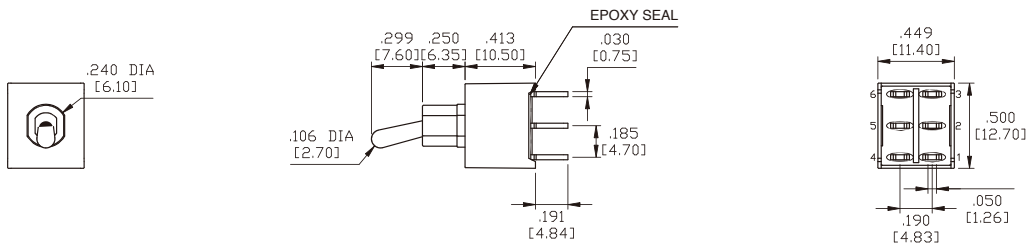

### Three Pole

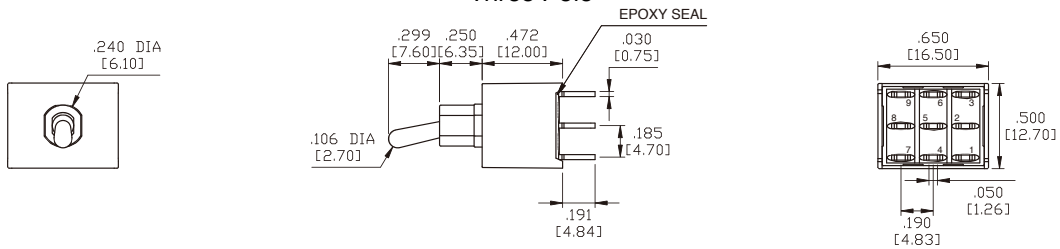

### Actuator Options

#### T1

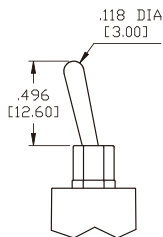

#### T2

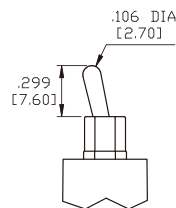

#### T9 with Plastic Cap

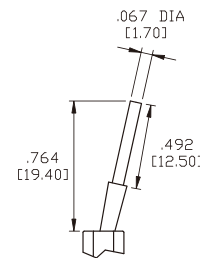

NO.	COLOR
1	White
2	Black(std.)
3	Red
4	Orange
5	Yellow
6	Green
7	Blue
8	Brown
9	Gray

#### P1 Plastic Toggle

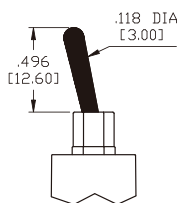

#### P2 Plastic Toggle

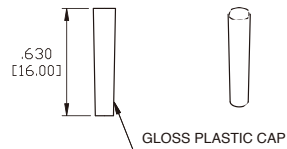
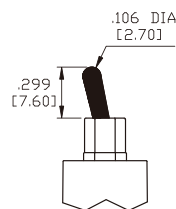

\* Shown with B4 bushing. Subtract .075" (1.90 mm) from actuator height for B1 bushing.

## 2MS-Series Dimensional Specifications: in. [mm]

### Bushing Options

**B1**

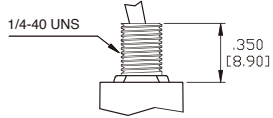

**B4**

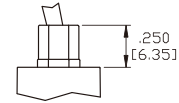

### Termination Options

**M1 Standard Solder Lug**

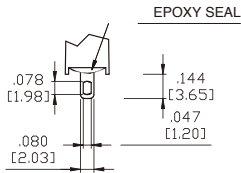

THK .030 [0.75]

**M2 PC Thru-Hole**

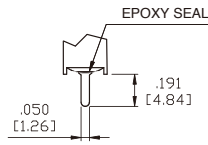

THK .030 [0.75]

**M3 Quick Connect**

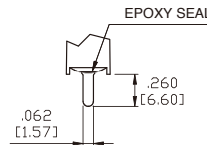

THK .030 [0.75]

**M5 Wire Wrap**

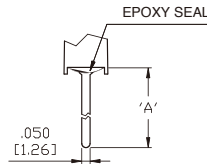

THK .030 [0.75]

OPTION CODE	DIM. 'A'
<b>M5-1</b>	.750 [19.05]
<b>M5-2</b>	.964 [24.48]
<b>M5-3</b>	.425 [10.80]
<b>M5-4</b>	1.062 [26.97]

**M6 Single Pole**

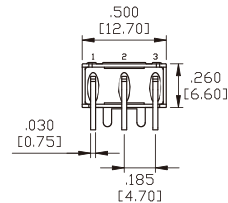
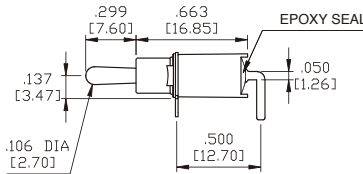
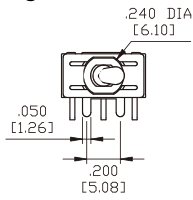

**P.C.MOUNTING**

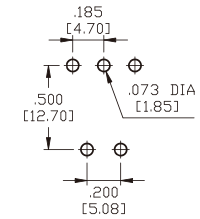

**M6 Double Pole**

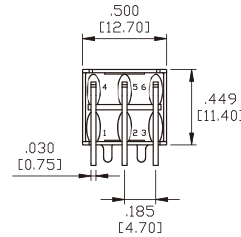
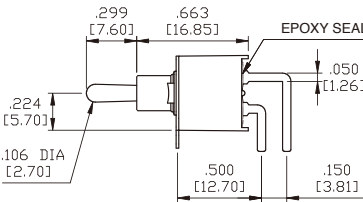
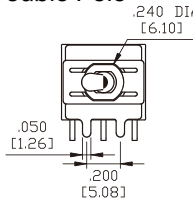

**P.C.MOUNTING**

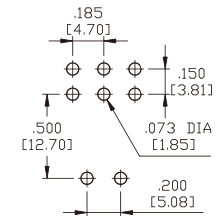

**M6 Three Pole**

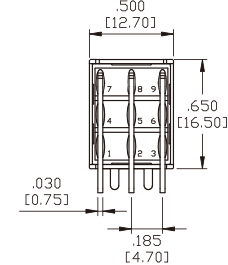
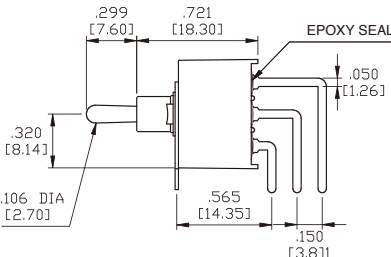
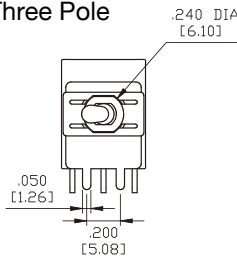

**P.C.MOUNTING**

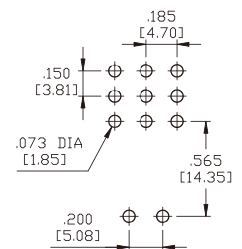

**M7 Single Pole**

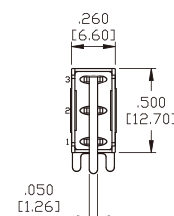
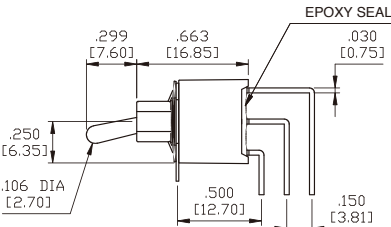
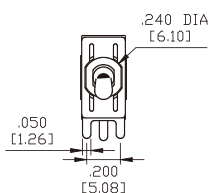

**P.C.MOUNTING**

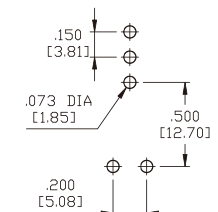

## 2MS-Series Dimensional Specifications: in. [mm]

### Termination Options

#### M7 Double Pole

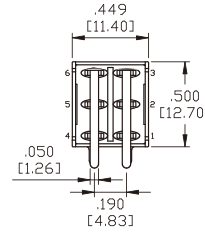
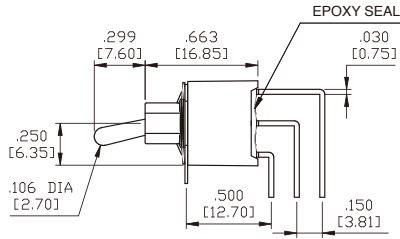
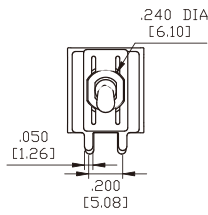

#### P.C.MOUNTING

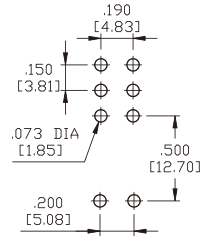

#### M7 Three Pole

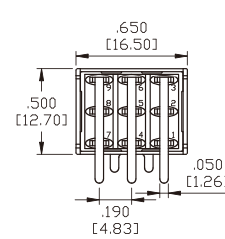
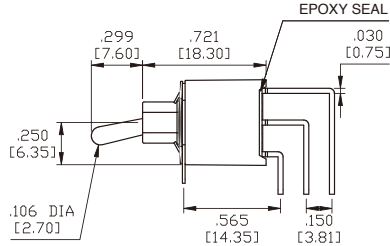
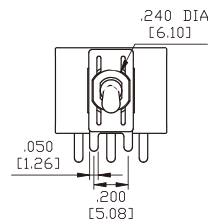

#### P.C.MOUNTING

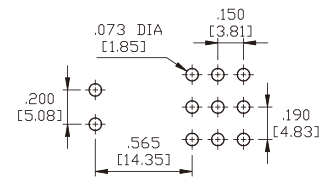

#### VS2-VS3 Single Pole

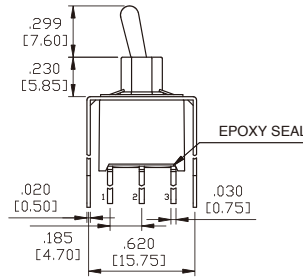
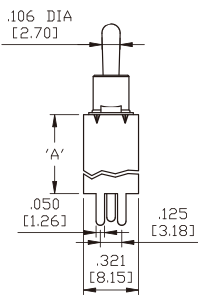

OPTION CODE	DIM.'A'
<b>VS2</b>	.461 [11.70]
<b>VS3</b>	.630 [16.00]

#### P.C.MOUNTING

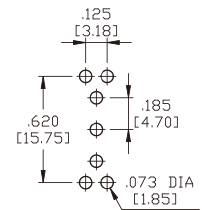

#### VS2-VS3 Double Pole

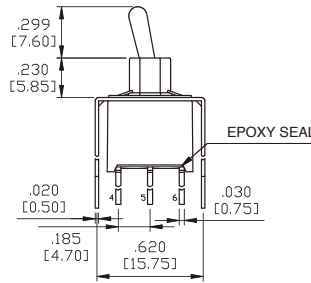
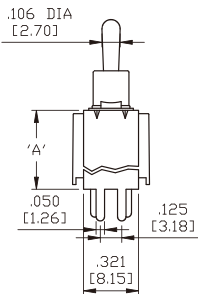

OPTION CODE	DIM.'A'
<b>VS2</b>	.461 [11.70]
<b>VS3</b>	.630 [16.00]

#### P.C.MOUNTING

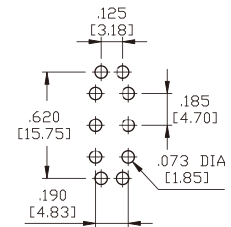

#### U2-VS3 Three Pole

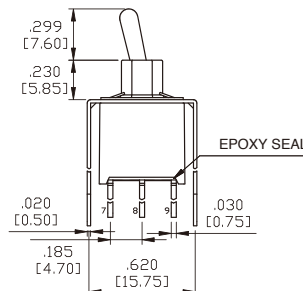
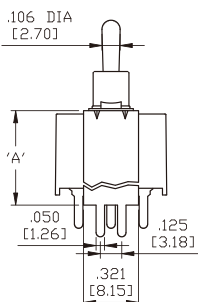

OPTION CODE	DIM.'A'
<b>U2</b>	.551 [14.00]
<b>VS3</b>	.630 [16.00]

#### P.C.MOUNTING

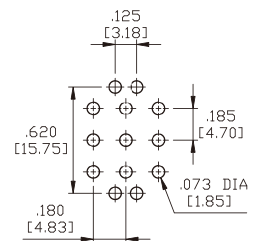



## 2MS-Series Dimensional Specifications: in. [mm]

### Termination Options

#### VS4-VS5 Single Pole

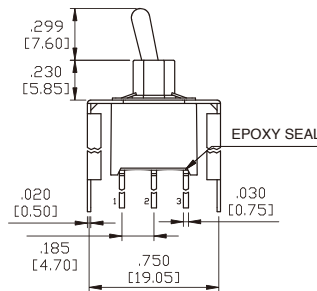
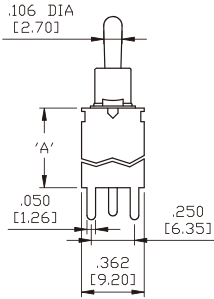

OPTION CODE	DIM.'A'
<b>VS4</b>	.461 [11.70]
<b>VS5</b>	.630 [16.00]

#### P.C.MOUNTING

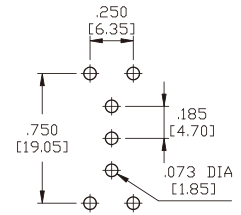

#### VS4-VS5 Double Pole

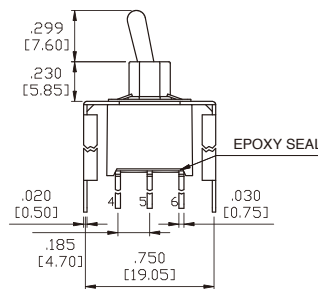
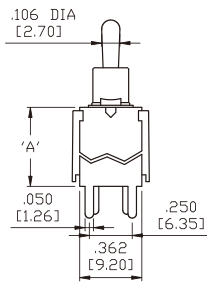

OPTION CODE	DIM.'A'
<b>VS4</b>	.461 [11.70]
<b>VS5</b>	.630 [16.00]

#### P.C.MOUNTING

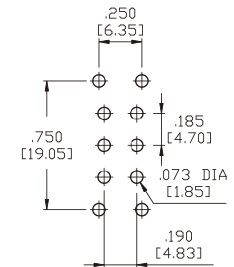

#### U4-VS5 Three Pole

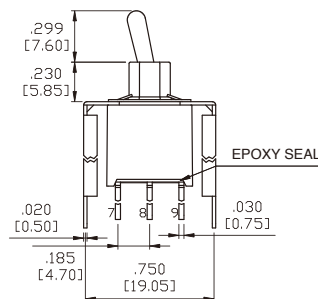
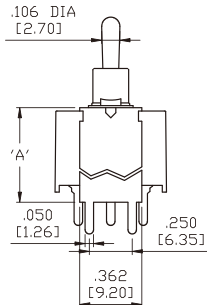

OPTION CODE	DIM.'A'
<b>U4</b>	.551 [14.00]
<b>VS5</b>	.630 [16.00]

#### P.C.MOUNTING

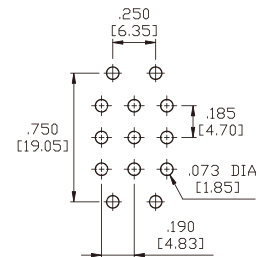

### Snap-In Termination Options

#### M61

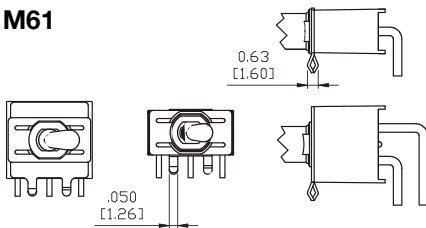

#### VS21, VS31

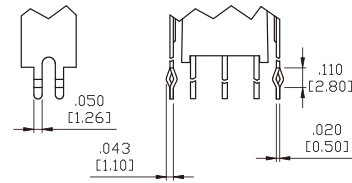

#### M71

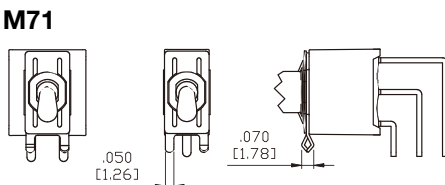

#### VS41, VS51

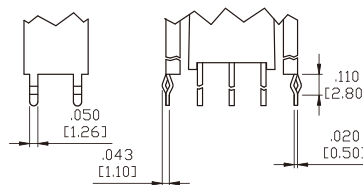

\* PC Mounting for M61, M71, VS21, VS31, VS41, VS51 refer to M6, M7, VS2, VS3, VS4, VS5 respectively.

## 2M1-Series Dimensional Specifications: in. [mm]

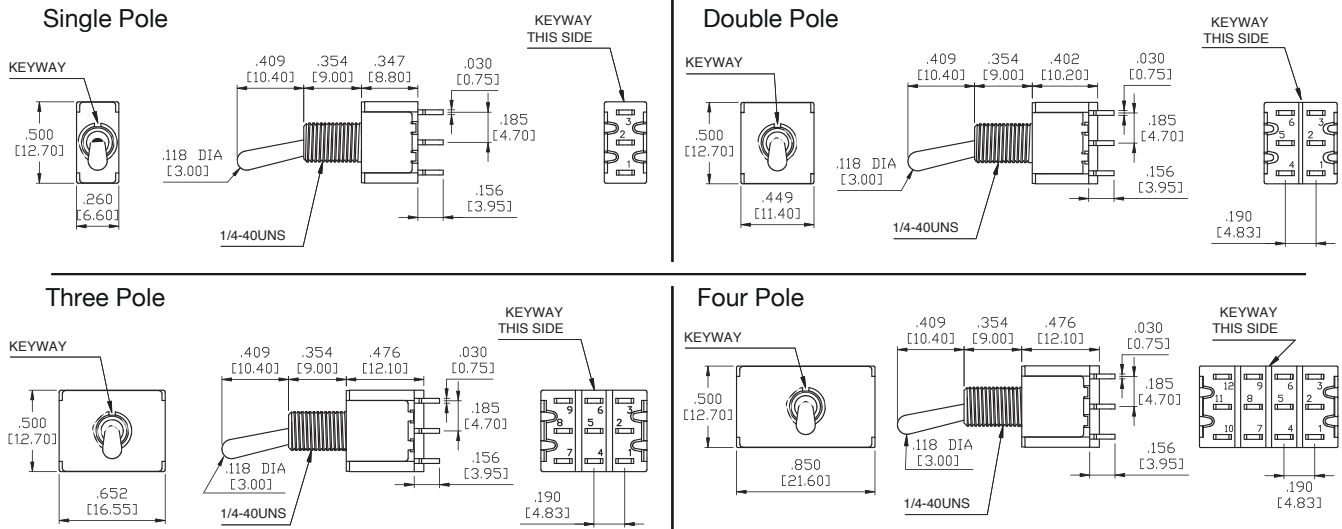

### Actuator Options for Panel Rear Mount

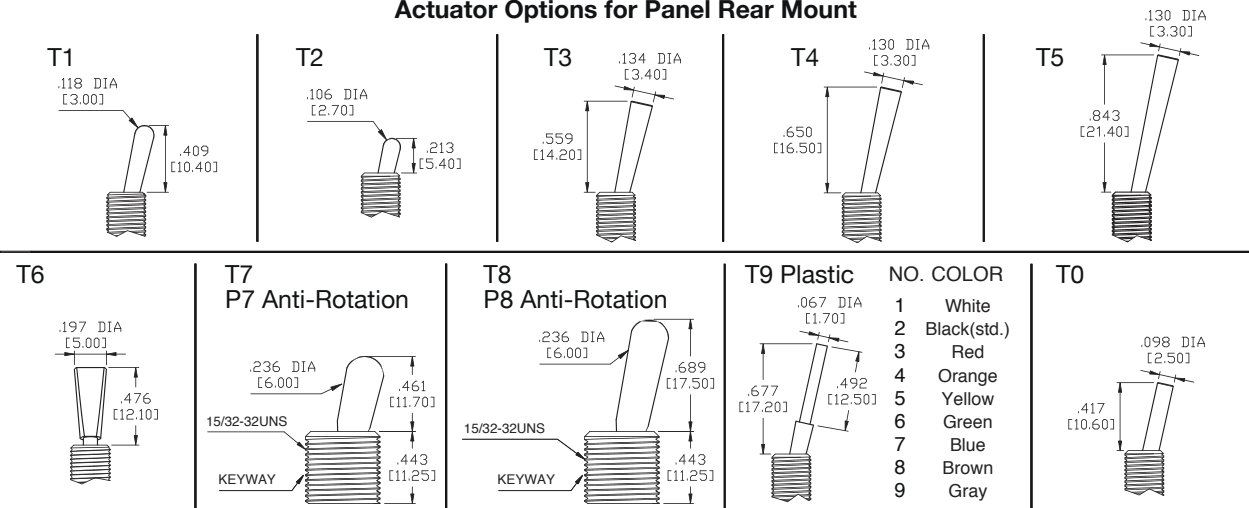

\* T6 actuator is available with B1, B2, B5, B6, BA, BB & BE bushing. Actuator length shown for T1 – T5, T9 and T10 is with B1 bushing. T7, P7, T8 & P8 does not require a bushing code.

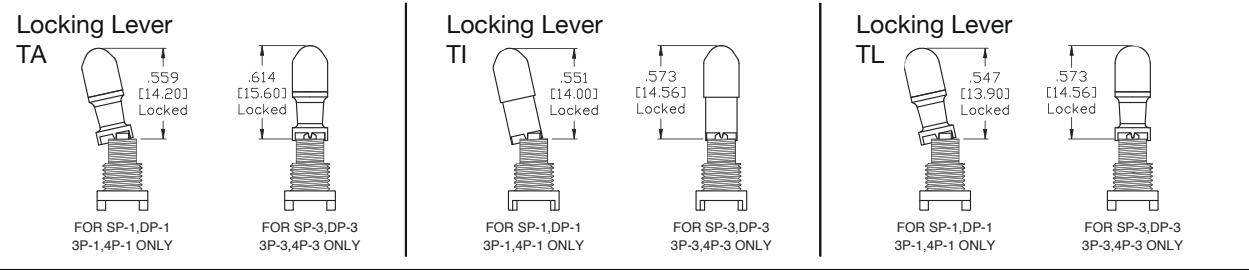

### Bushing Options

B1 Threaded  
B2 Non-Threaded

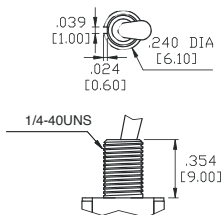

B3 Threaded  
B4 Non-Threaded

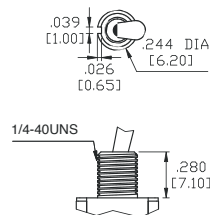

B5 High Torque

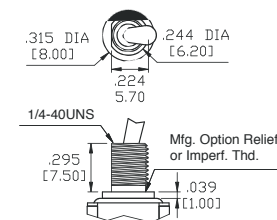

B6 High Torque

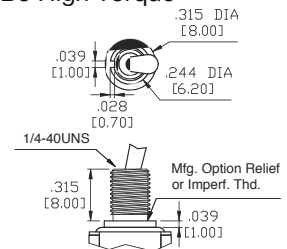

## 2M1-Series Dimensional Specifications: in. [mm]

### Bushing Options

B7 Long

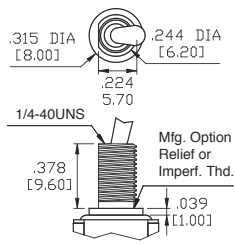

B8 Metric

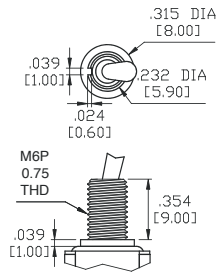

B9 Splash-Proof

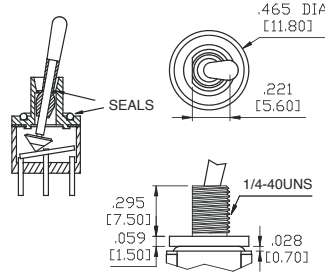

BL Locking Lever

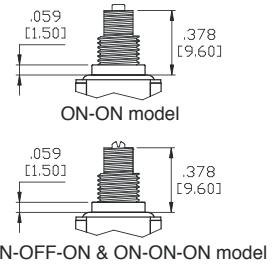

BA Threaded for T6

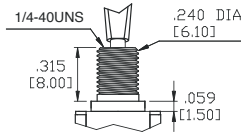

BB Non-Threaded for T6

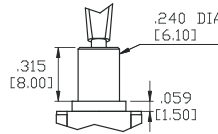

BB High Torque for T6

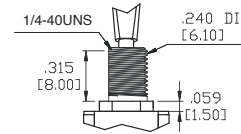

### Panel Mounting

1/4 INCH BUSHING

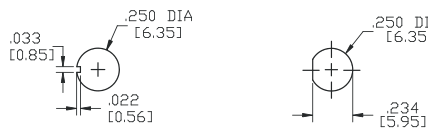

15/32 INCH BUSHING

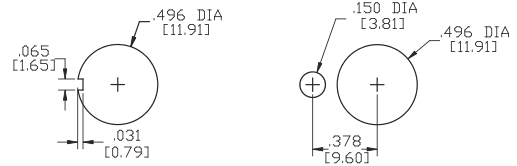

### Termination Options

M1 Standard Solder Lug

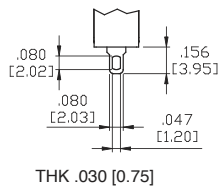

M2 PC Thru-Hole

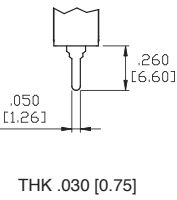

M3 Quick Connect

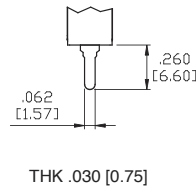

M5 Wire Wrap

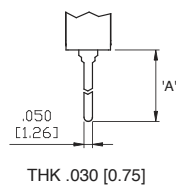

OPTION CODE	DIM.'A'
M5-1	.750 [19.05]
M5-2	.964 [24.48]
M5-3	.425 [10.80]
M5-4	1.062 [26.97]

M6 Single Pole

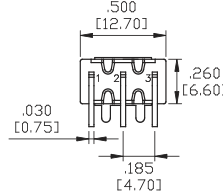
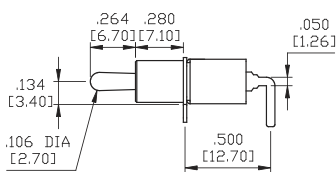
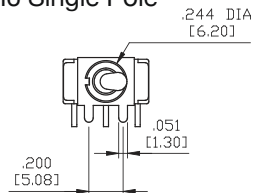

P.C. MOUNTING

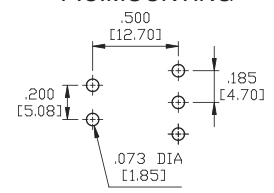

M6 Double Pole

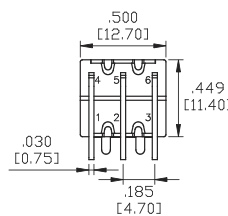
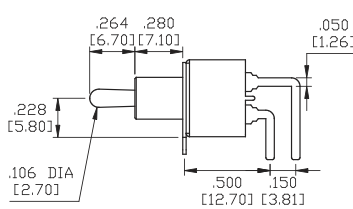
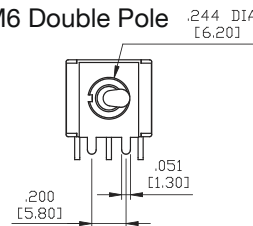

P.C. MOUNTING

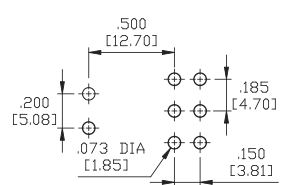

## 2M1-Series Dimensional Specifications: in. [mm]

### Termination Options

**M6 Three Pole** .244 DIA [6.20]

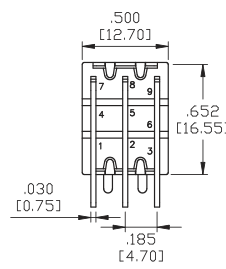
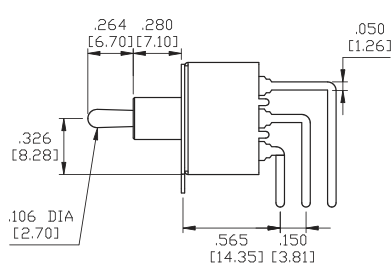
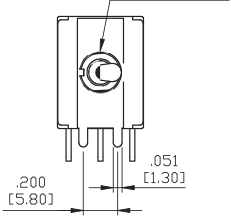

**P.C.MOUNTING**

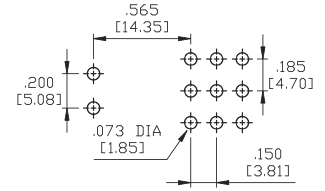

**M7 Single Pole** .244 DIA [6.20]

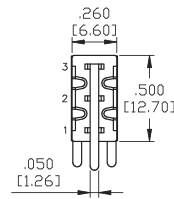
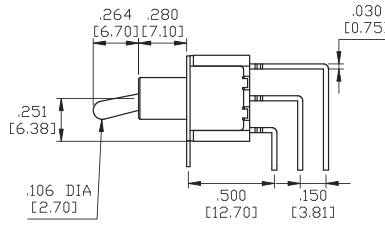
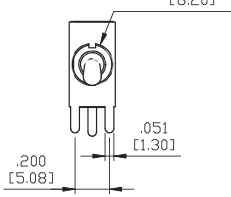

**P.C.MOUNTING**

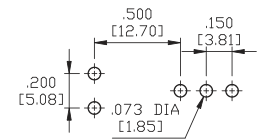

**M7 Double Pole** .244 DIA [6.20]

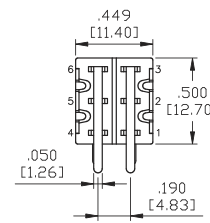
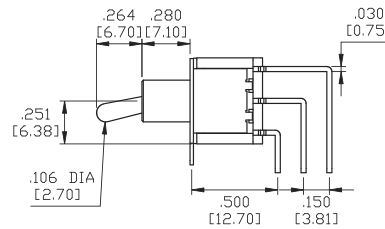
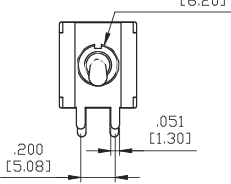

**P.C.MOUNTING**

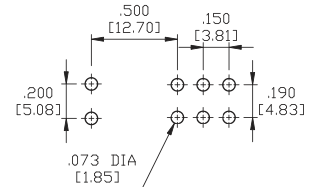

**M7 Three Pole** .244 DIA [6.20]

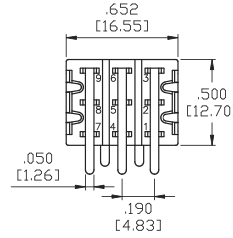
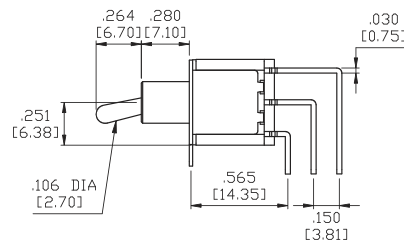
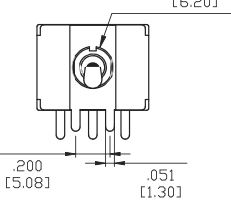

**P.C.MOUNTING**

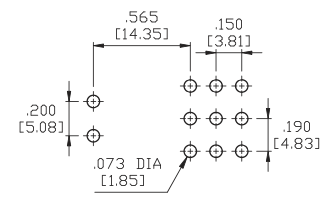

**M7 Four Pole** .244 DIA [6.20]

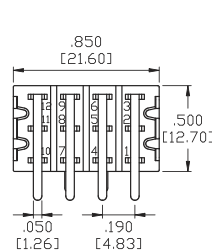
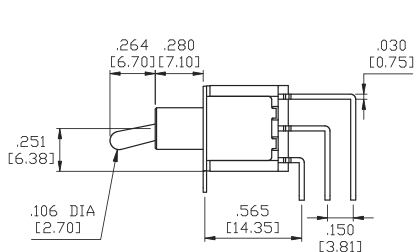
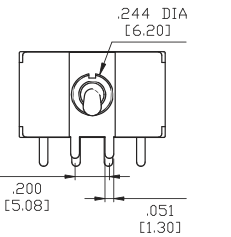

**P.C.MOUNTING**

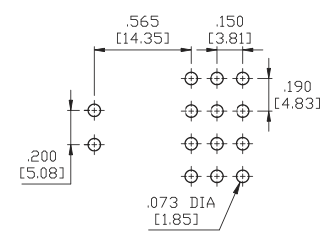

**VS2-VS3 Single Pole**

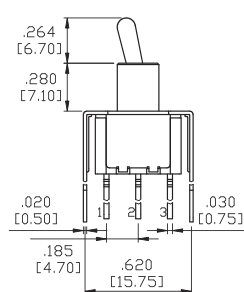
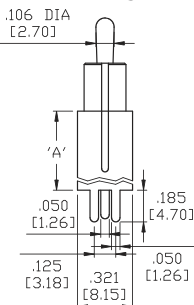

OPTION CODE	DIM. 'A'
VS2	.461 [11.70]
VS3	.630 [16.00]

**P.C.MOUNTING**

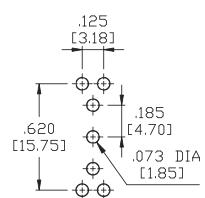

## 2M1-Series Dimensional Specifications: in. [mm]

### Termination Options

#### VS2-VS3 Double Pole

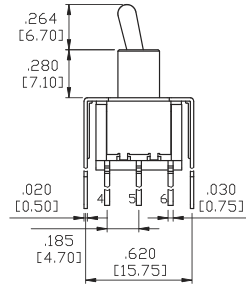
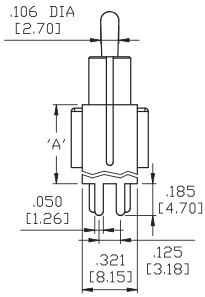

OPTION CODE	DIM. 'A'
VS2	.461 [11.70]
VS3	.630 [16.00]

#### P.C.MOUNTING

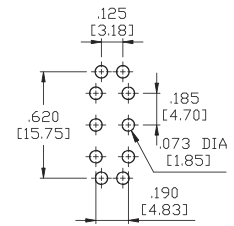

#### VS4-VS5 Single Pole

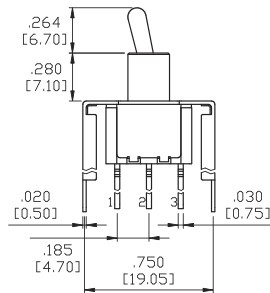
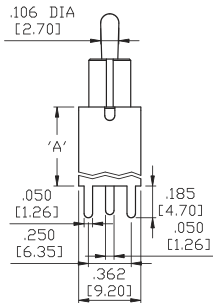

OPTION CODE	DIM. 'A'
VS4	.461 [11.70]
VS5	.630 [16.00]

#### P.C.MOUNTING

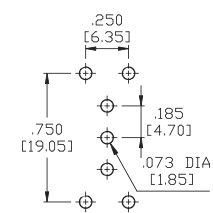

#### VS4-VS5 Double Pole

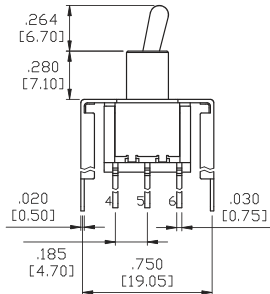
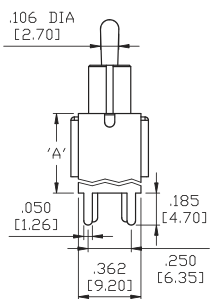

OPTION CODE	DIM. 'A'
VS4	.461 [11.70]
VS5	.630 [16.00]

#### P.C.MOUNTING

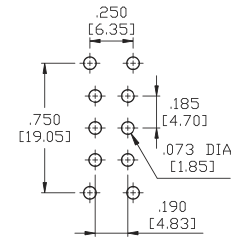

### Snap-In Termination Options

#### M61 (available with SP & DP)

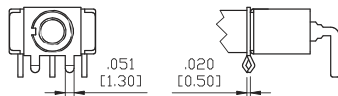

#### VS21, VS31

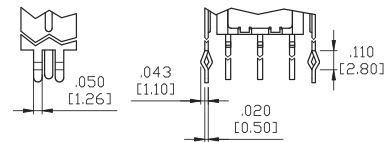

#### M71 (available with SP & DP)

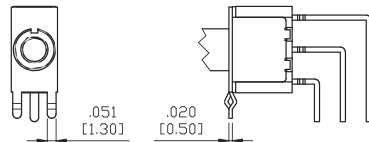

#### VS41, VS51

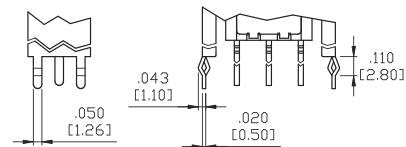

\* PC Mounting for M61, M71, VS21, VS31, VS41, VS51 refer to M6, M7, VS2, VS3, VS4, VS5 respectively.

## Authorized Sales Representatives and Distributors

Click on a region of the map below to find your local representatives and distributors or visit [www.carlingtech.com/findarep](http://www.carlingtech.com/findarep).



## About Carling

Founded in 1920, Carling Technologies is a leading manufacturer of electrical and electronic switches and assemblies, circuit breakers, electronic controls, power distribution units, and multiplexed power distribution systems. With four ISO registered manufacturing facilities and technical sales offices worldwide, Carling Technologies Sales, Service and Engineering teams do much more than manufacture electrical components, they engineer powerful solutions! To learn more about Carling please visit [www.carlingtech.com/company-profile](http://www.carlingtech.com/company-profile).

To view all of Carling's environmental, quality, health & safety certifications please visit [www.carlingtech.com/environmental-certifications](http://www.carlingtech.com/environmental-certifications)

## **Worldwide Headquarters**

Carling Technologies, Inc.  
60 Johnson Avenue, Plainville, CT 06062  
**Phone:** 860.793.9281 **Fax:** 860.793.9231  
**Email:** sales@carlingtech.com

**Northern Region Sales Office:** nrsm@carlingtech.com  
**Southeast Region Sales Office:** sersm@carlingtech.com  
**Midwest Region Sales Office:** mrrsm@carlingtech.com  
**West Region Sales Office:** wrsm@carlingtech.com  
**Latin America Sales Office:** larsm@carlingtech.com

## **Asia-Pacific Headquarters**

Carling Technologies, Asia-Pacific Ltd.,  
Suite 1607, 16/F Tower 2, The Gateway,  
Harbour City, 25 Canton Road,  
Tsimshatsui, Kowloon, Hong Kong  
**Phone:** Int + 852-2737-2277 **Fax:** Int + 852-2736-9332  
**Email:** sales@carlingtech.com.hk

**Shenzhen, China:** shenzhen@carlingtech.com  
**Shanghai, China:** shanghai@carlingtech.com  
**Pune, India:** india@carlingtech.com  
**Kaohsiung, Taiwan:** taiwan@carlingtech.com  
**Yokohama, Japan:** japan@carlingtech.com

## **Europe | Middle East | Africa Headquarters**

Carling Technologies LTD  
4 Airport Business Park, Exeter Airport,  
Clyst Honiton, Exeter, Devon, EX5 2UL, UK  
**Phone:** Int + 44 1392.364422 **Fax:** Int + 44 1392.364477  
**Email:** ltd.sales@carlingtech.com

**Germany:** gmbh@carlingtech.com  
**France:** sas@carlingtech.com



**Carling Technologies®**

Innovative Designs. Powerful Solutions.

## X-ON Electronics

Largest Supplier of Electrical and Electronic Components

*Click to view similar products for [Rocker Switches](#) category:*

*Click to view products by [Carling](#) manufacturer:*

Other Similar products are found below :

[VKD2GHNB-00000-000](#) [VSD2GNNB-00000-000](#) [6-1571986-5](#) [6-1571986-9](#) [632422-4B-KD](#) [7036WWCDBX653+U622](#) [8055K52Z7V](#)  
[8138K20E6M50](#) [FMC18A2200002](#) [84206L](#) [84312LX](#) [PREDD4-07F-BB0FW](#) [PREDD5-07F-BB0GW](#) [PRFDD1-16F-BB000](#) [PRFDD3-16F-](#)  
[BB000](#) [1-1634201-0](#) [999-16702-001](#) [A101J2ZQ004](#) [A101J4ZQ004](#) [A101J51CB0004](#) [A107J51ZQ0004](#) [A201J1AQ004](#) [A201J1AV2Q004](#)  
[A201J3ZB004](#) [A201J50ZQ004](#) [A203J51ZQ0004](#) [A226L11YZQ](#) [A22L11A](#) [A435S1YZQ](#) [H8500XBBBBL-A](#) [H8653VBBG2577W](#)  
[HB130CHNWWNAAC](#) [1251.0303](#) [AE205J60V3B004](#) [RH110C2NBB](#) [1352.0107](#) [1363.0201](#) [AML25GBF2AA03GR](#) [1571099-3](#) [1571987-4](#)  
[1571987-5](#) [1571989-7](#) [B123J77V7B2](#) [B226J50W4Q22P](#) [B433J37ZQ22M](#) [160212E](#) [1801.1164](#) [1831.1102](#) [1833.3402](#) [1837.1118](#)