

2S-Series

Miniature Toggles Switches

[PRODUCT WEBPAGE](#)

request sample, configure part

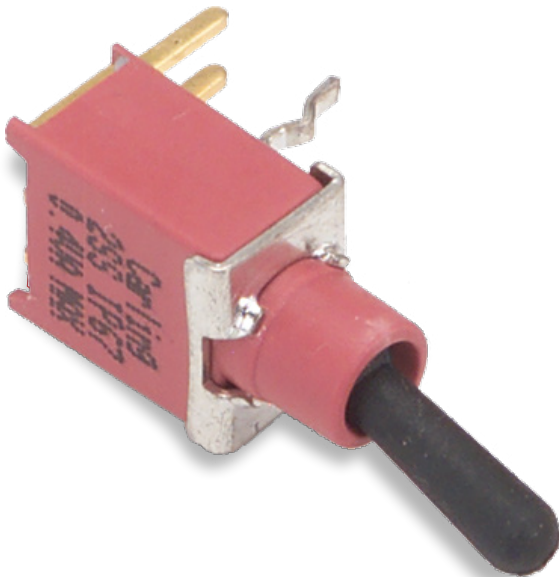
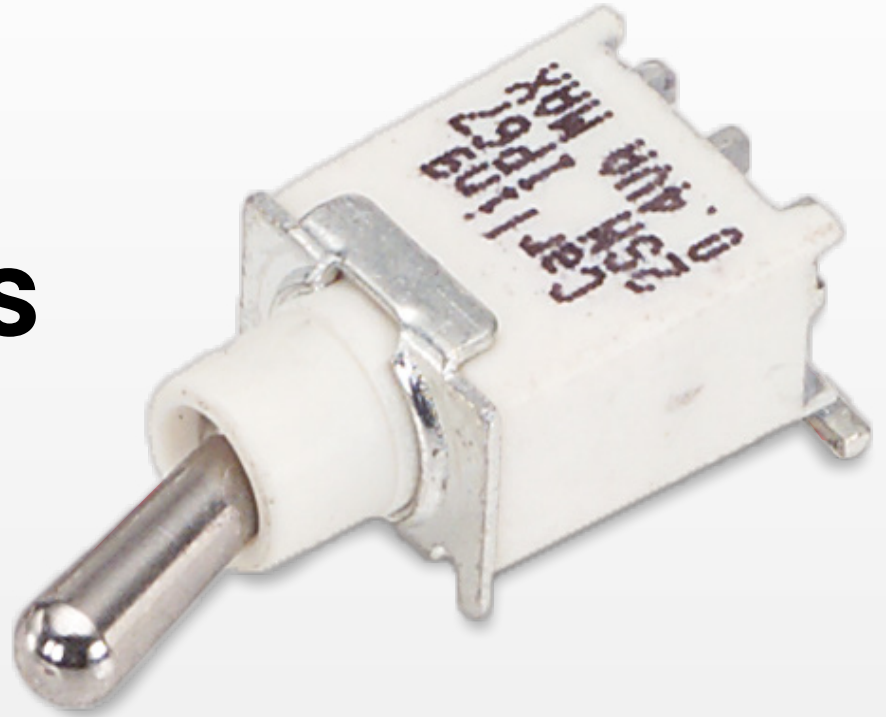

The 2S family of sub-miniature toggle switches is composed of three switch series; the 2S1-Series toggle switch, the 2SS-Series sealed toggle switch, and the 2SM-Series surface mount sealed sub-miniature toggle switch. All of these series offer a variety of ratings, circuits, contact materials, terminal platings, and actuator types.

1-2 Poles **.4-3** Amps **125, 250** VAC **28** VDC

Typical Applications

- Instrumentation
- Telecommunications
- Networking
- Medical
- Military

Tech Specs

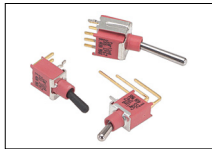

2SS-Series
Sealed
Sub-Miniature
Toggle Switch



2SI-Series
Sub-Miniature
Toggle Switch

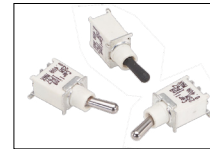

2SM-Series
Sealed Surface Mount
Sub-Miniature
Toggle Switch

Electrical

Contact Rating	refer to ordering scheme
Electrical Life	30,000 make & break cycles @ full load
Contact Resistance	20 mΩ max. initial @ 2-4 VDC 100mA for both silver & gold plated contacts
Insulation Resistance	1000 MΩ min.
Dielectric Strength	1500 Volts RMS @ sea level

Physical

Operating Temperature	-30°C to +85°C
Index of Protection	2SS & 2SM-Series: IP67
Solder Heat Resistance	MIL-STD-202, Method 210
Actuator Travel	25°

Material

Case	all UL94 V-0 2SI-Series: Dially phthalate (DAP) 2SS-Series: Glass filled nylon 6/6, flame retardant, heat stabilized 2SM-Series: Glass filled nylon 4/6, flame retardant, heat stabilized
Rocker	2SI-Series: Brass, chrome plated. 2SS & 2SM-Series: Brass, chrome plated or nylon, internal o-ring seal
Bushing	2SI-Series: Brass, nickel plated 2SS-Series: Glass filled nylon 6/6, flame retardant, heat stabilized (UL 94V-0) 2SM-Series: Glass filled nylon 4/6, flame retardant, heat stabilized (UL 94V-0)
Housing	Stainless Steel
Switch Support	Brass, tin plated
Terminal Seal	Epoxy

Ordering Scheme

Sample Part Number 2SS - MSP 1 - T1 - B4 - M6 G E

Selection 1 2 3 4 5 6 7 8

1. SERIES

2SS Sealed Sub-Miniature Toggle Switch

2. POLES

MSP Single pole - uses terminals 1, 2 & 3
MDP Double pole - uses terminals 1, 2, 3, 4, 5 & 6

3. CIRCUIT

() - momentary
Position: **1** **2** **3**

1	2-3, 5-6	Connected Terminals	2-1, 5-4
2	ON	NONE	ON
3	ON	NONE	(ON)
4	(ON)	OFF	ON
5	ON	OFF	(ON)

4. ACTUATOR STYLE / LENGTH

T1	Round toggle .421" [10.70 mm]	P2	ESD resistant toggle .268" [6.80 mm]
T2	Round toggle .240" [6.10 mm]	P3	ESD resistant toggle .244" [6.20 mm]
T3	Round toggle .342" [8.70 mm]	P4	ESD resistant toggle .291" [7.40 mm]
T4	Round toggle .551" [14.00 mm]		
P1	ESD resistant toggle .425" [10.80 mm]		

5. BUSHING

B1 Threaded **B4** Unthreaded

6. TERMINATION

M1 Solder Lug	M7 PC Mount, 90° vertical
M2 PCB	M71 Snap-In, U bracket, 90° horizontal
M6 PC Mount, 90° horizontal	VS2 PC Mount, U bracket
M61 Snap-In, U bracket, 90° horizontal	VS21 Snap-In, U bracket

7. CONTACTS / TERMINALS

Contact	Material	Terminal Plating	Rating	Approvals
G	silver ¹	gold over silver	3A 125VAC or 28VDC, 1.5A 250VAC	IP67
K	gold ²	tin ³	0.4VA max 20V max (AC/DC)	IP67
P	silver ¹	tin ³	3A 125VAC o28VDC, 1.5A 250VAC	IP67
R	gold ²	gold ²	0.4VA max 20V max (AC/DC)	IP67

8. EPOXY SEAL

E Epoxy Seal **0** without Epoxy Seal

Notes:

- Tin option not available with M1 terminal.
- ¹ Movable contact & terminal platings: silver over copper alloy
- ² Movable contact & terminal platings: gold over nickel over copper alloy
- ³ Terminal platings: tin over nickel over copper alloy

[Configure Complete Part Number >](#)

[Browse Standard Parts >](#)

Ordering Schemes

Sample Part Number 2S1 - MSP 1 - T1 - B4 - M6 Q E

Selection 1 2 3 4 5 6 7 8

1. SERIES

2S1 Sub-Miniature Toggle Switch

2. POLES

MSP Single pole - uses terminals 1, 2 & 3
MDP Double pole - uses terminals 1, 2, 3, 4, 5 & 6

3. CIRCUIT

() - momentary
Position: **1** **2** **3**
1 2-3, 5-6 ON ON ON
2 ON NONE NONE (ON)
3 ON OFF OFF ON
4 (ON) OFF OFF (ON)
5 ON OFF OFF (ON)

4. ACTUATOR STYLE

T1 Round toggle .374" [9.50 mm] **T4** Round toggle .449" [11.40 mm]
T3 Round toggle .311" [7.90 mm]
T2 Round toggle .236" [6.00 mm]

5. BUSHING

B1 Threaded Standard, keyway **B5** High Torque, flat, .276"
B2 Non-Threaded Standard, keyway **B6** High Torque, keyway, .276"
B3 Threaded Short, keyway **B7** Long threaded
B4 Non-Threaded Short, keyway **B8** Non threaded Long, keyway

[Configure Complete Part Number >](#) [Browse Standard Parts >](#)

6. TERMINATION

M1 Solder Lug **M6** PC Mount, 90° horizontal
M71 Right Angle PC Thru Hole, vertical **VS21** Snap-In, U bracket
M2 PCB **M61** Snap-In, Right Angle
VS2 PC Mount, U bracket **M7** PC Mount, 90° vertical

7. CONTACTS / TERMINALS

Contact Material	Terminal Plating	Rating	Approvals
G silver ²	gold over silver	3A 125VAC or 28VDC, 1.5A 250VAC	UL, CE
K ⁸ gold ^{3,6}	tin ⁵	0.4VA max 20V max (AC/DC)	N/A
P ⁸ silver ^{2,7}	tin ⁵	3A 125VAC or 28VDC,	UL, CE
Q silver ²	1.5A 250VAC silver ²	3A 125VAC or 28VDC	UL, CE
R gold ³	1.5A 250VAC gold ⁴	0.4VA max 20V max (AC/DC)	N/A

8. EPOXY SEAL

E Epoxy Seal **0** without Epoxy Seal

Notes: Tin option available with PC type terminations only.

- All Switches come with standard nut, washer and locking ring shipped bulk. B5 & B7 ushing styles use small locking ring. See page 76-77
- Movable contact and terminal platings: silver over copper alloy
- Movable contact and terminal platings: gold over nickel over copper alloy
- Terminal platings: gold over nickel over copper alloy
- Terminal platings: tin over copper alloy
- Terminal contact platings: gold over nickel alloy
- Terminal contact platings: silver over nickel alloy
- Not available with M1 terminal
- Lengths shown are with B1 - B4 bushings.
For B5 & B6 subtract .108", for B7 & B8 subtract .043"

Sample Part Number 2SM - MSP 1 - T1 - M6 G E T/R

Selection 1 2 3 4 5 6 7 8

1. SERIES

2M1 Miniature Toggle Switch

2. POLES

MSP Single pole - uses terminals 1, 2 & 3

3. CIRCUIT

() - momentary
Position: **1** **2** **3**
1 2-3 ON ON ON
2 ON NONE NONE (ON)
3 ON OFF OFF ON
4 (ON) OFF OFF (ON)
5 ON OFF OFF (ON)

4. ACTUATOR STYLE / LENGTH

T1 Round toggle .425" [10.80 mm] .244" [6.20 mm]
T2 Round toggle .240" [6.10 mm] **P4** ESD resistant plastic toggle .291" [7.40 mm]
P1 ESD resistant plastic toggle .425" [10.80 mm]
P2 ESD resistant plastic toggle .268" [6.80 mm]
P3 ESD resistant plastic toggle

5. TERMINATION

K6 Surface Mount, .433" [11.00 mm] **M7** Surface Mount, 90° vertical
L6 Surface Mount, .354" [9.00 mm] **S6** Surface Mount, 90°, .353" [8.96 mm]
M6 Surface Mount, 90° flat, .2X86" [7.26 mm] See dimensional specifications.

6. CONTACTS / TERMINALS

Contact Material	Terminal Plating	Rating	Approvals
G silver ²	gold over silver	3A 125VAC or 28VDC, 1.5A 250VAC	IP67
K gold ³	tin ⁴	0.4VA max 20V max (AC/DC)	IP67
P silver ²	tin ⁴	3A 125VAC or 28VDC, 250VAC	IP67
Q silver ²	1.5A silver ²	3A 125VAC or 28VDC, 250VAC	IP67
R gold ³	1.5A gold ³	0.4VA max 20V max (AC/DC)	IP67

7. EPOXY SEAL

E Epoxy Seal **0** without Epoxy Seal

8. PACKAGING

T/R tape reel - 500 pieces per reel
Switches are bulk packed, unless T/R is specified at the end of the part number.

Notes:

- Tin option available with PC type terminations only.
- Bushing is unthreaded .177" [4.50 mm] height
 - Movable contact & terminal platings: silver over copper alloy
 - Movable contact & terminal platings: gold over nickel over copper alloy
 - Terminal platings: tin over nickel over copper alloy

[Configure Complete Part Number >](#) [Browse Standard Parts >](#)

Dimensional Specs

inches [millimeters]

Single Pole

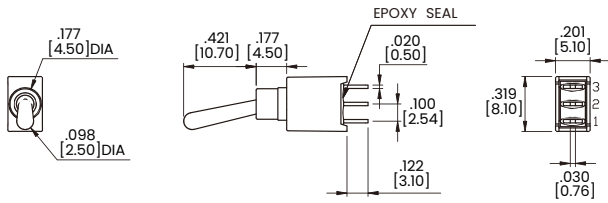

Double Pole

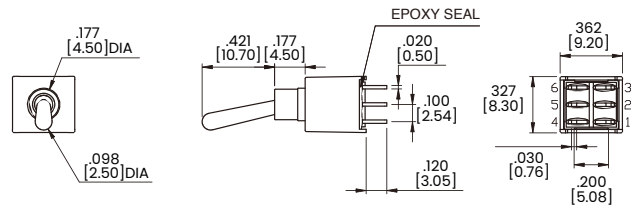

Actuator Options

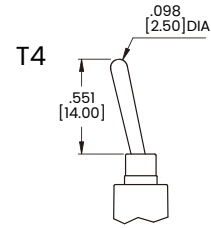
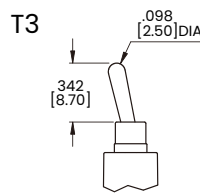
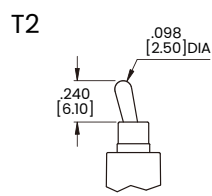
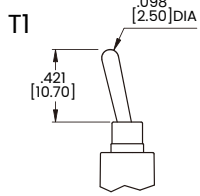

* B4 bushing shown. Subtract 2.55mm from toggle length for B1 bushing.

P1 Plastic Toggle

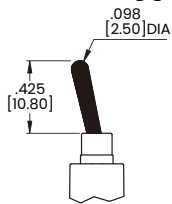

P2 Plastic Toggle

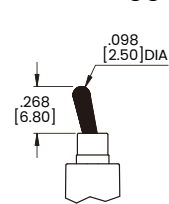

P3 Plastic Toggle

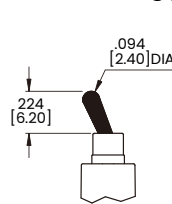

P4 Plastic Toggle

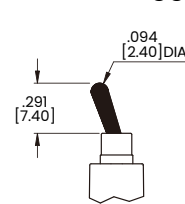

Bushing Options

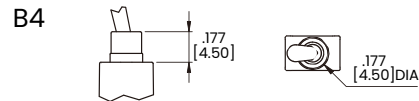
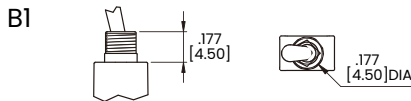

* Subtract 2.55mm from toggle length for B1 bushing.

Termination Options

M1 STD. Solder Lug

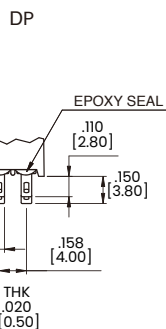
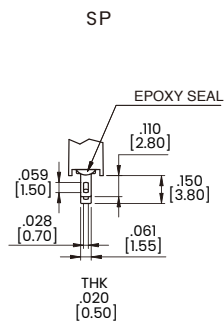

M2 PC Thru-Hole

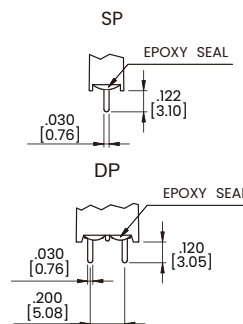

P.C.MOUNTING

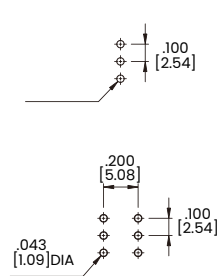

M6 Single Pole

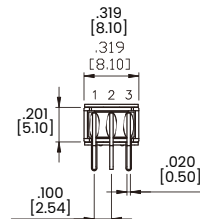
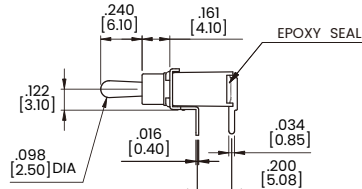
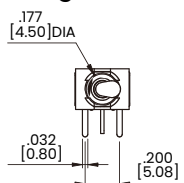

P.C.MOUNTING

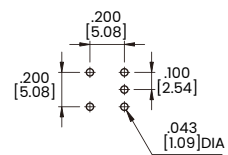

Dimensional Specs

inches [millimeters]

M6 Double Pole

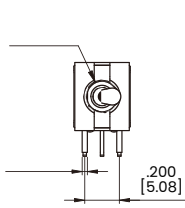

Termination Options

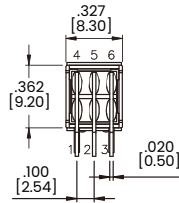
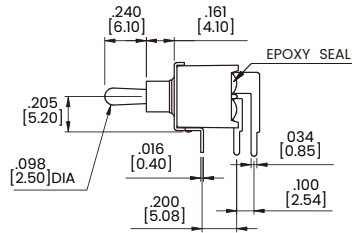

P.C.MOUNTING

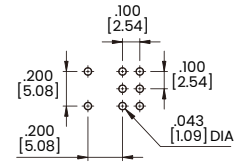

M7 Single Pole

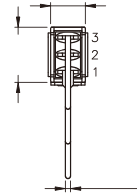
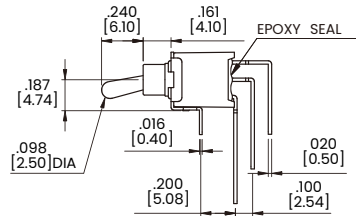
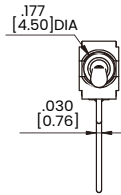

P.C.MOUNTING

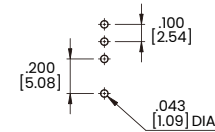

M7 Double Pole

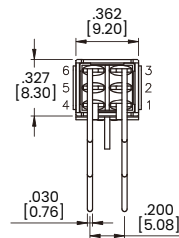
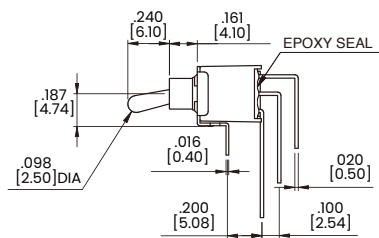
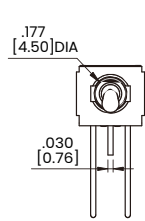

P.C.MOUNTING

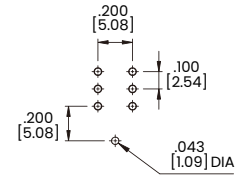

VS2 Single Pole

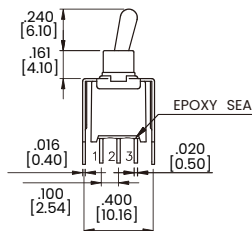
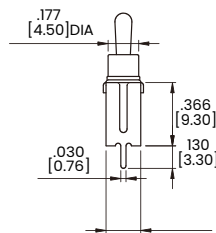

P.C.MOUNTING

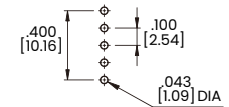

VS2 Double Pole

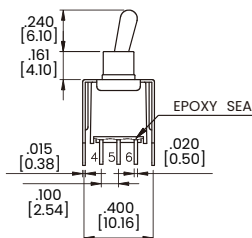
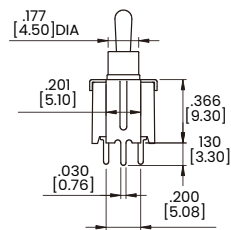

P.C.MOUNTING

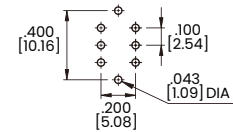

Snap-In Termination Options

M61

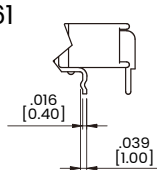

M71

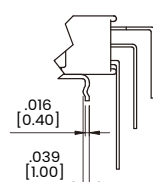

VS21

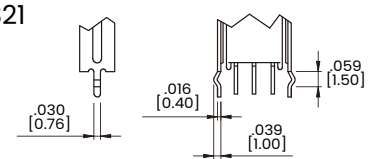

* PC Mounting for M61,M71,VS21 refer to M6,M7,VS2 respectively.

Dimensional Specs

inches [millimeters]

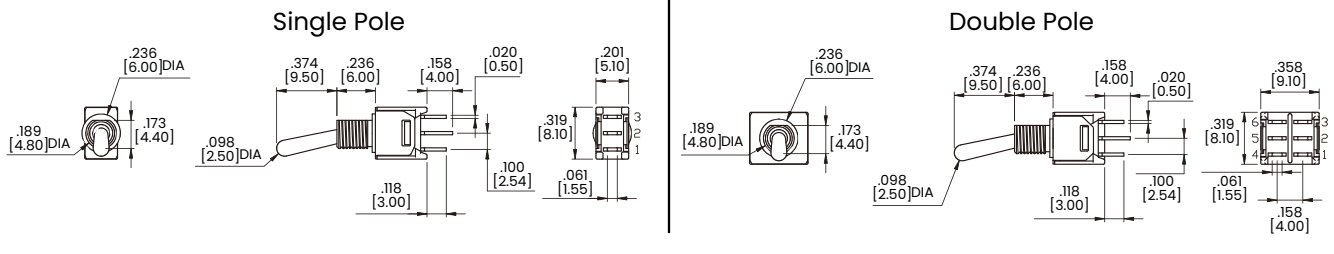

Actuator Options

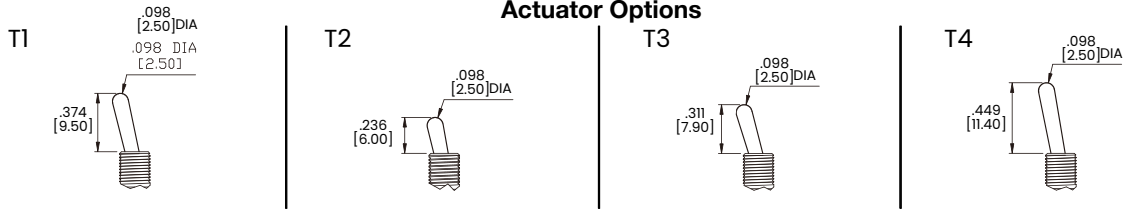

Bushing Options

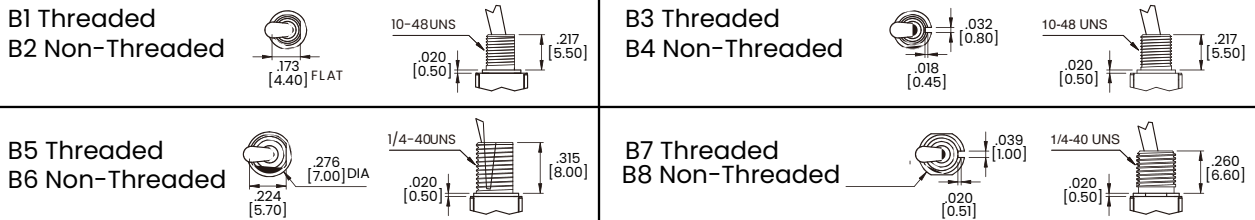

Panel Mounting

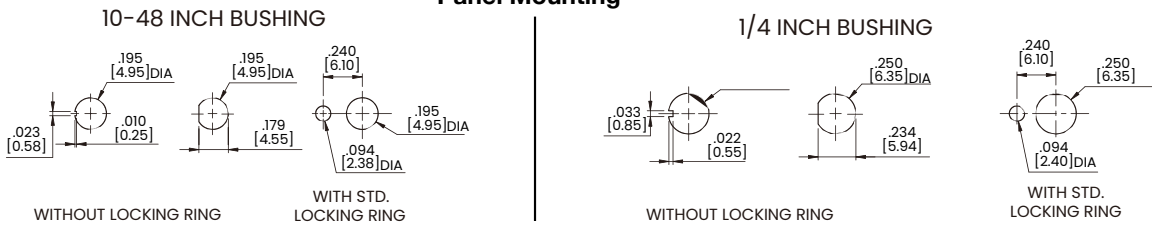

Termination Options

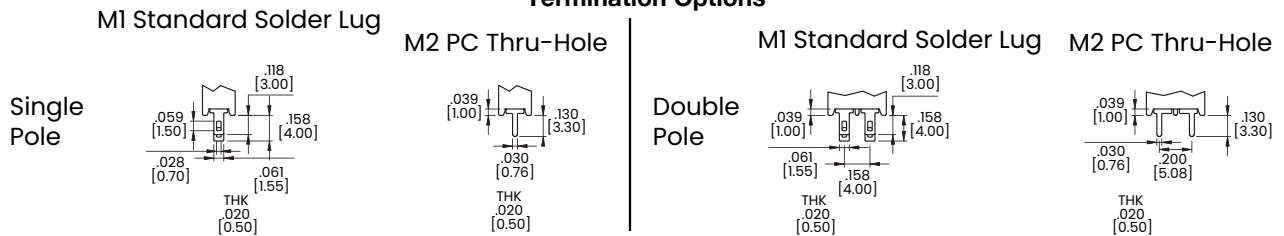

M6 Single Pole

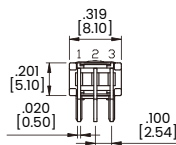
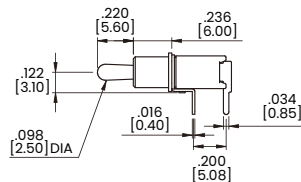
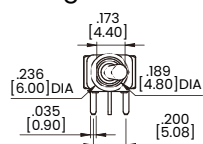

P.C. MOUNTING

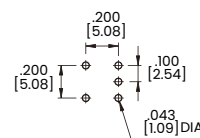

Dimensional Specs

inches [millimeters]

Termination Options

M6 Double Pole

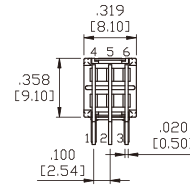
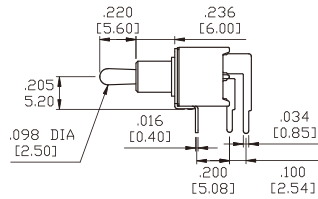
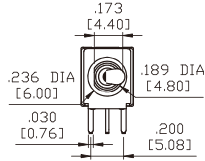

P.C.MOUNTING

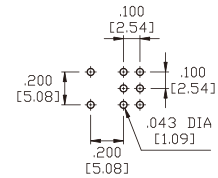

M7 Single Pole

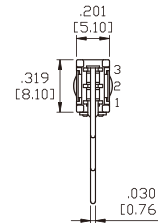
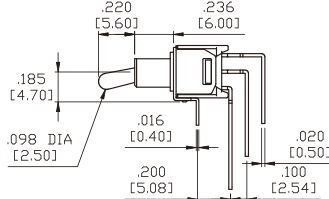
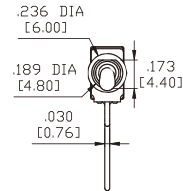

P.C.MOUNTING

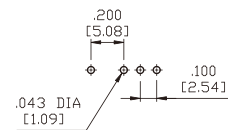

M7 Double Pole

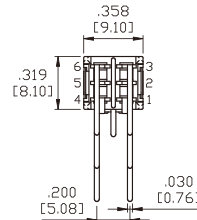
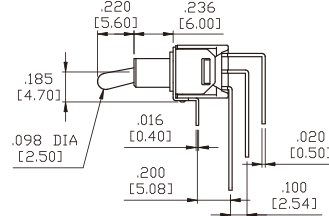
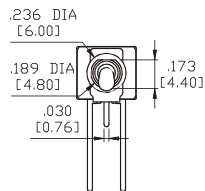

P.C.MOUNTING

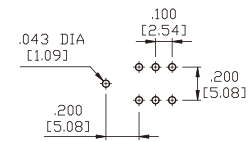

VS2-VS3 Single Pole

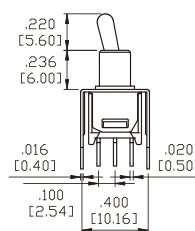
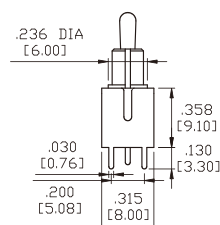
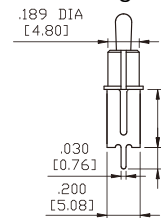

P.C.MOUNTING

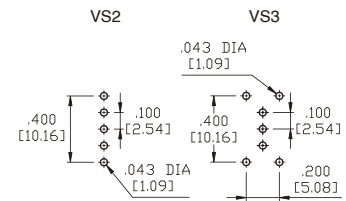

VS2-VS3 Double Pole

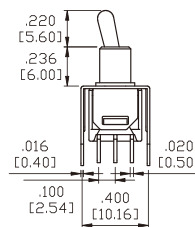
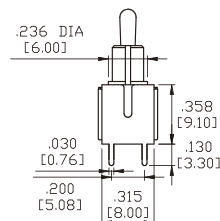
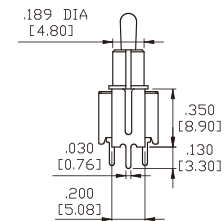

P.C.MOUNTING

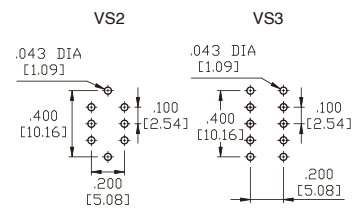

Snap-In Termination Options

M61

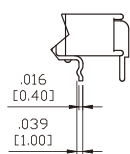

M71

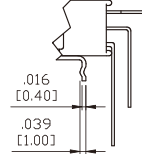

VS21

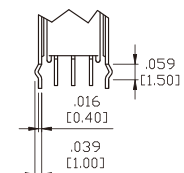
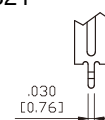

* PC Mounting for M61, M71, VS21 refer to M6, M7, VS2 respectively.

Dimensional Specs

inches [millimeters]

K6 Single Pole

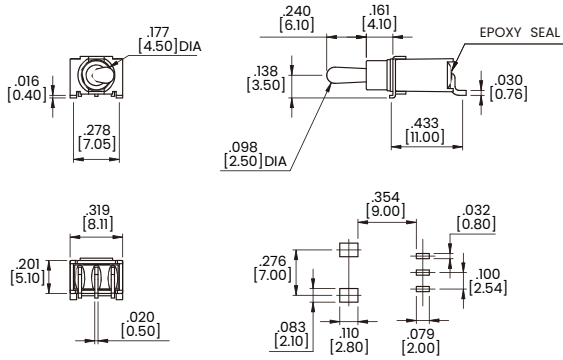

L6 Single Pole

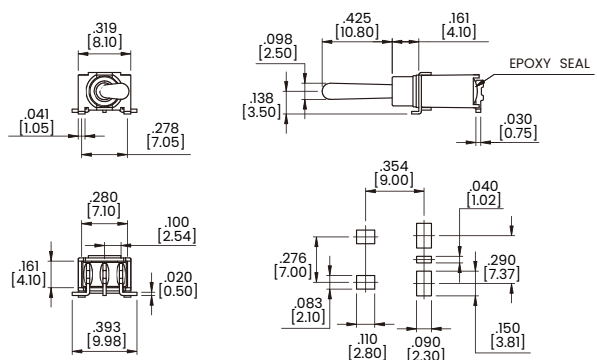

M6 Single Pole

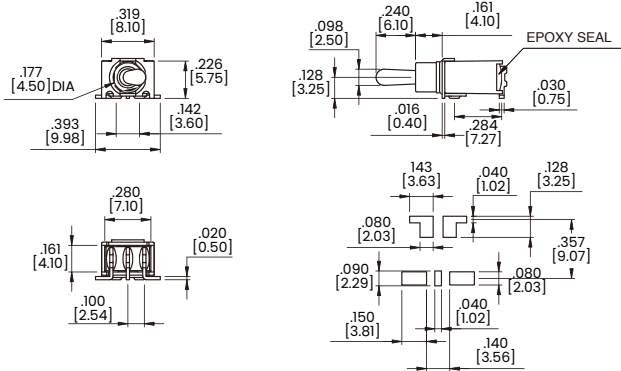

M7 Single Pole

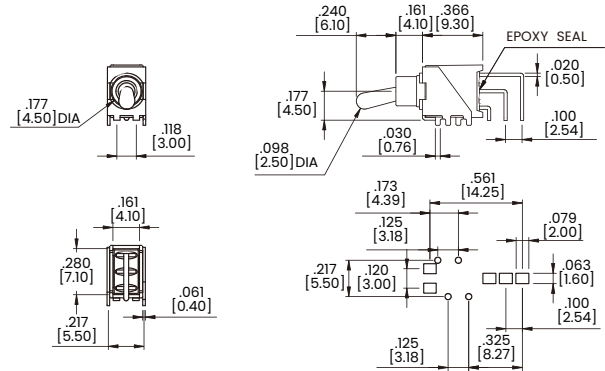

S6 Single Pole

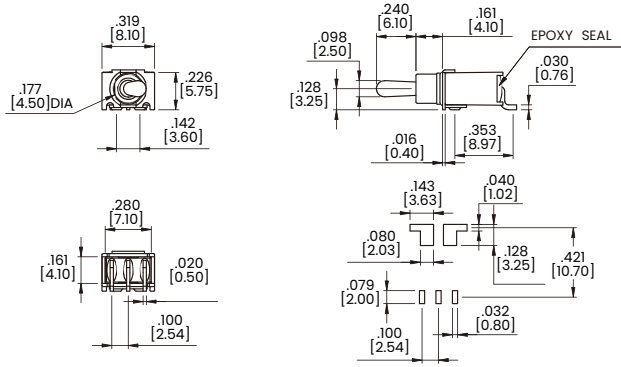

Actuator Options

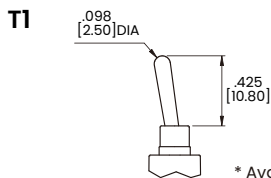

* Available with L6, S6, K6, M7 terminals only.

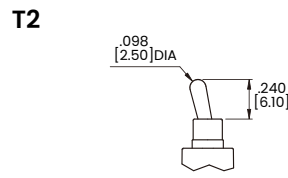

P1 Plastic Toggle

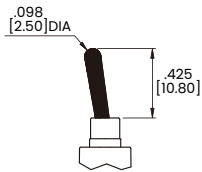

P2 Plastic Toggle

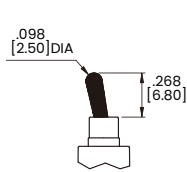

P3 Plastic Toggle

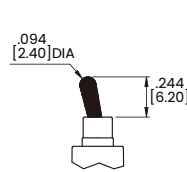

P4 Plastic Toggle

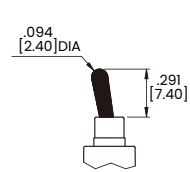

Authorized Sales Representatives and Distributors

Click on a region of the map below to find your local representatives and distributors or visit www.carlingtech.com/findarep.



About Carling

Founded in 1920, Carling Technologies is a leading manufacturer of electrical and electronic switches and assemblies, circuit breakers, electronic controls, power distribution units, and multiplexed power distribution systems. With six ISO9001 and IATF16949 registered manufacturing facilities and technical sales offices worldwide, Carling Technologies Sales, Service and Engineering teams do much more than manufacture electrical components, they engineer powerful solutions! To learn more about Carling please visit www.carlingtech.com/company-profile.

To view all of Carling's environmental, quality, health & safety certifications please visit www.carlingtech.com/environmental-certifications.

© Carling Technologies, Inc.

9. Carling is a registered trademark of Carling Technologies, Inc. in the U.S. and other countries.

X-ON Electronics

Largest Supplier of Electrical and Electronic Components

Click to view similar products for [Toggle Switches](#) category:

Click to view products by [Carling](#) manufacturer:

Other Similar products are found below :

[8928K478](#) [8A1-C-222](#) [020017-13](#) [60012L](#) [6006L](#) [CS115W](#) [CS120W](#) [6663](#) [7101SPDV30BE](#) [7103SDV30BE](#) [7105D](#) [7108P3YAV2BE](#)
[71YY50282](#) [7300K36](#) [7301K38](#) [7306K36](#) [7310K36](#) [7506K4](#) [7592K6](#) [7660K12](#) [7691K14](#) [7700K1](#) [8391K108](#) [8396K108](#) [8811K17](#)
[8812K14](#) [8824K14](#) [8828K13](#) [8835K3](#) [8858K44](#) [PS83-121G](#) [1-1825192-0](#) [A201SCWZB04](#) [A207SYCB04](#) [A208J61ZQ0004](#) [A221T1TCQ](#)
[A323S1CWZQ](#) [A423S1CWZG-M8](#) [1201W](#) [12156AX408](#) [12147AGKX679](#) [12246X778](#) [12TW49-3D](#) [130312](#) [13037L](#) [13001X](#)
[AE101MD1W4B04](#) [AE208SD1W4B04](#) [MS24659-22D](#) [MS27407-5](#)