

3SS/3S1/3SM

3S-Series

SUB-MINIATURE PUSHBUTTONS

The 3S family of sub-miniature pushbutton switches is composed of three switch series; the **3S1-Series** sub-miniature pushbutton switch, the **3SS-Series** sealed sub-miniature pushbutton switch, and the **3SM-Series** surface mount sealed sub-miniature pushbutton switch. All switches are available with a variety of rating, termination and actuator choices, and will withstand temperatures from -30°C to +85°C.

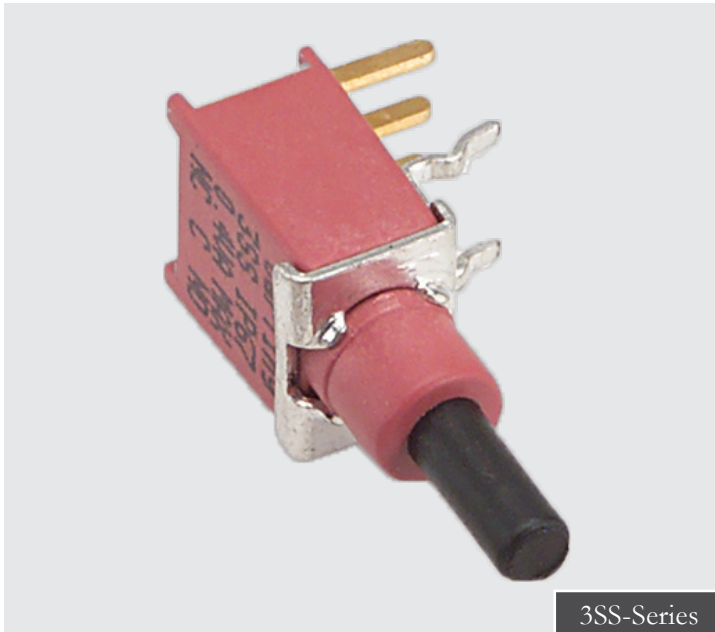

Product Highlights:

- IP67 Sealing
- AC or Low Voltage DC Rated
- Snap-in, PC or Surface Mounting
- Bulk Packed or Tape Reel

Typical Applications:

- Telecommunications
- Performance Audio
- Networking
- Computers
- Instrumentation
- Low Power On/Off Designs

Resources:

[Configure a Complete Part](#)

[Download CAD & Sales Drawing >](#)



Carling Technologies®

Innovative Designs. Powerful Solutions.

Carling Technologies, Inc.
60 Johnson Avenue, Plainville, CT 06062
Email: sales@carlingtech.com
Application Support: team2@carlingtech.com
Phone: 860.793.9281 Fax: 860.793.9231

www.carlingtech.com

3S1 - SP 9 - B6 - M7 - R E

1 Series 2 Poles 3 Circuit 4 Bushing 5 Termination 6 Contacts 7 Seal

1 SERIES
3S1 Sub-Miniature Pushbutton Switch

2 POLES
SP Single pole - uses terminals 1, 2 & 3

3 CIRCUIT
 () - momentary
Switching Position:

	1	2
	2-3, 5-6	2-1, 5-4
8	ON	(ON)
9	OFF	(ON)

Note: Plunger at rest in Position 1. Plunger depressed in Position 2.

4 BUSHING

B5 ¹	10-48 Threaded	B9	Flush Bushing
B6	Unthreaded "D"	B0	1/4" Unthreaded "D"
B7	Unthreaded	OP1	Snap-In with bezel
B8 ²	1/4-40 Threaded "D"	P0	Flush Plunger

5 TERMINATION

M1	Solder Lug	M7	PC Mount, 90° vertical
M2	PCB	M71	Snap-In, 90° vertical
M6	PC Mount, 90° horizontal	VS2	PC Mount, U bracket
M61	Snap-In, 90° horizontal	VS21	Snap-In, U bracket

See page 50-51 for dimensional specifications.

6 CONTACTS / TERMINALS

	Contact Material	Terminal Plating	Rating
G	silver ³	gold over silver	1A@125VAC or 28VDC
K	gold ^{4,7}	tin ⁶	0.4VA max @ 20V max (AC/DC)
P	silver ^{3,8}	tin ⁶	1A@125VAC or 28VDC
Q	silver ³	silver ³	1A@125VAC or 28VDC
R	gold ⁴	gold ⁵	0.4VA max @ 20V max (AC/DC)

7 EPOXY SEAL

E	Epoxy Seal	0	without Epoxy Seal
----------	------------	----------	--------------------

Notes:
 1 Hardware includes (2) 2M1-HDW21 nuts, and (1) 2M1-HDW22 washer
 2 Hardware includes (2) 2M1-HDW21 nuts, (1) 2M1-HDW22 washer, (1) 2M1-HDW11 washer, and (1) 2M1-HDW16 locking ring
 3 Movable contact and terminal platings: silver over copper alloy
 4 Movable contact and terminal platings: gold over nickel over copper alloy
 5 Terminal platings: gold over nickel over copper alloy
 6 Terminal platings: tin over copper alloy
 7 Terminal contact platings: Gold over nickel alloy
 8 Terminal contact platings: silver over nickel alloy

3SM - SP 9 - M6 - R E

1 Series 2 Poles 3 Circuit 4 Termination 5 Contacts 6 Seal 7 Packaging

1 SERIES
3SM Sealed Surface Mount Sub-Miniature Pushbutton Switch

2 POLES
SP Single pole - uses terminals 1, 2 & 3

3 CIRCUIT
 () - momentary
Switching Position:

	1	2
	2-3	2-1
8	ON	(ON)
9	OFF	(ON)

Note: Plunger at rest in Position 1. Plunger depressed in Position 2.

4 TERMINATION

K6	Surface Mount, horizontal .433 [11.00 mm]
M6	Surface Mount, 90° flat .286 [7.26 mm]
M7	Surface Mount, 90° right angle
S6	Surface Mount, 90° horizontal .353 [8.97 mm]

5 CONTACTS / TERMINALS

	Contact Material	Terminal Plating	Rating	Approvals
G	silver ¹	gold over silver	1A 125VAC or 28VDC	IP67
K	gold ^{2,5}	tin ⁴	0.4VA max 20V max (AC/DC)	IP67
P	silver ^{1,6}	tin ⁴	1A 125VAC or 28VDC	IP67
Q	silver ¹	silver ¹	1A 125VAC or 28VDC	IP67
R	gold ²	gold ³	0.4VA max 20V max (AC/DC)	IP67

6 EPOXY SEAL

E	Epoxy Seal	0	without Epoxy Seal
----------	------------	----------	--------------------

7 PACKAGING
T/R tape reel - 500 pieces per reel
 Switches are bulk packed, unless T/R is specified at the end of the part number.

Notes:
 1 Movable contact and terminals platings: silver over copper alloy
 2 Movable contact platings: gold over nickel over copper alloy
 3 Terminal platings: gold over nickel over copper alloy
 4 Terminals platings: tin over copper alloy
 5 Terminal contact platings: gold over nickel alloy
 6 Terminal contact platings: silver over nickel alloy

3S-Series Accessories

To order accessories assembled on a switch, specify the switch number followed by the accessory part number and the word "assembled".
 Ex: 3S1-SP9-B6-M7-RE-C23 ASSEMBLED. To order accessories in bulk, specify the Series, followed by the accessory. Ex: 3S1-C13.

Optional Cap

3S1 - C1 3

1 Series 2 Toggle Cap Size 3 Color

1 SERIES
3S1 Fits 3SS, 3S1 or 3MS

2 TOGGLE CAP SIZE

C1	.158" [4.01 mm] height	C2	.138" [35.05 mm] height
-----------	------------------------	-----------	-------------------------

3 CAP COLOR

1	White	5	Yellow
2	Black	6	Green
3	Red	7	Blue
4	Orange		

3SS-Series Dimensional Specifications: in. [mm]

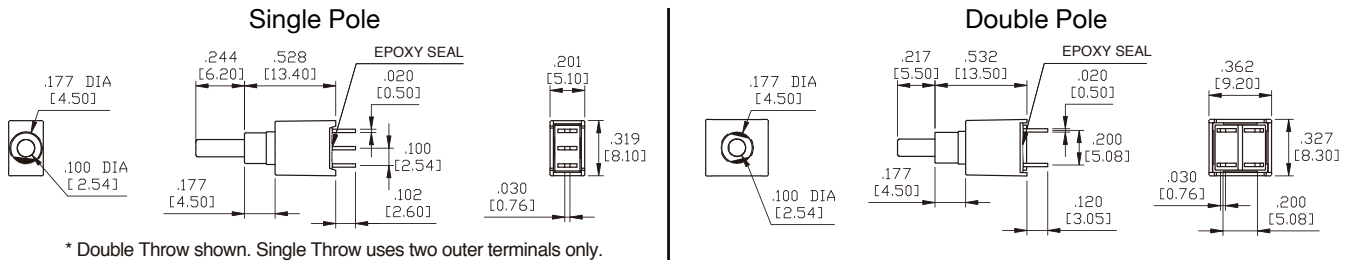

Termination Options

M6 Single Pole

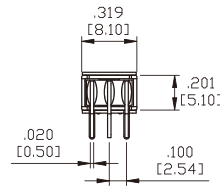
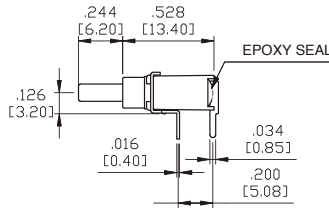
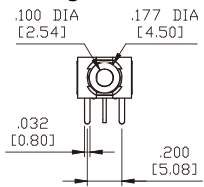

P.C.MOUNTING

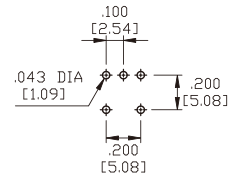

* Double Throw shown. Single Throw uses two outer terminals only.

M6 Double Pole

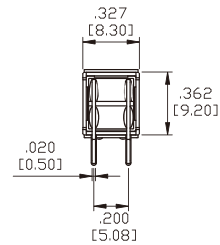
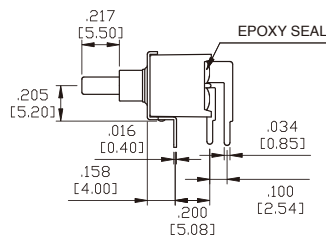
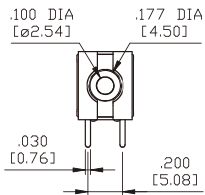

P.C.MOUNTING

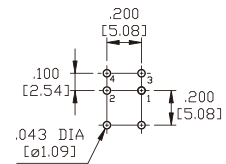

M7 Single Pole

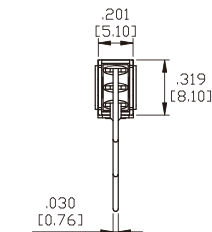
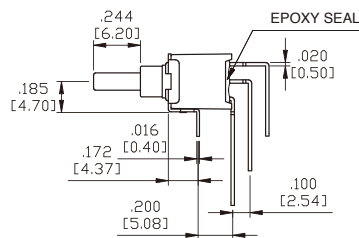
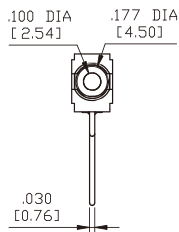

P.C.MOUNTING

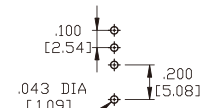

* Double Throw shown. Single Throw uses two outer terminals only.

M7 Double Pole

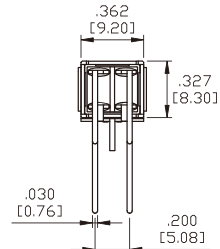
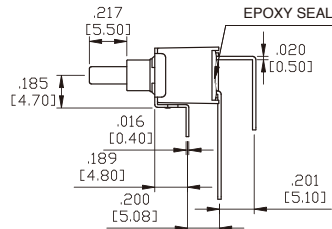
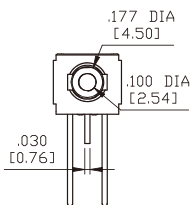

P.C.MOUNTING

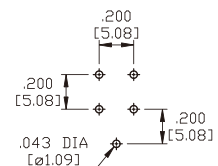

3SS-Series Dimensional Specifications: in. [mm]

Termination Options

VS2 Single Pole

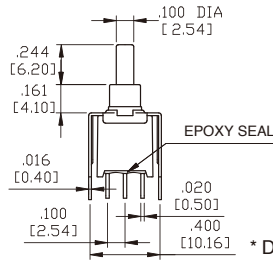
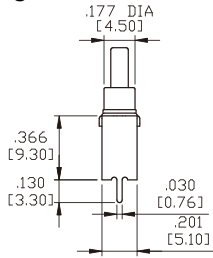

P.C. MOUNTING

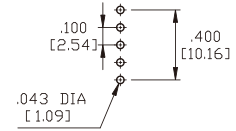

* Double Throw shown. Single Throw uses outer terminals only.

VS2 Double Pole

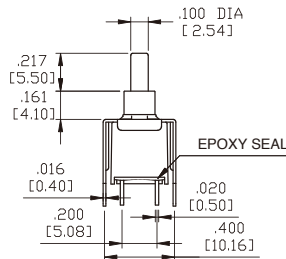
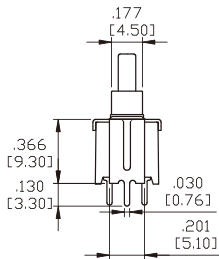

P.C. MOUNTING

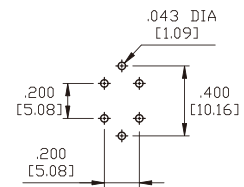

Snap-In Termination Options

M61

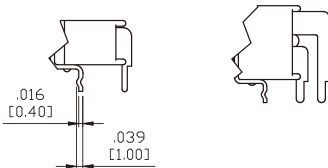

M71

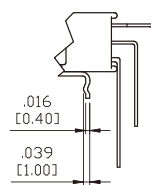

VS21

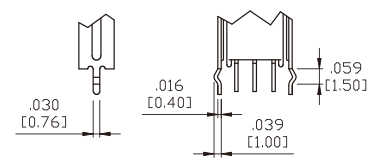

* PC Mounting for M61, M71, VS21 refer to M6, M7, VS2 respectively.

3S1-Series Dimensional Specifications: in. [mm]

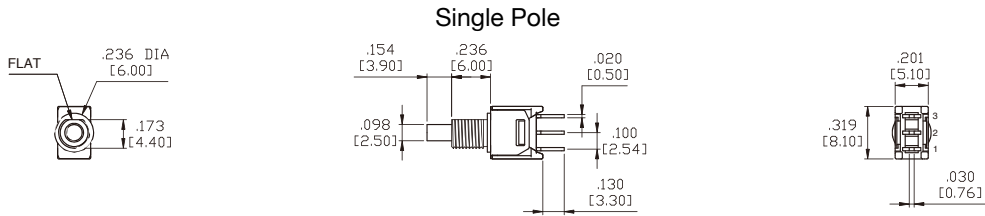

* Double Throw shown. Single Throw uses two outer terminals only.

Actuator Options for Snap-In Front Mount

OP1

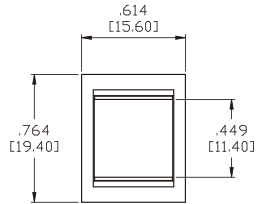
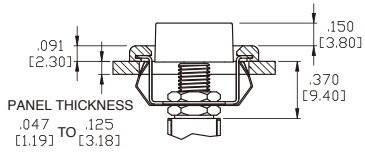

PANEL MOUNTING

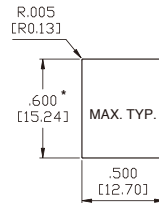

* Increase this dimension to .620/.625 [15.75/15.88] for .091/.125 [2.31/3.18] thk. panels.

OP1 Without Frame

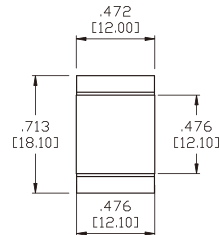
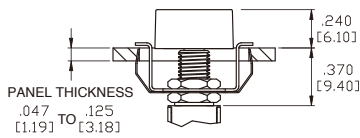

PANEL MOUNTING

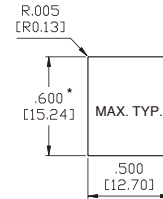

* Increase this dimension to .620/.625 [15.75/15.88] for .091/.125 [2.31/3.18] thk. panels.

Bushing Options

B5

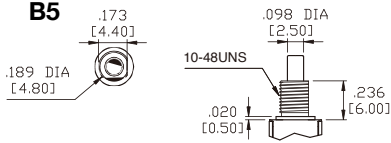

B6

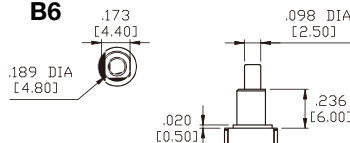

B7

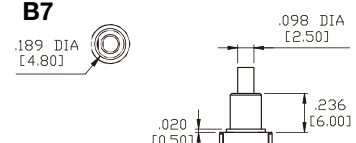

B8

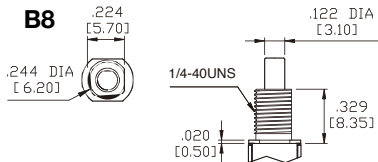

B9

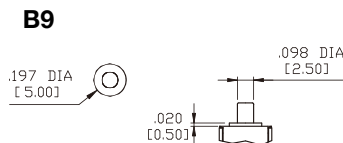

B0

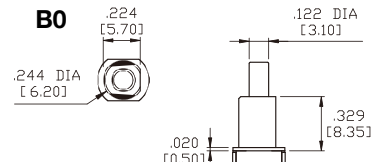

Termination Options

M1

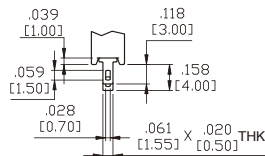

M2

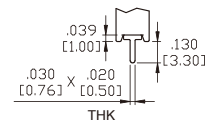

3S1-Series Dimensional Specifications: in. [mm]

Termination Options

M6 Single Pole

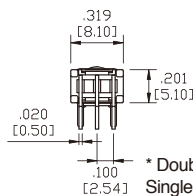
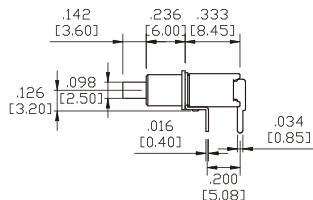
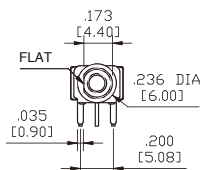

P.C.MOUNTING

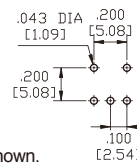

* Double Throw shown.
Single Throw uses two outer terminals only.

M7 Single Pole

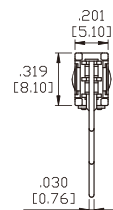
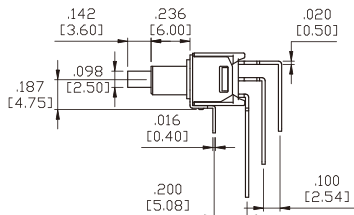
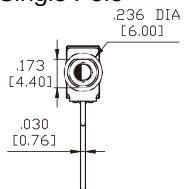

P.C.MOUNTING



* Double Throw shown.
Single Throw uses two outer terminals only.

VS2 Single Pole

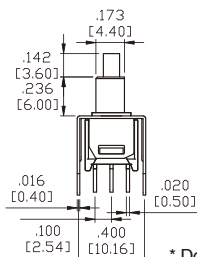
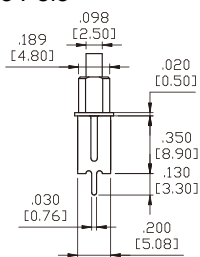

P.C.MOUNTING

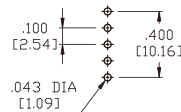

* Double Throw shown. Single Throw uses outer terminals only.

Snap-In Termination Options

M61

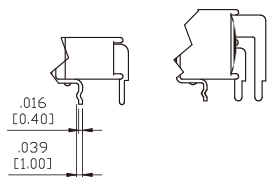

M71

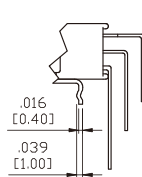

VS21

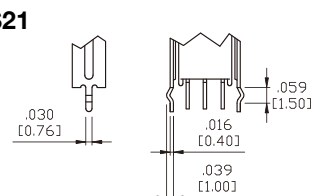

* PC Mounting for M61, M71, VS21 refer to M6, M7, VS2 respectively.

3SM-Series Dimensional Specifications: in. [mm]

K6 Single Pole

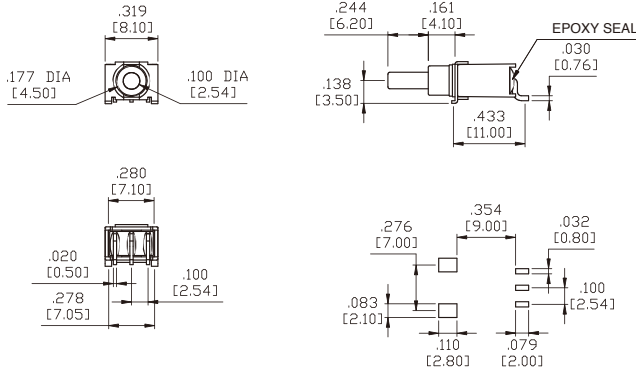

M6 Single Pole

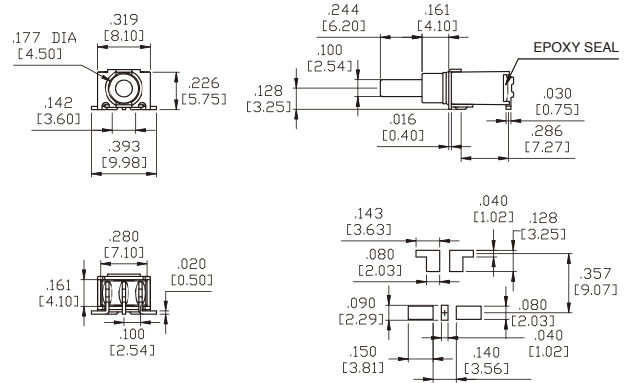

M7 Single Pole

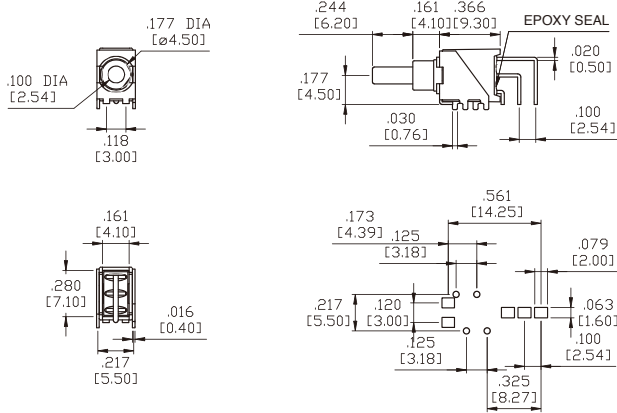

S6 Single Pole

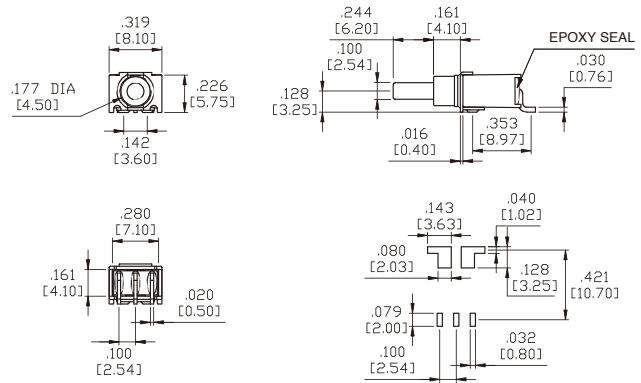

* Double Throw shown. Single Throw uses two outer terminals only.

Plunger Caps

C1

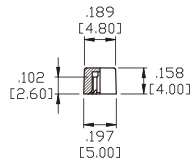

* MATERIAL: ABS.

C2

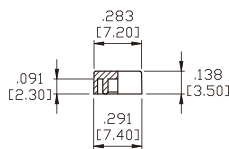

* MATERIAL: ABS.

CAP COLORS			
1	White	6	Green
2	Black	7	Blue
3	Red	8	Brown
4	Orange	9	Gray
5	Yellow		

Authorized Sales Representatives and Distributors

Click on a region of the map below to find your local representatives and distributors or visit www.carlingtech.com/findarep.



About Carling

Founded in 1920, Carling Technologies is a leading manufacturer of electrical and electronic switches and assemblies, circuit breakers, electronic controls, power distribution units, and multiplexed power distribution systems. With four ISO registered manufacturing facilities and technical sales offices worldwide, Carling Technologies Sales, Service and Engineering teams do much more than manufacture electrical components, they engineer powerful solutions! To learn more about Carling please visit www.carlingtech.com/company-profile.

To view all of Carling's environmental, quality, health & safety certifications please visit www.carlingtech.com/environmental-certifications

Worldwide Headquarters

Carling Technologies, Inc.
60 Johnson Avenue, Plainville, CT 06062
Phone: 860.793.9281 **Fax:** 860.793.9231
Email: sales@carlingtech.com

Northern Region Sales Office: nrsm@carlingtech.com
Southeast Region Sales Office: sersm@carlingtech.com
Midwest Region Sales Office: mrrsm@carlingtech.com
West Region Sales Office: wrsm@carlingtech.com
Latin America Sales Office: larsm@carlingtech.com

Asia-Pacific Headquarters

Carling Technologies, Asia-Pacific Ltd.,
Suite 1607, 16/F Tower 2, The Gateway,
Harbour City, 25 Canton Road,
Tsimshatsui, Kowloon, Hong Kong
Phone: Int + 852-2737-2277 **Fax:** Int + 852-2736-9332
Email: sales@carlingtech.com.hk

Shenzhen, China: shenzhen@carlingtech.com
Shanghai, China: shanghai@carlingtech.com
Pune, India: india@carlingtech.com
Kaohsiung, Taiwan: taiwan@carlingtech.com
Yokohama, Japan: japan@carlingtech.com

Europe | Middle East | Africa Headquarters

Carling Technologies LTD
4 Airport Business Park, Exeter Airport,
Clyst Honiton, Exeter, Devon, EX5 2UL, UK
Phone: Int + 44 1392.364422 **Fax:** Int + 44 1392.364477
Email: ltd.sales@carlingtech.com

Germany: gmbh@carlingtech.com
France: sas@carlingtech.com



Carling Technologies®

Innovative Designs. Powerful Solutions.

X-ON Electronics

Largest Supplier of Electrical and Electronic Components

Click to view similar products for [Switch Hardware](#) category:

Click to view products by [Carling](#) manufacturer:

Other Similar products are found below :

[893102000](#) [LZZ1A](#) [0098.9234](#) [61-9707.7](#) [61-9771.0](#) [M2PA-5011](#) [635401](#) [6PA104](#) [6PA113](#) [6PA147-E6](#) [6PA148-E6](#) [6PA32](#) [6PA9](#) [700106](#)
[700109](#) [700201A56](#) [700303A56](#) [700701264](#) [700C1GRY](#) [700C2GRN](#) [704-6001](#) [704.960.4](#) [704.960.9](#) [704.965.1](#) [704.965.2](#) [704.965.6](#)
[704.966.0](#) [7089-3](#) [71M1048](#) [757200264](#) [778000A56](#) [79215938](#) [MHU35](#) [MHU37](#) [825.003.011](#) [825.005.011](#) [825.053.011](#) [825.055.011](#)
[826.000.071](#) [827.020.011](#) [827.400.021](#) [835.900.023](#) [MML52C10C](#) [MML52E10C](#) [MML72EEK](#) [MML92HGH](#) [MML93K](#) [84211M02CNNS](#)
[84211M02LGRS](#) [84211M02LNNX3](#)