

B-Series

Hydraulic-Magnetic Circuit Breaker

PRODUCT WEBPAGE

request sample, configure part



Global Regulatory Safety Compliant

The B-Series hydraulic-magnetic circuit breakers are an optimal choice for both general purpose and full amp loads. These versatile breakers offer global regulatory safety approvals, a wide choice of actuator styles, time delays, terminals and imprinting options. The B-Series is configurable in one to six poles, rated up to 50 amps and 277VAC or 80VDC, with a max IC of 7,500 amps.

1-6 Poles **50** Amps Max **277** VAC Max **80** VDC Max

Typical Applications

- Power Supplies
- Generators & Welders
- Control Panels
- Marine
- Industrial Automation
- Medical Equipment
- Office Equipment
- Datacom/Telecom
- Military
- Commercial Food

Tech Specs

Electrical

Maximum Voltage	277VAC 50/60 Hz, 80VDC
Current Ratings	Standard current coils: 0.100, 0.250, 0.500, 0.750, 1.00, 2.50, 5.00, 7.50, 10.0, 15.0, 20.0, 25.0, 30.0, 35.0, 40.0 and 50.0 amps. Other ratings available, see ordering scheme.
Standard Voltage Coils	DC - 6V, 12V; AC - 120V, other ratings available, see ordering scheme.
Auxiliary Switch Rating	SPDT; 10.1 AMPS - 250VAC, 1.0A 65 VDC or 0.5A 80 VDC, 0.1 Amps - 125VAC (with gold contacts). VDE-1.0 Amp/25VAC.
Insulation Resistance	Minimum of 100 Megohms at 500 VDC.
Dielectric Strength	UL, CSA-1500 V 50/60 Hz for one minute between all electrically isolated terminals. B-Series circuit breakers comply with the 8mm spacing and 3750V 50/60 Hz dielectric requirements from hazardous voltage to operator accessible surfaces, between adjacent poles and from main circuits to auxiliary circuits per Publications EN 60950 and VDE 0805.
Resistance, Impedance	Values from Line to Load Terminal - based on Series Trip Circuit Breaker.

RESISTANCE PER POLE VALUES
from Line to Load Terminals
(Values Based on Series Trip Circuit Breaker)

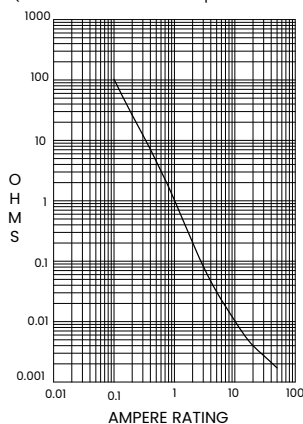

CURRENT (AMPS)	TOLERANCE (%)
0.10 - 5.0	15
5.1 - 20.0	25
20.1 - 50.0	35

Pulse Tolerance Curves

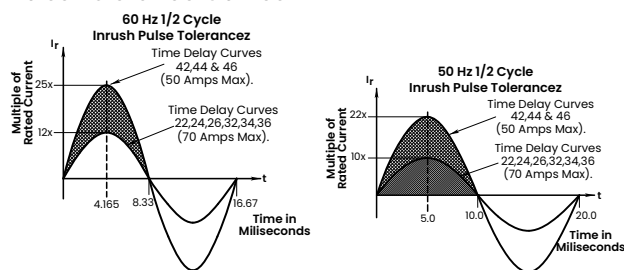

Mechanical

Endurance	10,000 ON-OFF operations @ 6 per minute; with rated Current & Voltage.
Trip Free	All B-Series Circuit Breakers will trip on overload, even when Handle is forcibly held in the ON position.
Trip Indication	The operating Handle moves positively to the OFF position when an overload causes the breaker to trip.
Number of Poles	1 - 6 poles at 30 Amps or less. 1 and 2 poles at 31 Amps thru 50 Amps.
Internal Circuit Config.	Series, (with or without auxiliary switch), Shunt and Relay with current or voltage trip coils, Dual Coil, Switch Only (with or without auxiliary switch).
Weight	Approximately 65 grams/pole.
Standard Colors	Housing- Black; Actuator - See Ordering Scheme.

Physical

Environmental

Designed and tested in accordance with requirements of specification MIL-PRF-55629 & MIL-STD-202 as follows:

Shock	Withstands 100 Gs, 6ms, sawtooth while carrying rated current per Method 213, Test Condition "I". Instantaneous and ultra-short curves tested @ 90% of rated current.
Vibration	Withstands 0.060" excursion from 10-55 Hz, and 10 Gs 55-500 Hz, at rated current per Method 204C, Test Condition A. Instantaneous and ultrashort curves tested at 90% of rated current.
Moisture Resistance	Method 106D, i.e., ten 24-hour cycles @ +25°C to +65°C, 80-98% RH.
Salt Spray	Method 101, Condition A (90-95% RH @ 5% NaCl Solution, 96 hrs).
Thermal Shock	Method 107D, Condition A (Five cycles @ -55°C to +25°C to +85°C to +25°C).
Operating Temperature	-40° C to +85° C

Tech Specs

Tables

Table A: Lists UL Recognized & CSA Certified configurations and performance capabilities as a Component Supplementary Protector.

Component Supplementary Protectors														
Circuit Configuration	Voltage			Current Rating		Short Circuit Capacity (Amps)		Application Codes		Construction Notes				
	Max Rating	Frequency	Phase	Full Load Amps	General Purpose Amps	UL/CSA		UL	CSA					
						With Backup Fuse	Without Backup Fuse							
Series	65	DC	-	31-50	-	-	-	TC1,2, OL1,U1	TC1,2, OL1,U1	-				
	80			0.02-30							7500	TC1,2, OL1,U1	TC1,2, OL1,U1	
				-										31-50
	125	50/60	1	1-50	-			2000	TC1, OL1,U2		TC1, OL1,U2			
				1 ⁴				1000	TC1, OL1,U2		TC1, OL1,U3			
	125/250			1 ³				3000	TC1,2, OL1,U1		TC1,2, OL1,U1			
	250			1				0.02-30	1500		TC1, OL0,U2	TC1, OL0,U2	Single Pole Breaker	
								-	3000		TC1, OL1,U2	TC1, OL1,U2	Two Pole Break	
								1 ⁴	1-50		1000	TC1, OL1, U2	TC3, OL1,U3	
								3	0.02-30		5000 ²	TC1,2, OL1,C1	TC1,2, OL1,C1	
								-	31-50		2000 ¹	TC1,2, OL1, C1	TC1,2, OL1,C1	
	277							1	-		5000 ¹	TC1,2, OL1,C1	TC1,2, OL1,C1	
Dual Coil	65	DC	-	0.02-30	-	-	-	TC1,2, OL1,U1	TC1,2, OL1,U1	-				
	80			-							31-50	7500	TC1,2, OL1,U1	TC1,2, OL1,U1
				-							31-50			
	125	50/60	1	1-50	-			2000	TC1, OL1,U2		TC1, OL1,U2			
	125/250			1 ³				0.02-30	3000		TC1,2, OL1,U1	TC1,2, OL1,U1		
	250			1				0.02-30	1500		TC1, OL0,U2	TC1, OL0,U2	Single Pole Breaker	
								-	3000		TC1, OL1,U2	TC1, OL1,U2	Two Pole Break	
								1 ⁴	1-50		1000	TC1,2, OL0,U2	TC1,2, OL0,U2	
								3	0.20-30		5000 ³	TC1,2, OL1,C1	TC1,2, OL1,C1	
								-	31-50		2000 ¹	TC1,2, OL1,C1	TC1,2, OL1,C1	
	277							1	-		5000 ¹	TC1,2, OL1,U1	TC1,2, OL1,U1	
	Shunt			80				DC	-		0.02-30	-	-	-
125/250		1 ³	3000	TC1,2, OL1,U1	TC1,2, OL1,U1									
250		50/60				1	-	TC1,2, OL1,U1	TC1,2, OL1,U1					
			3	5000 ²	TC1,2, OL1,U1	TC1,2, OL1,U1								
			1	5000 ¹	TC1,2, OL1,U1	TC1,2, OL1,U1								
277		1	-	5000 ¹	TC1,2, OL1,U1	TC1,2, OL1,U1								
Relay	80	DC	-	0.02-30	-	-	-	7500	TC1,2, OL1,U1	-				
	125/250										1 ³	3000	TC1,2, OL1,U1	TC1,2, OL1,U1
	250	50/60	1					-	TC1,2, OL1,U1		TC1,2, OL1,U1			
			3									5000 ²	TC1,2, OL1,U1	TC1,2, OL1,U1
			1									5000 ¹	TC1,2, OL1,U1	TC1,2, OL1,U1
277		1	-	5000 ¹	TC1,2, OL1,C1	TC1,2, OL1,C1								
Switch Only	65	DC	-	-	31-50	-	-	-	-	-				
	80			-							31-50	-	-	
	250	50/60	1	-	-									
			3	0.02-30	-									
277		1	0.02-30	31-50										

Notes:

- Requires branch circuit backup with a UL LISTED Type K5 or RK5 fuse (15A minimum) at no more than 4 times the rating of the protector.
- Same as note 1, except that backup fuse is limited to 80A maximum.
- 2 pole protector required (with one pole per power line) for: 250/125 VAC, 125/250 VAC and 208Y/120 VAC Power Systems. 1 pole protector required for : 125 VAC, 1Ø Power System.
- Satisfies the requirements of clause 11.2.8.2.5 of CSA STD C22.2 No 100 for the use of supplementary protectors with portable generators.

Tech Specs

Tables

Table B: Lists UL Recognized, CSA, VDE & TUV Certified configurations & performance capabilities as a Component Supplementary Protector.

Component Supplementary Protectors																				
Circuit Configuration	Voltage			Current Rating		Short Circuit Capacity (Amps)						Application Codes		Construction Notes						
	Max Rating	Frequency	Phase	Full Load Amps	General Purpose Amps ¹	UL/CSA		VDE		TUV		UL	CSA							
						With Backup Fuse	Without Backup Fuse	(Inc) With Backup Fuse	(Inc) Without Backup	(Inc) with Backup Fuse	(Inc) Without Backup									
Series	80	DC	-	0.10-30	-	-	7500	3000	1500	3000	1500	TC1,2, OL1,U1	TC1,2, OL1,U1							
				31-50	31-50							TC1,2, OL0,U1	TC1,2, OL0,U1							
				0.10-30	-							TC1,2, OL1,U1	TC1,2, OL1,U1							
				31-32	-							TC1,2, OL1,U1	TC1, OL1,U1							
				31-50	31-50							TC1,2, OL0,U1	TC1,2, OL0,U1							
	250	50/60	1	0.10-30	-	-	3000	-	-	5000		TC1,2, OL1,U1	TC1,2, OL1,U1							
				31-50	31-50							TC1, OL0,U1	TC1, OL0,U1							
				31-32	-							TC1, OL1,U1	TC1, OL1,U1							
				3	-		-	0.10-30	-	-		-	3000	1500	3000	TC1,2, OL0,U2	TC1, OL0,U2	Single Pole Breaker		
																TC1, OL1, U2	TC1, OL1,U2	Two Pole Break		
																TC1,2, OL1,U1	TC1,2, OL1,U1			
																TC1,2, OL1, U1	TC1,2, OL1,U1			
415	50/60	3	-	-	5000 ³	1000	3000	1500	3000	TC1,2, OL1, U1	TC1,2, OL1,U1									
80	DC	-								TC1,2, OL0,U1	TC1,2, OL0,U1									
Dual Coil	250	50/60	1	30-50	31-50	-	3000	-	-	5000	TC1,2, OL1,U1	TC1,2, OL1,U1								
				0.10-30	-						5000 ³	-	3000	1500	TC1,2, OL0,U1	TC1,2, OL0,U1				
			3	-	-		0.10-30	-	-	-	-	-	3000	TC1,2, OL1,C1	TC1,2, OL1,C1					
							31-50	-						2000 ²	-	-	-	TC1,2, OL1,C1	TC1,2, OL1,C1	
							TC1,2, OL1,U1	TC1,2, OL1,U1												
Shunt	80	DC	-	0.10-30	-	-	7500	3000	1500	5000	TC1,2, OL1,U1	TC1,2, OL1,U1								
				30-50	31-50						3000	-	-	5000	TC1,2, OL1,U1	TC1,2, OL1,U1				
				0.10-30	-						5000 ³	-	3000	1500	3000	TC1,2, OL0,U1	TC1,2, OL0,U1			
	250	50/60	1	0.10-30	-	-	-	3000	1500	3000	TC1,2, OL1,C1	TC1,2, OL1,C1								
				31-50	-						2000 ²	-	-	-	TC1,2, OL1,C1	TC1,2, OL1,C1				
				TC1,2, OL1,U1	TC1,2, OL1,U1															

Notes:

- 1 General Purpose Ratings for UL/CSA Only.
- 2 Requires branch circuit backup with a UL LISTED Type K5 or RK5 fuse (15A minimum) at no more than 4 times the rating of the protector.
- 3 Same as note 1, except that backup fuse is limited to 80 A maximum.

Table C: Lists UL Recognized, CSA Certified configurations and performance capabilities as Protectors, Supplementary for Marine Electrical and Fuel Systems (CCN/Guide PEQZ2, File E75596). Ignition Protected per UL 1500. UL Classified Small Craft Electrical Devices, Marine in accordance with ISO 8846 (CCN/Guide UZMK, File MQ1515) as Marine Supplementary Protectors.

UL1500 (Marine Ignition Protection)							
Circuit Configuration	Voltage			Current Rating	Short Circuit Capacity (Amps)	Application Codes	
	Max Rating	Frequency	Phase	Full Load Amps	Without Backup Fuse	UL	CSA
Series	14 ¹	DC	-	0.02-50	5000	TC1,2, OL1,U1	TC1,2, OL1,U1
	32 ¹					TC1,2, OL0,U2	TC1,2, OL0,U2
	65				TC1,2, OL1,U1	TC1,2, OL1,U1	
	125/250	50/60	1 ²		1500	TC1,2, OL1,U1	TC1,2, OL1,U1
	250		1		1000	TC1,2, OL1,U1	TC1,2, OL1,U1

Notes:

- 1 Available with special catalog number only (consult factory).
- 2 pole protector required (with one pole per power line) for: 250/125 VAC, 125/250 VAC and 208V/120 VAC Power Systems. 1 pole protector required for : 125 VAC, 10 Power System.

Tech Specs

Tables

Table D: Lists UL Listed configurations and performance capabilities as Circuit Breakers for use in Communications Equipment (CCN/Guide DITT, File E189195), under UL489A

UL489A (Communication Equipment)				
Circuit Configuration	Voltage		Current Rating	Interrupting Capacity (Amps)
	Max Rating	Frequency	General Purpose Amps	Without Backup Fuse
Series	80	DC	0.10-50	5000
			60-90 ¹	

Notes:
¹ Parallel Pole Construction

Table E: Lists UL Listed (489) configuration and performance capabilities as a Molded Case Circuit Breaker.

UL489 Listed Branch Circuit Breakers						
Circuit Configuration	Voltage			Current Rating	Interrupting Capacity (Amps)	Construction Notes
	Max Rating	Frequency	Phase	Full Load Amps	Without Backup Fuse	
Series	120	50/60	1	0.10 - 30	5,000	1 pole
	120/240					2 pole
	120/240					2 or 3 poles (1 Pole of a 3 Pole Unit is for Neutral Break)
Dual Coil	120	50/60	1	0.10 - 30	5,000	1 pole
	120/240					2 pole
	120/240					2 or 3 poles (1 Pole of a 3 Pole Unit is for Neutral Break)

Time Delay Specs

To view all hydraulic-magnetic circuit breaker time delay values, please visit www.carlingtech.com/sites/default/files/documents/Carling-HM-CB-Time-Delays.pdf

Agency Approvals

UL 1077	Component Recognition Program as Protectors Supplementary (Guide CCN/QVNU2, File E75596)
UL 508	Switches, Industrial Control (Guide CCN/NRNT2, File E148683)
UL 1500	Protectors, Supplementary for Marine Electrical & Fuel Systems (Guide PEQZ2, File E75596) Ignition Protection
UL 489	Circuit Breakers, Molded Case, (Guide DIVQ, File E129899)
UL 489A	Communications Equipment (Guide CCN/DITT, File E189195)
CSA Accepted	Component Supplementary Protector under Class 3215 30, File 047848 0 000 CSA Standard C22.2 No. 235
TUV Certified	EN60934, under License No. R72103448
VDE Certified	EN60934, VDE 0642 under File No. 10537

Ordering Scheme

Handle - UL 1077 Recognized

Sample Part Number **B A 3 - B 0 - 10 - 450 - 1 B 1 - C**

Selection 1 2 3 4 5 6 7 8 9 10 11

1. SERIES

B

2. ACTUATOR ¹

A Handle, one per pole
 B Handle, one per multipole unit
 S Mid-Trip Handle, one per pole
 T Mid-Trip Handle, one per pole & Alarm Switch

3. POLES

1 One 3 Three 5 Five
 2 Two 4 Four 6 Six

4. CIRCUIT

A Switch Only (No Coil) ² G Relay Trip (Voltage) ³
 B Series Trip (Current) H Dual Coil with Shunt Trip ^{3,4}
 C Series Trip (Voltage) Voltage Coil
 D Shunt Trip (Current) ³ K Dual Coil with Relay Trip ^{3,4}
 E Shunt Trip (Voltage) ³ Voltage Coil
 F Relay Trip (Current) ³

5. AUXILIARY / ALARM SWITCH ⁵

0 without Aux Switch 7 S.P.S.T., 0.110 Q.C. Term.
 2 S.P.D.T., 0.110 Q.C. Term. 8 S.P.S.T., 0.187 Q.C. Term.
 (Gold Contacts) (Gold Contacts)
 4 S.P.D.T., 0.110 Q.C. Term. 9 S.P.D.T., 0.187 Q.C. Term.

6. FREQUENCY & DELAY

03 DC 50/60Hz, Switch Only ² 30 DC, 50/60Hz Instantaneous
 10 DC Instantaneous ⁶ 31 DC, 50/60Hz Ultra Short
 11 DC Ultra Short 32 DC, 50/60Hz Short
 12 DC Short 34 DC, 50/60Hz Medium
 14 DC Medium 36 DC, 50/60Hz Long
 16 DC Long 42 50/60Hz Short, High-inrush ⁷
 20 50/60Hz Instantaneous 44 50/60Hz Medium, High-inrush ⁷
 21 50/60Hz Ultra Short 46 50/60Hz Long, High-inrush ⁷
 22 50/60Hz Short 52 DC, Short, High-inrush ⁷
 24 50/60Hz Medium 54 DC, Medium, High-inrush ⁷
 26 50/60Hz Long 56 DC, Long, High-inrush ⁷

Notes:

- Actuator Code: A: Handle tie pin spacer(s) and retainers provided unassembled with multi-pole units.
 B: Handle location as viewed from front of breaker.
 2 pole - left pole 3 pole - center pole
 4 pole - two handles at center poles 5 pole - three handles at center poles
 6 pole - four handles at center poles
 S: Handle moves to mid-position only upon electrical trip of the breaker. Available with circuit codes B, C, D, E, F, G, H and K.
 T: Handle moves to mid-position and alarm switch activates only upon electrical trip of the breaker. Available with circuit codes B & C.
- Switch Only circuits, rated up to 50A and 6 poles, and only available with VDE Certification when tied to a protected pole (Circuit Code B, C, D or H.), For .02 to 30 A, select Current Code 630. For 35 - 50A, select Current Code 650.
- Available with Terminal Codes 1, 2 & 3. Current Rating limited to 30A maximum.
- Consult factory for available Dual Coil options, as special catalog number is required. With Shunt construction, Dual Coils will trip instantaneously on line voltage. Dual coils require 30VA minimum power to trip and are rated for intermittent duty only.
- Auxiliary Switch breakers with Series Trip and Switch Only circuits. On multi-pole breakers, one auxiliary switch is supplied, mounted in the extreme right pole.
- Separate pole type voltage coils not rated for continuous duty. Available only with delay codes 10 and 20.
- Available with Circuit Codes B & D only. VDE Certified to 30A. UL Recognized and CSA Accepted to 50A.
- VDE Certification available with single pole breakers with DC Delay only. UL Recognition and CSA Accepted available in one and two pole breakers.
- Screw Terminals are recommended on ratings greater than 20 A. Ratings over 30 A are only available with Terminal Codes 5, 9, G, H, J, K, M and Q.
- VDE Certification up to 25 A and UL Recognition and CSA Acceptance up to 30 A, but not recommended over 20A.
- Terminal Codes 3, 5 E and H (Bus Type) with VDE, are supplied with Lock Washers, and Terminal Code M (M6 Threaded Stud) with VDE is supplied with Lock and Flat Washers. These breakers are only VDE Certified when the washers are used.
- VDE available up to 12A. UL Rec. & CSA Acceptance available up to 30A.
- 1-Pole breakers with Terminal Code P (Printed Circuit Board) available up to 30A with VDE and 50A with UL Recognition & CSA Acceptance, Circuit Codes A, B & C. Two pole breakers with Terminal Code P (Printed Circuit Board) are available up to 40A with UL Recognition and CSA Acceptance with Circuit Codes A, B and C.
- Available with Actuator Codes A, S and T.
- Available with voltage coils only.
- Terminal Code Q not available with VDE approvals.

[Configure Complete Part Number >](#)

[Browse Standard Parts >](#)

7. CURRENT RATING (AMPERES)

CODE	AMPERES						
020	0.020	225	0.250	420	2.000	611	11.000
025	0.025	230	0.300	522	2.250	711	11.500
030	0.030	235	0.350	527	2.750	612	12.000
035	0.035	240	0.400	430	3.000	712	12.500
040	0.040	245	0.450	435	3.500	613	13.000
045	0.045	250	0.500	440	4.000	614	14.000
050	0.050	255	0.550	445	4.500	615	15.000
055	0.055	260	0.600	450	5.000	616	16.000
060	0.060	265	0.650	455	5.500	617	17.000
065	0.065	270	0.700	460	6.000	618	18.000
070	0.070	275	0.750	465	6.500	620	20.000
075	0.075	280	0.800	470	7.000	622	22.000
080	0.080	285	0.850	475	7.500	624	24.000
085	0.085	290	0.900	480	8.000	625	25.000
090	0.090	295	0.950	485	8.500	630	30.000
095	0.095	410	1.000	490	9.000	635	35.000 ⁸
210	0.100	512	1.250	495	9.500	640	40.000 ⁸
215	0.150	415	1.500	610	10.000	645	45.000 ⁸
220	0.200	517	1.750	710	10.500	650	50.000 ⁸

OR VOLTAGE COIL (NORMAL RATED VOLTAGE) ⁶

A06	6 DC	A32	32 DC	J12	12 AC	J65	65 AC
A12	12 DC	A48	48 DC	J18	18 AC	K20	120 AC
A18	18 DC	A65	65 DC	J24	24 AC	L40	240 AC
A24	24 DC	J06	6 AC	J48	48 AC		

8. TERMINAL ⁹

1 ¹⁰	Push-On 0.250 Tab (Q.C.)	E ¹¹	Screw M4 (Bus Type)
2	Screw 8-32 with upturned lugs	G	Screw M5 (Bus Type) & 30° bend
3 ¹¹	Screw 8-32 (Bus Type)	H	Screw M5 (Bus Type)
4	Screw 10-32 with upturned lugs	J	Screw M5 Back Connect
5 ¹¹	Screw 10-32 (Bus Type)	K	Screw 10-32 Back Connect
6	Screw 8-32 with upturned lugs & 30° bend	L ¹²	0.250 Q.C./ Solder Lug
7	Screw 8-32 (Bus Type)	M ¹¹	M6 Threaded Stud
8	Screw 10-32 with upturned lugs & 30° bend	N	Screw M4 Back Connect & 30° bend
9	Screw 10-32 (Bus Type) & 30° bend	P ¹³	Printed Circuit Board Terminals
B	Screw M5 with upturned lugs	Q ¹⁶	Push-In Stud & 30° bend
C	Screw, M4 with upturned lugs	R	Screw M4 with upturned lugs & 30° bend
		S ¹⁵	Push-On 0.110 Tab (Q.C.)
		T	Screw M4 (Bus Type) & 30° bend
		Y	Screw 8-32 Back Connect

9. ACTUATOR COLOR & LEGEND

Actuator Color	I-O	ON-OFF	Dual	Legend Color
White	A	B	1	Black
Black	C	D	2	White
Red	F	G	3	White
Green	H	J	4	White
Blue	K	L	5	White
Yellow	M	N	6	Black
Gray	P	Q	7	Black
Orange	R	S	8	Black

10. MOUNTING / BARRIERS

	MOUNTING STYLE	BARRIERS
	Threaded Insert, 2 per pole	
1	6-32 x 0.195 inches	no
A	6-32 x 0.195 inches (multi-pole units only)	yes
2	ISO M3 x 5mm	no
B	ISO M3 x 5mm	yes
	Rectangular Adapter Plate with mounting centers of 2.062 inches [52.37mm] and Threaded insert, 2 per pole	
3 ¹⁴	6-32 x 0.225 inches	no
C ¹⁴	6-32 X 0.225 inches (multi-pole units only)	yes
4 ¹⁴	ISO M3 x 6.5mm	no
D ¹⁴	ISO M3 x 6.5mm	yes
	Front panel Snap-In, 0.75" [19.05mm] wide bezel	
5	without Handleguard	no
6	without Handleguard (multi-pole units only)	yes
	Front panel Snap-In, 0.96" wide bezel	
7	without Handleguard, 1-pole 0.96" wide; multipole units have .105" bezel overhang on all sides	no
8	without Handleguard, 1-pole 0.96" wide; (multipole only) .105" bezel overhang on all sides	yes

11 AGENCY APPROVAL

C	UL Recognized & CSA Accepted
D	VDE Certified, UL Recognized & CSA Accepted
E	TUV Certified, UL Recognized & CSA Accepted
I	UL Recognized STD 1077, UL Recognized 1500 (ignition protected), & CSA Accepted

Ordering Scheme

Handle - UL 489A Listed

Sample Part Number

B A 1 - B 0 - 14 - 450 - 1 B 1 - M T

Selection 1 2 3 4 5 6 7 8 9 10 11 12

1. SERIES

B

2. ACTUATOR ¹

- A** Handle, one per pole
- B** Handle, one per multi-pole unit
- S** Mid-Trip Handle, one per pole
- T** Mid-Trip Handle, one per pole & Alarm Switch A Handle, one per pole
- B** Handle, one per multi-pole unit
- S** Mid-Trip Handle, one per pole
- T** Mid-Trip Handle, one per pole & Alarm Switch

3. POLES ²

- 1** One
- 2** Two
- 3** Three
- 4** Four

4. CIRCUIT

- B** Series Trip (Current)

5 AUXILIARY/ALARM SWITCH ²

- 0** without Aux Switch
- 2** S.P.D.T., 0.110 Q.C. Term.
- 3** S.P.D.T., 0.110 Solder lug.
- 7** S.P.S.T., 0.110 Q.C. Term. (Gold Contacts)
- 8** S.P.S.T., 0.187 Q.C. Term.
- 9** S.P.S.T., 0.187 Q.C. Term.

6 FREQUENCY & DELAY ⁴

- 11** DC Ultra Short
- 12** DC Short
- 14** DC Medium
- 16** DC Long
- 52** DC, Short, High-inrush
- 54** DC, Medium, High-inrush
- 56** DC, Long, High-inrush

7. CURRENT RATING (AMPERES)

CODE	AMPERES							
210	0.100	285	0.850	455	5.500	613	13.000	
215	0.150	290	0.900	460	6.000	614	14.000	
220	0.200	295	0.950	465	6.500	615	15.000	
225	0.250	410	1.000	470	7.000	616	16.000	
230	0.300	512	1.250	475	7.500	617	17.000	
235	0.350	415	1.500	480	8.000	618	18.000	
240	0.400	517	1.750	485	8.500	620	20.000	
245	0.450	420	2.000	490	9.000	622	22.000	
250	0.500	522	2.250	495	9.500	624	24.000	
255	0.550	527	2.750	610	10.000	625	25.000	
260	0.600	430	3.000	710	10.500	630	30.000	
265	0.650	435	3.500	611	11.000	635 ³	35.000	
270	0.700	440	4.000	711	11.500	640 ³	40.000	
275	0.750	445	4.500	612	12.000	645 ³	45.000	
280	0.800	450	5.000	712	12.500	650 ³	50.000	

8. TERMINAL ⁴

- 1**⁵ Push-On 0.250 Tab (Q.C.)
- 2** Screw 8-32 with upturned lugs
- 3**⁶ Screw 8-32 (Bus Type)
- 4** Screw 10-32 with upturned lugs
- 5**⁶ Screw 10-32 (Bus Type)
- 6** Screw 8-32 with upturned lugs & 30° bend
- 7** Screw 8-32 (Bus Type) & 30° bend
- 8** Screw 10-32 with upturned lugs & 30° bend
- 9** Screw 10-32 (Bus Type) & 30° bend
- B** Screw M5 with upturned lugs
- F** Screw M5 with upturned lugs & 30° bend
- G** Screw M5 (Bus Type) & 30° bend
- H** Screw M5 (Bus Type)
- J** Screw M5 Back Connect
- K** Screw 10-32 Back Connect
- M**⁶ M6 Threaded Stud
- N** Screw M4 Back Connect & 30° bend
- P**⁷ Printed Circuit Board Terminals
- Q**⁸ Push-In Stud & 30° bend
- Y** Screw 8-32 Back Connect

9 ACTUATOR COLOR & LEGEND

Actuator Color	ON-OFF	Dual	Legend Color
White	B	1	Black
Black	D	2	White
Red	G	3	White
Green	J	4	White
Blue	L	5	White
Yellow	N	6	Black
Gray	Q	7	Black
Orange	S	8	Black

10. MOUNTING / BARRIERS

	MOUNTING STYLE	BARRIERS
	Threaded Insert, 2 per pole	
1	6-32 x 0.195 inches	no
A	6-32 x 0.195 inches (multi-pole units only)	yes
2	ISO M3 x 5mm	no
B	ISO M3 x 5mm	yes
	Rectangular Adapter Plate with mounting centers of 2.062 inches [52.37mm] and Threaded insert, 2 per pole	
3	6-32 x 0.225 inches	no
C	6-32 X 0.225 inches (multi-pole units only)	yes
4	ISO M3 x 6.5mm	no
D	ISO M3 x 6.5mm	yes
	Front panel Snap-In, 0.75" [19.05mm] wide bezel	
5	without Handleguard	no
6	without Handleguard (multi-pole only)	yes
	Front panel Snap-In, 0.96" wide bezel	
7	without Handleguard	no
8	without Handleguard (multi-pole only)	yes
	.105" bezel overhang on all sides, for multi-pole units.	

11. MAXIMUM APPLICATION RATING

- M** 80 DC

12. AGENCY APPROVAL

- T** UL489A Listed
- K** UL489A Listed, VDE Certified
- J** UL489A Listed, TUV Certified

Notes:

- 1 Actuator Code:
A: Handle tie pin spacer(s) and retainers provided unassembled with multi-pole units.
S: Handle moves to mid-position only upon electrical trip of the breaker.
T: Handle moves to mid-position and alarm switch activates only upon electrical trip of the breaker.
- 2 On multi-pole breakers, one auxiliary switch is supplied, mounted in the extreme right pole.
- 3 VDE Certification available with single pole breakers only. UL489A Listing available with one and two pole breakers.
- 4 Screw Terminals are recommended on ratings greater than 20 amps. Ratings over 30 amps are only available with Terminal Codes 5, 9, G, H, J, K, M and Q.
- 5 Terminal Code I (Push-On) available up to 25 amps with TUV or VDE Certification and 30 amps with UL489A Listing, but is not recommended over 20 amps.
- 6 Terminal Codes 3, 5 and H (Bus Type) with TUV or VDE, are supplied with Lock Washers, and Terminal Code M (M6 Threaded Stud) with TUV or VDE is supplied with Lock and Flat Washers. These breakers are only TUV or VDE Certified when the washers are used.
- 7 Single pole breakers with Terminal Code P (Printed Circuit Board) are available up to 30 amps with VDE Certification and 50 amps with UL489A Listing.
- 8 Terminal Code Q not available with VDE approvals.

[Configure Complete Part Number >](#)

[Browse Standard Parts >](#)

Ordering Scheme Handle - UL 489 Listed

Sample Part Number **B A 1 - B 0 - 24 - 450 - 1 B A - K G**

Selection 1 2 3 4 5 6 7 8 9 10 11 12

1. SERIES

B

2. ACTUATOR ¹

A Handle, one per pole
 B Handle, one per multi-pole unit
 S Mid-Trip Handle, one per pole
 T Mid-Trip Handle, one per pole & Alarm Switch

3. POLES ²

1 One 2 Two 3 Three ³

4. CIRCUIT

B Series Trip (Current)

5 AUXILIARY/ALARM SWITCH ⁴

0 without Aux Switch
 2 S.P.D.T., 0.110 Q.C. Term.
 3 S.P.D.T., 0.110 Solder Lug
 8 S.P.S.T., 0.187 Q.C. Term.
 9 S.P.D.T., 0.187 Q.C. Term.

6 FREQUENCY & DELAY

21 AC Ultra Short	42 AC, Short, High-inrush
22 AC Short	44 AC, Medium, High-inrush
24 AC Medium	46 AC, Long, High-inrush
26 AC Long	

7. CURRENT RATING (AMPERES)

CODE	AMPERES							
210	0.100	285	0.850	455	5.500	613	13.000	
215	0.150	290	0.900	460	6.000	614	14.000	
220	0.200	295	0.950	465	6.500	615	15.000	
225	0.250	410	1.000	470	7.000	616	16.000	
230	0.300	512	1.250	475	7.500	617	17.000	
235	0.350	415	1.500	480	8.000	618	18.000	
240	0.400	517	1.750	485	8.500	620	20.000	
245	0.450	420	2.000	490	9.000	622	22.000	
250	0.500	522	2.250	495	9.500	624	24.000	
255	0.550	527	2.750	610	10.000	625	25.000	
260	0.600	430	3.000	710	10.500	630	30.000	
265	0.650	435	3.500	611	11.000			
270	0.700	440	4.000	711	11.500			
275	0.750	445	4.500	612	12.000			
280	0.800	450	5.000	712	12.500			

8. TERMINAL ⁴

1 Push-On 0.250 Tab (Q.C.)	A Load Terminal #8 Screw (Q.C.)
2 Screw 8-32 with upturned lugs	B Combination (Special Catalog #)
3 Screw 8-32 (Bus Type)	F Screw M5 with upturned lugs
4 Screw 10-32 with upturned lugs	G Screw M5 (Bus Type) & 30° bend
5 Screw 10-32 (Bus Type)	H Screw M5 (Bus Type)
6 Screw 8-32 with upturned lugs & 30° bend	J Screw M5 Back Connect
7 Screw 8-32 (Bus Type) & 30° bend	K Screw 10-32 Back Connect
8 Screw 10-32 with upturned lugs & 30° bend	M M6 Threaded Stud
9 Screw 10-32 (Bus Type) & 30° bend	N Screw M4 Back Connect & 30° bend
	Q Push-In Stud
	Y Screw 8-32 Back Connect

9 ACTUATOR COLOR & LEGEND

Actuator Color	ON-OFF	Dual	Legend Color
White	B	1	Black
Black	D	2	White
Red	G	3	White
Green	J	4	White
Blue	L	5	White
Yellow	N	6	Black
Gray	Q	7	Black
Orange	S	8	Black

10. MOUNTING / BARRIERS ⁹

	MOUNTING STYLE	BARRIERS
	Threaded Insert, 2 per pole	
A	6-32 x 0.195 inches	yes
B	ISO M3 x 5mm	yes
	Rectangular Adapter Plate with mounting centers of 2.062 inches [52.37mm] and Threaded insert, 2 per pole	
C	6-32 x 0.225 inches	yes
D	ISO M3 x 6.5mm	yes
	Front panel Snap-In, 0.75" [19.05mm] wide bezel	
6	without Handguard	yes
	Front panel Snap-In, 0.96" wide bezel	
8	without Handguard	yes
	.105" bezel overhang on all sides, for multi-pole units	

11. MAXIMUM APPLICATION RATING

C ⁸ 120/240VAC
 K 120VAC

12. AGENCY APPROVAL

G UL489 Listed
 3 UL489 Listed, TUV Certified

Notes:

- Actuator Code:
 A: Handle tie pin spacer(s) and retainers provided un-assembled with multi-pole units.
 B: Handle location as viewed from front of breaker:
 2 pole - left pole 3 pole - center pole
 S: Handle moves to mid-position only upon electrical trip of the breaker. Available with circuit codes B, C, D, E, F, G, H and K.
 T: Handle moves to mid-position and alarm switch activates only upon electrical trip of the breaker. Available with circuit codes B & C.
- All poles must be same polarity.
- 3 pole units available only when 1 of 3 poles is neutral.
- Auxiliary/Alarm Switch circuit must be same polarity as the main circuit. On multi-pole breakers, one auxiliary switch is supplied, mounted in the extreme right pole.
- Screw Terminals are recommended on ratings greater than 20 amps.
- Standard actuator colors are black and white.
- Adapter plate with mounting centers of 2.082 inches. Available with Actuator Codes A, S and T.
- Voltage Rating available with 2 and 3-pole breakers only.
- Barriers supplied on multi-pole units only.

[Configure Complete Part Number >](#)

[Browse Standard Parts >](#)

Circuit & Terminal Diagrams Handle

inches [millimeters]

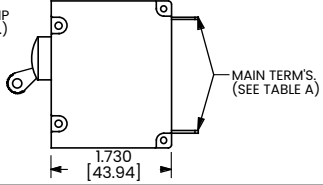
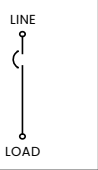
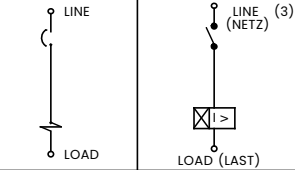
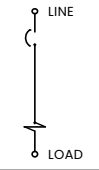
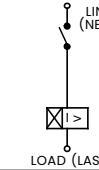
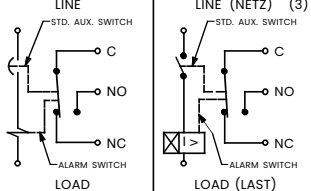
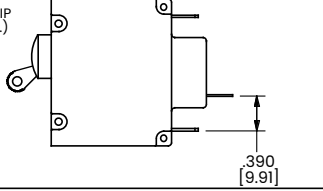
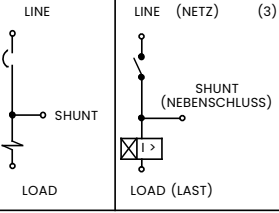
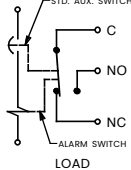
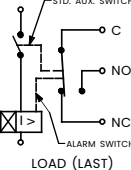
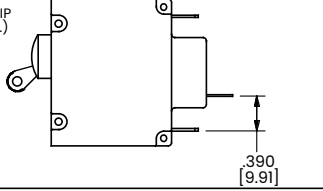
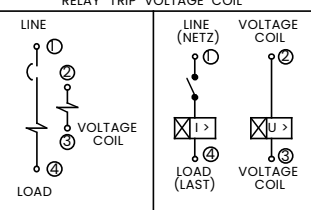
	CIRCUIT SCHEMATIC		CIRCUIT CODE	AUX SWITCH CODE	CIRCUIT SCHEMATIC		CIRCUIT CODE	AUX SWITCH CODE
	ANSI	IEC			ANSI	IEC		
SERIES TRIP (2 TERM'S.) 	SWITCH ONLY (NO COIL) 		A	O	SERIES TRIP 		B C	O
SERIES TRIP W/ AUX SWITCH (5 TERM'S.) 	SWITCH ONLY (NO COIL) WITH AUXILIARY SWITCH 		A	2 3 4	SERIES TRIP WITH AUXILIARY / ALARM SWITCH 		B C	2 3 4
SHUNT TRIP (3 TERM'S.) 	SHUNT TRIP 		D E	0	DUAL COIL; SERIES TRIP CURRENT COIL, SHUNT TRIP VOLTAGE COIL 		H	0
RELAY TRIP (4 TERM'S.) 	RELAY TRIP 		F G	0	DUAL COIL; SERIES TRIP CURRENT COIL, RELAY TRIP VOLTAGE COIL 		K	0

CIRCUIT BREAKER MODE	STANDARD C/B		MID TRIP C/B		MID TRIP C/B	
	HANDLE POSITION	AUX. SWITCH MODE	HANDLE POSITION	ALARM SWITCH MODE	HANDLE POSITION	AUX. SWITCH MODE (w/ALARM SWITCH)
OFF						
ON						
ELECTRICAL TRIP						

Notes:
 1 Tolerance ±.020 [.51] unless otherwise specified.
 2 Alarm Switch available with .110 x .020 Q.C. & Solder Lug Terminals Only.

Circuit & Terminal Diagrams Handle

inches [millimeters]

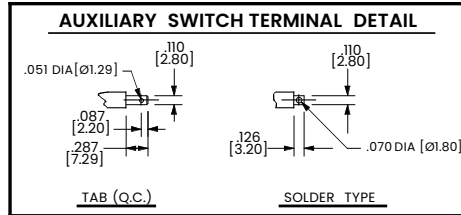
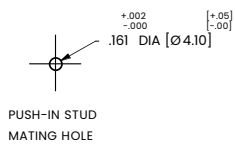
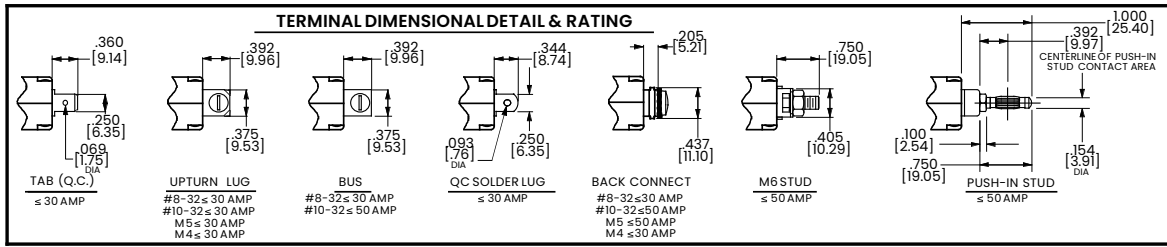

**TABLE A
TIGHTENING TORQUE SPECIFICATIONS**

THREAD SIZE	TORQUE
#6-32 & M3 MOUNTING HARDWARE	7-9 IN-LBS [0.8-1.0 NM]
#8-32 & M4 THREAD TERMINAL SCREW	12-15 IN-LBS [1.4-1.7 NM]
#10-32 & M5 THREAD TERMINAL SCREW	15-20 IN-LBS [1.7-2.3 NM]

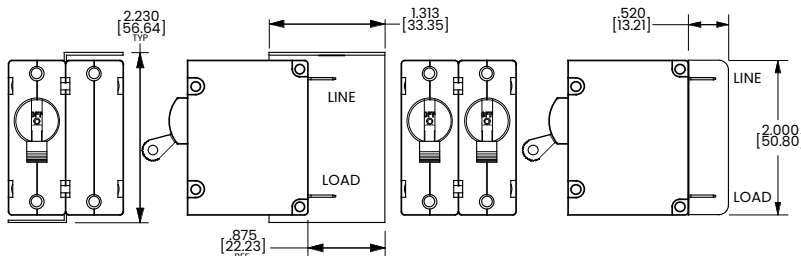
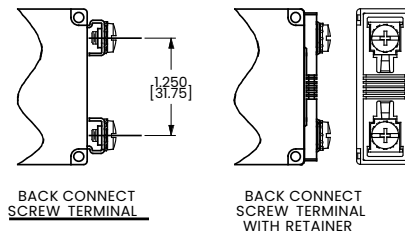
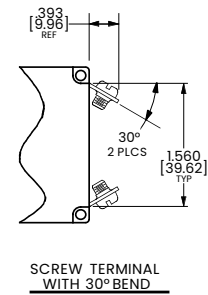
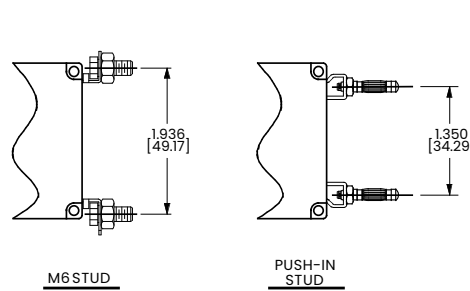
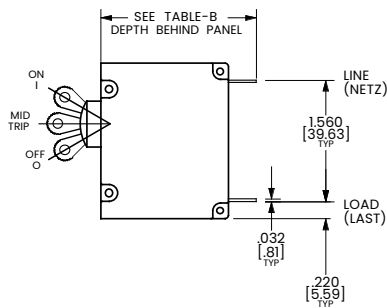

TABLE B

TERMINAL DESCRIPTION		DEPTH BEHIND PANEL
MAIN	TAB (Q.C.)	2.090 [53.09]
	SCREW TYPE	2.122 [53.90]
SHUNT, RELAY & DUAL COIL	TAB (Q.C.)	2.612 [66.35]
	SCREW #8-32 W/UPTURNED LUGS	2.644 [67.16]
	TAB (Q.C.) .110 x .020	2.537 [64.44]
AUX. SWITCH*	SOLDER TYPE	2.348 [59.64]

* AVAILABLE ON SERIES TRIP AND SWITCH ONLY CIRCUITS. WHEN CALLED FOR ON MULTI-POLE UNITS, ONLY ONE AUX. SWITCH IS NORMALLY SUPPLIED, AS SHOWN IN MULTI-POLE IDENTIFICATION SCHEME.



Notes:
1 Tolerance ±.020 [.51] unless otherwise specified.

Dimensional Specs Handle

inches [millimeters]

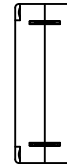
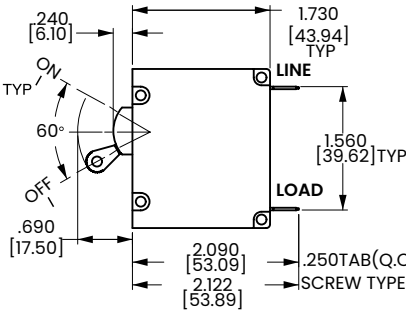
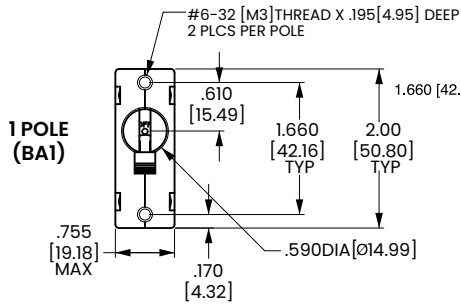

TAB (Q.C.) TYPE TERMINALS IN SERIES TRIP CIRCUIT CONFIGURATION SHOWN. FOR OTHER CONFIGURATIONS, SEE CIRCUIT AND TERMINAL DIAGRAMS.

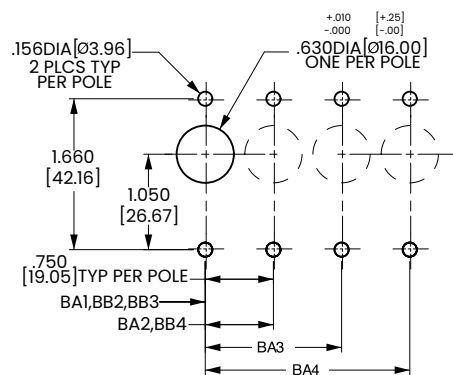
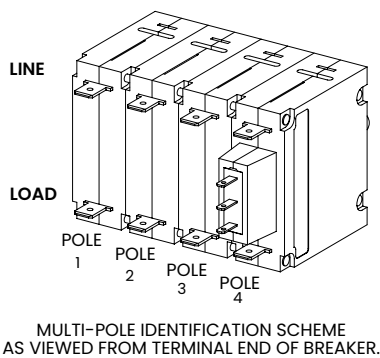
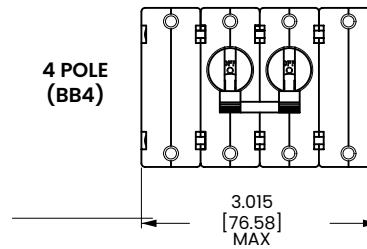
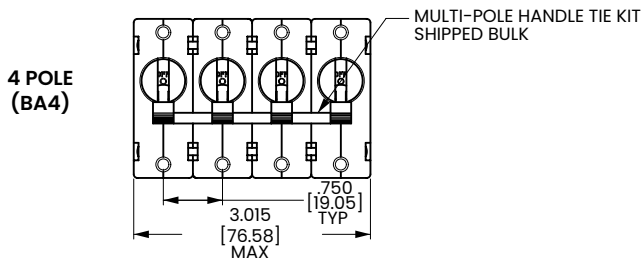
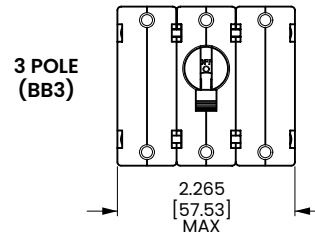
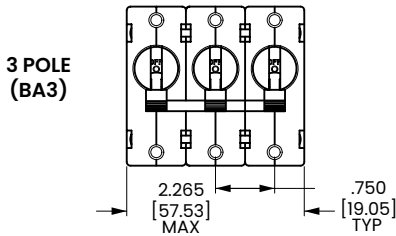
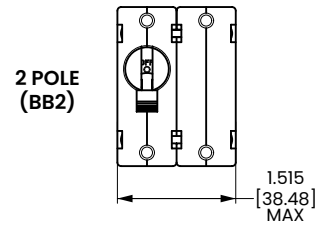
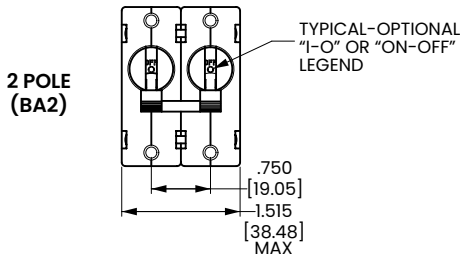

PANEL CUTOUT DETAIL

TOLERANCES ±.005 [±.12]

Notes:
1 Tolerance ± 0.20 [.5] unless otherwise specified.

Dimensional Specs Handle

inches [millimeters]

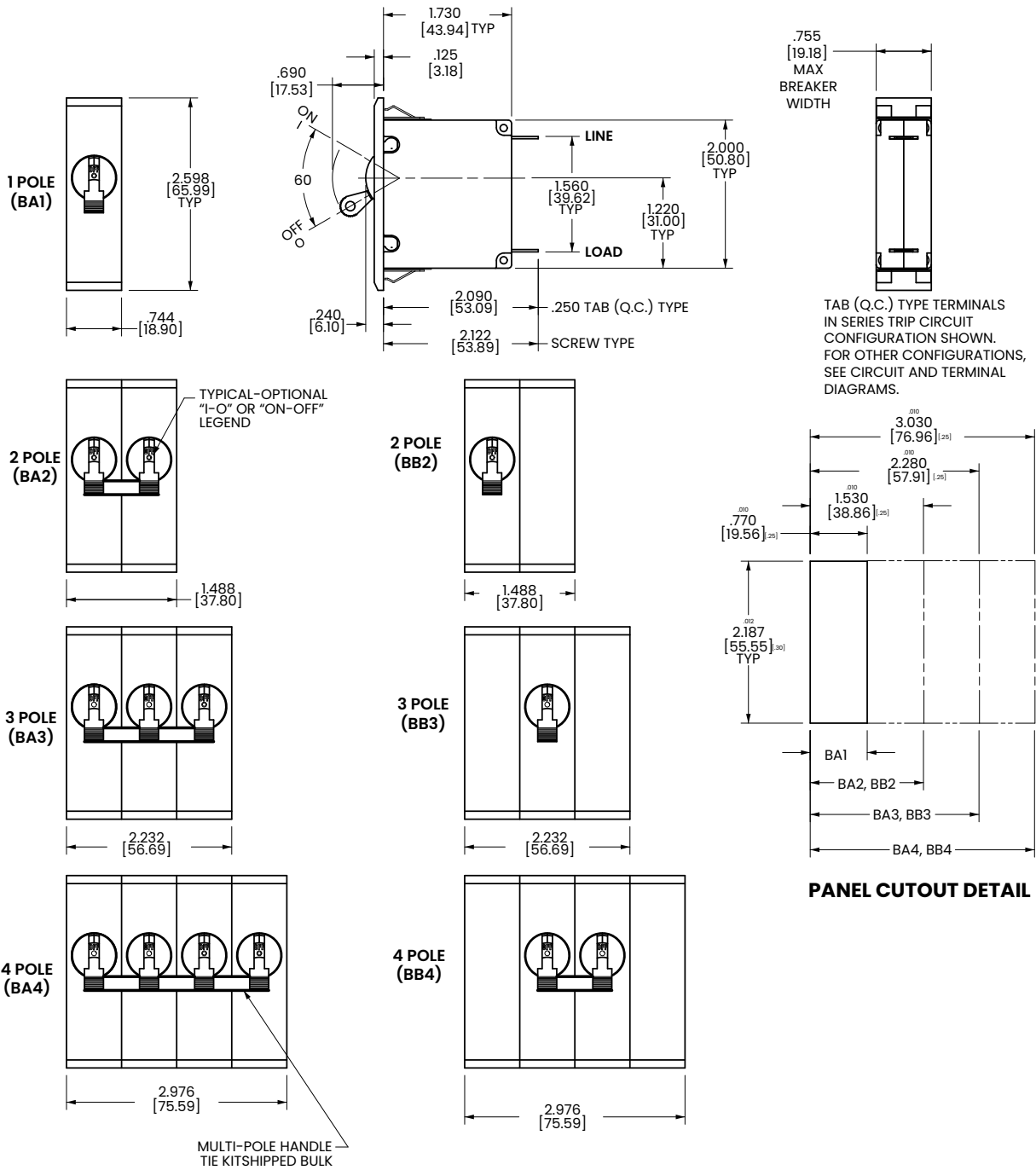

- Notes:
- 1 Recommended panel thickness: .040 [1.02] to .100 [2.54].
 - 2 Tolerance ±.020 [.51] unless otherwise specified.

Dimensional Specs Handle

inches [millimeters]

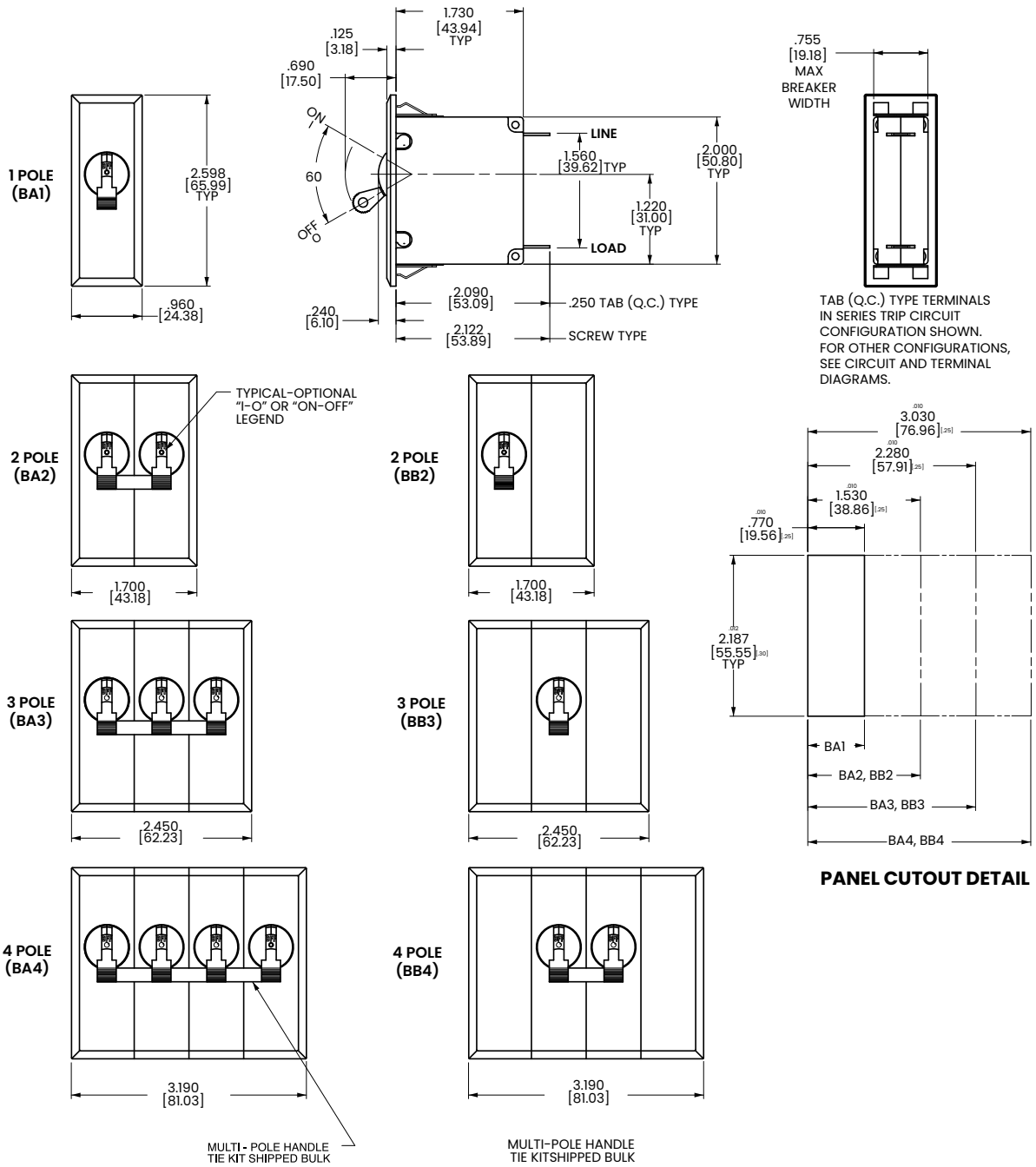

Notes:
 1 Recommended panel thickness: .040 [1.02] to .100 [2.54].
 2 Tolerance ±.020 [.51] unless otherwise specified.

Ordering Scheme Rocker - UL 489 Listed

Sample Part Number

B F 1 - B 0 - 24 - 630 - 2 3 A - K G

Selection 1 2 3 4 5 6 7 8 9 10 11 12

1. SERIES

B

2. ACTUATOR ¹

Two Color Visi-Rocker

- C** Indicate ON, vertical legend
- D** Indicate ON, horizontal legend
- F** Indicate OFF, vertical legend
- G** Indicate OFF, horizontal legend

Single color

- J** Vertical legend
- K** Horizontal legend

ROCKER STYLE DESCRIPTIONS

	INDICATE "ON"	INDICATE "OFF"	SINGLE COLOR
VERTICAL STYLE	CODE "C" 	CODE "F" 	CODE "J"
	CODE "D" 	CODE "G" 	CODE "K"
HORIZONTAL STYLE			

3. POLES ^{1,2}

1 One **2** Two **3** Three ³

4. CIRCUIT

B Series Trip (Current)

5 AUXILIARY/ALARM SWITCH ⁴

- | | |
|-------------------------------------|---|
| 0 without Aux Switch | 7 S.P.S.T., 0.110 Q.C. Term. (Gold Contacts) |
| 1 S.P.D.T., 0.093 Q.C. Term. | 8 S.P.S.T., 0.187 Q.C. Term. |
| 2 S.P.D.T., 0.110 Q.C. Term. | 9 S.P.D.T., 0.187 Q.C. Term. |
| 3 S.P.D.T., 0.110 Solder Lug | |

6. FREQUENCY & DELAY

- | | |
|--------------------------|-----------------------------------|
| 21 AC Ultra Short | 42 AC, Short, High-inrush |
| 22 AC Short | 44 AC, Medium, High-inrush |
| 24 AC Medium | 46 AC, Long, High-inrush |
| 26 AC Long | |

7. CURRENT RATING (AMPERES)

CODE	AMPERES						
210	0.100	285	0.850	455	5.500	613	13.000
215	0.150	290	0.900	460	6.000	614	14.000
220	0.200	295	0.950	465	6.500	615	15.000
225	0.250	410	1.000	470	7.000	616	16.000
230	0.300	512	1.250	475	7.500	617	17.000
235	0.350	415	1.500	480	8.000	618	18.000
240	0.400	517	1.750	485	8.500	620	20.000
245	0.450	420	2.000	490	9.000	622	22.000
250	0.500	522	2.250	495	9.500	624	24.000
255	0.550	527	2.750	610	10.000	625	25.000
260	0.600	430	3.000	710	10.500	630	30.000
265	0.650	435	3.500	611	11.000		
270	0.700	440	4.000	711	11.500		
275	0.750	445	4.500	612	12.000		
280	0.800	450	5.000	712	12.500		

8. TERMINAL ⁵

- | | |
|--|---|
| 1 ⁶ Push-On 0.250 Tab (Q.C.) | 9 Screw 10-32 (Bus Type) & 30° bend |
| 2 Screw 8-32 with upturned lugs | B Screw M5 with upturned lugs |
| 3 Screw 8-32 (Bus Type) | C Screw M4 with upturned lugs |
| 4 Screw 10-32 with upturned lugs | F Screw M5 with upturned lugs & 30° bend |
| 5 Screw 10-32 (Bus Type) | G Screw M5 (Bus Type) & 30° bend |
| 6 Screw 8-32 with upturned lugs & 30° bend | H Screw M5 (Bus Type) |
| 7 Screw 8-32 (Bus Type) & 30° bend | J Screw M5 Back Connect |
| 8 Screw 10-32 with upturned lugs & 30° bend | K Screw 10-32 Back Connect |
| | N Screw M4 Back Connect & 30° bend |
| | Y Screw 8-32 Back Connect |

9 ACTUATOR COLOR & LEGEND

Actuator or Visi-Color ⁷	Marking:	Marking Color
White B	ON-OFF 1 Black	Dual ⁷ White
Black D	2 White	n/a
Red G	3 White	Red
Green J	4 White	Green
Blue L	5 White	Blue
Yellow N	6 Black	Yellow
Gray Q	7 Black	Gray
Orange S	8 Black	Orange

10. MOUNTING / BARRIERS

	MOUNTING STYLE	BARRIERS ⁹
A	Threaded Insert, 2 per pole	
B	6-32 x 0.195 inches (multipole units only)	yes
	ISO M3 x 5mm	yes
C	ROCKERGUARD BEZEL	
	Threaded Insert, 2 per pole	
D	6-32 X 0.225 inches (multipole units only)	yes
	ISO M3 x 6.5mm	yes

11. MAXIMUM APPLICATION RATING

- C** ⁸ 120/240VAC
- K** 120VAC

12. AGENCY APPROVAL

- G** UL489 Listed
- 3** UL489 Listed, TUV Certified

Notes:

- 1 Multi-pole breakers have all breakers identical except when specifying Auxiliary switch and/or mixed poles, and have one rocker per breaker.
- 2 All poles must be same polarity.
- 3 3 pole units available only when 1 of 3 poles is neutral.
- 4 On multi-pole breakers, one auxiliary switch is supplied, mounted in the extreme right pole.
- 5 Screw Terminals are recommended on ratings greater than 20 amps.
- 6 Terminal Code 1 (Push-On) available up to 30 amps, but are not recommended over 20 amps.
- 7 Dual legend = ON-OFF/I-O
- 8 Voltage Rating available with 2 and 3-pole breakers only.
- 9 Barriers supplied on multi-pole units only.

[Configure Complete Part Number >](#)

[Browse Standard Parts >](#)

Ordering Scheme Flat Rocker - UL 489 Listed

Sample Part Number

B 1 1 - B 0 - 24 - 630 - 2 3 A - K G

Selection 1 2 3 4 5 6 7 8 9 10 11 12

1. SERIES

B

2. ACTUATOR 1

Two Color Visi-Rocker
1 Indicate OFF, vertical legend
2 Indicate OFF, horizontal legend
Single color
3 Vertical legend
4 Horizontal legend

Push-To-Reset, Visi-Rocker
5 Indicate OFF, vertical legend
6 Indicate OFF, horizontal legend
Push-To-Reset, Single color
7 Vertical legend
8 Horizontal legend

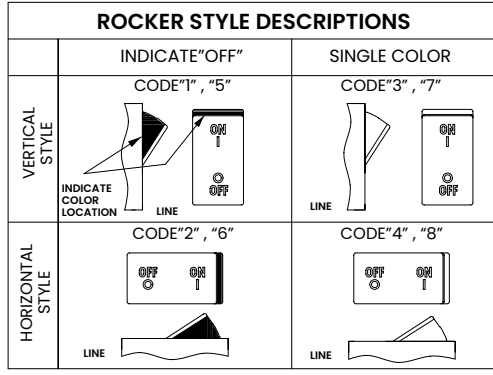

3. POLES 1,2

1 One **2** Two **3** Three ⁴

4. CIRCUIT

B Series Trip (Current)

5 AUXILIARY/ALARM SWITCH 4

0 without Aux Switch	7 S.P.D.T., 0.110 Q.C. Term. (Gold Contacts)
1 S.P.D.T., 0.093 Q.C. Term.	8 S.P.D.T., 0.187 Q.C. Term.
2 S.P.D.T., 0.110 Q.C. Term.	9 S.P.D.T., 0.187 Q.C. Term.
3 S.P.D.T., 0.110 Solder Lug	

6. FREQUENCY & DELAY

21 AC Ultra Short	42 AC, Short, High-inrush
22 AC Short	44 AC, Medium, High-inrush
24 AC Medium	46 AC, Long, High-inrush
26 AC Long	

7. CURRENT RATING (AMPERES)

CODE	AMPERES	
210	0.100	285 0.850
215	0.150	290 0.900
220	0.200	295 0.950
225	0.250	410 1.000
230	0.300	512 1.250
235	0.350	415 1.500
240	0.400	517 1.750
245	0.450	420 2.000
250	0.500	522 2.250
255	0.550	527 2.750
260	0.600	430 3.000
265	0.650	435 3.500
270	0.700	440 4.000
275	0.750	445 4.500
280	0.800	450 5.000
		455 5.500
		460 6.000
		465 6.500
		470 7.000
		475 7.500
		480 8.000
		485 8.500
		490 9.000
		495 9.500
		610 10.000
		710 10.500
		611 11.000
		711 11.500
		612 12.000
		712 12.500
		613 13.000
		614 14.000
		615 15.000
		616 16.000
		617 17.000
		618 18.000
		620 20.000
		622 22.000
		624 24.000
		625 25.000
		630 30.000

8. TERMINAL 6

1 Push-On 0.250 Tab (Q.C.)	9 Screw 10-32 (Bus Type) & 30° bend
2 Screw 8-32 with upturned lugs	B Screw M5 with upturned lugs
3 Screw 8-32 (Bus Type)	C Screw, M4 with upturned lugs
4 Screw 10-32 with upturned lugs	F Screw M5 with upturned lugs & 30° bend
5 Screw 10-32 (Bus Type)	G Screw M5 (Bus Type) & 30° bend
6 Screw 8-32 with upturned lugs & 30° bend	H Screw M5 (Bus Type)
7 Screw 8-32 (Bus Type) & 30° bend	J Screw M5 Back Connect
8 Screw 10-32 with upturned lugs & 30° bend	K Screw 10-32 Back Connect
	N Screw M4 Back Connect & 30° bend
	Y Screw 8-32 Back Connect

9 ACTUATOR COLOR & LEGEND

Actuator or Visi-Color ⁸	Marking:		Marking Color	
	ON-OFF	Dual ⁷	Single Color	Visi-Rocker
White	B	1	Black	White
Black	D	2	White	n/a
Red	G	3	White	Red
Green	J	4	White	Green
Blue	L	5	White	Blue
Yellow	N	6	Black	Yellow
Gray	Q	7	Black	Gray
Orange	S	8	Black	Orange

10. MOUNTING / BARRIERS

	STANDARD ROCKER BEZEL Threaded Insert, 2 per pole FLAT ROCKER ACTUATOR	BARRIERS ¹²
A	6-32 x 0.195 inches (multi-pole units only)	yes
B	ISO M3 x 5mm	yes
	RECESSED OFF SIDE ROCKER ACTUATOR ¹⁰	
E	6-32 X 0.225 inches (multi-pole units only)	yes
F	ISO M3 x 6.5mm	yes
	PUSH-TO-RESET BEZEL, Threaded Insert, 2 per pole	
C	6-32 x 0.195 inches	yes
D	ISO M3 x 5mm	yes

11. MAXIMUM APPLICATION RATING

C 120/240VAC ¹¹
K 120VAC

12. AGENCY APPROVAL

G UL489 Listed
3 UL489 Listed, TUV Certified

Notes:

- Push-To-Reset actuators have OFF portion of rocker shrouded.
- Multi-pole breakers have all breakers identical except when specifying Auxiliary switch and/or mixed poles, and have one rocker per breaker.
- All poles must be same polarity.
- 3 pole units available only when 1 of 3 poles is neutral.
- On multi-pole breakers, one auxiliary switch is supplied, mounted in the extreme right pole.
- Screw Terminals are recommended on ratings greater than 20 amps.
- Terminal Code 1 (Push-On) available up to 30 amps, but are not recommended over 20 amps.
- Color shown is visi and legend with remainder of rocker black, Dual = ON-OFF/I-O legend.
- Legend on Push-to-reset bezel/shroud is white with single color actuator codes 7 & 8. Legend on Push-To-Reset bezel/shroud matches Visi-Color of rocker with actuator codes 5 & 6.
- Recessed "off-side" available with actuator codes 1, 2, 3 & 4. Legends on rocker are available in ink stamping only.
- Voltage rating available with 2 & 3-pole breakers only.
- Barriers supplied on multi-pole units only.

[Configure Complete Part Number >](#)

[Browse Standard Parts >](#)

Dimensional Specs

Flat Rocker UL489 Listed

inches [millimeters]

INDICATE "OFF" & SINGLE COLOR
(INDICATE "OFF" SHOWN)

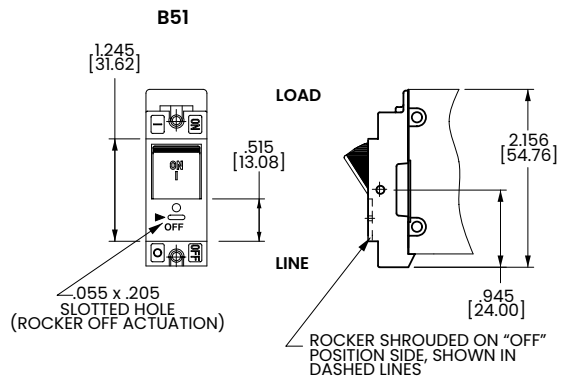
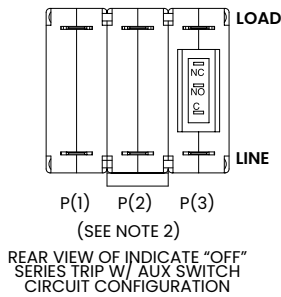
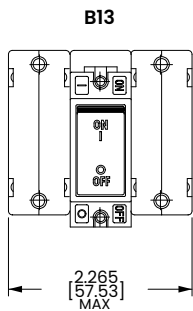
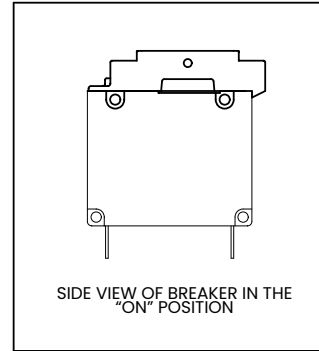
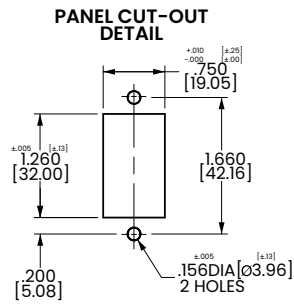
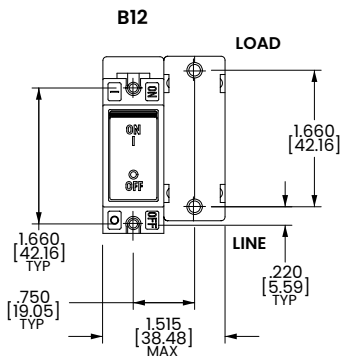
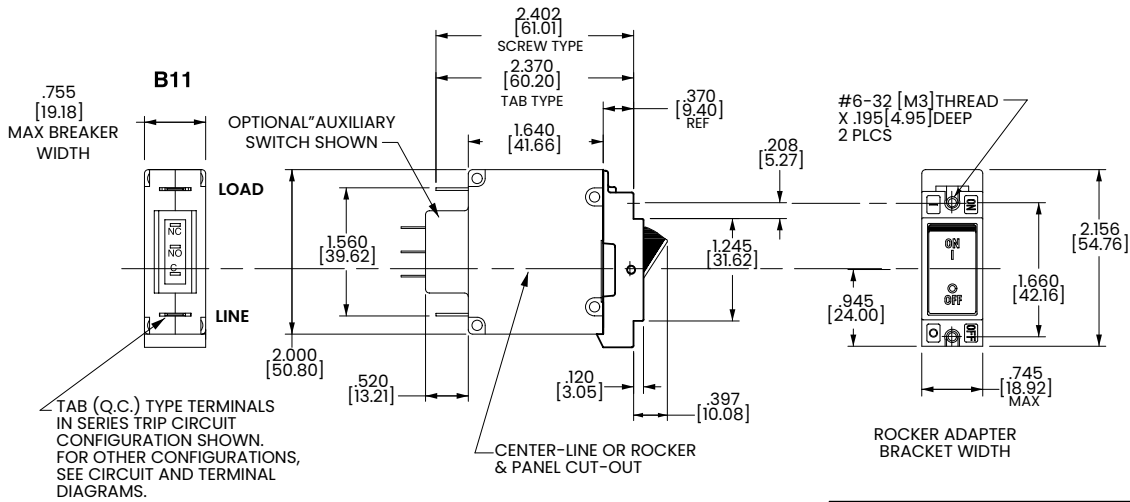

PUSH-TO-RESET ACTUATOR

ACTUATOR SIDE VIEW (SURFACE CONTOURS)

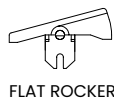

- Notes:
- 1 For pole orientation with horizontal legend, rotate front view clockwise 90°.
 - 2 Tolerance ±.010 [±.25] unless otherwise specified.

PC Terminal Diagrams

inches [millimeters]

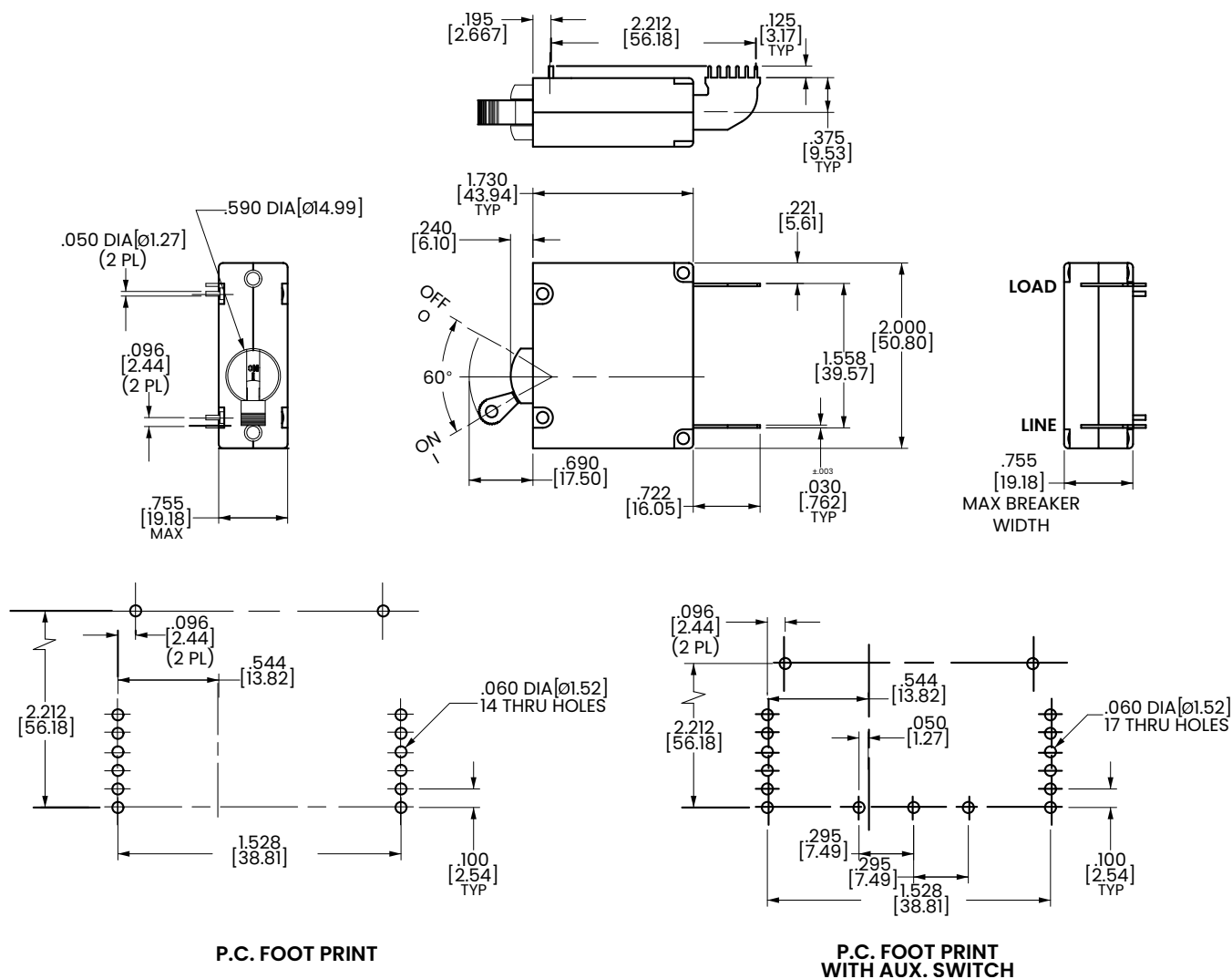

Notes:

- 1 For pole orientation with horizontal legend, rotate front view clockwise 90°.
- 2 Tolerance ±.010 [.25] unless otherwise specified.

Authorized Sales Representatives and Distributors

Click on a region of the map below to find your local representatives and distributors or visit www.carlingtech.com/findarep.



About Carling

Founded in 1920, Carling Technologies is a leading manufacturer of electrical and electronic switches and assemblies, circuit breakers, electronic controls, power distribution units, and multiplexed power distribution systems. With six ISO9001 and IATF16949 registered manufacturing facilities and technical sales offices worldwide, Carling Technologies Sales, Service and Engineering teams do much more than manufacture electrical components, they engineer powerful solutions! To learn more about Carling please visit www.carlingtech.com/company-profile.

To view all of Carling's environmental, quality, health & safety certifications please visit www.carlingtech.com/environmental-certifications.

X-ON Electronics

Largest Supplier of Electrical and Electronic Components

Click to view similar products for [Circuit Breakers](#) category:

Click to view products by [Carling](#) manufacturer:

Other Similar products are found below :

[0185080.X](#) [0185100.XP](#) [0185150.XP](#) [0700005](#) [0700007](#) [0700010](#) [0700015](#) [0700020](#) [0700025](#) [0700030](#) [0700040](#) [0712107](#) [0712123](#)
[0712152](#) [0712194](#) [0712217](#) [0712233](#) [0712259](#) [0712275](#) [0712291](#) [0712314](#) [0900100](#) [0900113](#) [0900126](#) [0900207](#) [0900210](#) [0900317](#)
[0900333](#) [0900414](#) [0900618](#) [0900634](#) [0900812](#) [0901002](#) [0902030](#) [0902056](#) [0902072](#) [0902098](#) [0902108](#) [0902111](#) [0902124](#) [0902137](#)
[0902218](#) [0902221](#) [0902247](#) [0902263](#) [0902328](#) [0902331](#) [0902344](#) [0902409](#) [0902412](#)