

CLB-Series

Thermal Circuit Breaker

[PRODUCT WEBPAGE](#)

request sample, configure part

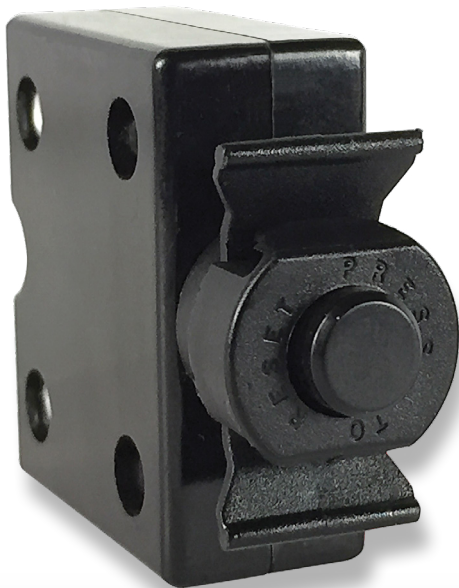
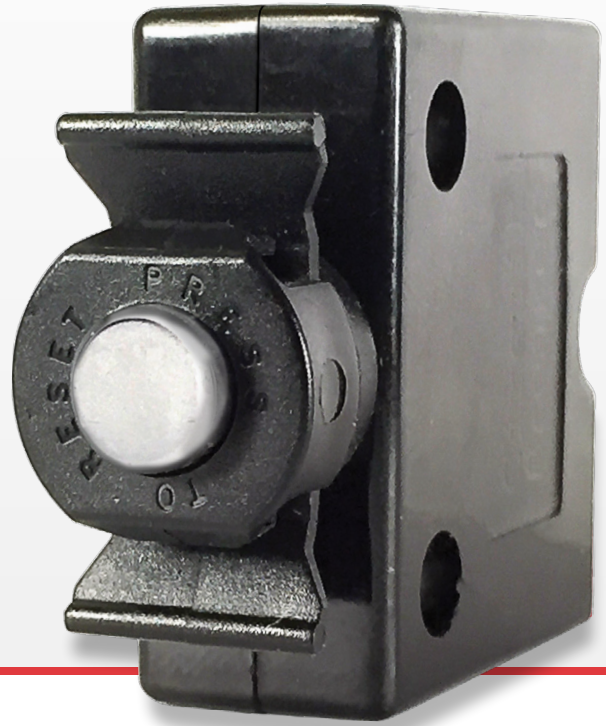

Push-to-Reset

Part of Carling's push-to reset family of thermal circuit breakers, the CLB-Series is designed with minimal moving parts, to assure cost-effective but reliable protection for a wide range of equipment applications. Offering a consistent trip point over temperatures ranging from -10°C to +60°C, this single pole breaker is rated from 3-60 amps, 125/250VAC, 32VDC with 1,000 AIC at 250VAC and 2,500 AIC at 32VDC.

1

Pole

3-60

Amps

125-250

VAC Max

32

VDC Max

Typical Applications

- Household Appliances
- On/Off-Highway
- Medical Equipment
- Power Strips & Supplies
- Marine
- Audio-Visual Equipment

Ordering Scheme

Sample Part Number **CLB - 10 3 - 12 C 3 N - B - A / 10**

Selection 1 2 3 4 5 6 7 8 9 10

1. SERIES

CLB

2. RATING

03	3 amps	10	10 amps	25	25 amps
04	4 amps	12	12 amps	30	30 amps
05	5 amps	13	13 amps	35	35 amps
06	6 amps	15	15 amps	40	40 amps
07	7 amps	18	18 amps	50	50 amps ¹²
08	8 amps	20	20 amps	60	60 amps ¹²

3. VOLTAGE

3 125-250VAC / 32 VDC

4. MOUNTING HOLE ^{see next page for diagram}

11	M11 ¹
12	M12 ²
00	Snap In Style ³
27	3/8" 27 UNS ⁴

5. BUSHING ^{see next page for diagram}

METAL		PLASTIC	
A	Type A ⁶	C	Type C ⁵
B	Type B ¹⁶	D	Type D ⁷
J	Type J ⁸	E	Type E ⁸

6. MOUNTING NUT ^{9 see next page for diagram}

N	None	5	Type 5
1	Type 1	6	Type 6 ^{4,14}
2	Type 2	7	Type 7 ⁴
3	Type 3 ¹⁷	8	Type 8 ⁴
4	Type 4		

7. INDICATOR PLATE ^{9 see next page for diagram}

N	None	B	Silver Printing on Black
A	Embossed Legend		

8. BUTTON

B	Black	R	Red	W	White
---	-------	---	-----	---	-------

9. TERMINAL ^{10,11,15 see next page for diagram}

A	Type A	E	Type E	J	Type J
B	Type B	F	Type F	K	Type K
C	Type C	G	Type G	R	Type R
D	Type D	H	Type H		

10. BUTTON MARKING (IF BLANK, NO MARKING) ¹³

Button Marking Orientation:

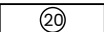
line  load

03	3 amp	10	10 amp	25	25 amp
04	4 amp	12	12 amp	30	30 amp
05	5 amp	13	13 amp	35	35 amp
06	6 amp	15	15 amp	40	40 amp
07	7 amp	18	18 amp	50	50 amp
08	8 amp	20	20 amp	60	60 amp

Notes: Tolerance ±.005 [127] unless otherwise specified.

- 1 Used with bushing A or B only.
- 2 Used with bushing A or C only.
- 3 Used with bushing D only.
- 4 Used with bushing E & J only.
- 5 Used with M12 mounting hole only.
- 6 Used with M11 and M12 mounting hole only.
- 7 Used with mounting hole 00 only.
- 8 Used with 27 mounting hole only.
- 9 All hardware available separately.
- 10 Greater than 35 amp rating must use solder joint to connect wire to non-screw type terminals.
- 11 Terminals are .040 [1.0] thickness for ratings greater than 35 amps. Terminals are .315 [0.8] thickness for ratings less than 35 amps.
- 12 Available only with 10-24 unc. screw terms. (select type F, G, H, J only.) UL, CUL only.
- 13 Amp rating must match button marking (ex: "20" will be marked on the button of the breaker) Thickness is 3.0 mm, .118 in.
- 14 Thickness is 3.0 mm, .118 in.
- 15 Screw terminals are 8-32 UNC.
- 16 Used with M11 mounting hole only.
- 17 Includes molded in "PRESS TO RESET" marking.

[Configure Complete Part Number >](#)



[Browse Standard Parts >](#)

Ordering Scheme Diagrams

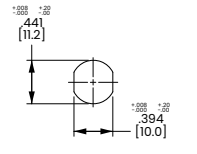
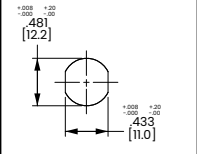
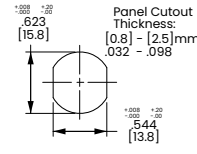
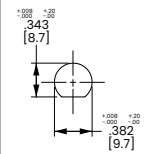
4. MOUNTING HOLE

 <p> $\begin{matrix} +.008 & -.002 \\ .441 \\ [11.2] \end{matrix}$ $\begin{matrix} +.008 & -.002 \\ .394 \\ [10.0] \end{matrix}$ </p>	 <p> $\begin{matrix} +.008 & -.002 \\ .481 \\ [12.2] \end{matrix}$ $\begin{matrix} +.008 & -.002 \\ .433 \\ [11.0] \end{matrix}$ </p>	 <p> Panel Cutout Thickness: $[0.8] - [2.5] \text{mm}$ $.032 - .098$ </p> <p> $\begin{matrix} +.008 & -.002 \\ .623 \\ [15.8] \end{matrix}$ $\begin{matrix} +.008 & -.002 \\ .544 \\ [13.8] \end{matrix}$ </p>	 <p> $\begin{matrix} +.008 & -.002 \\ .343 \\ [8.7] \end{matrix}$ $\begin{matrix} +.008 & -.002 \\ .382 \\ [9.7] \end{matrix}$ </p>
11	12	00	27

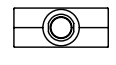
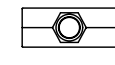
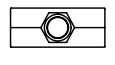
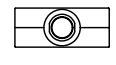
5. BUSHING

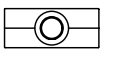
METAL			PLASTIC		
					
$\begin{matrix} .496 \\ [12.6] \end{matrix}$ $\begin{matrix} .158 \\ [4.0] \end{matrix}$	$\begin{matrix} .496 \\ [12.6] \end{matrix}$ $\begin{matrix} .049 \\ [1.25] \end{matrix}$	$\begin{matrix} .531 \\ [13.5] \end{matrix}$ $\begin{matrix} .059 \\ [1.5] \end{matrix}$	$\begin{matrix} .496 \\ [12.6] \end{matrix}$ $\begin{matrix} .158 \\ [4.0] \end{matrix}$	$\begin{matrix} .118 \\ [3.0] \end{matrix}$ $\begin{matrix} .433 \\ [11.0] \end{matrix}$	$\begin{matrix} .535 \\ [13.6] \end{matrix}$ $\begin{matrix} .063 \\ [1.60] \end{matrix}$
TYPE A	TYPE B	TYPE J	TYPE C	TYPE D	TYPE E

6. MOUNTING NUT

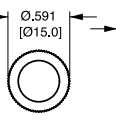
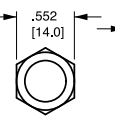
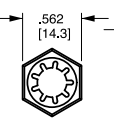
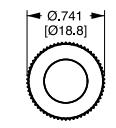
METAL	METAL PAL	PLASTIC	HEX BOOT
			
$\begin{matrix} \text{Ø} .591 \\ [Ø15.0] \end{matrix}$ $\begin{matrix} .099 \\ [2.5] \end{matrix}$	$\begin{matrix} .552 \\ [14.0] \end{matrix}$ $\begin{matrix} .110 \\ [2.8] \end{matrix}$	$\begin{matrix} .562 \\ [14.3] \end{matrix}$ $\begin{matrix} .094 \\ [2.4] \end{matrix}$	$\begin{matrix} \text{Ø} .741 \\ [Ø18.8] \end{matrix}$ $\begin{matrix} .118 \\ [3.0] \end{matrix}$
TYPE 1	TYPE 2 / TYPE 6	TYPE 3	TYPE 4
			TYPE 5 / TYPE 8

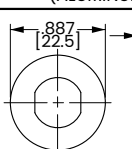
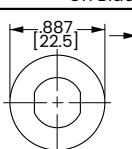

Type 5 is clear hex boot. Type 8 is black hex boot (available for bushings G, J & K only); Type 3 nut includes molded in "PRESS TO RESET" marking.

7. INDICATOR PLATE

Embossed (ALUMINUM)	Silver Printing On Black
	
$\begin{matrix} .887 \\ [22.5] \end{matrix}$ $\begin{matrix} .016 \\ [.4] \end{matrix}$	$\begin{matrix} .887 \\ [22.5] \end{matrix}$ $\begin{matrix} .016 \\ [.4] \end{matrix}$

All indicator plates are marked "Suppl. Prot. press to reset".

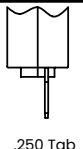
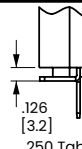
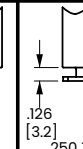
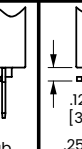
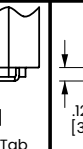
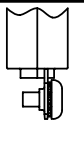
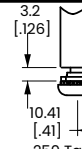
9. TERMINAL

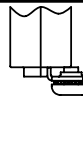
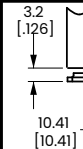
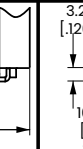
										
.250 Tab	$\begin{matrix} .126 \\ [3.2] \end{matrix}$.250 Tab	$\begin{matrix} .126 \\ [3.2] \end{matrix}$.250 Tab	$\begin{matrix} .126 \\ [3.2] \end{matrix}$.250 Tab	$\begin{matrix} .126 \\ [3.2] \end{matrix}$.250 Tab		$\begin{matrix} 3.2 \\ [.126] \end{matrix}$ $\begin{matrix} 10.41 \\ [41] \end{matrix}$.250 Tab	$\begin{matrix} 3.2 \\ [.126] \end{matrix}$ $\begin{matrix} 10.41 \\ [41] \end{matrix}$.250 Tab		$\begin{matrix} 3.2 \\ [.126] \end{matrix}$ $\begin{matrix} 10.41 \\ [10.41] \end{matrix}$.250 Tab	$\begin{matrix} 3.2 \\ [.126] \end{matrix}$ $\begin{matrix} 10.41 \\ [41] \end{matrix}$.250 Tab
TYPE A : Straight	TYPE B : Line Pin	TYPE C : Load Pin	TYPE D : 90° Bend	TYPE E : 90° Bend Backward	TYPE F : Screw Terminal	TYPE G : Mixed Terminals 90° Bend Line	TYPE H : Screw Terminal 90° Bend	TYPE J : Screw Terminal 90° Bend	TYPE R : Screw Terminal without	TYPE K : Mixed Terminals 90° Bend Load

Dimensional Specs

inches [millimeters]

3-40A Construction

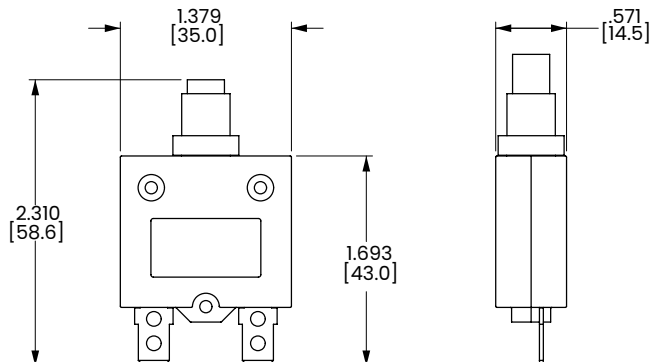

50 & 60A Construction

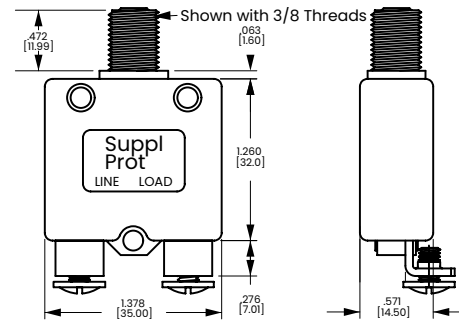

Time Delay

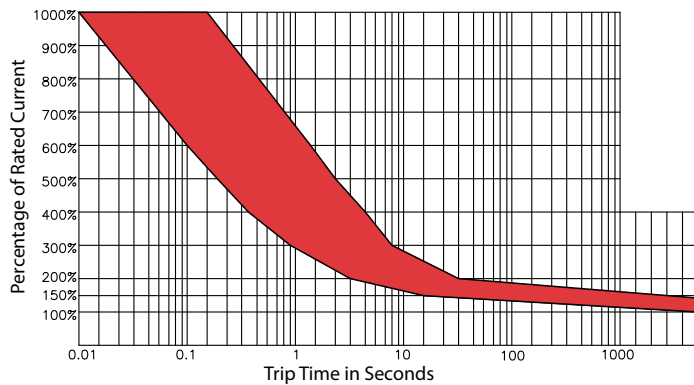

Overload	Trip Time
100%	No Trip
135%	Trip in 1 hr
200%	4.0 ~ 40 sec.
300%	0.9 ~ 8.0 sec.
400%	0.42 ~ 5.0 sec.
500%	0.25 ~ 3.0 sec.
600%	0.01 ~ 1.8 sec.

Trip Time Factor ¹	
-10 °C	x 1.70
-5 °C	x 1.60
0 °C	x 1.50
5 °C	x 1.40
10 °C	x 1.30
15 °C	x 1.20
20 °C	x 1.10
25 °C	x 1.00
30 °C	x 0.90
35 °C	x 0.85
40 °C	x 0.80
45 °C	x 0.75
50 °C	x 0.70
55 °C	x 0.65
60 °C	x 0.60

Notes:
1. Trip Time factor is a guideline that indicates ambient temperature effect on trip times at various overload values.

Authorized Sales Representatives and Distributors

Click on a region of the map below to find your local representatives and distributors or visit www.carlingtech.com/findarep.



About Carling

Founded in 1920, Carling Technologies is a leading manufacturer of electrical and electronic switches and assemblies, circuit breakers, electronic controls, power distribution units, and multiplexed power distribution systems. With six ISO9001 and IATF16949 registered manufacturing facilities and technical sales offices worldwide, Carling Technologies Sales, Service and Engineering teams do much more than manufacture electrical components, they engineer powerful solutions! To learn more about Carling please visit www.carlingtech.com/company-profile.

To view all of Carling's environmental, quality, health & safety certifications please visit www.carlingtech.com/environmental-certifications.

© Carling Technologies, Inc.

5. Carling is a registered trademark of Carling Technologies, Inc. in the U.S. and other countries.

X-ON Electronics

Largest Supplier of Electrical and Electronic Components

Click to view similar products for [Circuit Breakers](#) category:

Click to view products by [Carling](#) manufacturer:

Other Similar products are found below :

[LUGZX66-1-61-20.0-44](#) [M39019/01-201S](#) [M39019/01-221](#) [M39019/01-323](#) [M39019/01-333](#) [M39019/01-336](#) [M39019/02-248](#) [M39019/02-311](#) [M39019/02-316](#) [M39019/04-249S](#) [M39019/05-246S](#) [M39019/06-254S](#) [M55629/1-016](#) [M55629/1-018](#) [M55629/1-021](#) [M55629/1-033](#) [M55629/1-036](#) [M55629/1-046](#) [M55629/1-048](#) [M55629/1-058](#) [M55629/1-067](#) [M55629/1-070](#) [M55629/1-079](#) [M55629/1-084](#) [M55629/1-085](#) [M55629/1-101](#) [M55629/1-109](#) [M55629/11-102](#) [M55629/1-120](#) [M55629/12-045](#) [M55629/12-046](#) [M55629/1-330](#) [M55629/1-366](#) [M55629/1-387](#) [M55629/1-401](#) [M55629/1-450](#) [M55629/2-022](#) [M55629/2-030](#) [M55629/2-072](#) [M55629/2-082](#) [M55629/2-099](#) [M55629/2-101](#) [M55629/2-102](#) [M55629/21-BM-BM](#) [M55629/21-HM-HM](#) [M55629/21-NS-NS](#) [M55629/22-NR-NR-NR](#) [M55629/22-RS-RS-RS](#) [M55629/2-347](#) [M55629/2-401](#)