

RF Microwave Standard Assemblies



Q-Flex® Series Specifications

Q-Flex® assemblies are a unique ALTERNATIVE to custom designed flexible coaxial cables. Traditionally custom specified, these cables are now available in various lengths and deliverable in 24 hours.

There is less than .05dB insertion loss with flexure, so your requirements for a stable cable are easily maintained.

Q-Flex® utilizes Tensolite's anti-torque SMA, SMP or a connector of your choice, thus extending the cable's useful life.

Assembly Cable Code	Bulk Cable P/N	OD
461	LLF-1087	.105"
794	HFF-1087	.105"
463	LLF-1141	.163"
465	LLF-1250	.270"

Flexible Alternatives to RG 405, 402 and 401 with improved attenuation

18 GHz SMA Male to SMA Male on 461 Q-Flex® Cable

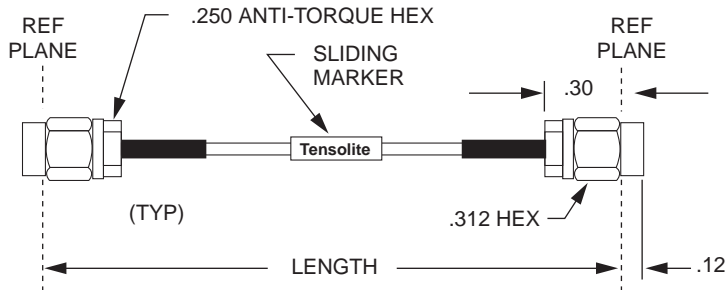

Tensolite Part Number	Length Inches	+ - Inches	Weight Ounces
1-3636-461-5204	4.00	0.25	0.3
1-3636-461-5205	5.00	0.25	0.3
1-3636-461-5206	6.00	0.25	0.3
1-3636-461-5208	8.00	0.25	0.3
1-3636-461-5212	12.00	0.25	0.3
1-3636-461-5218	18.00	0.25	0.5
1-3636-461-5224	24.00	0.25	0.7
1-3636-461-5236	36.00	0.36	0.9
1-3636-461-5248	48.00	0.48	1.2

1-3636-461-52XX
Your Length

18 GHz SMA Male to SMA Male on 463 Q-Flex® Cable

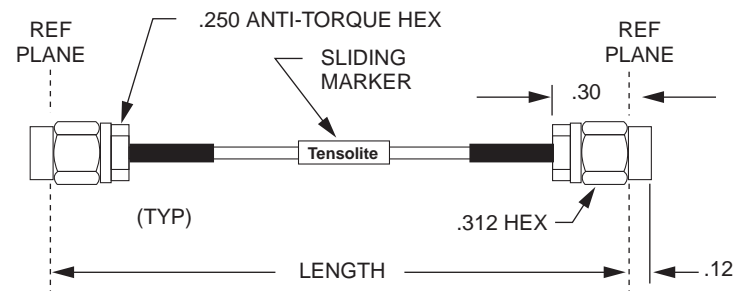

Tensolite Part Number	Length Inches	+ - Inches	Weight Ounces
1-3636-463-5204	4.00	0.25	0.5
1-3636-463-5205	5.00	0.25	0.5
1-3636-463-5206	6.00	0.25	0.6
1-3636-463-5208	8.00	0.25	0.7
1-3636-463-5212	12.00	0.25	0.9
1-3636-463-5218	18.00	0.25	1.2
1-3636-463-5224	24.00	0.25	1.6
1-3636-463-5236	36.00	0.36	2.2
1-3636-463-5248	48.00	0.48	2.9

1-3636-463-52XX
Your Length

18 GHz SMA Male to SMA Male on 465 Q-Flex® Cable

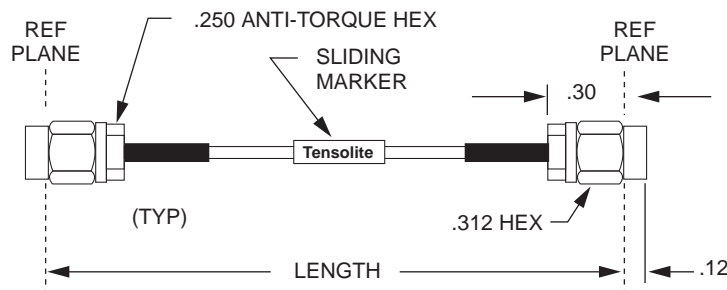

Tensolite Part Number	Length Inches	+ - Inches	Weight Ounces
1-3636-465-5204	4.00	0.25	0.7
1-3636-465-5205	5.00	0.25	0.8
1-3636-465-5206	6.00	0.25	0.9
1-3636-465-5208	8.00	0.25	1.1
1-3636-465-5212	12.00	0.25	1.6
1-3636-465-5218	18.00	0.25	2.2
1-3636-465-5224	24.00	0.25	2.9
1-3636-465-5236	36.00	0.36	4.2
1-3636-465-5248	48.00	0.48	5.5

1-3636-465-52XX
Your Length

RF Microwave Q-Flex®

Q-Flex® Series Specifications

40 GHz smK Male to smK Male on 794 Q-Flex® Cable

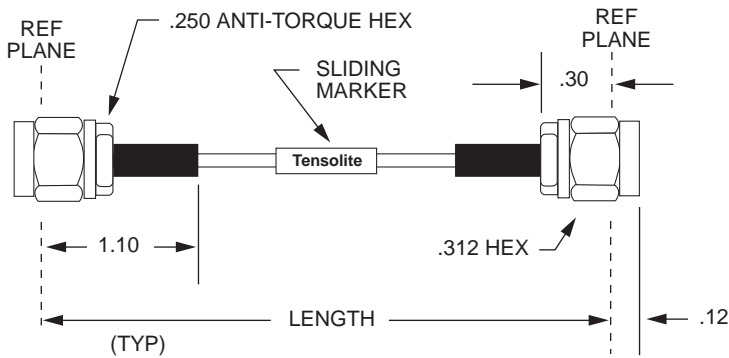

Tensolite Part Number	Length Inches	+ - Inches	Weight Ounces
1-K6K6-794-5304	4.00	0.25	0.3
1-K6K6-794-5305	5.00	0.25	0.3
1-K6K6-794-5306	6.00	0.25	0.3
1-K6K6-794-5308	8.00	0.25	0.3
1-K6K6-794-5312	12.00	0.25	0.4
1-K6K6-794-5318	18.00	0.25	0.5
1-K6K6-794-5324	24.00	0.25	0.7
1-K6K6-794-5336	36.00	0.36	0.9
1-K6K6-794-5348	48.00	0.48	1.2

1-K6K6-794-53XX

Your Length

40 GHz SMP Plug to SMP Plug on 794 Q-Flex® Cable

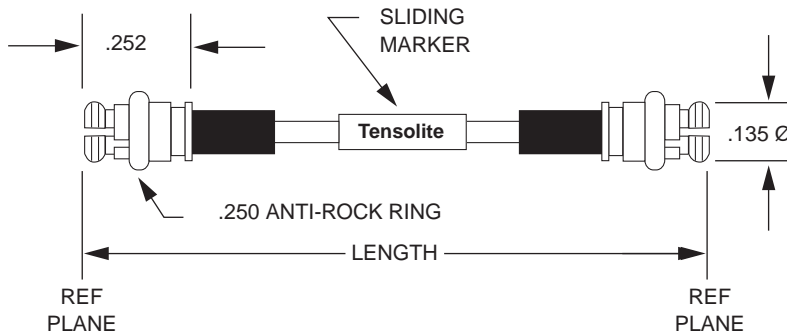

Tensolite Part Number	Length Inches	+ - Inches	Weight Ounces
1-G6G6-794-3304	4.00	0.25	0.3
1-G6G6-794-3305	5.00	0.25	0.3
1-G6G6-794-3306	6.00	0.25	0.3
1-G6G6-794-3308	8.00	0.25	0.3
1-G6G6-794-3312	12.00	0.25	0.4
1-G6G6-794-3318	18.00	0.25	0.5
1-G6G6-794-3324	24.00	0.25	0.7
1-G6G6-794-3336	36.00	0.36	0.9
1-G6G6-794-3348	48.00	0.48	1.2

1-G6G6-794-33XX

Your Length

26 GHz SMP Right Angle Plug to SMP Right Angle Plug on 794 Q-Flex® Cable

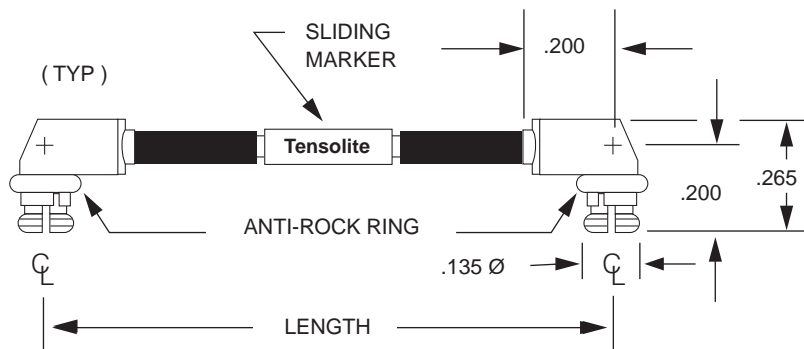

Tensolite Part Number	Length Inches	+ - Inches	Weight Ounces
1-G7G7-794-3304	4.00	0.25	0.3
1-G7G7-794-3305	5.00	0.25	0.3
1-G7G7-794-3306	6.00	0.25	0.3
1-G7G7-794-3308	8.00	0.25	0.3
1-G7G7-794-3312	12.00	0.25	0.4
1-G7G7-794-3318	18.00	0.25	0.5
1-G7G7-794-3324	24.00	0.25	0.7
1-G7G7-794-3336	36.00	0.36	0.9
1-G7G7-794-3348	48.00	0.48	1.2

1-G7G7-794-33XX

Your Length

Q-Flex® Plus Specifications

Q-Flex® Plus assemblies offer even greater flexibility for Semi-Rigid equivalent flexible coax cables. The coax is very flexible, that allows you to bend it in a tight radius without a lot of spring back. As an example, Q-Flex® Plus 561 bend force and spring back properties are only half the amount of standard flexible 405 cable. This makes it great for applications such as missile gimbals and test and measurement devices that are in tight locations.

Assembly Cable Code	Bulk Cable P/N	OD
561	LLFP-1087	.115"
563	LLFP-1141	.180"
565	LLFP-1250	.290"

Flexible Alternatives to RG 405, 402 and 401 with improved attenuation

18 GHz SMA Male to SMA Male on 561 Q-Flex® Plus Cable

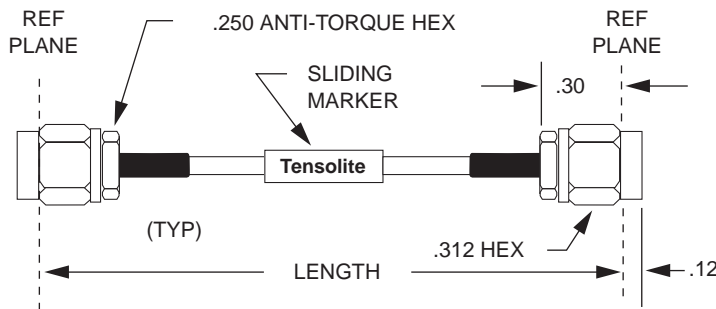

Tensolite Part Number	Length Inches	+ - Inches	Weight Ounces
1-3636-561-5204	4.00	0.25	0.3
1-3636-561-5205	5.00	0.25	0.3
1-3636-561-5206	6.00	0.25	0.3
1-3636-561-5208	8.00	0.25	0.3
1-3636-561-5212	12.00	0.25	0.4
1-3636-561-5218	18.00	0.25	0.5
1-3636-561-5224	24.00	0.25	0.7
1-3636-561-5236	36.00	0.36	0.9
1-3636-561-5248	48.00	0.48	1.2

1-3636-561-52XX
Your Length

18 GHz SMA Male to SMA Male on 563 Q-Flex® Cable

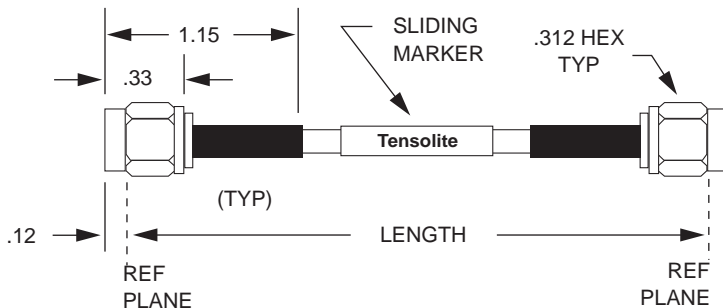

Tensolite Part Number	Length Inches	+ - Inches	Weight Ounces
1-3636-563-3204	4.00	0.3	0.5
1-3636-563-3205	5.00	0.3	0.5
1-3636-563-3206	6.00	0.25	0.6
1-3636-563-3207	7.00	0.25	0.6
1-3636-563-3208	8.00	0.25	0.7
1-3636-563-3210	10.00	0.25	0.8
1-3636-563-3212	12.00	0.25	0.9
1-3636-563-3218	18.00	0.25	1.2
1-3636-563-3224	24.00	0.25	1.6
1-3636-563-3236	36.00	0.36	2.2
1-3636-563-3248	48.00	0.48	2.9

1-3636-563-32XX
Your Length

SMA Male to SMA Male on 565 Q-Flex® Cable

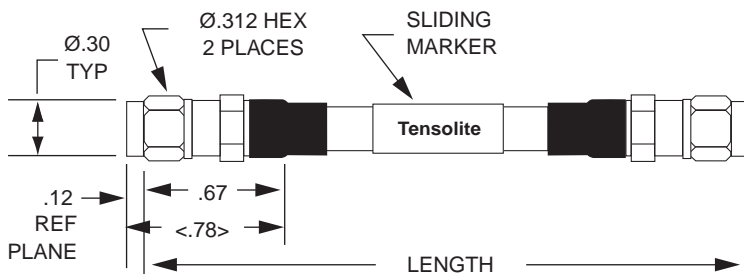

Tensolite Part Number	Length Inches	+ - Inches	Weight Ounces
1-3636-565-5105	5.00	0.05	0.8
1-3636-565-5106	6.00	0.05	0.9
1-3636-565-5107	7.00	0.10	1.0
1-3636-565-5108	8.00	0.10	1.2
1-3636-565-5112	12.00	0.10	1.6
1-3636-565-5118	18.00	0.15	2.4
1-3636-565-5124	24.00	0.20	3.1
1-3636-565-5137	37.00	0.20	4.7
1-3636-565-5148	48.00	0.25	6.0

1-3636-565-51XX
Your Length

Semi-Flex® Series

SEMI-FLEX® is a unique ALTERNATIVE to the use of Semi-Rigid coax. A tin-filled wire braid outer conductor allows easy flexing and re-bending by hand. A solid copper secondary outer conductor and Semi-Rigid style core ensure electrical performance comparable to Semi-Rigid.

No significant electrical degradation occurs when SEMI-FLEX® is formed! The cable retains its shape, making installations simple.

Assembly Cable Code	Bulk Cable P/N	OD
604	7-1114-604-18	.047"
600	7-1114-600-18	.086"
601	7-1114-601-18	.141"
606	7-1114-606-18	.250"

18 GHz SMA Male to SMA Male on 604 Semi-Flex® Cable

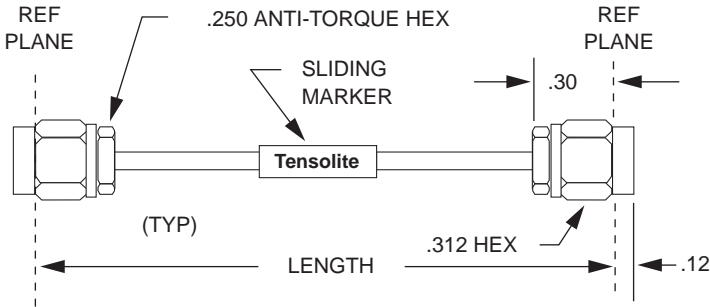

Tensolite Part Number	Length Inches	+ - Inches	Weight Ounces
1-3636-604-5206	6.00	0.10	0.2
1-3636-604-5209	9.00	0.10	0.2
1-3636-604-5212	12.00	0.15	0.3
1-3636-604-5218	18.00	0.15	0.3
1-3636-604-5224	24.00	0.15	0.3
1-3636-604-5236	36.00	0.20	0.4
1-3636-604-5248	48.00	0.20	0.4
1-3636-604-5260	60.00	0.20	0.5
1-3636-604-5272	72.00	0.20	0.5

1-3636-604-52XX

Your Length

18 GHz SMA Male to SMA Male on 600 Semi-Flex® Cable

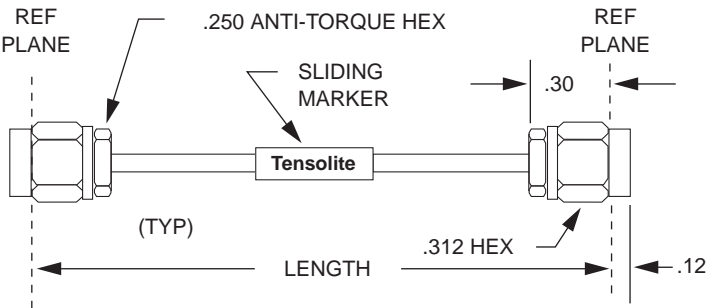

Tensolite Part Number	Length Inches	+ - Inches	Weight Ounces
1-3636-600-5204	4.00	0.05	0.2
1-3636-600-5205	5.00	0.10	0.3
1-3636-600-5206	6.00	0.10	0.3
1-3636-600-5208	8.00	0.10	0.3
1-3636-600-5212	12.00	0.15	0.4
1-3636-600-5218	18.00	0.15	0.5
1-3636-600-5224	24.00	0.15	0.6
1-3636-600-5236	36.00	0.20	0.8
1-3636-600-5248	48.00	0.25	1.0

1-3636-600-52XX

Your Length

18 GHz SMA Male to SMA Male on 601 Semi-Flex® Cable

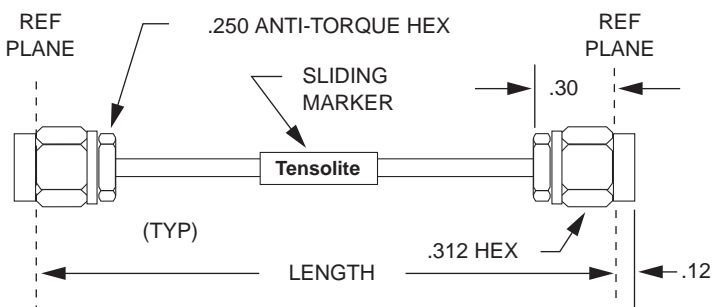

Tensolite Part Number	Length Inches	+ - Inches	Weight Ounces
1-3636-601-5204	4.00	0.05	0.3
1-3636-601-5205	5.00	0.10	0.3
1-3636-601-5206	6.00	0.10	0.4
1-3636-601-5208	8.00	0.10	0.4
1-3636-601-5212	12.00	0.15	0.6
1-3636-601-5218	18.00	0.15	0.8
1-3636-601-5224	24.00	0.15	0.9
1-3636-601-5236	36.00	0.20	1.3
1-3636-601-5248	48.00	0.25	1.7

1-3636-601-52XX

Your Length

Semi-Flex® Series Specifications

18 GHz SMA Male Right Angle to Right Angle on 600 Semi-Flex® Cable

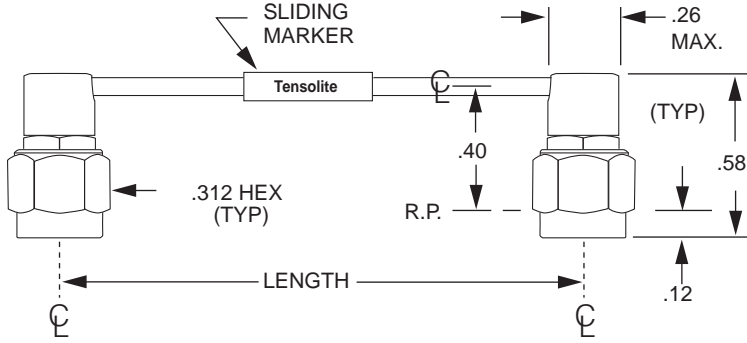

Tensolite Part Number	Length Inches	+ - Inches	Weight Ounces
1-3737-600-3204	4.00	0.05	0.3
1-3737-600-3205	5.00	0.05	0.4
1-3737-600-3206	6.00	0.05	0.4
1-3737-600-3208	8.00	0.10	0.4
1-3737-600-3212	12.00	0.10	0.5
1-3737-600-3218	18.00	0.15	0.5
1-3737-600-3224	24.00	0.15	0.6
1-3737-600-3236	36.00	0.15	0.8
1-3737-600-3248	48.00	0.20	1.0

1-3737-600-52XX
Your Length

18 GHz SMA Male to SMA Male Right Angle on 600 Semi-Flex® Cable

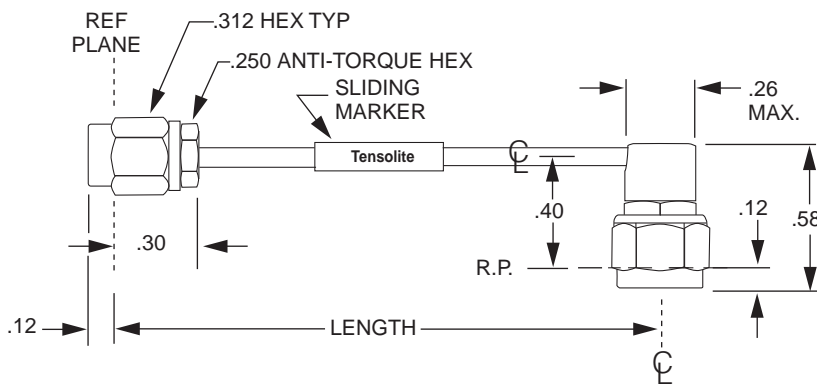

Tensolite Part Number	Length Inches	+ - Inches	Weight Ounces
1-3637-600-5204	4.00	0.05	0.2
1-3637-600-5205	5.00	0.10	0.3
1-3637-600-5206	6.00	0.10	0.3
1-3637-600-5208	8.00	0.10	0.3
1-3637-600-5212	12.00	0.15	0.4
1-3637-600-5218	18.00	0.15	0.4
1-3637-600-5224	24.00	0.15	0.5
1-3637-600-5236	36.00	0.20	0.7
1-3637-600-5248	48.00	0.25	0.9

1-3637-600-52XX
Your Length

6 GHz SMA Male to MCX Male Right Angle on 600 Semi-Flex® Cable

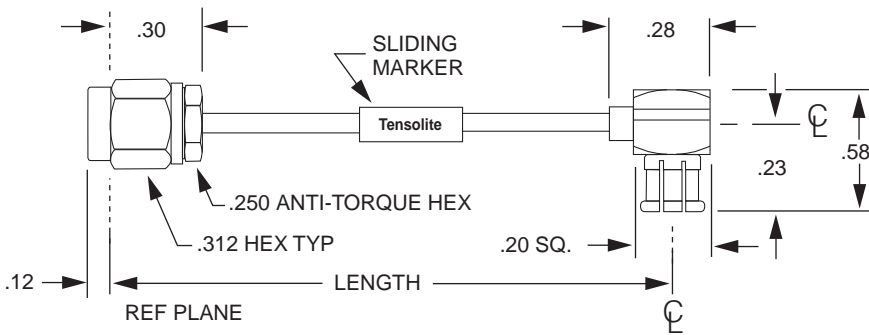

Tensolite Part Number	Length Inches	+ - Inches	Weight Ounces
1-36M7-600-5204	4.00	0.25	0.3
1-36M7-600-5205	5.00	0.25	0.3
1-36M7-600-5206	6.00	0.25	0.3
1-36M7-600-5208	8.00	0.25	0.3
1-36M7-600-5212	12.00	0.25	0.4
1-36M7-600-5218	18.00	0.25	0.5
1-36M7-600-5224	24.00	0.24	0.6
1-36M7-600-5236	36.00	0.36	0.8
1-36M7-600-5248	48.00	0.48	0.9

1-36M7-600-52XX
Your Length

RF Microwave Semi-Flex®

Semi-Flex® Series Specifications

40 GHz SMP Plug to SMP Plug on 600 Semi-Flex® Cable

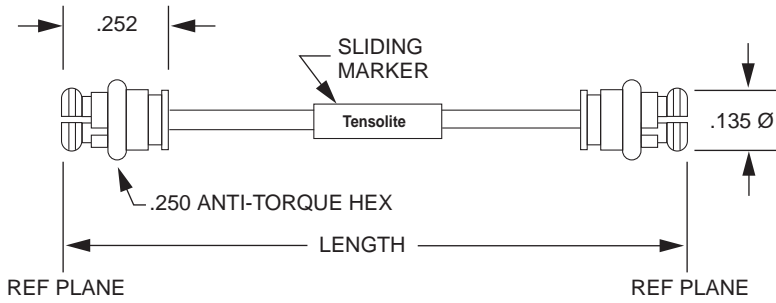

Tensolite Part Number	Length Inches	+ - Inches	Weight Ounces
1-G6G6-600-3404	4.00	0.05	0.2
1-G6G6-600-3405	5.00	0.10	0.3
1-G6G6-600-3406	6.00	0.10	0.3
1-G6G6-600-3408	8.00	0.10	0.3
1-G6G6-600-3412	12.00	0.15	0.4
1-G6G6-600-3418	18.00	0.15	0.5
1-G6G6-600-3424	24.00	0.15	0.6
1-G6G6-600-3436	36.00	0.20	0.8
1-G6G6-600-3448	48.00	0.25	1.0

1-G6G6-600-34XX
Your Length

26.5 GHz SMP Right Angle Plug to SMP Right Angle Plug on 600 Semi-Flex® Cable

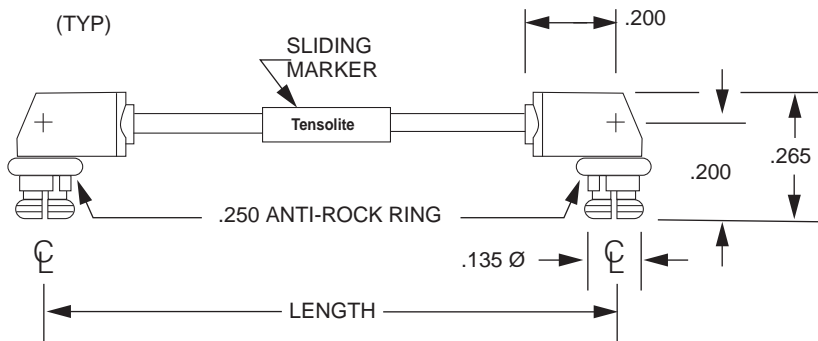

Tensolite Part Number	Length Inches	+ - Inches	Weight Ounces
1-G7G7-600-3304	4.00	0.05	0.2
1-G7G7-600-3305	5.00	0.10	0.3
1-G7G7-600-3306	6.00	0.10	0.3
1-G7G7-600-3308	8.00	0.10	0.3
1-G7G7-600-3312	12.00	0.15	0.4
1-G7G7-600-3318	18.00	0.15	0.5
1-G7G7-600-3324	24.00	0.15	0.6
1-G7G7-600-3336	36.00	0.20	0.8
1-G7G7-600-3348	48.00	0.25	1.0

1-G7G7-600-33XX
Your Length

18 GHz Type N Male to Type N Male on 606 Semi-Flex® Cable

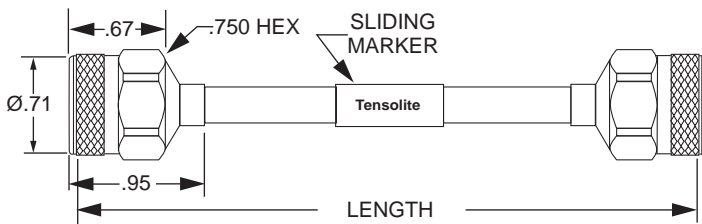

Tensolite Part Number	Length Inches	+ - Inches	Weight Ounces
1-1818-606-3204	4.00	0.10	2.56
1-1818-606-3205	5.00	0.10	2.68
1-1818-606-3206	6.00	0.10	2.80
1-1818-606-3208	8.00	0.10	3.05
1-1818-606-3212	12.00	0.10	3.53
1-1818-606-3218	18.00	0.15	4.26
1-1818-606-3224	24.00	0.15	4.99
1-1818-606-3236	36.00	0.15	6.44
1-1818-606-3248	48.00	0.20	7.90

1-1818-606-32XX
Your Length

Semi-Flex® Plus Series

Semi-Flex® Plus allows the user to have the advantages of a hand formable cable and a flexible cable all in one. Semi-Flex® Plus enhances Tensolite's Semi-Flex® by using a clear polyurethane jacket over a tin-filled wire braid outer conductor. A solid secondary outer conductor and Semi-Rigid style core ensure electrical performance comparable to Semi-Rigid. If your application calls for High Temperature, use our Semi-Flex® Plus "High Temperature" 650 or 651 Series (-50 to 200° C) by adding our FEP jacket.

Assembly Cable Code OD

620	.112"
621	.180"
650	.100"

18 GHz SMA Male to SMA Male on 620 Jacketed Semi-Flex® Cable

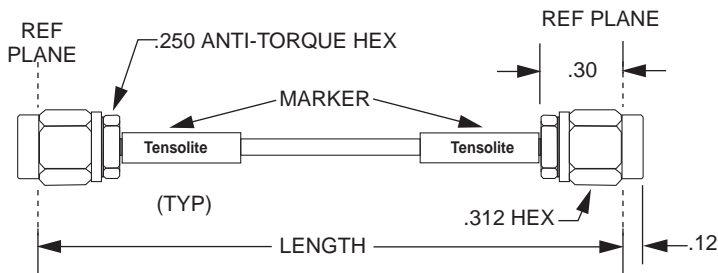

Tensolite Part Number	Length Inches	+ - Inches	Weight Ounces
1-3636-620-5204	4.00	0.05	0.3
1-3636-620-5205	5.00	0.05	0.3
1-3636-620-5206	6.00	0.10	0.3
1-3636-620-5208	8.00	0.10	0.3
1-3636-620-5212	12.00	0.15	0.4
1-3636-620-5218	18.00	0.15	0.5
1-3636-620-5224	24.00	0.15	0.7
1-3636-620-5236	36.00	0.15	0.9
1-3636-620-5248	48.00	0.20	1.1

1-3636-620-52XX
Your Length

18 GHz SMA Male Right Angles on 620 Semi-Flex® Plus Cable

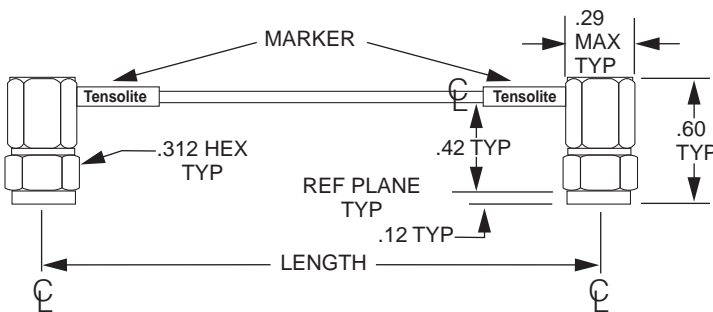

Tensolite Part Number	Length Inches	+ - Inches	Weight Ounces
1-3737-620-3204	4.00	0.05	0.4
1-3737-620-3205	5.00	0.05	0.4
1-3737-620-3206	6.00	0.10	0.4
1-3737-620-3208	8.00	0.10	0.4
1-3737-620-3212	12.00	0.15	0.5
1-3737-620-3218	18.00	0.15	0.6
1-3737-620-3224	24.00	0.15	0.8
1-3737-620-3236	36.00	0.15	1.0
1-3737-620-3248	48.00	0.20	1.2

1-3737-620-32XX
Your Length

18 GHz type N Male to Type N Male on 621 Jacketed Semi-Flex® Cable

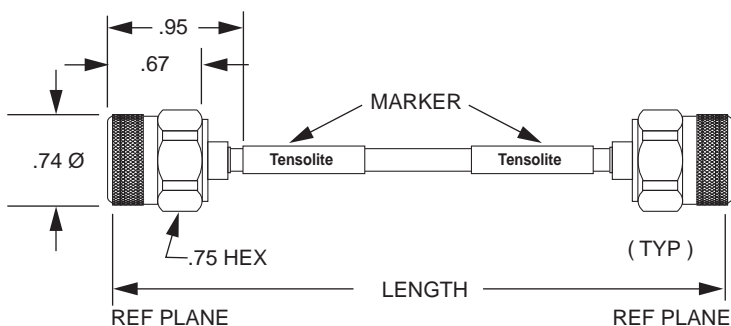

Tensolite Part Number	Length Inches	+ - Inches	Weight Ounces
1-1818-621-3204	4.00	0.05	2.2
1-1818-621-3205	5.00	0.05	2.2
1-1818-621-3206	6.00	0.05	2.3
1-1818-621-3208	8.00	0.10	2.4
1-1818-621-3212	12.00	0.10	2.5
1-1818-621-3218	18.00	0.15	2.7
1-1818-621-3224	24.00	0.15	2.9
1-1818-621-3236	36.00	0.15	3.3
1-1818-621-3248	48.00	0.20	3.7

1-1818-621-32XX
Your Length

Semi-Flex® II Series Specifications

Semi-Flex® II is a thin walled, soft aluminum jacketed Semi-Rigid cable. The more pliable outer conductor allows easier forming than copper jacketed cable while retaining much of the same electrical performance.

Semi-Flex® II, along with original, high performance Semi-Flex®, rounds out the designer's options for alternatives to traditional Semi-Rigid cable assemblies.

Assembly Cable Code	OD
617	.086"
618	.141"

18 GHz SMA Male to SMA Male on 617 Semi-Flex® II Cable

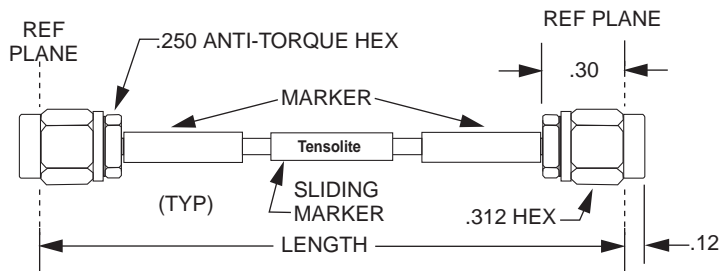

Tensolite Part Number	Length Inches	+ - Inches	Weight Ounces
1-3636-617-5204	4.00	0.05	0.2
1-3636-617-5205	5.00	0.10	0.2
1-3636-617-5206	6.00	0.10	0.2
1-3636-617-5208	8.00	0.10	0.3
1-3636-617-5212	12.00	0.15	0.3
1-3636-617-5218	18.00	0.15	0.4
1-3636-617-5224	24.00	0.15	0.4
1-3636-617-5236	36.00	0.20	0.6
1-3636-617-5248	48.00	0.25	0.7

1-3636-617-52XX
Your Length

18 GHz SMA Male to SMA Male on 618 Semi-Flex® II Cable

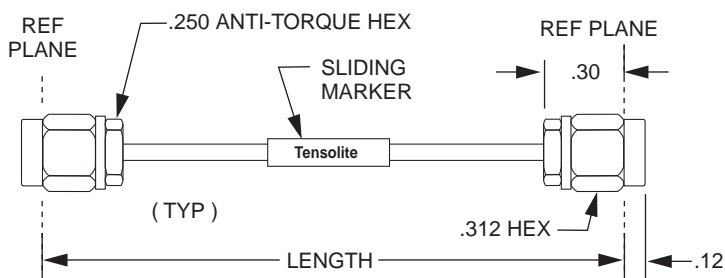

Tensolite Part Number	Length Inches	+ - Inches	Weight Ounces
1-3636-618-5204	4.00	0.05	1.1
1-3636-618-5205	5.00	0.10	1.3
1-3636-618-5206	6.00	0.10	1.5
1-3636-618-5208	8.00	0.10	2.0
1-3636-618-5212	12.00	0.15	2.9
1-3636-618-5218	18.00	0.15	4.3
1-3636-618-5224	24.00	0.15	5.7
1-3636-618-5236	36.00	0.20	8.4
1-3636-618-5248	48.00	0.25	11.1

1-3636-618-52XX
Your Length

The Workhorse® Family is the result of Tensolite's years of assembly experience coupled with the demand for lower cost products. The Workhorse® assembly uses the time proven "504" cable, the Workhorse® Plus utilizes the "524" cable that provides better flexibility, and the Low Loss Workhorse® uses Tensolite's 301 Low Loss cable. All Workhorse® assemblies utilize our most rugged stainless steel connectors and a new extremely durable, yet cost effective attachment method.

18 and 26.5 GHz Cable Assemblies

Features:

- Extremely durable and long lasting connector attachment method
- Excellent high frequency response
- Phase stable with flexure
- Standard lengths in stock

Type N Male to Type N Male on Work horse® Cable

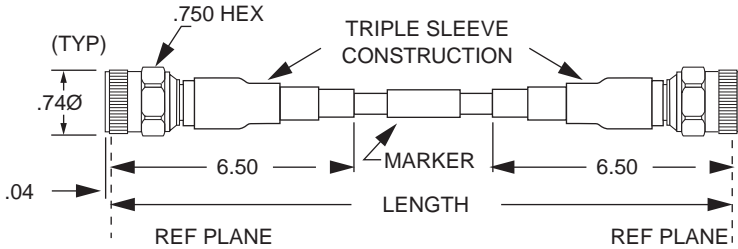

Tensolite Part Number	Length Inches	+ - Inches	Weight Ounces
WHU18-1818-024	24.00	0.25	5.3
WHU18-1818-030	30.00	0.30	5.6
WHU18-1818-036	36.00	0.36	5.9
WHU18-1818-042	42.00	0.42	6.3
WHU18-1818-048	48.00	0.48	6.6
WHU18-1818-072	72.00	0.72	8.0
WHU18-1818-120	120.00	1.20	10.8

WHU18-1818-XXX

Your Length

Type N to SMA Male on Work horse® Cable

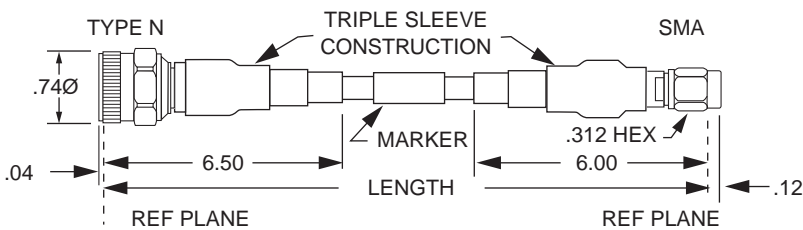

Tensolite Part Number	Length Inches	+ - Inches	Weight Ounces
WHU18-1836-024	24.00	0.25	4.8
WHU18-1836-030	30.00	0.30	5.1
WHU18-1836-036	36.00	0.36	5.4
WHU18-1836-042	42.00	0.42	5.8
WHU18-1836-048	48.00	0.48	6.1
WHU18-1836-072	72.00	0.72	7.5
WHU18-1836-120	120.00	1.20	10.3

WHU18-1836-XXX

Your Length

SMA Males on Work horse® Cable

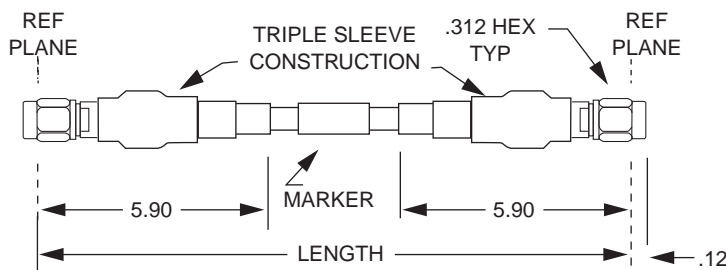

Tensolite Part Number	Length Inches	+ - Inches	Weight Ounces
WHU18-3636-024	24.00	0.25	3.7
WHU18-3636-030	30.00	0.30	4.0
WHU18-3636-036	36.00	0.36	4.3
WHU18-3636-042	42.00	0.42	4.7
WHU18-3636-048	48.00	0.48	5.0
WHU18-3636-072	72.00	0.72	6.4
WHU18-3636-120	120.00	1.20	9.2

WHU18-3636-XXX

Your Length

Type N Male to N Male on Work horse® Plus Cable

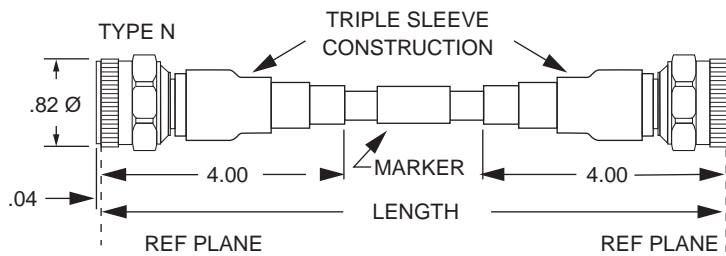

Tensolite Part Number	Length Inches	+ - Inches	Weight Ounces
1-1818-524-WH 24	24.00	0.25	5.4
1-1818-524-WH 30	30.00	0.30	5.8
1-1818-524-WH 36	36.00	0.36	6.1
1-1818-524-WH 39	39.4	0.39	6.3
1-1818-524-WH 48	48.00	0.48	6.9
1-1818-524-WH 72	72.00	0.72	8.4
2-1818-524-WH 10	120.00	1.20	11.4

1-1818-524-WH XX

Your Length →

Type N Male to Hybrid SMA Male on Work horse® Plus Cable

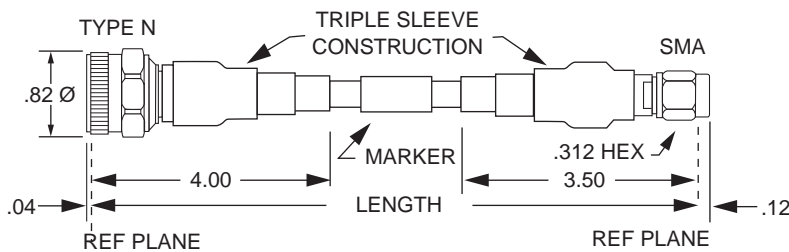

Tensolite Part Number	Length Inches	+ - Inches	Weight Ounces
1-1836-524-WH 24	24.00	0.25	5.4
1-1836-524-WH 30	30.00	0.30	5.8
1-1836-524-WH 36	36.00	0.36	6.1
1-1836-524-WH 42	39.00	0.39	6.3
1-1836-524-WH 48	48.00	0.48	6.9
1-1836-524-WH 72	72.00	0.72	8.4
2-1836-524-WH 10	120.00	1.20	11.4

1-1836-524-WH XX

Your Length →

Hybrid SMA Male to SMA Male on Work horse® Plus Cable

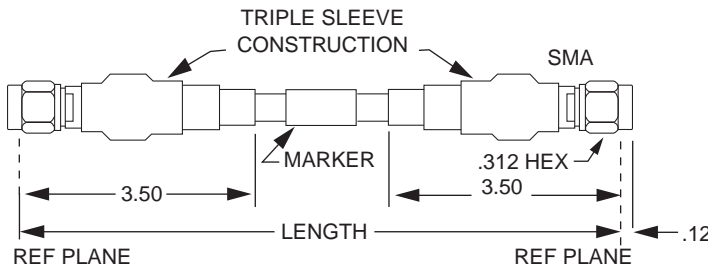

Tensolite Part Number	Length Inches	+ - Inches	Weight Ounces
1-3636-524-WH 24	24.00	0.25	5.4
1-3636-524-WH 30	30.00	0.25	5.8
1-3636-524-WH 36	36.00	0.36	6.1
1-3636-524-WH 42	42.00	0.42	6.5
1-3636-524-WH 48	48.00	0.48	6.9
1-3636-524-WH 72	72.00	0.72	8.4
2-3636-524-WH 10	120.00	1.20	11.4

1-3636-524-WH XX

Your Length →

Workhorse® 40 Armored Cable

The Tensolite "Workhorse 40" Armored Cable Assembly is designed to perform in high volume, strenuous test environments. Its rugged design provides protection from wear and tear reducing the need for costly replacement test cables.

Tensolite's years of assembly experience combined with a demand for lower cost production solutions resulted in the development of the "Workhorse 40".

The "Workhorse 40" utilizes a new Tensolite "550" cable encased in a stainless steel, crush resistant armor. The "550" cable provides low loss and low VSWR, while maintaining phase stability.

Tensolite designed "SMK"(2.92) tough stainless steel connectors combined with the "550" cable deliver more tests with maximum accuracy and repeatability.

The "Workhorse 40" Armored assembly will stand the test of time!

Typical VSWR 1.35:1 @ 40 GHz
 Typical Loss 2dB per foot,
 Assembly Temperature Rating - 50°C to +105°C

Intended Applications:

- High Volume Test Lab
- Vector Network Analyzer
- Calibration
- Antenna Range
- Custom Applications

2.92MM males on 40GHz Work horse® Cable

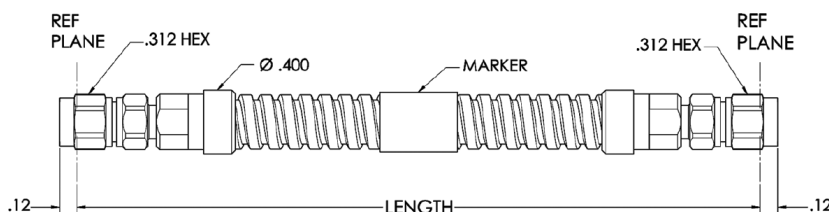

ELECTRICAL SPECIFICATIONS	
IMPEDANCE, NOMINAL:	50 OHMS
CAPACITANCE NOMINAL:	28.0 pF/FOOT
VELOCITY OF PROPAGATION, NOMINAL:	70.5 %
RELATIVE SHIELDING:	-100.0 dB MIN.
INSULATION RESISTANCE:	1000 MEGOHMS MIN.
DIELECTRIC WITHSTANDING VOLTAGE:	1069 VRMS MAX.
ELECTRICAL DELAY, NOMINAL:	1.44 ns/FOOT
ELECTRICAL DELAY, NOMINAL:	120 ps/INCH
F (IN GHz) ----->	2 6 12 18 26 40
MAX. CW WATTS ----->	54 30 20 16 12 9

MECHANICAL SPECIFICATIONS:	
CABLE MAX. DIAMETER:	0.350 INCHES
MINIMUM BEND RADIUS:	2.10 INCHES
CONNECTOR RETENTION:	60 POUNDS MIN.
TEMPERATURE RANGE:	-55 to +105 DEGREES C
MATING TORQUE:	7-10 INCH POUNDS
CONNECTOR INTERFACE:	IEEE-STD-287

MATERIALS AND FINISHES		
DESCRIPTION	MATERIAL	FINISH OR COLOR
ARMOR:	STAINLESS STEEL STRIP	NONE
CONTACTS:	ASTM-B196, BeCu C173	ASTM B-488, GOLD PLATED
BEAD:	NORYL	NONE
BODY CABLE ENTRY:	ASTM-A-582, 303 STAINLESS STEEL	ASTM A-967, PASSIVATED
BODY:	ASTM-A-582, 303 STAINLESS STEEL	ASTM A-967, PASSIVATED
NUT:	ASTM-A-582, 303 STAINLESS STEEL	ASTM A-967, PASSIVATED
RETAINING RING:	ASTM-B196, BeCu C173	NONE
AVAILABLE GASKET:	ZZ-R-765, SILICON RUBBER	RED
SOLVENTS:	NO OZONE DEPLETING MATERIALS ARE USED	

PART NUMBER	LENGTH INCHES	+ - LENGTH	WEIGHT OUNCES	MAXIMUM VSWR :1 AT FREQUENCY (IN GHz.)						MAXIMUM INSERTION LOSS IN dB AT FREQ. (IN GHz.)						LENGTH CM	
				UP TO 2	2 TO 6	6 TO 12	12 TO 18	18 TO 26	26 TO 40	UP TO 2	2 TO 6	6 TO 12	12 TO 18	18 TO 26	26 TO 40		
WHA40-K6K6-0 24	S	24.0	0.25	4.5	1.08	1.12	1.20	1.25	1.32	1.35	0.75	1.35	2.01	2.57	3.22	4.39	61.0
WHA40-K6K6-0 30		30.0	0.30	4.6	1.08	1.12	1.20	1.25	1.32	1.35	0.91	1.65	2.45	3.14	3.94	5.33	76.2
WHA40-K6K6-0 36	S	36.0	0.36	4.8	1.08	1.12	1.20	1.25	1.32	1.35	1.07	1.95	2.90	3.71	4.65	6.28	91.4
WHA40-K6K6-0 42		42.0	0.42	4.9	1.08	1.12	1.20	1.25	1.32	1.35	1.23	2.25	3.35	4.28	5.37	7.22	106.7
WHA40-K6K6-0 48	S	48.0	0.48	5.1	1.08	1.12	1.20	1.25	1.32	1.35	1.39	2.55	3.79	4.85	6.08	8.16	121.9
WHA40-K6K6-0 54		54.0	0.54	5.2	1.12	1.15	1.23	1.28	1.33	1.38	1.56	2.84	4.24	5.42	6.80	9.11	137.2
WHA40-K6K6-0 60		60.0	0.60	5.4	1.12	1.15	1.23	1.28	1.33	1.38	1.72	3.14	4.69	5.99	7.52	10.05	152.4
WHA40-K6K6-0 66		66.0	0.66	5.5	1.12	1.15	1.23	1.28	1.33	1.38	1.88	3.44	5.13	6.56	8.23	10.99	167.6
WHA40-K6K6-0 72		72.0	0.72	5.7	1.12	1.15	1.23	1.28	1.33	1.38	2.04	3.74	5.58	7.13	8.95	11.94	182.9
WHA40-K6K6-0 78		78.0	0.78	5.9	1.12	1.15	1.23	1.28	1.33	1.38	2.20	4.04	6.03	7.70	9.67	12.88	198.1
WHA40-K6K6-0 84		84.0	0.84	6.0	1.12	1.15	1.23	1.28	1.33	1.38	2.36	4.33	6.47	8.27	10.38	13.82	213.4
WHA40-K6K6-0 90		90.0	0.90	6.2	1.12	1.15	1.23	1.28	1.33	1.38	2.53	4.63	6.92	8.84	11.10	14.77	228.6
WHA40-K6K6-0 96		96.0	0.96	6.3	1.12	1.15	1.23	1.28	1.33	1.38	2.69	4.93	7.36	9.41	11.81	15.71	243.8
WHA40-K6K6-1 20		120.0	1.20	6.9	1.13	1.18	1.25	1.31	1.36	1.41	3.33	6.12	9.15	11.69	14.68	19.48	304.8

S = STANDARD ITEM MAXIMUM SPECIFICATIONS ARE PRODUCT MAXIMUM INCLUDING MEASURING SYSTEM UNCERTAINTY.
 NOTE: PRODUCT SPECIFICATIONS ARE VERIFIED AT 73 DEG. F, SEA LEVEL AND 20 TO 80% RELATIVE HUMIDITY.
 PRODUCT SPECIFICATIONS APPLY AT 5 TO 99% (NON CONDENSING) RELATIVE HUMIDITY, CONSULT FACTORY FOR PRODUCT CHARACTERISTICS AT OTHER CONDITIONS.
 WORKHORSE IS A REGISTERED TRADEMARK OF TENSOLITE CO.
 VISIT OUR WEB SITE AT <http://www.tensolite.com>

Low Loss Workhorse®

Type N Males on Low Loss Workhorse® Cable

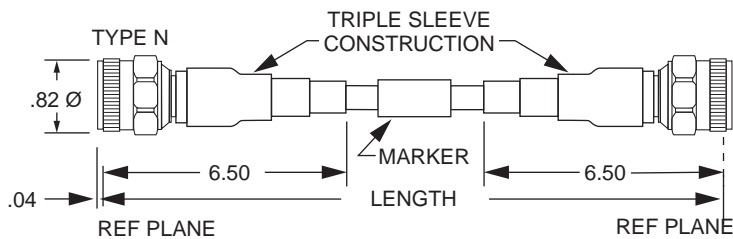

Tensolite Part Number	Length Inches	+ - Inches	Weight Ounces
WLU18-1818-024	24.00	0.25	4.6
WLU18-1818-030	30.00	0.30	4.9
WLU18-1818-036	36.00	0.36	5.2
WLU18-1818-042	42.00	0.42	5.4
WLU18-1818-048	48.00	0.48	5.7
WLU18-1818-072	72.00	0.72	6.8
WLU18-1818-120	120.00	1.20	9.1

WLU18-1818-XXX

Your Length →

Type N and SMA Males on Low Loss Workhorse® Cable

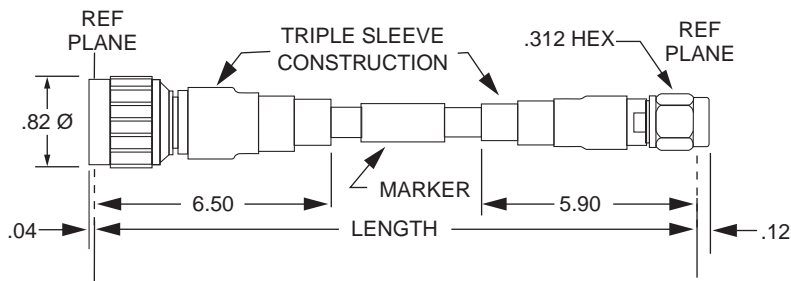

Tensolite Part Number	Length Inches	+ - Inches	Weight Ounces
WLU18-1836-024	24.00	0.25	4.5
WLU18-1836-030	30.00	0.30	4.8
WLU18-1836-036	36.00	0.36	5.1
WLU18-1836-042	42.00	0.42	5.3
WLU18-1836-048	48.00	0.48	5.6
WLU18-1836-072	72.00	0.72	6.7
WLU18-1836-120	120.00	1.20	9.0

WLU18-1836-XXX

Your Length →

SMA Males on Low Loss Workhorse® Cable

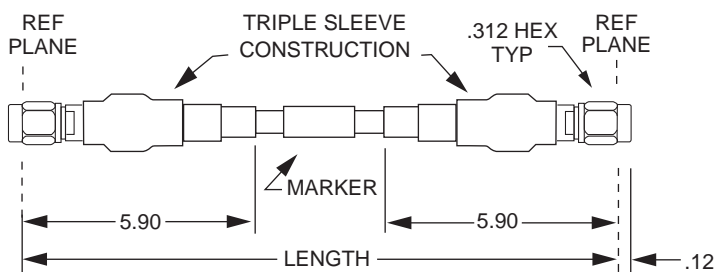

Tensolite Part Number	Length Inches	+ - Inches	Weight Ounces
WLU18-3636-024	24.00	0.25	3.4
WLU18-3636-030	30.00	0.30	3.7
WLU18-3636-036	36.00	0.36	4.0
WLU18-3636-042	42.00	0.42	4.2
WLU18-3636-048	48.00	0.48	4.5
WLU18-3636-072	72.00	0.72	5.6
WLU18-3636-120	120.00	1.20	7.9

WLU18-3636-XXX

Your Length →

The Armored Workhorse®

The Armored Workhorse® features a stainless steel, crush-proof jacket that protects the Tensolite "504" cable from everyday wear and tear associated with a lab environment. Combined with our rugged stainless steel connector series, this provides an extremely durable test cable for high temperature testing and very high volume production lines.

Features:

- "Armored" for even greater protection
- Excellent high frequency response
- Phase stable with flexure
- Standard lengths in stock

Type N Males on Armored Workhorse® Cable

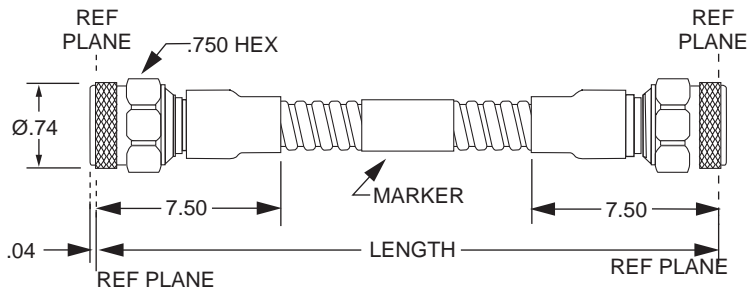

Tensolite Part Number	Length Inches	+ - Inches	Weight Ounces
WHA18-1818-024	24.00	0.25	7.1
WHA18-1818-030	30.00	0.30	7.8
WHA18-1818-036	36.00	0.36	8.6
WHA18-1818-042	42.00	0.42	9.4
WHA18-1818-048	48.00	0.48	10.2
WHA18-1818-072	72.00	0.72	13.4
WHA18-1818-120	120.00	1.20	19.8

WHA18-1818-XXX

Your Length

Type N Male to SMA Male on Armored Workhorse® Cable

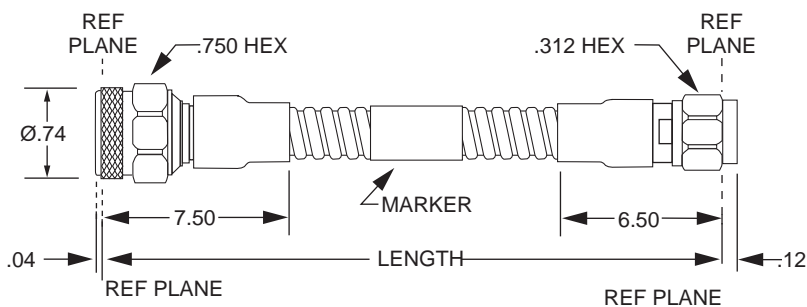

Tensolite Part Number	Length Inches	+ - Inches	Weight Ounces
WHA18-1836-024	24.00	0.25	6.6
WHA18-1836-030	30.00	0.30	7.3
WHA18-1836-036	36.00	0.36	8.1
WHA18-1836-042	42.00	0.42	8.9
WHA18-1836-048	48.00	0.48	9.7
WHA18-1836-072	72.00	0.72	12.9
WHA18-1836-120	120.00	1.20	19.3

WHA1818-1836-XXX

Your Length

SMA Males on Armored Workhorse® Cable

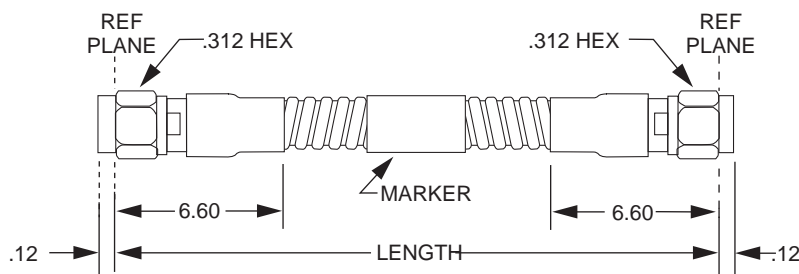

Tensolite Part Number	Length Inches	+ - Inches	Weight Ounces
WHA18-3636-024	24.00	0.25	6.2
WHA18-3636-030	30.00	0.30	6.9
WHA18-3636-036	36.00	0.36	7.7
WHA18-3636-042	42.00	0.42	8.5
WHA18-3636-048	48.00	0.48	9.3
WHA18-3636-072	72.00	0.72	12.5
WHA18-3636-120	120.00	1.20	18.9

WHA18-3636-XXX

Your Length

Low Cost, Low Loss 18GHz 301 Cable Assemblies

Tensolite's newly developed LOW COST, LOW LOSS "301" cable ends the 3-way compromise users face when defining insertion loss for higher frequency, flexible cable assemblies. Historically, low loss meant high price or reduced flexibility. "301" cable is a microporous PTFE design in .200" diameter that offers all three advantages: low loss, low price and excellent flexibility.

"301" LOW COST, LOW LOSS assemblies help the designer achieve system performance goals while retaining the flexibility of braided cables. Alternatively, "301" cables may be used to replace .141" diameter Semi-Rigid or .250" diameter corrugated copper cables.

Features:

- Low insertion loss
- Microporous PTFE dielectric
- Increased flexibility
- Standard lengths in stock

SMA Male to SMA Male on 301 Cable

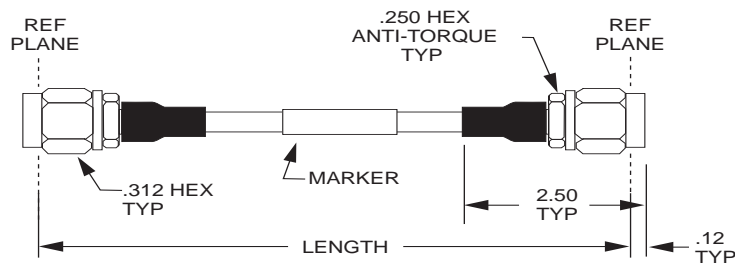

Tensolite Part Number	Length Inches	+ - Inches	Weight Ounces
1-3636-301-3206	6.00	0.25	1.5
1-3636-301-3212	12.00	0.25	1.8
1-3636-301-3218	18.00	0.25	2.2
1-3636-301-3224	24.00	0.25	2.5
1-3636-301-3248	48.00	0.48	3.8

1-3636-301-32XX
Your Length

Type N Male to SMA Male on 301 Cable

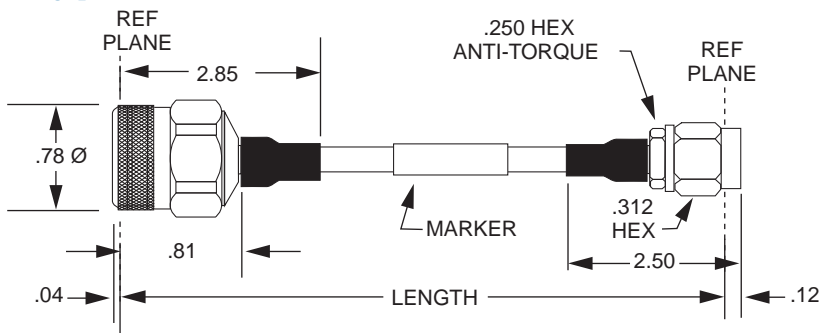

Tensolite Part Number	Length Inches	+ - Inches	Weight Ounces
1-1836-301-3206	6.00	0.25	1.5
1-1836-301-3212	12.00	0.25	1.8
1-1836-301-3218	18.00	0.25	2.2
1-1836-301-3224	24.00	0.25	2.5
1-1836-301-3236	36.00	0.36	3.1
1-1836-301-3248	48.00	0.48	3.8

1-1836-301-32XX
Your Length

Type N Male to Type N Male on 301 Cable

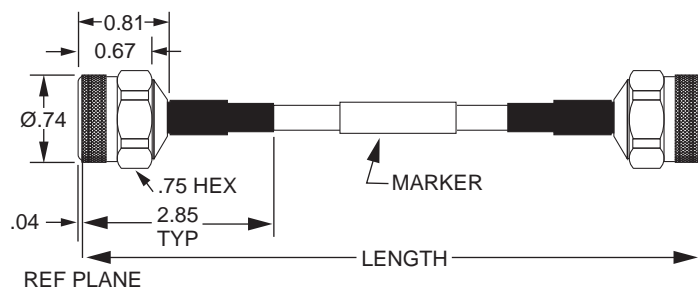

Tensolite Part Number	Length Inches	+ - Inches	Weight Ounces
1-1818-301-3206	6.00	0.25	2.4
1-1818-301-3212	12.00	0.25	2.8
1-1818-301-3218	18.00	0.25	3.1
1-1818-301-3224	24.00	0.25	3.5
1-1818-301-3236	36.00	0.36	4.2
1-1818-301-3248	48.00	0.48	4.9

1-1818-301-32XX
Your Length

TNC Male to TNC Male on 301 Cable

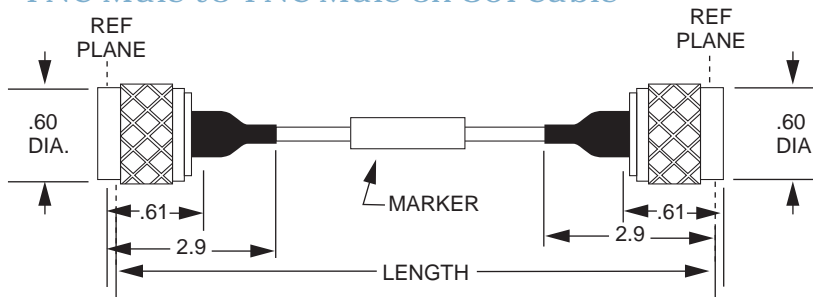

Tensolite Part Number	Length Inches	+ - Inches	Weight Ounces
1-3030-301-3206	6.00	0.05	2.4
1-3030-301-3212	12.00	0.10	2.7
1-3030-301-3218	18.00	0.15	3.0
1-3030-301-3224	24.00	0.15	3.4
1-3030-301-3236	36.00	0.15	4.0
1-3030-301-3248	48.00	0.20	4.6

1-3030-301-32XX
Your Length

RF Microwave Low Cost, Low Loss

HIGH-DENSITY, HIGH-SPEED 2MM BOARD-TO-BACKPLANE INTERCONNECT SYSTEM

Mechanical

On-Center Spacing 2.0 mm
 Mating Pin Length 3 to 8 mm
 Mating Pin Dimensions 0.40 mm X 0.40 mm
 Insertion Force, Per Contact 0.75 N, max.
 Withdrawal Force, Per Contact 0.15 N, min.
 Normal Force, Per Contact 0.70 N
 Cable Retention Force 22 N
 Durability (Insertions / Withdrawals) 250 cycles

Electrical

Insulation Resistance 100 M Ω , min.
 Dielectric Withstanding Voltage 500 V
 Voltage Rating 250 VAC
 Current Rating, @ 70°C Per Contact 1.0 A
 Contact Resistance 20 m Ω , min.

Materials

Shield Beryllium Copper
 Contacts Beryllium Copper
 Dielectric, per UL 94V-O Glass-Filled Modified PET

Plating

Contacts — Ni all over 1.27 μ m, min.
 Au all over 1.27 μ m

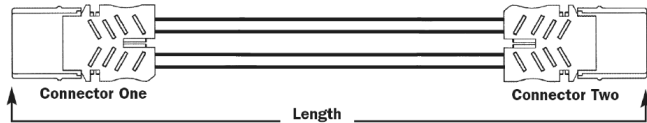
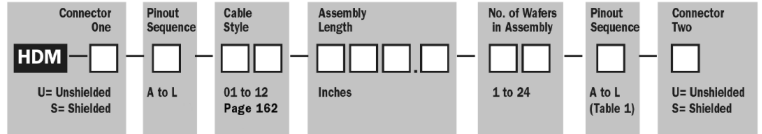

TABLE 1 - AVAILABLE PINOUT SEQUENCES

WAFER POSITION	A	B	C	D	E	F	G	H	I	J	K	L
1	S	G	S	-	G	-	S	G	S	G	S	G
2	S	S	S	-	S	-	G	S	G	S	G	S
3	G	S	G	-	S	-	S	G	-	-	-	-
4	S	G	-	S	-	G	G	S	-	-	-	-
5	S	S	-	S	-	S	S	G	S	G	-	-
6	G	S	-	G	-	S	G	S	G	S	-	-

S=Signal G=Ground

CONFIGURATION INFORMATION



HDM® is a registered trademark of Teradyne, Inc.

HARD METRIC - 2MM HIGH-SPEED CABLE INTERCONNECT-TO-BACKPLANE SYSTEM

Mechanical

On-Center Spacing 2.0 mm
 Mating Pin Length 4 to 6 mm
 Mating Pin Dimensions 0.35 mm X 0.45 mm
 Insertion Force, Per Contact 0.75 N, max.
 Withdrawal Force, Per Contact 0.15 N, min.
 Normal Force, Per Contact 0.70 N
 Cable Retention Force 22 N
 Durability (Insertions / Withdrawals) 250 cycles

Electrical

Insulation Resistance 100 M Ω , min.
 Dielectric Withstanding Voltage 500 V
 Voltage Rating 250 VAC
 Current Rating, @ 70°C Per Contact 1.0 A
 Contact Resistance 20 m Ω , min.

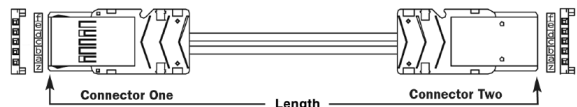
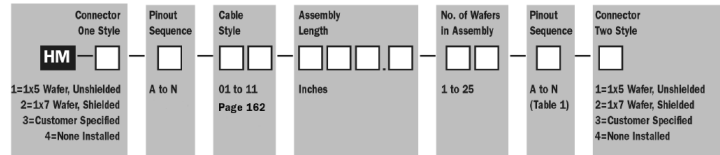

TABLE 1 - AVAILABLE PINOUT SEQUENCES

WAFER POSITION	A	B	C	D	E	F	G	H	J	K	L	M	N
Z	+	+	+	+	+	+	+	+	+	+	+	+	+
A	S	S	-	S	G	S	-	G	-	S	S	S	
B	S	S	-	G	S	G	-	S	-	S	S	S	
C	G	G	G	-	-	-	-	-	-	-	-	S	
D	S	-	S	S	G	-	S	-	G	S	S	S	
E	S	-	S	G	S	-	S	-	S	S	G	S	
F	+	+	+	+	+	+	+	+	+	+	+	+	

S = Signal G = Ground - = No Connection + = With (optional) inter-module shields
 Z and F rows are committed to ground through one or more additional wafer positions
 Note: Z and F do not apply to 1x5 wafers

CONFIGURATION INFORMATION



.100" Pitch

MINIATURE, HIGH-PERFORMANCE INTER-CONNECT-TO-BACKPLANE & JUMPER CABLE ASSEMBLIES

Socket Connectors

1 x 2 1 x 3

50 & 75-ohm Coaxial X X
 100-ohm Shielded Twisted Pair X X
 100-ohm Twin-ax X

Mechanical

On-Center Spacing 0.100"
 Mating Pin Length 0.275", max.
 Insertion Force, Per Contact 0.138 N, max.
 Insertion Force, Per Contact 0.75 N, max.
 Withdrawal Force, Per Contact 0.738 N., min.
 Durability (Insertions / Withdrawals) 250 cycles

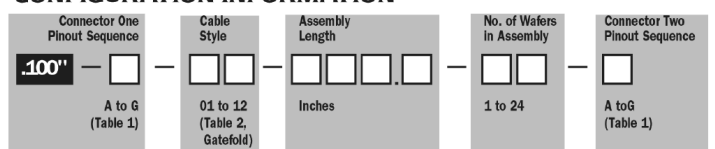

TABLE 1 - .100-INCH SOCKET CONNECTOR PINOUTS

WAFER POSITION	A	B	C	D	E	WAFER POSITION	F	G
1X3	S	G	S	S	-	1X2	S	G
	S	S	-	G	S		G	S
	G	S	G	-	G			





S=Signal G=Ground

CONFIGURATION INFORMATION

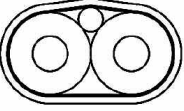
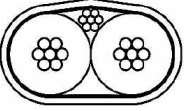
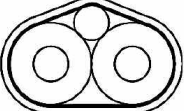
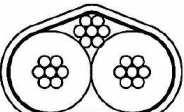

High Density Cable Styles

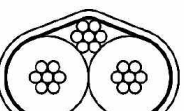
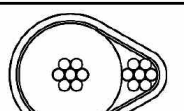
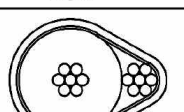
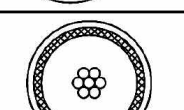
Table A – Standard Cable Styles

Cable Style	Wire Construction	Description	Conductor/Drain AWG	Conductor/Drain Standing	Time Delay ns/ft	Attenuation (db/100ft)	DC Resistance ohms/1,000 ft	Drawing Assembly P/N
01		100 Ω parallel pair	26/28	Solid	1.2	100mHz (nom.) - 11.1 400mHz (nom.) - 22.4	40.0	654-56012-00
02		100 Ω parallel pair	26/30	7 strands	1.2	100mHz (nom.) - 10.0 400mHz (nom.) - 20.3	38.0	654-56006-00
03		100 Ω parallel pair	28/28	Solid	1.2	100mHz (nom.) - 14.1 400mHz (nom.) - 28.3	64.0	654-56008-00
04		100 Ω parallel pair	28/28	7 strands	1.2	100mHz (nom.) - 12.7 400mHz (nom.) - 25.5	60.0	654-56009-00
05		100 Ω parallel pair	30/30	Solid	1.2	100mHz (nom.) - 17.6 400mHz (nom.) - 35.5	102.0	654-56010-00
06		100 Ω parallel pair	30/30	7 strands	1.2	100mHz (nom.) - 15.6 400mHz (nom.) - 31.5	93.0	654-56011-00
07		50 Ω coax	26/26	7 strands	1.2	100mHz (nom.) - 14.0 400mHz (nom.) - 33.0	38.0	654-55035-00
08		50 Ω coax	28/28	7 strands	1.2	100mHz (nom.) - 16.0 400mHz (nom.) - 37.0	60.0	654-55039-00
09		50 Ω coax	26	Solid	1.2	100mHz (nom.) - 8.5 400mHz (nom.) - 17.4	38.0	654-55041-00
10		75 Ω coax	30/30	7 strands	1.2	100mHz (nom.) - 12.5 400mHz (nom.) - 29.5	93.0	654-55037-00
11		Special Customer Specified Cable Style						

Wire constructions utilize an ePTFE dielectric, aluminum-polyester shield with drain or braided shield and FEP Jacket

Semi-Rigid Cable Assemblies

Tensolite's Semi-Rigid cable assemblies are among the highest quality assemblies available today. We custom build these cables to meet your specifications.

Tensolite uses only the highest quality MIL-spec Semi-Rigid cable ranging from .034" to .250" in diameter, and a wide variety of commercial, QPL, and custom connectors including Tensolite's own line of high performance connectors ranging from SMP's, SSMP's, SMA's, smk's, BMA's, TNC's and Type N's.

All soldering is done in a MIL-STD-2000 environment by certified assemblers. We maintain a MIL-I-45208A inspection system with the calibration, sampling procedures and documentation to meet your most demanding requirements.

Applications:

- Military or commercial O.E.M.
- Test equipment
- High shielding environments
- Low cost RF transmission needs

Features:

- Computerized forming equipment
- In-house test capability through 65 GHz
- Tight phase matching capability
- Custom marking
- Rapid delivery

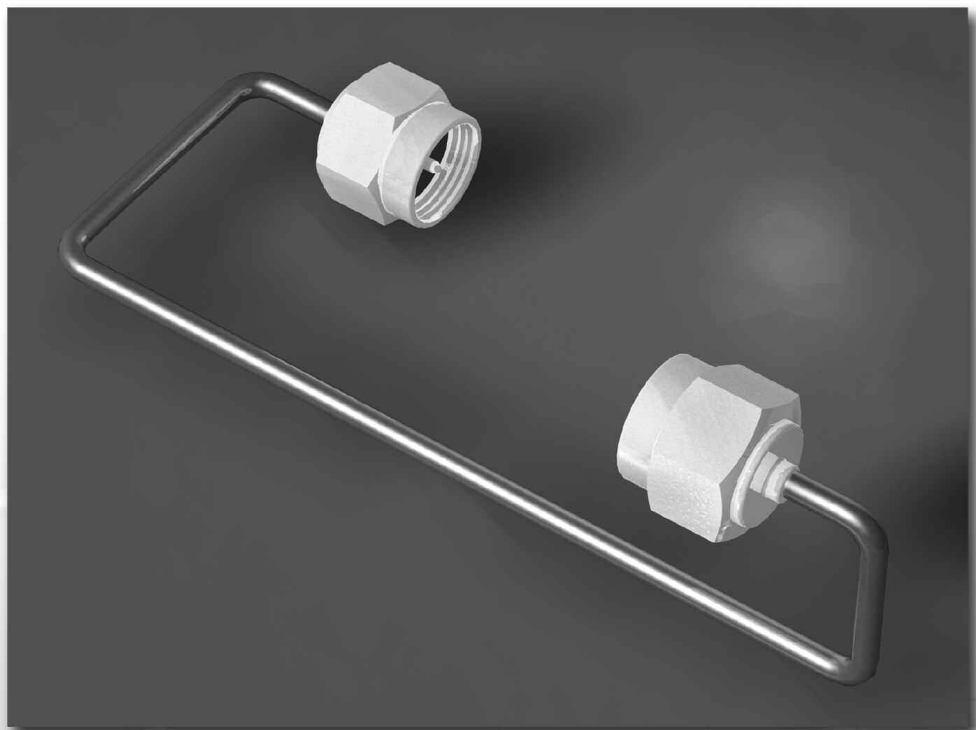
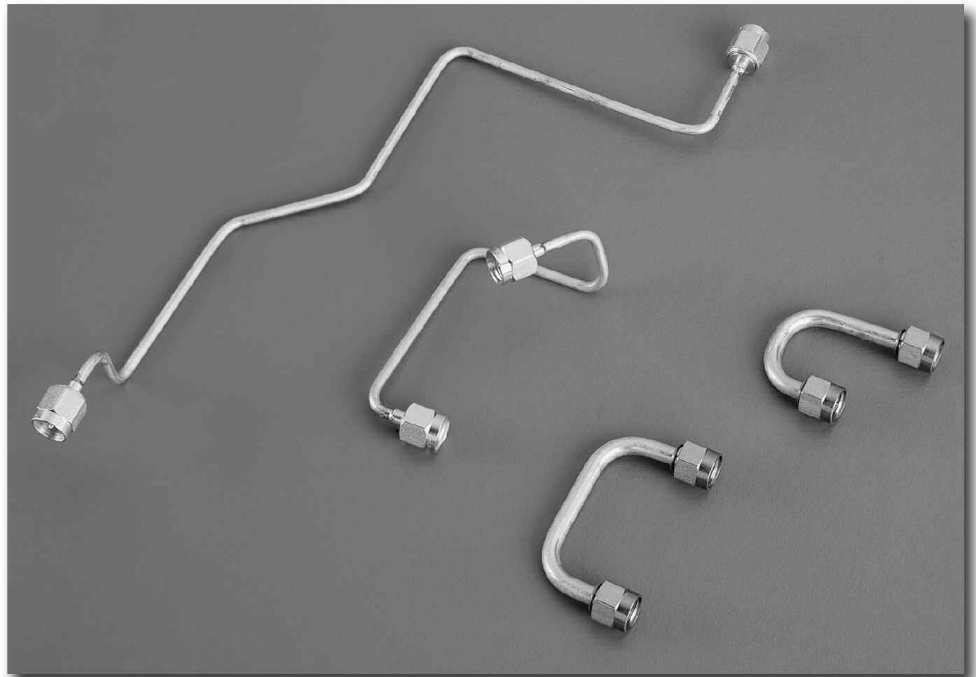

Delay Lines

Passive coax delay lines are an excellent means for providing short delays in RF and Microwave systems. Our engineers will work with you to configure a delay line solution that meets your specific electrical and packaging requirements.

Tensolite uses the highest quality Semi-Rigid and Semi-Flex[®] cable in sizes ranging from .035" to .250" in diameter as well as a variety of flexible coax cables. A wide variety of terminations are available including stripped ends for direct PCB termination.

Applications

- Land mobile radio
- Test equipment
- Cellular base stations

Features:

- Delay and skew tolerances to less than 15 ps
- Excellent phase stability
- Multiple delays in one package
- Low loss and VSWR

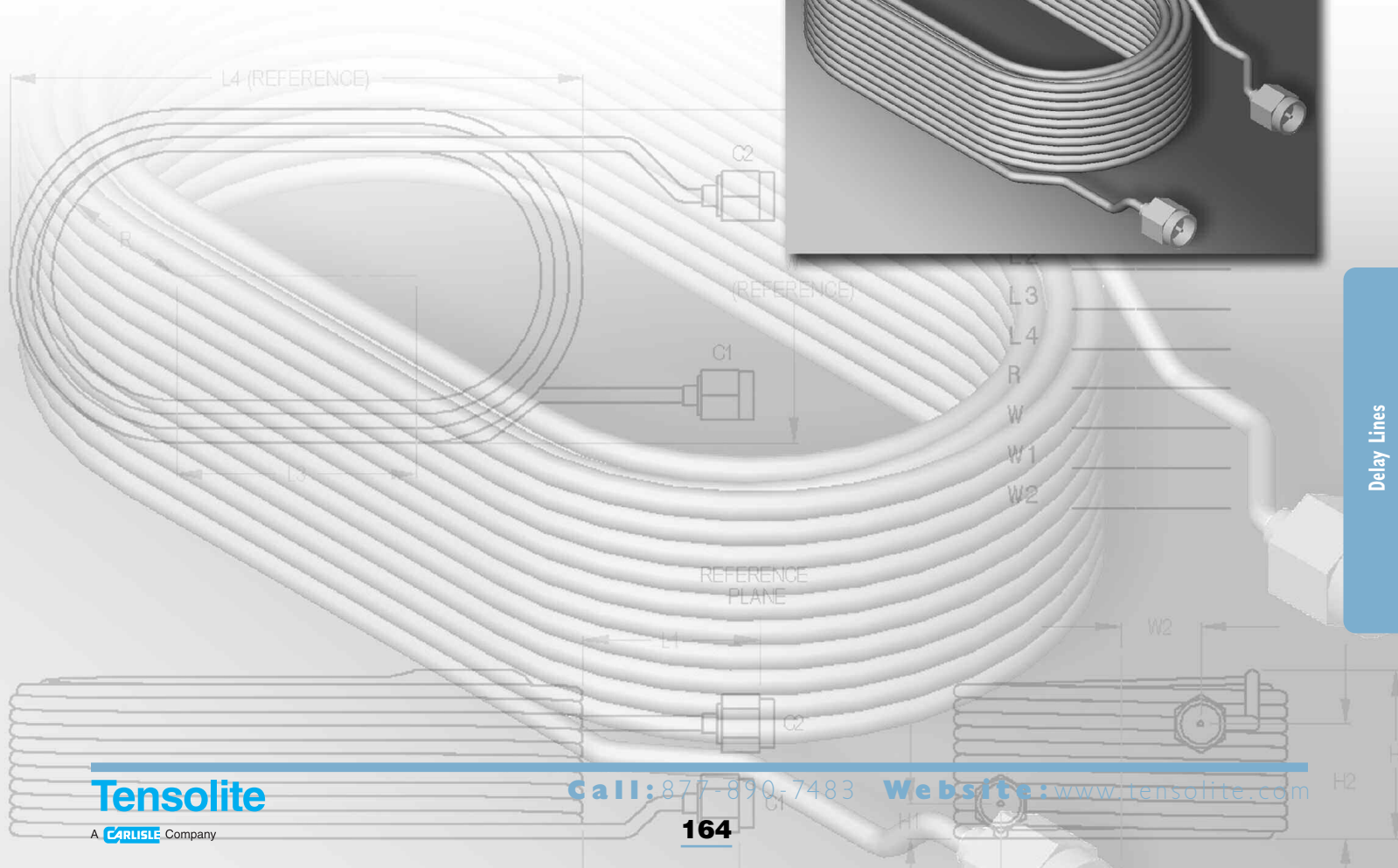
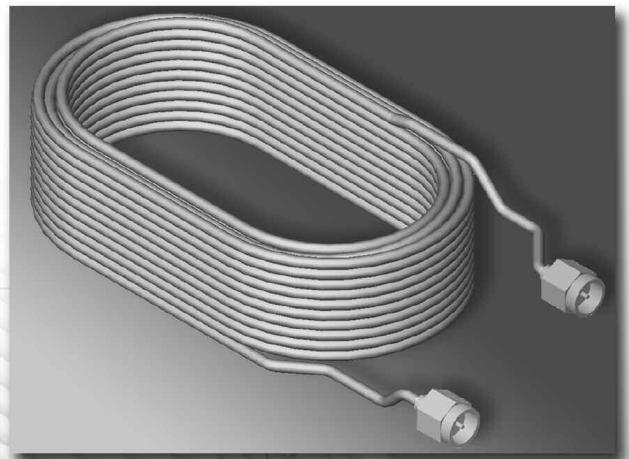
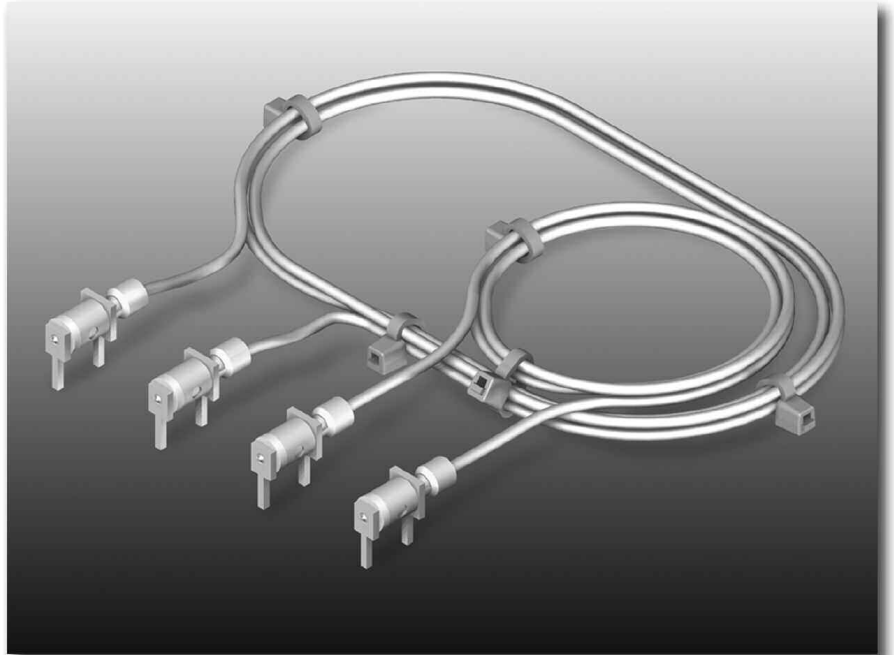

Delay Lines

Peltola Interconnect System

Peltola, a reliable, proven interconnect system

The Tensolite Peltola connector system uses the coaxial cable's center conductor for direct insertion into a receptacle. A press-fit action captures the cable shield, thus eliminating the need for any soldering or special crimping. Each interconnect assembly includes a close tolerance coaxial cable terminated to a male Peltola connector.

The Peltola receptacle is a direct fit replacement for typical SMB-type circuit board mounted receptacles.

The resultant interconnection provides excellent electrical characteristics with a significant cost advantage over typical SMB-type installations.

The Peltola RF interconnect system, designed by Tektronix, Inc., has been proven in the manufacture of its oscilloscopes and other instruments. Tensolite maintains the close-tolerance RF coaxial cable used in PELTOLA assemblies, plus the automated termination equipment for applying the connector.

The PELTOLA assemblies are available in both 50 Ω and 75 Ω impedance versions. PELTOLA cables are available in four standard versions, As shown in Table 1. The PELTOLA connector is available with a machined eyelet that seals the end of the cable, further improving the VSWR of the connection.

There are two PELTOLA receptacle choices, through-hole vertical mount and our NEW SMT right angle receptacle.

PELTOLA to panel-mount BNC is available.

In addition to assemblies with PELTOLA connectors on both ends, Tensolite's production facility can custom manufacture cable assemblies with a PELTOLA connector on one end, and the connector of your choice on the other.

Features:

- Offers a significant price advantage over typical assemblies
- VSWR compares very favorably with typical cable connectors
- Solderless connecting system, with 50 - 75 Ohm options
- SMT Right Angle Receptacle

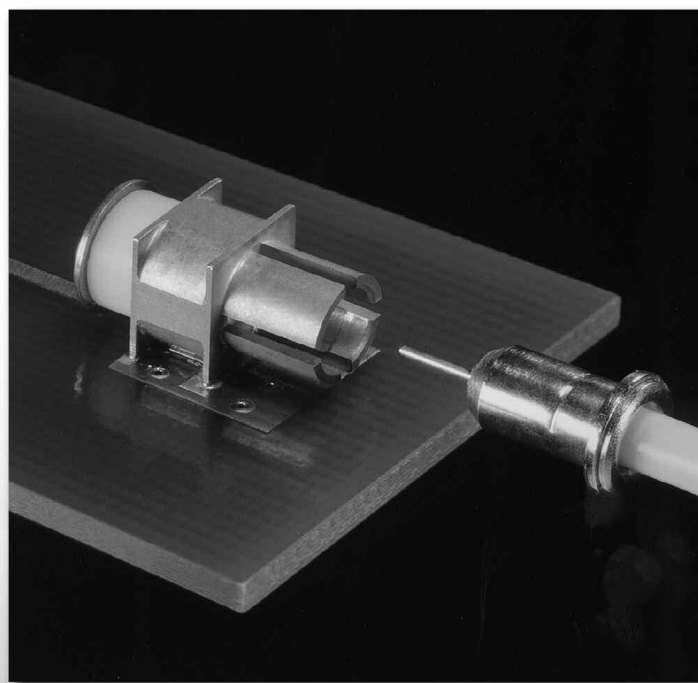
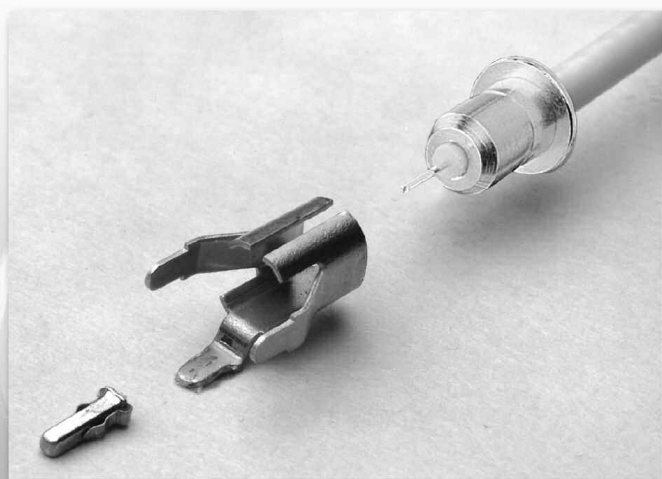

Peltola Interconnect System Data/Specifications

The PELTOLA RF Interconnect System from Tensolite is a proven, low-cost, electrically clean, reliable way to make RF cable connections between circuit boards or to the back side panels.

Electrical

Frequency:	DC - 3 Ghz
Nominal Impedance: Impedance:	50±5 Ohms 75±7.5 Ohms
VSWR Structural Return Loss	1.22:1 Maximum to 3 GHz >20 dB to 3 GHz
TDR	50 Ohm: 2.7 rho-picoseconds 75 Ohm: 2.2 rho-picoseconds

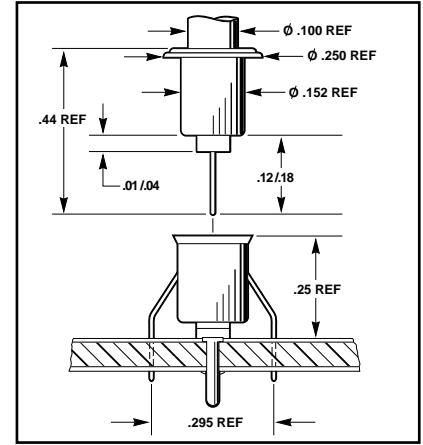

Standard PELTOLA Cable

CABLE PART NO. & CENTER COND.	AWG & O/D (in.)	DIELECTRIC & O/D (Inches)	SHIELD & PCT. of COVERAGE	JACKET & NOM. O/D (INCHES)	NOM. CAP. PF/FT.	IMPEDANCE (Ohms)	CABLE RATING
178-1179-66 Solid, Silver coated, copper covered steel	25 .018	Solid Polyethylene .058	100% Al Polyester 86% TC Braid	Black PP.100	30.8	50±2	-15/+105°C 300V
175-1202-00 Solid, Silver coated, copper covered steel	25 .018	Solid Polyethylene .058	Tin-Coated Copper 88%	PVC .100	30.8	50±1	-15/+80°C 300V
816-0198-00 Solid, Silver coated, copper covered steel	25 .018	FEP PTFE .055	Tin-Coated Copper 88%	FEP PTFE .100	28.4	50±2	15/+150°C 300 V
174-4390-66 Solid, silver coated, Copper Covered Steel	27 .0142	Cellular Polyethylene .061	Tin-coated Copper 88%	PVC .100	17.4	75±3	-15/+80°C 90V

Material

Inner Contact	Brass
Outer Contact	Brass
Receptacle	Brass
SMT	Brass

Finishes

Inner Contact	Nickel/Gold Plate
Outer Contact	Nickel/Gold Plate
Receptacle	Nickel/Gold Plate
Receptacle	Nickel/Gold Plate

Mechanical

Contact Resistance Center Conductor Shield	MIL-STD-202F Method 307 1.5 milliohms 1.5 milliohms
Insertion Force Withdrawal Force	MIL-STD-1344A Method 2013.1 Initial 5 lbs. Initial 3 lbs.

Electrical

VSWR	Dependent upon length of the cable.
Typical VSWR for standard PELTOLA connector with 18" 50 ohm coax	Max 1.4 to 1 at 2 GHz
Typical VSWR for machined PELTOLA connector with 18" 50 ohm coax	Max 1.3 to 1 at 2 GHz

Environmental

Temperature Cycling 55 to +75°C	MIL-STD-810D Method 501.2, 502.2 (combination)
Temperature Storage 85°C/30 day	MIL-STD-202 Method 108A
Humidity Test	MIL-STD-202F Method 106E
Humidity Sulfide	Connectors were subjected to 24 hours of Hydrogen Sulfide at concentration of 5-10 PPM
Vibration 0.05" displacement/ 10 to 55 Hz	MIL-STD-202F Method 201A
Shock 100 gs	MIL-STD-202 Method 202D

Low-Loss Flexible (LLF) Series Cable Summary

Features & Benefits:

- Greater than 90 dB/ft shielding effectiveness
- VSWR less than 1.15:1 to 5GHz and 1.20:1 from 5 to 26GHz, and 1.50:1 from 26 to 40 GHz.
- Excellent attenuation with flex stability
- Superior phase with flex performance
- Excellent vibration performance

Part Numbering System

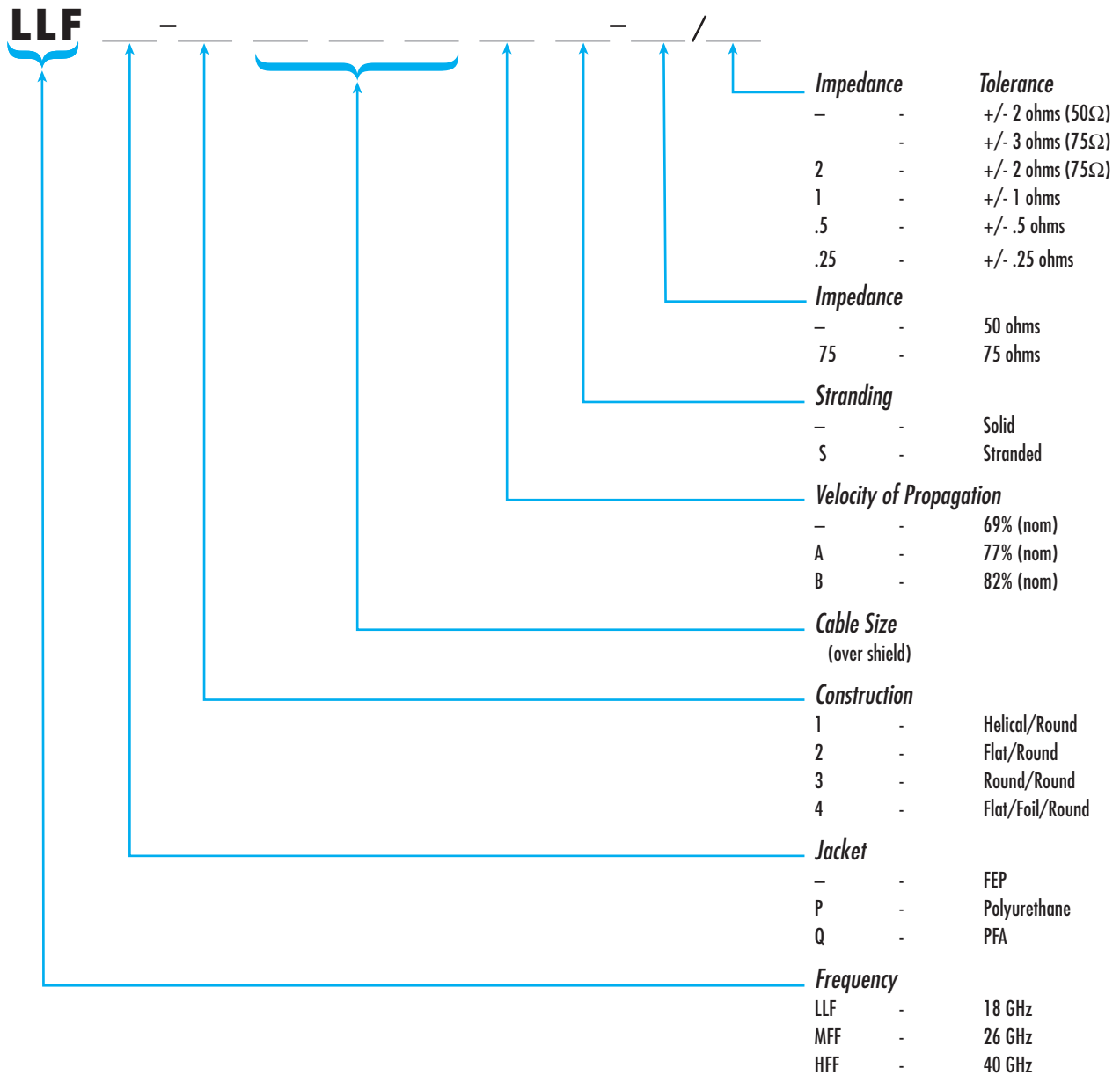

Low-Loss Flexible (LLF) Series Cable

Cable P/N:	LLF-1087	LLF-1141	LLF-1250	LLF-1087-75	LLFP-1087S	LLFP-1141S	LLFP-1250S	HFF-1087
Cable Code:	461	463	465	837	561	563	565	794

MECHANICAL CHARACTERISTICS:

Conductor Construction:	Solid SCCS	Solid SCCS	Solid SC	Solid SCCS	Stranded SCCS	Stranded SC	Stranded SC	Solid SCCS
Conductor Diameter:	0.020"	0.037"	0.064"	0.011"	0.021"	0.038"	0.068"	0.020"
Dielectric Material:	PTFE	PTFE	PTFE	PTFE	PTFE	PTFE	PTFE	PTFE
Dielectric Diameter:	0.064"	0.118"	0.211"	0.065"	0.063"	0.116"	0.211"	0.064"
Shield Type(s):						SC Strip + SC Braid		
Shield Diameter	0.086"	0.142"	0.252"	0.087"	0.086"	0.140"	0.252"	0.086"
Jacket Material:	FEP	FEP	FEP	FEP	Polyurethane	Polyurethane	Polyurethane	FEP
Jacket Diameter:	0.105"	0.163"	0.270"	0.105"	0.115"	0.185"	0.290"	0.105"
Weight(lb/ft):	0.013	0.030	0.090	0.013	0.013	0.029	0.085	0.013
Minimum Bend Radius(inches):	0.5	0.8	1.4	0.5	0.6	0.9	1.5	0.5

SCCS: Silver-coated Copper-covered

ELECTRICAL CHARACTERISTICS:

Impedance(ohms):	50	50	50	75	50	50	50	50
Capacitance(pF/ft):	29	29	29	20	29	29	29	29
Velocity of Propagation(%):	70	70	70	70	70	70	70	70
Max. Operating Voltage(Vrms):	1,500	1,900	3,000	900	1,500	1,900	3,000	1500
Max. Operating Frequency(GHz):	18	18	18	3	18	18	18	40
Shielding Effectiveness(dB/ft):	90	90	90	90	90	90	90	90
Attenuation(dB/100') @ 0.4 GHz:	13.7	7.2	4.2	13.7	14.6	7.7	4.2	13.7
@ 1.0 GHz:	22.2	11.6	7.2	22.2	23.4	12.6	7.6	22.2
@ 3.0 GHz:	38.9	21.2	13.9	38.9	41.6	22.6	15.2	38.9
@ 5.0 GHz:	51.0	28.3	18.9		54.6	30.5	24.8	51.0
@ 10.0 GHz:	74.9	43.0	29.6		79.6	45.8	34.4	74.9
@ 18.0 GHz:	104.3	61.5	44.3		110.6	65.3	47.5	104.3
@ 26.5 GHz:								128.7
@ 40.0 GHz:								176.5

Low-Loss Flexible (LLF) Series Cable

Cable P/N:	LLFQ-1078A	LLFQ-1082AS	LLF-1105BS	LLF-1108BS	LLF-1170BS	LLF-2075AS	LLF-2170BS	LLF-4154	MFF-4182B
Cable Code:	N/A	N/A	N/A	N/A	N/A	N/A	N/A	504	311

MECHANICAL CHARACTERISTICS:

	Solid SCCS	Stranded SC	Stranded SC	Solid SC	Stranded SC	Stranded SC	Stranded SC	Solid SCCS	Stranded SC	Solid SC
Conductor Construction:	Solid SCCS	Stranded SC	Stranded SC	Solid SC	Stranded SC	Stranded SC	Stranded SC	Solid SCCS	Stranded SC	Solid SC
Conductor Diameter:	0.020"	0.024"	0.030"	0.030"	0.054"	0.019"	0.054"	0.037"	0.054"	0.051"
Dielectric Material:	PTFE	PTFE	PTFE	PTFE	PTFE	PTFE	PTFE	PTFE	PTFE	PTFE
Dielectric Diameter:	0.061"	0.066"	0.080"	0.083"	0.142"	0.055"	0.144"	0.118"	0.144"	0.145"
Shield Diameter	0.078"	0.082"	0.105"	0.108"	0.170"	0.074"	0.170"	0.154"	0.170"	0.177"
Jacket Material:	PFA	PFA	FEP	FEP	FEP	FEP	PFA	FEP	FEP	FEP
Jacket Diameter:	0.095"	0.097"	0.118"	0.120"	0.187"	0.086"	0.190"	0.195"	0.190"	0.195"
Weight(lb/ft):	0.010	0.010	0.016	0.016	0.038	0.009	0.035	0.040	0.035	0.037
Minimum Bend Radius(inches):	0.5	0.5	0.6	0.6	0.9	0.4	1.0	1.0	1.0	1.0

ELECTRICAL CHARACTERISTICS:

Impedance(ohms):	50	50	50	50	50	50	50	50	50	50
Capacitance(pF/ft):	27	27	25	25	25	27	25	29	25	25
Velocity of Propagation(%):	77	77	82	82	82	77	82	70	82	82
Max. Operating Voltage(Vrms):	800	800	800	800	1,000	700	1,000	1,400	1,000	1,000
Max. Operating Frequency(GHz):	18	18	18	18	18	18	18	18	18	26.5
Shielding Effectiveness(dB/ft):	90	90	90	90	90	75	75	90	75	4.7
Attenuation(dB/100') @ 0.4 GHz:	12.4	12.8	11.5	8.5	5.3	19.1	6.3	7.5	6.3	7.6
@ 1.0 GHz:	19.5	20.2	18.5	13.1	8.5	32.2	10.3	12.4	10.3	13.4
@ 3.0 GHz:	34.5	35.7	33.5	22.9	15.0	59.0	18.9	22.5	18.9	17.5
@ 5.0 GHz:	45.1	46.6	43.6	29.9	19.6	77.7	25.2	31.0	25.2	26.9
@ 10.0 GHz:										
@ 18.0 GHz:										
@ 26.5 GHz:										

MIL-C-17 Flexible Coaxial Cables

Spec Reference:	M17/28-RG58	M17/60-RG142	M17/75-RG214	M17/84-RG223	M17/83-RG178	M17/111-RG303	M17/113-RG316	M17/127-RG383	M17/128-RG400	M17/152-00001
Cable Code:	115	132	162	174	140	N/A	187	N/A	190	195

MECHANICAL CHARACTERISTICS:

Conductor Construction:	Stranded TC	Solid SCCS	Stranded SC	Solid SC	Stranded SCCS	Solid SCCS	Stranded SCC:	Stranded SC	Stranded SC	Stranded SCCS
Conductor Diameter:	0.036"	0.037"	0.089"	0.035"	0.012"	.037"	0.020"	0.094"	0.038"	0.020"
Dielectric Material:	Polyethylene	PTFE	Polyethylene	Polyethylene	PTFE	PTFE	PTFE	PTFE	PTFE	PTFE
Dielectric Diameter:	0.116"	0.116"	0.285"	0.116"	0.033"	0.116"	0.060"	0.285"	0.118"	0.060"
Shield Type(s):	1 TC Braid	2 SC Braids	2 SC Braids	2 SC Braids	1 SC Braid	1 SC Braid	1 SC Braid	2 SC Braids	2 SC Braids	2 SC Braids
Shield Diameter:	0.138"	0.160"	0.341"	0.160"	0.051"	0.138"	0.078"	0.341"	0.162"	0.096"
Jacket Material:	PVC	FEP	PVC	PVC	FEP	FEP	FEP	FEP	FEP	FEP
Jacket Diameter:	0.195"	0.195"	0.425"	0.212"	0.071"	0.170"	0.098"	0.390"	0.195"	0.114"
Weight(lb/ft):	0.026	0.043	0.134	0.037	0.006	0.030	0.010	0.160	0.042	0.015
Minimum Bend Radius(inches):	1.0	1.0	2.1	1.1	0.4	0.7	0.5	2.0	1.0	0.6

SCCS: Silver-coated Copper-covered Steel; SC: Silver-coated Copper; TC: Tin-coated Copper

ELECTRICAL CHARACTERISTICS:

Impedance(ohms):	50	50	50	50	50	50	50	50	50	50
Capacitance(pF/ft):	31	29	31	31	29	29	29	29	29	29
Velocity of Propagation(%):	66	70	66	66	70	70	70	70	70	70
Max. Operating Voltage(Vrms):	1,400	1,400	3,700	1,400	750	1,400	900	1,875	1,400	900
Max. Operating Frequency(GHz):	1	8	11	12	3	3	3	11	12.4	12.4
Shielding Effectiveness(dB/ft):	40	60	60	60	40	40	40	60	60	60
Attenuation(dB/100') @ 0.4 GHz:	9.7	9.0	5.0	9.3	30.4	8.5	16.1	5.0	8.6	15.9
@ 1.0 GHz:	17.1	15.3	8.7	15.6	49.8	14.1	26.8	15.4	14.5	25.7
@ 3.0 GHz:		29.2	18.8	29.7	93.2	27.0	51.5	17.8	27.1	47.1
@ 5.0 GHz:		40.3	27.7	40.9				25.1	36.8	62.4
@ 10.0 GHz:			48.0	69.3				41.1	56.8	92.4

MIL-C-17 Semi-Rigid Coaxial Cables

MECHANICAL AND ELECTRICAL SPECIFICATIONS OF POPULAR¹ MIL-C-17 SEMI-RIGID CABLES @ AMBIENT

M17# or other#	Nom. O.D. (inches)	Operating Frequency		Power Handling @Max MILSpec Freq. (Watts)	Maximum Attenuation (db/100 FT)						Dielectric Material	Jacket Material	Center Conductor Material	Minimum Inside Bend Radius (inches)	Continuous Working Voltage	Withstanding Voltage (RMS)	Operating Temp. Range(°C)	
		MIL Spec. Max.	90% Cut Off		500 MHz	1 GHz	3 GHz	5 GHz	10 GHz	18 GHz								20 GHz
/151- 00001	.047	20	109	6.5	28	40	70	90	130	180	190	PTFE	COPPER	SPCW*	.125	1000	2000	-40 to +100
696	.047	20	109	6.5	28	40	70	90	130	180	190	PTFE	COPPER	SPC**	.125	1000	2000	-40 to +100
/133- RG405 & /133- 00006 ²	.085	20	61	20	15	22	38	50	80	122	130	PTFE	COPPER	SPCW*	.125	1500	5000	-40 to +125
/133- 00002 & /133- 00008 ²	.085	20	61	20	15	22	38	50	80	122	130	PTFE	COPPER	SPC**	.125	1500	5000	-40 to +125
/130- RG402 & /130 00004 ²	.141	20	34	70	8	12	21	29	45	62	70	PTFE	COPPER	SPCW*	.250	1900	5000	-40 to +125
675	.141	20	34	70	8	12	21	29	45	62	70	PTFE	COPPER	SPC**	.250	1900	5000	-40 to +125
/129- RG401	.250	18	19	200	5.1	7.5	11	16	33	48		PTFE	COPPER	SPC**	.375	3000	7500	-40 to +90

Follow these guidelines for the best performing lowest cost and shortest lead time assemblies:

A. DIMENSIONS

Drawing layout should be in absolute XYZ format with one connector interface reference plane the 0,0 point from which all subsequent measurements are made. This eliminates a build up of tolerances.

E. CONNECTORS

Specify SMA plugs whenever possible. Tensolite's SMA's easily out perform most SMA's available today. Avoid unusual connector designs as well as unpopular items such as bulkheads or panel mounts. Allow "equivalents" to increase the probability of availability or lower costs.

¹Other cable diameters and material plating options exist. Consult Tensolite for more information.
²Soft annealed copper jacket.

B. TOLERANCES

0-4" lengths: ± 0.03
4-12" lengths: ± 0.05
>12" lengths: $\pm (0.05) \times (\text{length})$
Example: A cable with two bends and three legs 3", 5", and 10" long would have leg tolerances of $\pm .03"$, $\pm .05"$, and $\pm .09"$ respectively. The furthest end of the 10" leg length is 18" from the 0,0,0 point.

F. CABLE

Semi-rigid cable is available in standard as well as soft copper outer jackets. One may choose from a wide assortment of jacket and center conductor platings. A selection of the more popular options are listed above. If no requirement other than O.D. is specified, Tensolite uses soft jacketed, steel center conductor cable.

C. BENDS

For best performance do not exceed the minimum inside bend radii specified in the table above. To allow optimum use of computerized forming equipment and eliminate tooling:
1. Use the same radius dimension within a given assembly.
2. Do not specify a radius greater than 0.5".
3. Allow a minimum .150" of straight cable between bends.

G. DRAWINGS

Ensure drawings are complete with all dimensions, views, materials, tolerances, proper scale, electrical and environmental requirements. Obtain from Tensolite a special part number uniquely assigned to your print before releasing the final document.

D. MARKERS

Use commonly available MIL spec or commercial shrink marker material in high contrast black with white characters, two lines/marker maximum. Wrap markers are less costly on small quantity, quick delivery orders. Avoid serialization and one-of-a-kind markers.

H. PACKAGING

Unless otherwise specified cables are individually sealed in plastic bags, wrapped in wadding and sealed in heavy duty outer containers to prevent damage during shipping.

Remember, these are just guidelines. If you must exceed them consult Tensolite for more information.

*Silver plated copper clad steel.
**Silver plated copper.

Acculite UT (Ultra Thin)

Miniaturized, lightweight PTFE insulated lead wire

Tensolite ACCULITE - UT wire is a series of lightweight, smaller diameter lead wire for applications requiring thinner wall thickness' and smaller conductor sizes. Standard wall thickness' range from .0015 inches to .0040 inches.

Typical Applications for ACCULITE - UT are:

- * Subminiature Thermocouple leads
- * Test Equipment Wiring
- * Miniature slip ring and gyroscope
- * Miniature brush block assemblies
- * Strain gauge and transducer leads
- * Medical Equipment
- * Tone arm and hearing aid wire
- * Micro component interconnect wiring
- * Radio and Television circuitry
- * Telemetry equipment
- * Aerospace and Missile instrumentation

TENSOLITE PRODUCT CODE	AWG Silver Plated Copper	Dielectric Material	Nominal wall Thickness	Finished Diameter Min/Max	Max D.C. Resistance Ohms/ 1000ft. @ 20 °C	Nominal Weight/ 1000 ft
S26UT	26 (1/26)	PTFE	.0040	.022 / .025	42.1	1.000
S28UT	28 (1/28)	PTFE	.0035	.018 / .021	66.4	0.650
S736UT	28 (7/36)	PTFE	.0040	.021 / .025	62.0	0.768
S30UT	30 (1/30)	PTFE	.0030	.015 / .017	102.0	0.430
S738UT	30 (7/38)	PTFE	.0040	.018 / .022	97.8	0.573
S32UT	32 (1/32)	PTFE	.0030	.013 / .015	166.0	0.290
S740UT	32 (7/40)	PTFE	.0040	.015 / .020	166.0	0.379
S34UT	34 (1/34)	PTFE	.0025	.010 / .012	270.0	0.190
S742UT	34 (7/42)	PTFE	.0035	.014 / .016	258.0	0.261
S36UT *	36 (1/36)	PTFE	.0015	.007 / .009	850.0	0.105
S744UT *	36 (7/44)	PTFE	.0035	.012 / .015	630.0	0.200

*Manufactured with silver-plated copper alloy conductor

UT Performance:

Operating Voltage: 100 Vrms, 60 Hz, or 300 Vdc, Max.

Operating Temperature: -90 °C to 200 °C

Colors Available: Black, Brown, Red, Orange, Yellow, Green, Blue, Violet, Gray, White

***NOTE: ACCULITE IS A TRADE NAME OF THE TENSOLITE COMPANY.**

X-ON Electronics

Largest Supplier of Electrical and Electronic Components

Click to view similar products for [Ethernet Cables / Networking Cables](#) *category:*

Click to view products by [Carlisle Interconnect Technologies](#) *manufacturer:*

Other Similar products are found below :

[0152660053](#) [603020002](#) [73-7797-25](#) [73-8890-10](#) [73-8890-14](#) [73-8891-14](#) [73-8891-25](#) [73-8892-50](#) [73-8894-10](#) [73-8894-3](#) [73-8895-14](#) [73-8896-7](#) [MCJB2-10P6Q7-120](#) [84909-0204](#) [9QA0-111-12-3.00](#) [1200650742](#) [1200700174](#) [1200860368](#) [1200650013](#) [1201080008](#) [1-21919-1](#) [1300500373](#) [1300101844](#) [1300101845](#) [130050-0004](#) [1300500014](#) [1410147](#) [E16A06002M030](#) [E200102-009-S1](#) [MT14-187L](#) [17-103530](#) [NK5EPC18RDY](#) [NK5EPC18VLY](#) [NK5EPC18YLY](#) [NK5EPC1GRY](#) [NK5EPC30BLY](#) [NK5EPC30VLY](#) [NK5EPC30YLY](#) [NK5EPC4Y](#) [NK5EPC6YLY](#) [NK5EPC8BLY](#) [NK5EPC9YLY](#) [NK6PC30BUY](#) [NK6PC30GRY](#) [NK6PC30RDY](#) [NK6PC30Y](#) [NK6PC30YLY](#) [1969343-6](#) [C501100010](#) [C501106002](#)