

# Monitoring Relays True RMS AC Current Transformer Types A 82-10, A 82-20, A 82-30

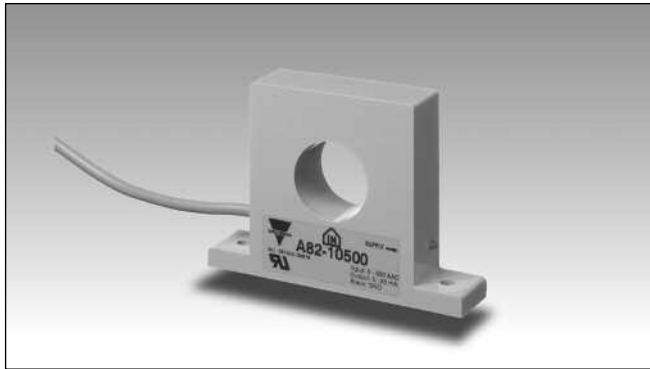

- 5 types of input:
  - 0 - 25 AAC
  - 0 - 50 AAC
  - 0 - 100 AAC
  - 0 - 250 AAC
  - 0 - 500 AAC
- Output:
  - A 82-10: 0 - 20 mADC (source)
  - A 82-20: 4 - 20 mADC (sink)
  - A 82-30: 0 - 10 VDC
- Easy interface to PLC or setpoint relays

## Product Description

True RMS AC current metering transformer for 25, 50, 100, 250 or 500 AAC. Output current in accordance with IEC 60381-1 (A 82-10, A 82-20) or output voltage in accordance with IEC 60381-2 (A 82-30).  
A 82-10 and A 82-20 can be used with relays DIB01, PIB01, DIC01 or PIC01.

A 82-30 can be used with DUB01, PUB01, DUB71, DUC01 or PUC01.  
All units can be directly connected to a PLC. Power supply ON is indicated by a green LED on the side of the housing.

## Ordering Key

**A 82-10 50**

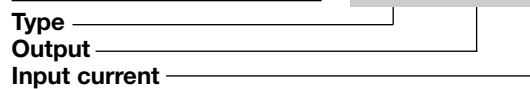

## Type Selection

Input current	Output	Type no.
25 AAC	0 - 20 mA	A 82-10 25
50 AAC	0 - 20 mA	A 82-10 50
100 AAC	0 - 20 mA	A 82-10 100
250 AAC	0 - 20 mA	A 82-10 250
500 AAC	0 - 20 mA	A 82-10 500
25 AAC	4 - 20 mA	A 82-20 25
50 AAC	4 - 20 mA	A 82-20 50
100 AAC	4 - 20 mA	A 82-20 100
250 AAC	4 - 20 mA	A 82-20 250
500 AAC	4 - 20 mA	A 82-20 500
25 AAC	0 - 10 V	A 82-30 25
50 AAC	0 - 10 V	A 82-30 50
100 AAC	0 - 10 V	A 82-30 100
250 AAC	0 - 10 V	A 82-30 250
500 AAC	0 - 10 V	A 82-30 500

## Input Specifications

	A 82-10/20/30 25	A 82-10/20/30 50	A 82-10/20/30 100	A 82-10/20/30 250	A 82-10/20/30 500
<b>Current range</b>	0 - 25 AAC	0 - 50 AAC	0 - 100 AAC	0 - 250 AAC	0 - 500 AAC
<b>Max. current</b> (continuously)	600 AAC	600 AAC	600 AAC	600 AAC	600 AAC
<b>Max. overload current</b> (t = 30 s)	3000 AAC	3000 AAC	3000 AAC	3000 AAC	3000 AAC
<b>Rated insulation voltage</b> Input - output	1000 VAC <sub>rms</sub>	1000 VAC <sub>rms</sub>	1000 VAC <sub>rms</sub>	1000 VAC <sub>rms</sub>	1000 VAC <sub>rms</sub>
<b>Overvoltage category</b>	IV (IEC 60664)	IV (IEC 60664)	IV (IEC 60664)	IV (IEC 60664)	IV (IEC 60664)
<b>Dielectric strength</b> Dielectric voltage Rated impulse withstand volt.	6 kVAC <sub>rms</sub> 12 kV (1.2/50 μs)	6 kVAC <sub>rms</sub> 12 kV (1.2/50 μs)	6 kVAC <sub>rms</sub> 12 kV (1.2/50 μs)	6 kVAC <sub>rms</sub> 12 kV (1.2/50 μs)	6 kVAC <sub>rms</sub> 12 kV (1.2/50 μs)



## Output Specifications

<b>Rated insulation voltage (cable)</b>	250 VAC <sub>rms</sub>	
<b>Output</b>	A 82-10	0 - 20 mADC
	A 82-20	4 - 20 mADC
	A 82-30	0 - 10 VDC
<b>Power supply (loop voltage)</b>	10 - 40 VDC	
	A 82-10, A 82-20	10 - 40 VDC
	A 82-30	18 - 40 VDC
<b>Tolerance of output current @ 50 Hz</b>	A 82-10	±2%
	A 82-20	± 2%
<b>Tolerance of output voltage @ 50 Hz</b>	A 82-30	±2%
<b>Temperature variation</b>	±400 ppm/°C	
<b>Frequency range</b>	40 Hz - 1 kHz	
<b>Frequency variation</b>	10 ppm/Hz	
<b>Maximum output current</b>	30 mADC	
	A 82-10, A 82-20	
<b>Maximum output voltage</b>	15 VDC	
	A 82-30	
<b>Minimum output load</b>	10 kΩ	
	A 82-30	

## General Specifications

<b>Power ON delay</b>	< 2 s	
<b>Reaction time</b>	T < 200 ms	
<b>Indication for Power supply ON</b>	LED, green	
<b>Environment</b>	IP 40	
	Degree of protection	
	Pollution degree 3 (IEC 60664)	
	Operating temperature -20° to 50°C (-4° to +122 °F)	
<b>Housing</b>	95 x 67.5 x 20 mm	
	Dimensions	
	Material ABS	
<b>Weight</b>	A 82-10, A 82-30	300 g
	A 82-20	270 g
<b>Connection cable</b>	2 m, 3 x 0.25 mm <sup>2</sup>	
	A 82-10, A 82-30	
	A 82-20	2 m, 2 x 0.25 mm <sup>2</sup>
<b>Approval</b>	UL	
<b>CE marking</b>	Yes	
<b>EMC</b>	Electromagnetic Compatibility	
	Immunity According to EN 61000-6-1 (tolerance of output current/voltage: ± 2%)	
	According to EN 61000-6-2 (tolerance of output current/voltage: ± 5%)	
	Emission According to EN 61000-6-3	

## Mode of Operation

A 82-10 and A 82-20 are true RMS current metering transformers with standard source/sink output 0-20 mA / 4-20 mA, whereas A 82-30 is a metering transformer with 0-10 VDC output voltage. This makes them very useful as an AC current interface to

a PLC with mADC or VDC input. Used with relays DIB01, PIB01, DIC01, PIC01 (A 82-10, A 82-20) or DUB01, PUB01, DUB71, DUC01, PUC01 (A 82-30), one or more setpoints can monitor the current and signal alarm.

The metered conductor is drawn through the central hole of the current metering transformer. It is possible to meter currents below the nominal range by drawing the conductor through the hole several times. If the conductor is drawn through

the central hole e.g. 5 times, the transformer will register 50 A when the current in the conductor is 10 A.

## Input/Output Curve

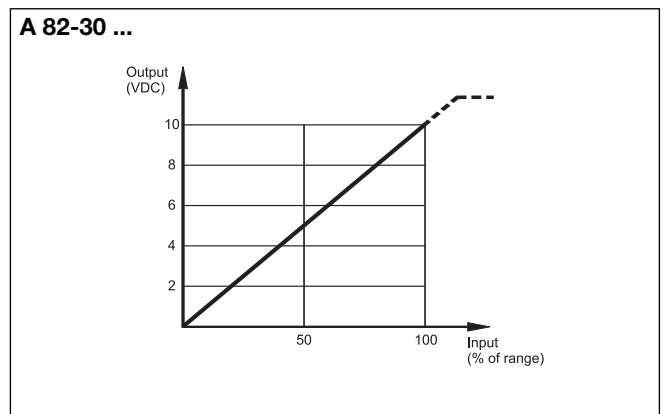
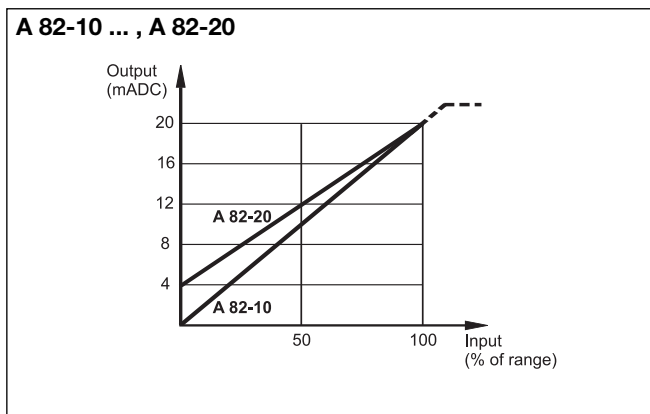

## Resistance/Voltage Curve

**A 82-10 ... , A 82-20**  
 (max. load resistance vs Power supply - Loop voltage)

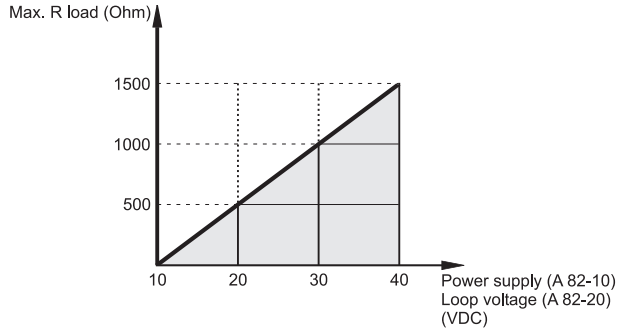

## Wiring Diagrams

**A 82-10 ... (source)**

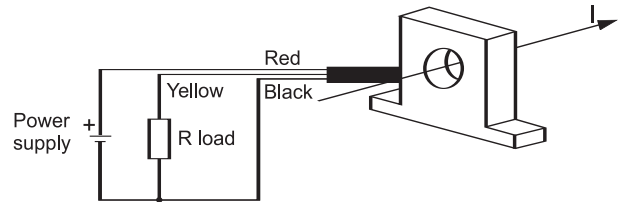

## Wiring Diagrams (cont.)

**A 82-20 ... (sink)**

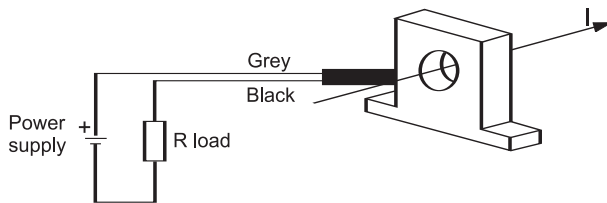

**A 82-30 ...**

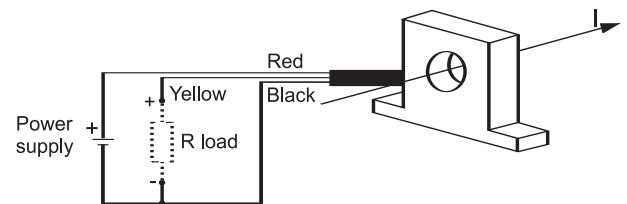

## Dimensions

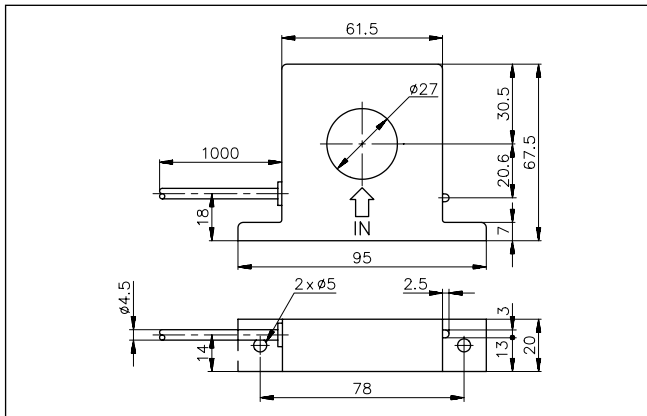

## X-ON Electronics

Largest Supplier of Electrical and Electronic Components

*Click to view similar products for [Current Transformers](#) category:*

*Click to view products by [Carlo Gavazzi](#) manufacturer:*

Other Similar products are found below :

[L595100](#) [ACST-260](#) [AKW4802C](#) [MP3500](#) [L595050](#) [E54CT1L](#) [CTD-KIT](#) [44021](#) [PA3828NL](#) [CT16-1-50A/50MA](#) [SPCT 100/60 1200/5A](#)  
[VA 15 CL 0.5](#) [SPCT 100/60 1000/5A VA 15 CL 0.5](#) [SPCT 100/60 600/5 A VA 7.5 CL 1](#) [SPCT 100/60 600/5 A VA 5 CL 0.5](#) [SPCT 100/60](#)  
[800/5 A VA 10 CL 0.5](#) [SPCT 140/100 1200/5A VA 15 CL 0.5](#) [SPCT 140/100 1250/5A VA 15 CL 0.5](#) [SPCT 140/100 1500/5A VA 15 CL 0.5](#)  
[SPCT 140/100 1600/5A VA 15 CL 0.5](#) [SPCT 140/100 1000/5A VA 15 CL 0.5](#) [SPCT 140/100 2500/5A VA 15 CL 0.5](#) [SPCT 140/100 2000/5A](#)  
[VA 15 CL 0.5](#) [SPCT 140/100 3000/5A VA 15 CL 0.5](#) [SPCT 140/100 800/5A VA 15 CL 0.5](#) [SPCT 62/30 50/5A VA1 CL 3](#) [SPCT 62/30 60/5A](#)  
[VA1 CL 3](#) [SPCT 62/30 75/5A VA1 CL 3](#) [SPCT 62/30 75/5A VA3 CL 3](#) [SPCT 62/40 100/5 A VA 1 CL 1](#) [SPCT 62/40 125/5 A VA 1 CL 1](#)  
[SPCT 62/40 150/5 A VA 3 CL 1](#) [SPCT 62/40 160/5 A VA 1.5 CL 1](#) [SPCT 62/40 200/5 A VA 3 CL 1](#) [SPCT 62/40 250/5 A VA 2.5 CL 0.5](#)  
[SPCT 62/40 250/5 A VA 3 CL 1](#) [SPCT 62/40 300/5 A VA 3 CL 0.5](#) [SPCT 62/40 400/5 A VA 3.75 CL 0.5](#) [HPT205NBJ-1](#) [HCT204KFH](#)  
[HCT20K-QD](#) [HPT205A/F](#) [HCT-1\(80\)AH](#) [HCT916HBT-1W](#) [CT100A](#) [7251](#) [CST-1025](#) [TEZ25/D25/15V](#) [TEZ2/D110/12V](#) [TEZ30/D230/12-](#)  
[12V](#) [TEZ30/D230/15V](#)