

Energy Management Modular Smart Power Quality Analyzer Type WM5-96



- MODBUS RTU and TCP, JBUS protocol, iFIX SCADA compatibility
- Real time clock function (without back-up)
- Up to 12 optional digital inputs (sync function, remote digital input control)
- Up to 16 optional digital outputs (pulse, alarm, remote control)
- 16 freely configurable alarms with OR/AND logic linkable with up to 4 relay outputs and up to 16 open collector outputs
- Up to 8 optional analogue outputs (+20mA, +10VDC, +/- 5mA)
- Universal power supply: 18-60VAC/VDC, 90-260 VAC/VDC
- Front protection degree: IP 65, NEMA4x, NEMA12

- Class 0.2 (current/voltage)
- ARM® powered
- Back-lighted graph display (128x64 dots)
- Bargraph indication of instantaneous power (kW sys)
- Front size: 96x96 mm
- Measurement of single phase and system instantaneous variables: W, var, VA, PF, VLL, VLN, A_L, A_n, Hz, THD, ASY VLL, ASY VLN (for all measurements max, min, dmd/AVG and max dmd/AVG values)
- Measured energies (imported/exported): kWh and kvarh
- Current and voltage inputs with autoranging capability
- 4x4 DGT instantaneous variable read-out
- 4x9 DGT total energies read-out
- 4x9 DGT partial energies read-out
- Energy measurements according to ANSI C12.20, CA 0.5, EN62053-22 CL 0.5S and ANSI C12.1, EN62053-23 CL 2
- 4 total 3-phase, 48 partial 3-phase and 12 total single phase independent energy meters to be used as single, dual, multi-time tariff management
- Display refresh rate: 10 time / sec
- Harmonic distortion analysis (FFT) up to the 63rd harmonic with graphic and numeric indication (current and voltage)
- Harmonics source detection
- Data stamping of up to 10,000 events: alarm, min, max, digital input status, digital output status as remote control, resets
- 4 independent communication ports: optical front communication port (ANSI C12.18) optional RS 422/485 serial port, optional RS232 + real time clock function, optional Ethernet port

Product Description

3-phase utility grade power quality analyzer. Particularly recommended for the measurement of the main electrical variables. Housing for panel mounting, with optical communication

port (according to the ANSI standards), RS485/RS232 or Ethernet communication ports, pulse and alarm outputs. Parameters programming and data reading by means of Wm5Soft.

How to order

WM5-96 see next page

How to order

Wm5Soft

Parameters programming and data reading by means of Wm5Soft.

Modules Combination

Description	Part N.	Slot A	Slot B	Slot C	Slot D	Slot E
WM5-96 base with ANSI local port	AD2001					
WM5-96 base without local port	AD2000					
Power supply (18-60VAC/DC)	AP1021					
Power supply (90-260VAC/DC)	AP1020					
Measuring input (AV5: 400/690VL-L)	AQ2030					
Measuring input (AV6: 120/208VL-L)	AQ2031					
RS485 port (9 600 bps)	AR1034		1-port			
RS485 port (115,200 bps)	AR2040		1-port			
Ethernet/Internet port	AR1061	1-port				
Analogue output (20mA DC)	AO2050	2-out	2-out			
Analogue output (10V DC)	AO2051	2-out	2-out	2-out	2-out	
Analogue output (+/-5mA DC)	AO2052	2-out	2-out	2-out	2-out	
Relay output	AO1058	1-out	1-out	1-out	1-out	
Relay output	AO1035			2-out	2-out	
Open collector output	AO1059	1-out	1-out	1-out	1-out	
Open collector output	AO1036	2-out	2-out	2-out	2-out	
Open collector output	AO1037	4-out	4-out	4-out	4-out	
Digital inputs	AQ1038	3-in	3-in	3-in	3-in	
Digital inputs + Aux	AQ1042	3-in	3-in	3-in	3-in	
RS232 port + RTC (9 600 bps)	AR1039					1-port



How to order WM5 96

Minimum modules for a basic unit on grey background
 Ordering key (fully assembled instrument):

WM5 96 AV53 H XX XX XX XX XX

Description	Ch	Part No.	Legend
Model			
WM5-96 with optical port ANSI C12.18 type		AD2001	WM5 96
WM5-96 without optical port		AD2000	WM5 96
Range code+sys (meas. inputs)			
400/690VL-L 1/5A (10A)		AQ2030	AV5.3
120/208VL-L 1/5A (10A)		AQ2031	AV6.3
Power supply			
18-60VAC/DC power supply		AP1021	L
90-260VAC/DC power supply		AP1020	H
SLOT A			
None			XX
Ethernet/Internet port	1	AR1061	E2
Digital inputs	3	AQ1038	D1
Digital inputs + aux	3	AQ1042	D2
Open collector output	4	AO1037	O4
Open collector output	2	AO1036	O2
Open collector output	1	AO1059	O1
Relay output	1	AO1058	R1
Analogue output 20mADC	2	AO2050	B1
Analogue output 10VDC	2	AO2051	W1
Analogue output +/-5mA	2	AO2052	B2
SLOT B			
None			XX
Digital inputs	3	AQ1038	D1
Digital inputs + aux	3	AQ1042	D2
Open collector output	4	AO1037	O4
Open collector output	2	AO1036	O2
Open collector output	1	AO1059	O1
Relay output	1	AO1058	R1
Analogue output 20mADC	2	AO2050	B1
Analogue output 10VDC	2	AO2051	W1
Analogue output +/-5mA	2	AO2052	B2
RS485 9600bps	1	AR1034	S1
RS485 115200bps	1	AR2040	S2
SLOT C			
None			XX
Digital inputs	3	AQ1038	D1
Digital inputs + aux	3	AQ1042	D2
Open collector output	4	AO1037	O4
Open collector output	2	AO1036	O2
Open collector output	1	AO1059	O1
Relay output	1	AO1058	R1
Relay output	2	AO1035	R2
Analogue output 10VDC	2	AO2051	W1
Analogue output +/-5mA	2	AO2052	B2
SLOT D			
None			XX
Digital inputs	3	AQ1038	D1
Digital inputs + aux	3	AQ1042	D2
Open collector output	4	AO1037	O4
Open collector output	2	AO1036	O2
Open collector output	1	AO1059	O1
Relay output	1	AO1058	R1
Relay output	2	AO1035	R2
Analogue output 10VDC	2	AO2051	W1
Analogue output +/-5mA	2	AO2052	B2
OPTIONS SLOT E			
Utility grade with optical port RS232 + RTC (utility grade)	1	AR1039	XX SX
"Type approval" Canada for further "Revenue approval" process (*)			XU
RS232+RTC + "XU" option	1	AR1039	SU
Utility grade without optical port			YY
RS232 + RTC (utility grade) without optical port	1	AR1039	SY

Example of which modules to order for:
WM5-96 AV53 H B1 S1 R2 O2 SX

Bill of material	Ordering No.
WM5 96	AD2001
AV53 measuring inputs (400/690VL-L)	AQ2030
90-260VAC/DC power supply	AP1020
Analogue output 20mA (2 channels)	AO2050
RS485 serial port 9600 bps	AR1034
Relay output (2 channels)	AO1035
Open collector (2 channels)	AO1036
RS232 port+RTC	AR1039

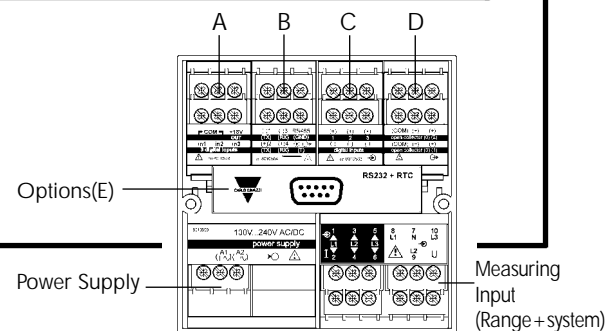

(*) Available only for the assembled meters having the 2 possible minimum base configuration, respectively made up of:
 1. display module + power supply module H + AV5 3 special mode
 2. display module + power supply module H + AV6 3 special mode.

Input specifications

Number of analogue inputs		Energies (@ 20°C ± 5°C, R.H. ≤ 75%)	Active: class 0.5 according to EN62053-22, ANSI C12.20 Reactive: class 2 according to EN62053-23, ANSI C12.1 In: 5A, I _{max} : 10A 0.1In: 500mA, Start-up current: 5mA Un: 400/690V _{L-L} (AV5) Un: 120/208V _{L-L} (AV6) 1% FS (FS: 100%) phase: ±2°; I _{min} : 5mA _{RMS} ; I _{max} : 15A _p ; U _{min} : 30V _{RMS} ; U _{max} : 500V _p
Current	1 (1-phase; system code: 3) 3 (3-phase; system code: 3)		
Voltage	1 (1-phase; system code: 3) 4 (3-phase; system code: 3)		
Digital inputs (on request)	Up to 12	Harmonic distortion (@ 20°C ± 5°C, R.H. ≤ 75%)	
AQ1038	No. of inputs: 3 (voltage-free)		
Purpose	"dmd" measurements synchronisation. Tariff selection: energy. Contact status reading. Clock synchronisation.		
Contact measuring current	<8mA/ 17.5 to 25VDC		
AQ1042	Number of inputs: 3 + excitation output		
Purpose	"dmd" measurements synchronisation. Tariff selection: energy. Contact status reading. Clock synchronisation.		
Excitation output	16V<+Aux<24VDC Max 15mA		
Contact measuring current	15mA		
Common characteristics			
Close contact resistance	Max 1kΩ		
Open contact resistance	Min 100kΩ		
Insulation	see "Insulation between inputs and outputs" table		
Accuracy (display, RS232, RS485)	In: 5A, I _{f.s.} : 10A Un: see voltage ranges below		
Current (A _{L1} , A _{L2} , A _{L3}) (@20°C ± 5°C, R.H. ≤ 75%)	from 0.05In to I _{max} : ±(0.2%RDG+2DGT) from 0.01In to 0.05In: ±(0.5%RDG+2DGT)		
Current (A _n)	±0.5% RDG (0.2 to 2 In) @ 40 to 100 Hz		
Voltage (@20°C±5°C,R.H.≤75%) range AV5:	400/690V _{L-L} AC V _{L-N} : 185 V to 460 V V _{L-L} : 320 V to 800 V ±(0.2%RDG+1DGT)		
range AV6:	120/208V _{L-L} AC V _{L-N} : 45 V to 145 V V _{L-L} : 78 V to 250 V ±(0.2%RDG+1DGT) Includes also: frequency, power supply and output load influences		
Frequency	±0.1% RDG (40 to 440 Hz)		
Active power and apparent power (@ 20°C ± 5°C, R.H. ≤ 75%)	0.05In to I _{max} , PF 1: ±(0.5%RDG+1DGT) 0.01In to 0.05In, PF 1: ±(1%RDG+1DGT) 0.1In to I _{max} , PF0.5L, PF 0.8C: ±(0.6%RDG+1DGT) 0.02In to 0.1In,PF0.5L, PF 0.8C: ±(1%RDG+1DGT)		
Reactive power (@ 20°C ± 5°C, R.H. ≤ 75%)	0.1In to I _{max} , senφ 0.5L/C: ±(2%RDG+1DGT) 0.05In to 0.1In, senφ 0.5L/C: ±(2.5%RDG+1DGT) 0.05In to I _{max} , senφ 1: ±(2%RDG+1DGT) 0.02In to 0.05In, senφ 1: ±(2.5%RDG+1DGT)		
		Temperature drift	≤200ppm/°C (AV), ≤300ppm/°C (all the other measurements)
		Sampling rate	6400 samples/s @ 50Hz 7680 samples/s @ 60Hz
		Display	Graph LCD backlighted (128x64 dots). Read-out for the instantaneous variables: 4x4 digit Total energies: 4x9 digit; Partial energies: 4x9 digit
		Display refresh time	100ms
		Max. and min. indication	Max. 9999 (999,999,999), Min. -9999 (-999,999,999)
		Front LED	Red Blinking light in case of vir- tual alarm Fixed light in case of digital output activation (alarm)
		Measurements	Current, voltage, power, energy, power factor, frequen- cy, harmonic distortion (see "Display Pages"). TRMS measurement of a distorted wave (voltage/current) .
		Coupling type	Direct.
		Crest factor	< 3, max 10A peak
		Input impedance	400/690V _{L-L} (AV5) 120/208V _{L-L} (AV6) Current
		Frequency	1.77 MΩ ±5% 885 kΩ ±5% ≤ 0.01Ω
		Overload protection	40 to 440 Hz
		Continuous voltage/current	(max values) AV5: 460V _{LN} , 800V _{LL} /10A AV6: 145V _{LN} , 250V _{LL} /10A
		For 500ms: voltage/current	AV5: 800V _{LN} , 1380V _{LL} /36A AV6: 240V _{LN} , 416V _{LL} /36A

Output specifications

Analogue Outputs (on request)	<p>Up to 8 (max 4 x 20mA + 4 x 10VDC or 4 x 20mA + 4 x ±5mA or 8 x 10VDC or 8 x ±5mA)</p> <p>±0.1%FS (20mA or 10VDC) ±0.3%FS (±5mA), FS=10mA</p> <p>0 to 20mA or 0 to 10 VDC or ±5mA</p> <p>Programmable within the whole range of retransmission; it allows the retransmission management of all values from: 0 and 20 mA, 0 and 10VDC, or -5mA and +5mA</p> <p>≤ 400 ms typical (filter excluded)</p> <p>≤ 1% (according to IEC 60688-1, EN 60688-1)</p> <p>≤ 500 ppm/°C</p> <p>≤ 350 Ω</p> <p>≥ 10kΩ</p> <p>≤ 1400Ω</p> <p>see "Insulation between inputs and outputs" table</p>	Ethernet/Internet port	<p>Modbus TCP</p> <p>Static IP</p> <p>Selectable (default 502)</p> <p>Max 5 simultaneously</p> <p>RJ45 10/100 Base T</p>
Number of outputs		Protocols	
Accuracy (@ 25°C ±5°C, R.H. ≤60%)		IP configuration	
Range		TCP port	
Scaling factor:		Client connections	
Response time		Connections	
Ripple		Digital outputs (on request)	
Total temperature drift		Pulse type	
Load: 20 mADC		Number of outputs	
10 VDC		Type	
±5 mA		Pulse duration	
Insulation		Alarm type	
Optical communication port	According to ANSI C12.18	Number of outputs	<p>Up to 16</p> <p>Programmable from 1.000 to 1000 pulses per Wh/varh (total and partial)</p> <p>Outputs connectable to the total and/or partial energy meters (Wh/varh)</p> <p>≥ 100ms, < 120msec (ON), ≥ 100ms (OFF)</p> <p>according to EN62053-31</p>
RS422/RS485 port (on request)	<p>Multidrop bidirectional (static and dynamic variables)</p> <p>2 or 4 wires, max. distance 1000m, termination directly on the module</p> <p>1 to 247, selectable by key-pad</p> <p>MODBUS RTU /JBUS,</p> <p>All display variables (see also the table, "List of the variables that can be connected to"...)</p> <p>All configuration parameters, reset of energy, activation of digital output</p> <p>Stored energy (EEPROM) max. 999.999.999 kWh/kvarh</p> <p>1-start bit, 8-data bit, no parity/even parity, odd parity, 1 stop bit</p> <p>9.6k, 19.2k, 38.4k, 115.2k bit/s selectable bauds</p> <p>see "Insulation between inputs and outputs" table</p>	Alarm modes	<p>up to 16, independent</p> <p>Up alarm, down alarm, in window alarm, out window alarm. All of them can be used with start up deactivation function and/or latch. All the alarms can be connected to all variables (see the table "List of the variables that can be connected to").</p> <p>from 0 to 100% of the electrical scale</p> <p>from 0 to full scale</p> <p>0 to 255s</p> <p>Selectable; normally de-energised and normally energised</p> <p>≤ 200ms, filters excluded, Set-point on-time delay: "0 s"</p> <p>The 16 digital outputs can also work as combination of pulse outputs and alarm outputs.</p>
Connections		Set-point adjustment	
Addresses		Hysteresis	
Protocol		On-time delay	
Data (bidirectional)		Output status	
Dynamic (reading only)		Min. response time	
Static (writing only)		Note	
Data format		Static (digital) outputs	
Baud-rate		Purpose	<p>(on request)</p> <p>For pulse outputs or for alarm outputs</p> <p>V_{ON} 1.2 VDC/ max. 100 mA</p> <p>V_{OFF} 30 VDC max.</p> <p>see "Insulation between inputs and outputs" table</p>
Insulation		Signal	
RS232 output (on request)	<p>Bidirectional (static and dynamic variables)</p> <p>3 wires, max. distance 15m,</p> <p>1-start bit, 8-data bit, no parity, even parity, odd parity, 1 stop bit</p> <p>9.6k bit/s</p> <p>MODBUS RTU /JBUS</p> <p>as for RS422/485</p>	Insulation	
Connections		Relay (digital) outputs	
Data format		Purpose	<p>(on request)</p> <p>For alarm outputs or for pulse outputs</p> <p>Relay SPDT</p> <p>AC 1-8A, 250VAC</p> <p>DC 12-5A, 24VDC</p> <p>AC 15-2.5A, 250VAC</p> <p>DC 13-2.5A, 24VDC</p> <p>see "Insulation between inputs and outputs" table</p> <p>≥ 10⁵ operations (@ 8A, 250 V, PF 1)</p> <p>≥ 30 - 10⁶ operations</p>
Baud-rate		Output type	
Protocol		Insulation	
Other data		Electrical life:	
		Mechanical life:	

Software functions

<p>Password</p> <p>1st level 2nd level</p>	<p>Numeric code of max 4 digits from 0 to 1000; 2 protection levels of the programming data Password "0": no protection Password from 1 to 1000: all data are protected.</p>	<p>Data stamping Type of data</p>	<p>Alarm, min, max, digital input status, digital output status as remote control, resets. All events are stored with date (dd:MM:yy) and hour (hh:mm:ss) reference</p>
<p>System selection System 1 System 2, unbalanced System 3, balanced System 3, unbalanced</p>	<p>1-phase (2 wires) 2-phase (3 wires) 3-phase (3 wires+1CT) 3-phase (3 wires) 3-phase (4 wires)</p>	<p>Number of events Data management type: Data storage type</p>	<p>Up to 10,000 FIFO Data flash</p>
<p>Transformer ratio</p>	<p>CT up to 30 kA (6000 max) VT (PT) up to 600 kV (6000 max)</p>	<p>Displaying</p>	<p>4 variables per page 1 page that can be laid out by the user</p>
<p>Filters Filter operating range Filtering coefficient Filter action</p>	<p>0.1 to 100% of the input electrical scale. 1 to 255 Display, alarms, serial outputs (fundamental variables: V, A, W and their derived ones).</p>	<p>Energy meters</p>	<p>Up to 36 pages Up to 28 pages depending on the selected tariff mode. Displaying of the consumed energy of the previous 12 months.</p>
<p>Alarms Working mode</p>	<p>"OR" or "AND" or "OR+AND" functions (see "Alarm parameter and logic" page). Freely programmable on up to 16 alarms. The alarms can be connected to any variables available in the table "List of the variables that can be connected to"</p>	<p>Stored events</p>	<p>10,000 events.</p>
<p>Reset</p>	<p>By means of the key-pad or of the configuration software, it is possible to reset the following data: - all the min, max, dmd, dmd-max values. - total and partial counters. - latch alarms. - all the events.</p>	<p>Display language</p>	<p>Selectable: English, Italian, French, German, Spanish</p>

Wm5Soft parameter programming and variable reading software

<p>Wm5Soft</p> <p>Working mode</p>	<p>Multi-language software (Italian, English, French, German, Spanish) for variable reading, instrument calibration and parameters programming. The program runs under Windows /98/98SE/2000/NT/XP. Three different working modes can be selected:</p>	<p>Data Storing Data Transfer</p>	<p>- management of local RS232 (MODBUS); - management of local optical port (MODBUS); - management of a local RS485 network (MODBUS); In pre-formatted XLS files (Excel data base). Manual or automatic at programmable timings.</p>
---	--	--	--

Time period management

Meters Total Partial and multitariff	4 (9-digit) 48 (9-digit)	Energy Meters Total energy meters	4 (+kWh, +kvarh, -kWh, -kvarh) It is possible to divide each energy meter here above listed in 3 additional energy meters (1 for each phase "L1-L2-L3")
Tariffs	Up to 12	Monthly energy meters	48 (energy meters for each month: "+kWh, +kvarh, -kWh, -kvarh")
Time periods Number of periods	Up to 24 per day Up to 100 different days per year	Partial energy meters	16 (using digital inputs: max 4 tariffs). 48 (using the internal clock: max 12 tariffs)
Pulse output	Connectable to total and/or partial meters (multitariff)	GAS/WATER meters	GAS (m ³) or WATER (hot-cold m ³) or remote heating (kWh) meters
Energy meter recording	Consumption history by recording of the monthly energy meters (12 previous months). Recording of total and partial energy meters. Energy meter recording (EEPROM) Max. 999,999,999kWh/kvarh.		

Harmonic distortion analysis

Analysis principle	FFT		
Harmonic measurement Current Voltage	Up to the 63 rd harmonic Up to the 63 rd harmonic		possible to know if the distortion is absorbed or generated. Note: if the system has 3 wires the angle cannot be measured.
Type of harmonics	THD (VL1 and VL1-N) THD odd (VL1 and VL1-N) THD even (VL1 and VL1-N) The same for the other phases: L2, L3. THD (AL1) THD odd (AL1) THD even (AL1) The same for the other phases: L2, L3.	Harmonic details	The harmonic contents is displayed as a graph showing the whole harmonic spectrum. This value is also given as a numerical information: THD % / RMS value THD even % / RMS value THD odd% / RMS value single harmonics in % / RMS value
Harmonic phase angle	The instrument measures the angle between the single harmonic of "V" and the single harmonic of "I" of the same order. According to the value of the electrical angle, it is	System	The harmonic distortion can be measured in single-phase, 3-wire or 4-wire systems. Tw: 0.02 sec@50Hz without filter

General Specifications

Operating temperature	-10° to +45°C (14° to 113°F) (R.H. < 90% non-condensing)	Pulse voltage (1.2/50µs)	EN61000-4-5
Limit range of operating temp.	-20° to +55°C (-4° to 131°F) (R.H. < 90% non-condensing)	Safety standards	IEC60664, IEC61010-1 EN60664, EN61010-1
Storage temperature	-30° to +60°C (-22° to 140°F) (R.H. < 90% non-condensing)	Measurement standards	IEC60688, EN60688, EN62053-22, EN62053-23, ANSI C12.20, ANSI C12.1
Installation category	III	Approvals	CE, cURus and CSA
Pollution degree	2	Connections 5(6) A	Screw-type max. 2.5 mm ² wires (2x 1.5mm ²) Max. screws tighteing torque: 0.5 Nm
Altitude	up to 2000m (6560 feet) above sea-level	Housing	
Insulation reference voltage	300 V _{RMS} to ground (AV5 input)	Dimensions	96x96x140 mm
Dielectric strength	4kVAC _{RMS} (for 1 min)	Material	ABS, self-extinguishing: UL 94 V-0
Noise Rejection		Protection degree	Front: IP65, NEMA4x, NEMA12
CMRR	100 dB, 48 to 62 Hz	Weight	Approx. 600 g (packing included)
EMC			
Emissions	EN61000-6-3, EN60688 residential environment, commerce and light industry		
Immunity	EN61000-6-2 industrial environment. ANSI/IEEE C37.90-1989 (surge, withstand and fast transient test)		

Supply specifications

AC/DC voltage	90 to 260V (standard) 18 to 60V (on request)	Power consumption	≤ 30VA/12W (90 to 260V) ≤ 20VA/12W (18 to 60V)
----------------------	---	--------------------------	---

Revenue approval settings

- The access to the programming parameters via front key pad and/or serial communication ports is locked.
- The front key pad (up and down keys) allows the displaying of the variables only, while the communication ports allows the transmission of the variables only.
- A proper "instrument settings" form must be filled up by the user before equipment supplying.
- WM5-96 is supplied with the desired modules plugged and sealed in the proper slots.
- WM5-96 fulfils:
 - the ANSI/IEEE C12.20-1998 requirements;
 - the CAN3-C17-M84 requirements;
 and can be certified according to:
 - C12.20-1998, class 0.5 (independent labs);
 - AE-0924 Industry Canada Approval.
 In this case there are 2 base configurations:
 1. display module + measuring input module
AV5 3 + power supply module H.
 2. display module + measuring input module
AV6 3 + power supply module H.

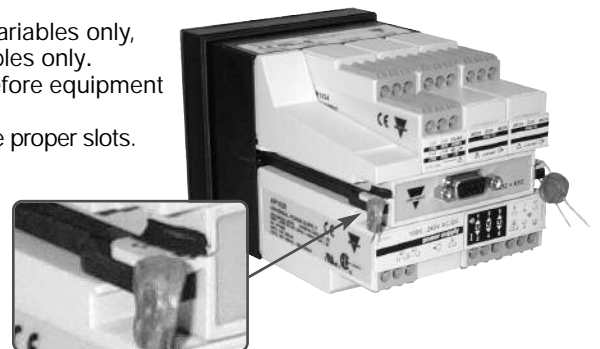

Alarm parameters and logic



- Block enable.
 - Controlled variable (VLN, ...).
 - Alarm type (up, down, window int, window ext).
 - Activation function.
 - Latch
- SET 1.
 - SET 2.
 - ON delay.
 - OFF delay.
 - Logical function (AND, OR).
 - Digital output (1 to 16).

} **A, B, C... up to 16**
parameter control blocks.

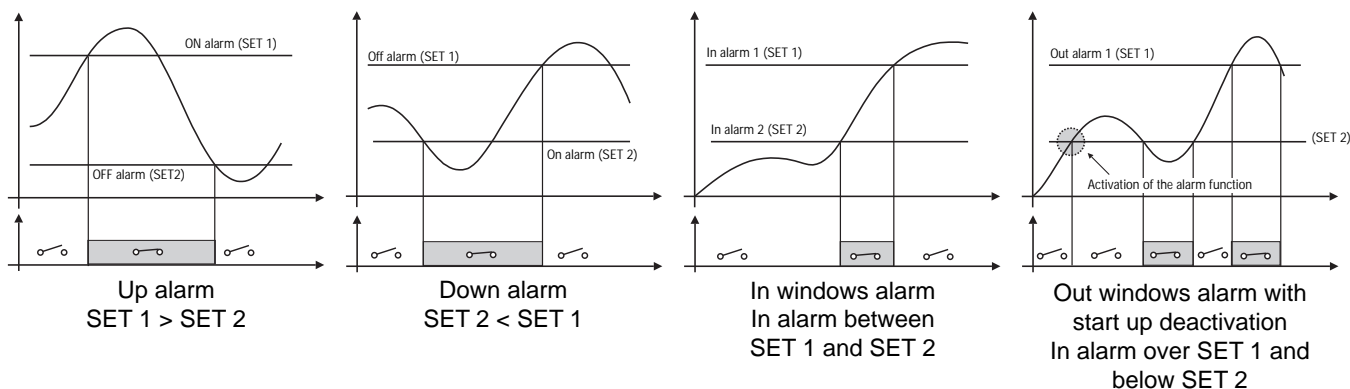

Note: any alarm working mode can be linked to the "Activation" function which disables only the first alarm at the power on of the instrument. All the alarms can be used with the latch function.

AND/OR logical alarm examples:

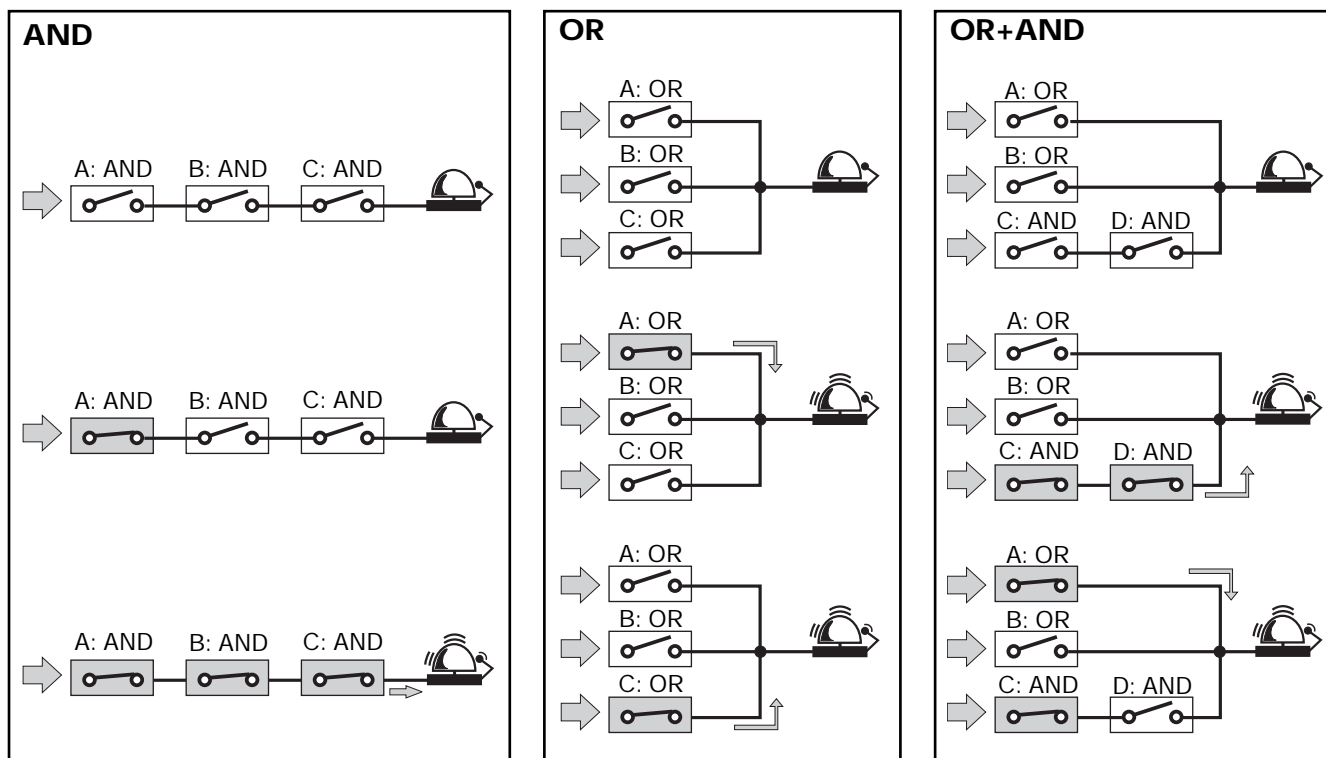

Function Description

Input and output scaling capability. Working of the analogue outputs (y) versus input variables (x)

Figure A

The sign of measured quantity and output quantity remains the same. The output quantity is proportional to the measured quantity.

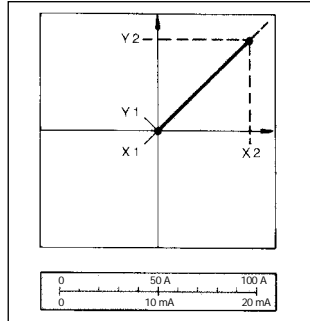

Figure D

The sign of measured quantity and output quantity remains the same. With the measured quantity being zero, the output quantity already has the value $Y1 = 0.2 Y2$. Live zero output.

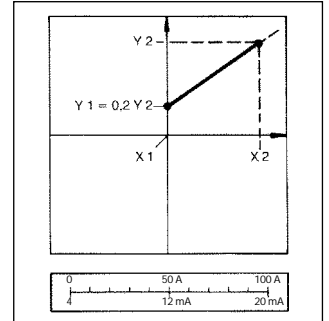

Figure B

The sign of measured quantity and output quantity changes simultaneously. The output quantity is proportional to the measured quantity.

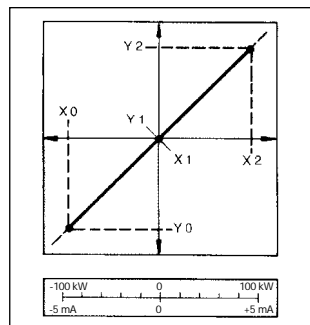

Figure E

The sign of the measured quantity changes but the one of the output quantity remains the same. The output quantity steadily increases from value X1 to value X2 of the measured quantity.

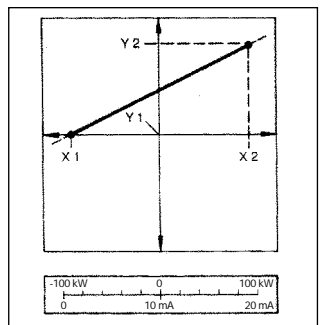

Figure C

The sign of measured quantity and output quantity remains the same. On the range X0...X1, the output quantity is zero. The range X1...X2 is delineated on the entire output range $Y0 = Y1...Y2$ and thus presented in strongly expanded form.

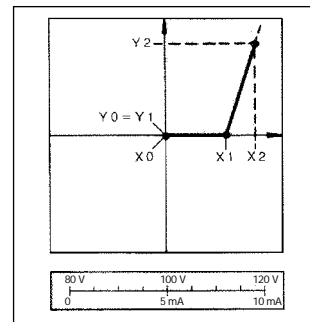
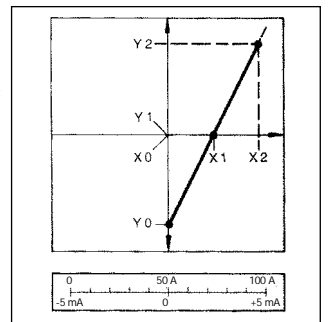

Figure F

The sign of the measured quantity remains the same, the one of the output quantity changes as the measured quantity leaves range X0...X1 and passes to range X1...X2 and vice versa.



Insulation between inputs and outputs

	Meas. /digital inputs	Relay output	Open collector output	Analogue out. 10V, 20mA	Analogue out. ±5mA	AR1034	AR2040	AR1039	Power Supply 90-260VAC/DC	Power Supply 18-60VAC/DC
Meas. /digital inputs	-	4kV	4kV	2kV	2kV	4kV	2kV	4kV	4kV	4kV
Relay output	4kV	4kV (*)	4kV	4kV	4kV	4kV	4kV	4kV	4kV	4kV
Open coll.out.	4kV	4kV	4kV (*)	4kV	4kV	4kV	4kV	4kV	4kV	4kV
Analogue out. 10V, 20mA	2kV	4kV	4kV	4kV (*)	4kV	4kV	4kV	4kV	4kV	4kV
Analogue out. ±5mA	2kV	4kV	4kV	4kV	200V (**)	4kV	4kV	4kV	4kV	4kV
AR1034	4kV	4kV	4kV	4kV	4kV	-	-	4kV	4kV	4kV
AR2040	2kV	4kV	4kV	4kV	4kV	-	-	4kV	4kV	4kV
AR1039	4kV	4kV	4kV	4kV	4kV	4kV	4kV	-	4kV	4kV
90-260VAC/DC	4kV	4kV	4kV	4kV	4kV	4kV	4kV	4kV	-	-
18-60VAC/DC	4kV	4kV	4kV	4kV	4kV	4kV	4kV	4kV	-	-

NOTE: In case of fault of first insulation the current from the measuring inputs to the ground is lower than 2 mA.

(*) The given insulation is granted among outputs plugged in different slots. The modules equipped with two or four outputs have therefore non insulation among the outputs. (**) Insulation between the 2 outputs of the same module is 200V for 1 min.



Digital outputs important note

Code	Description	Slot A	Slot B	Slot C	Slot D
AO1058	1 relay output	A0	B0	C0	D0
AO1059	1 open coll. output	A0	B0	C0	D0
AO1035	2 relay outputs	A0 A1	B0 B1	C0 C1	D0 D1
AO1036	2 open coll. outputs	A0 A1	B0 B1	C0 C1	D0 D1
AO1037	4 open coll. outputs	A1 A2 A3 A4	B1 B2 B3 B4	C1 C2 C3 C4	D1 D2 D3 D4

The grey-marked digital outputs are activated for a while during the instrument start-up, therefore they are not suggested for pulse output purpose.

Accuracy

kWh, accuracy (RDG) depending on the current

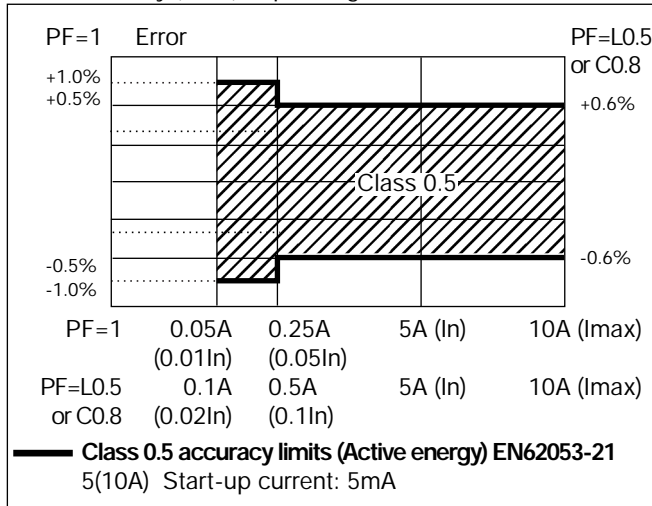

kvarh, accuracy (RDG) depending on the current

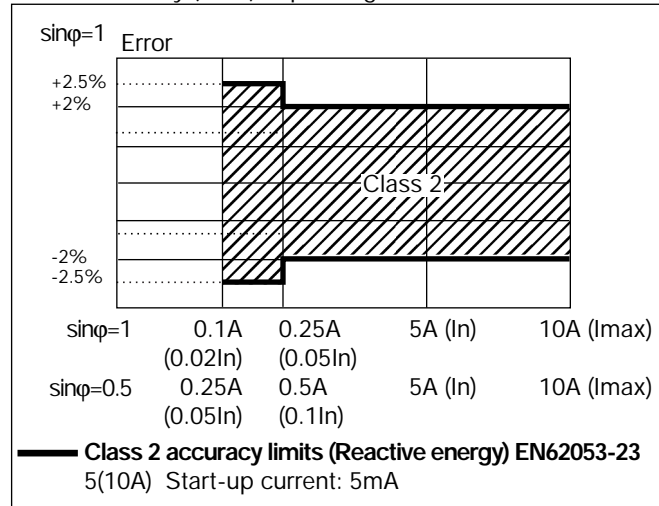

Used calculation formulas

Phase variables

Instantaneous effective voltage

$$V_{IN} = \sqrt{\frac{1}{n} \cdot \sum_1^n (V_{IN})_i^2}$$

Instantaneous active power

$$W_1 = \frac{1}{n} \cdot \sum_1^n (V_{IN})_i \cdot (A_1)_i$$

Instantaneous power factor

$$\cos\phi_1 = \frac{W_1}{VA_1}$$

Instantaneous effective current

$$A_1 = \sqrt{\frac{1}{n} \cdot \sum_1^n (A_1)_i^2}$$

Instantaneous apparent power

$$VA_1 = V_{IN} \cdot A_1$$

Instantaneous reactive power

$$VAR_1 = \sqrt{(VA_1)^2 - (W_1)^2}$$

System variables

Equivalent three-phase voltage

$$V_{\Sigma} = \frac{V_{12} + V_{23} + V_{31}}{3}$$

Voltage asymmetry

$$ASY_{LL} = \frac{(V_{LLmax} - V_{LLmin})}{V_{LL\Sigma}}$$

$$ASY_{LN} = \frac{(V_{LNmax} - V_{LNmin})}{V_{LN\Sigma}}$$

Three-phase reactive power

$$VAR_{\Sigma} = (VAR_1 + VAR_2 + VAR_3)$$

Neutral current

$$An = \bar{A}_{L1} + \bar{A}_{L2} + \bar{A}_{L3}$$

Three-phase active power

$$W_{\Sigma} = W_1 + W_2 + W_3$$

Three-phase apparent power

$$VA_{\Sigma} = \sqrt{W_{\Sigma}^2 + VAR_{\Sigma}^2}$$

Three-phase power factor

$$\cos\phi_{\Sigma} = \frac{W_{\Sigma}}{VA_{\Sigma}} \quad (TPF)$$

Energy metering

$$kWh_i = \int_{t_1}^{t_2} P_i(t) dt \cong \Delta t \sum_{n_1}^{n_2} P_{i,n}$$

$$kVarh_i = \int_{t_1}^{t_2} Q_i(t) dt \cong \Delta t \sum_{n_1}^{n_2} Q_{i,n}$$

Where:

i= considered phase (L1, L2 or L3)
P= active power; Q= reactive power;
t₁, t₂ = starting and ending time points of consumption recording; n= time unit; Δt= time interval between two successive power measurements;
n₁, n₂ = starting and ending discrete time points of power recording

List of the variables that can be connected to:

Analogue outputs (all variables with the only exception of energies), alarm outputs (all variables with the only exception of energies), pulse outputs (only energies), communication (all variables).

No	Variable	1-phase system	2-ph. 3-wire system	3-ph. 4-wire bal. (1 CT)	3-ph. 3-wire unbal. sys.	3-ph. 4-wire unbal. sys.	Notes
1	V L1	x	x	x	o	x	
2	V L2	o	x	x	o	x	
3	V L3	o	o	x	o	x	
4	V L-N sys	o	x	x	o	x	Sys = system = Σ
5	V L1-2	o	x	x	x	x	
6	V L2-3	o	o	x	x	x	
7	V L3-1	o	o	x	x	x	
8	V L-L sys	o	o	x	x	x	Sys = system = Σ
9	A L1	x	x	x	x	x	
10	A L2	o	x	x	x	x	
11	A L3	o	o	x	x	x	
12	An	o	x	x	o	x	An=neutral current
13	W L1	x	x	x	x	x	
14	W L2	o	x	x	x	x	
15	W L3	o	o	x	x	x	
16	W sys	o	x	x	x	x	
17	var L1	x	x	x	x	x	
18	var L2	o	x	x	x	x	
19	var L3	o	o	x	x	x	
20	var sys	o	x	x	x	x	Sys = system = Σ
21	VA L1	x	x	x	x	x	
22	VA L2	o	x	x	x	x	
23	VA L3	o	o	x	x	x	
24	VA sys	o	x	x	x	x	Sys = system = Σ
25	PF L1	x	x	x	x	x	
26	PF L2	o	x	x	x	x	
27	PF L3	o	o	x	x	x	
28	PF sys	o	x	x	x	x	Sys = system = Σ
29	Hz	x	x	x	x	x	
30	ASY VL-N	o	x	x	o	x	Asymmetry of phase-neutral
31	ASY VL-L	o	o	x	x	x	Asymmetry of phase-phase
32	THD V1	x	x	x	o	x	
33	THD V2	o	x	x	o	x	
34	THD V3	o	o	x	o	x	
35	THD V1-2	o	x	x	x	x	
36	THD V2-3	o	o	x	x	x	
37	THD V3-1	o	o	x	x	x	
38	THD A1	x	x	x	x	x	
39	THD A2	o	x	x	x	x	
40	THD A3	o	o	x	x	x	
41	THDo V1	x	x	x	o	x	
42	THDo V2	o	x	x	o	x	
43	THDo V3	o	o	x	o	x	
44	THDo V1-2	o	x	x	x	x	
45	THDo V2-3	o	o	x	x	x	
46	THDo V3-1	o	o	x	x	x	
47	THDo A1	x	x	x	x	x	
48	THDo A2	o	x	x	x	x	
49	THDo A3	o	o	x	x	x	
50	THDe V1	x	x	x	o	x	
51	THDe V2	o	x	x	o	x	
52	THDe V3	o	o	x	o	x	
53	THDe V1-2	o	x	x	x	x	
54	THDe V2-3	o	o	x	x	x	
55	THDe V3-1	o	o	x	x	x	
56	THDe A1	x	x	x	x	x	
57	THDe A2	o	x	x	x	x	
58	THDe A3	o	o	x	x	x	
59	Phase seq.	o	o	x	x	x	Phase sequence

(x) = available (o) = not available

Display pages

Display variables in three-phase systems, 4-wire connections

No	1st variable	2nd variable	3rd variable	4th variable	Note
0	Selectable	Selectable	Selectable	See note	kWh + kvarh meters + W% bargraph
1	V L1	V L2	V L3	V L-N sys	instant.-min-max-dmd-max dmd
2	V L1-2	V L2-3	V L3-1	V L-L sys	instant.-min-max-dmd-max dmd
3	A L1	A L2	A L3	An	instant.-min-max-dmd-max dmd
4	W L1	W L2	W L3	W sys	instant.-min-max-dmd-max dmd
5	var L1	var L2	var L3	var sys	instant.-min-max-dmd-max dmd
6	VA L1	VA L2	VA L3	VA sys	instant.-min-max-dmd-max dmd
7	PF L1	PF L2	PF L3	PF sys	instant.-min-max-dmd-max dmd
8	V L1	A L1	PF L1	W L1	instant.-min-max-dmd-max dmd
9	V L2	A L2	PF L2	W L2	instant.-min-max-dmd-max dmd
10	V L3	A L3	PF L3	W L3	instant.-min-max-dmd-max dmd
11	V L-L sys	ASY V L-L	Hz	An	instant.-min-max-dmd-max dmd
12	V L-N sys	ASY V L-N	Hz	An	instant.-min-max-dmd-max dmd
13	W sys	var sys	PF sys	VA sys	instant.-min-max-dmd-max dmd
14	THD VL1 tot	THD VL2 tot	THD VL3 tot		instant.-min-max-dmd-max dmd
15	THD VL1 odd	THD VL2 odd	THD VL3 odd		instant.-min-max-dmd-max dmd
16	THD VL1 even	THD VL2 even	THD VL3 even		instant.-min-max-dmd-max dmd
17	THD VL1-2 tot	THD VL2-3 tot	THD VL3-1 tot		instant.-min-max-dmd-max dmd
18	THD VL1-2 odd	THD VL2-3 odd	THD VL3-1 odd		instant.-min-max-dmd-max dmd
19	THD VL1-2 even	THD VL2-3 even	THD VL3-1 even		instant.-min-max-dmd-max dmd
20	THD AL1 tot	THD AL2 tot	THD AL3 tot		instant.-min-max-dmd-max dmd
21	THD AL1 odd	THD AL2 odd	THD AL3 odd		instant.-min-max-dmd-max dmd
22	THD AL1 even	THD AL2 even	THD AL3 even		instant.-min-max-dmd-max dmd
23	Histogram FFT V1 (THD, THDo, THDe, Single harmonic)				
24	Histogram FFT V2 (THD, THDo, THDe, Single harmonic)				
25	Histogram FFT V3 (THD, THDo, THDe, Single harmonic)				
26	Histogram FFT V1-2 (THD, THDo, THDe, Single harmonic)				
27	Histogram FFT V2-3 (THD, THDo, THDe, Single harmonic)				
28	Histogram FFT V3-1 (THD, THDo, THDe, Single harmonic)				
29	Histogram FFT A1 (THD, THDo, THDe, Single harmonic)				
30	Histogram FFT A2 (THD, THDo, THDe, Single harmonic)				
31	Histogram FFT A3 (THD, THDo, THDe, Single harmonic)				
32	Digital input status				
33	Digital output status				
34	Energy meters				
35	Events				
36	Alarms status				
37	Info				
38	Info				
39	Info				

Wiring diagrams

1-phase, 2-wire input connections (1P)

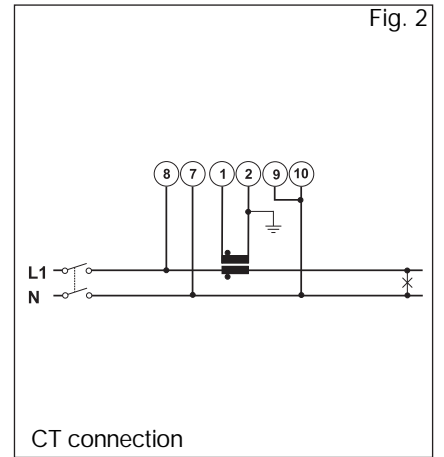
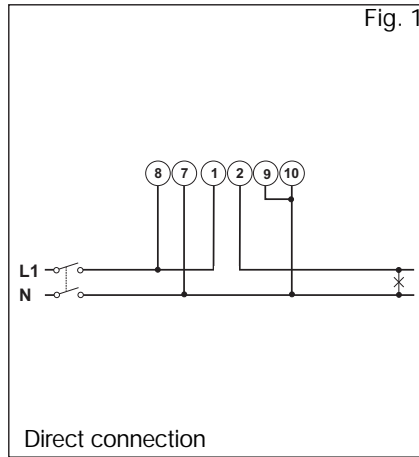
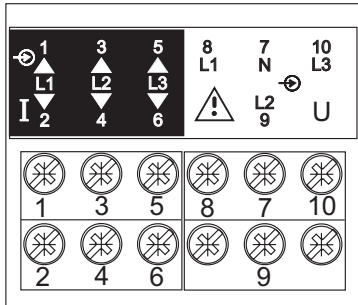

2-phase, 3-wire input connections (2P)

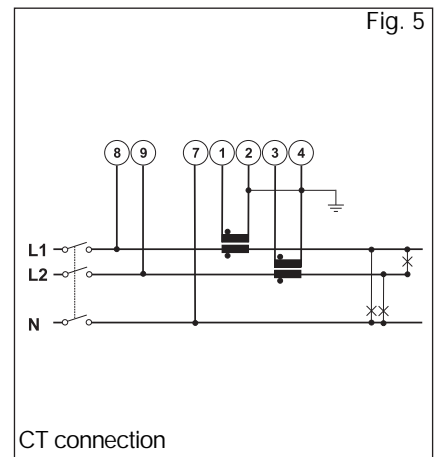
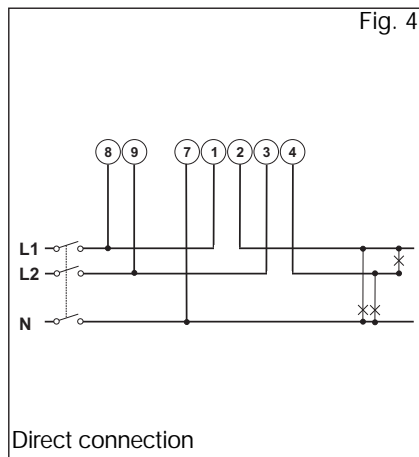
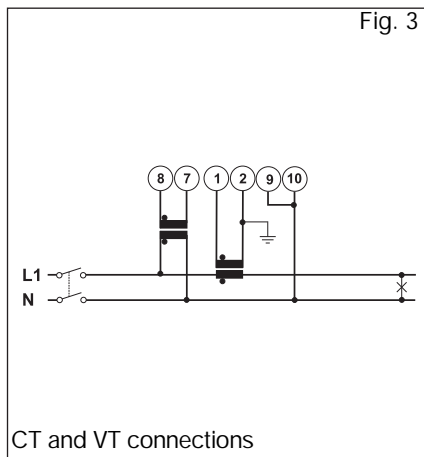

3-phase, 3 and 4-wire input connections - Balanced load (3P)

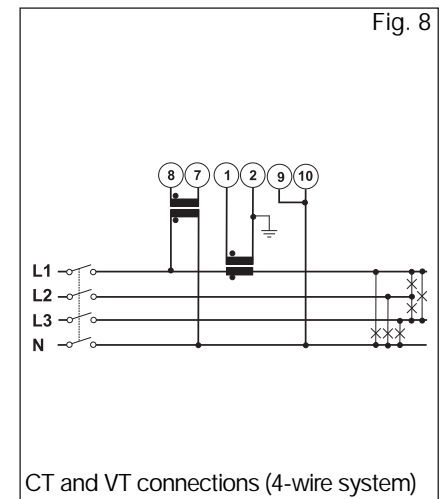
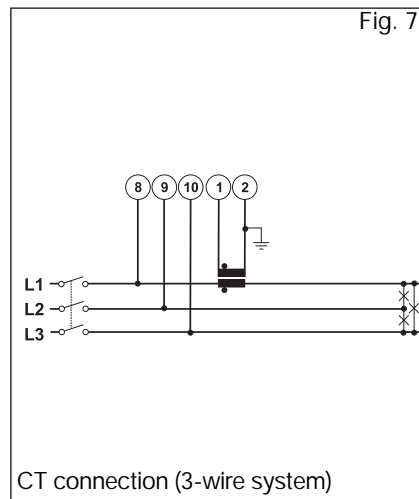
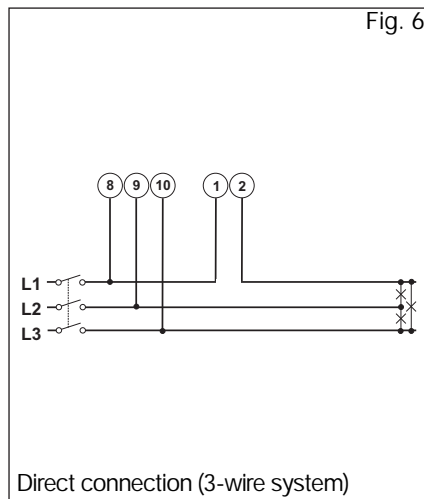

Wiring diagrams (cont.)

3-phase, 3-wire input connections - Unbalanced load (3P)

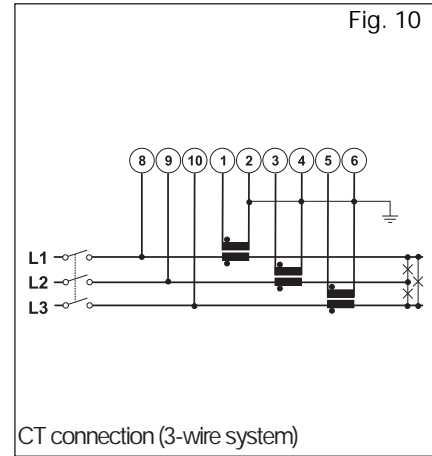
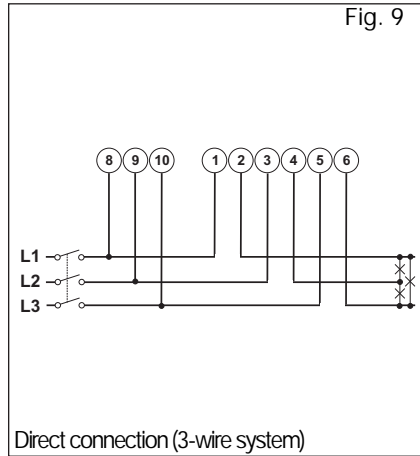
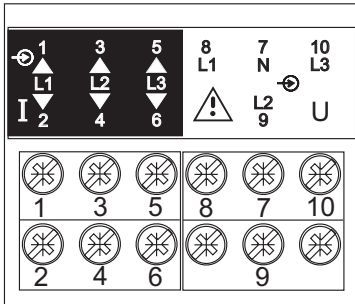

3-phase, 3-wire input connections ARON (3P)

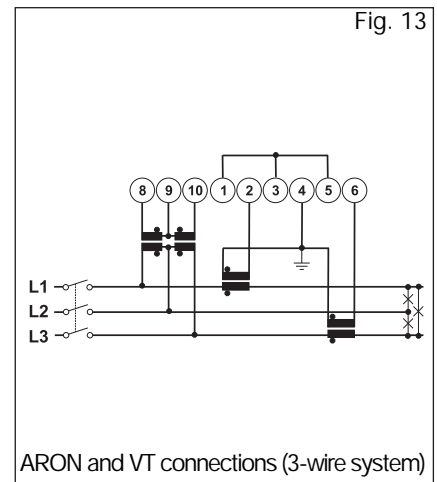
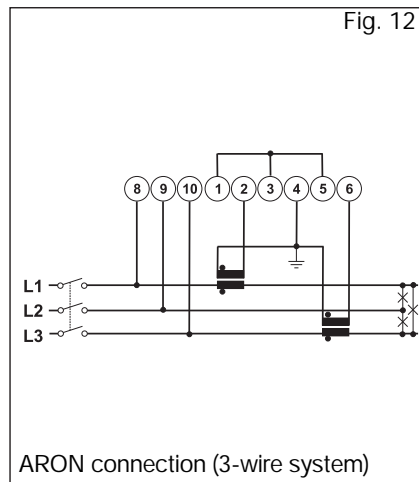
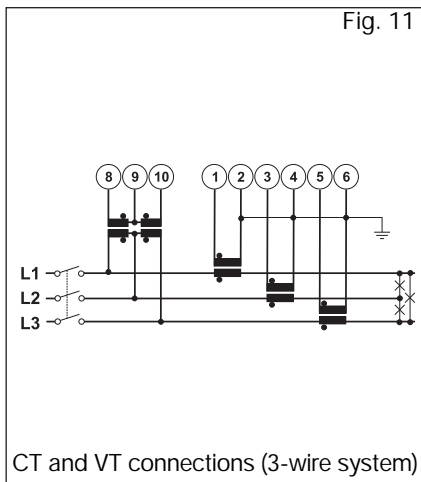

3-phase, 4 wires input connections - Unbalanced load (3p+N)

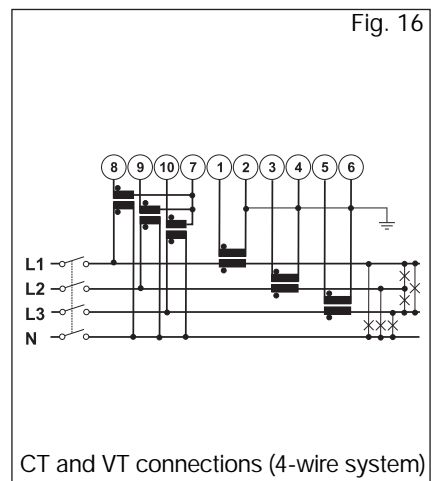
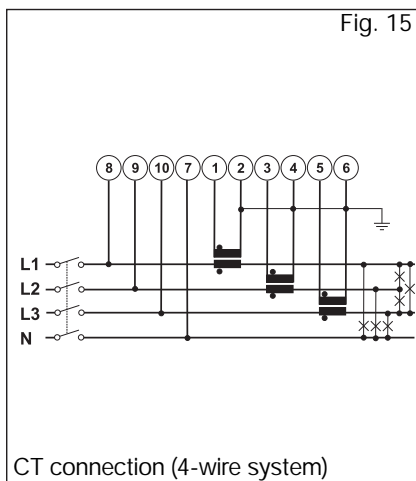
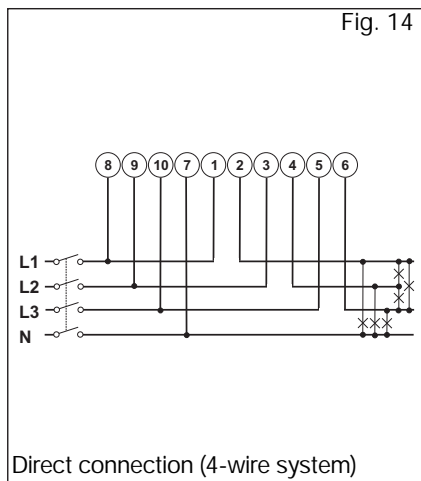

Wiring diagrams (optional modules)

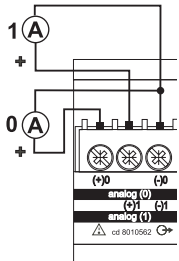

AO2050
2 analogue outputs (0-20mA)

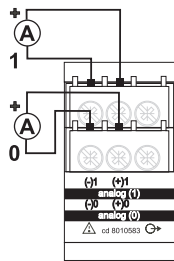

AO2052
2 analogue outputs (+/-5mA)

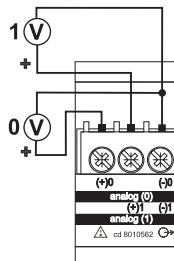

AO1051
2 analogue outputs (10V)

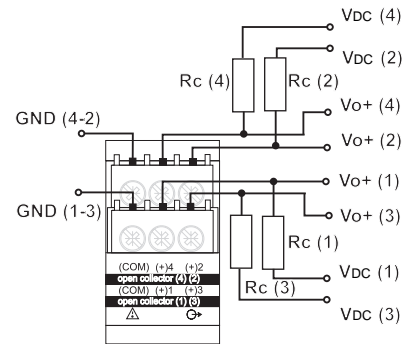

AO1037 4-open collector output connection:
This wiring diagram is valid also for the open collector module with one or two outputs. The load resistances (RC) must be designed so that the close contact current is lower than 100mA; the VDC voltage must be lower than or equal to 30VDC.

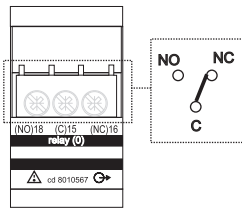

AO1058
1 relay output

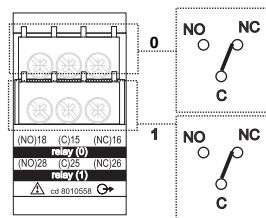

AO1035
2 relay outputs

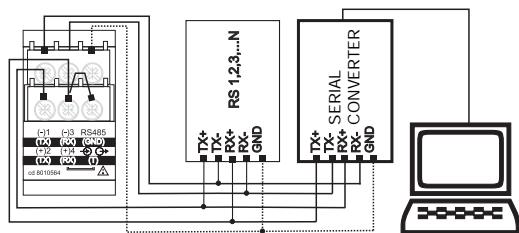

AR1034/AR2040
4-wire connection of RS485 serial port

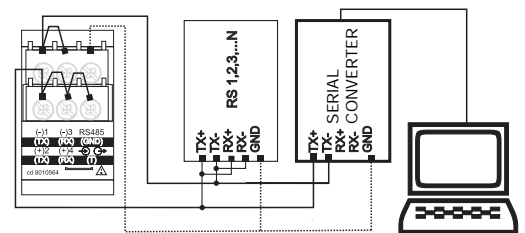

AR1034/AR2040
2-wire connection of RS485 serial port

RS422/485 NOTE: additional devices provided with RS422/485 (that is RS 1, 2, 3...N) are connected in parallel. The termination of the serial output is carried out only on the last instrument of the network, by means of a jumper between (RX+) and (T).

Wiring diagrams: digital input modules

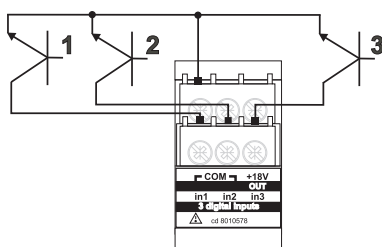

AQ1042
Connection by means of NPN transistors.

AQ1042
Connection by means of PNP transistors.

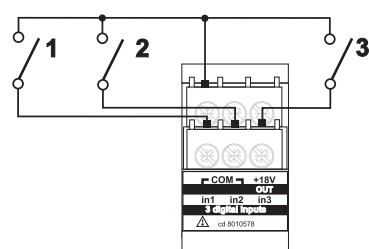
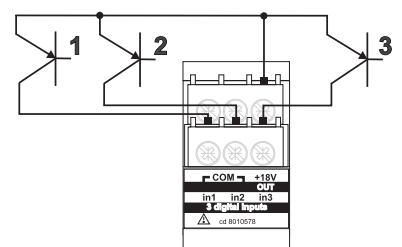

AQ1042
Connection by means of contacts.

AQ1038
Connection by means of contacts.

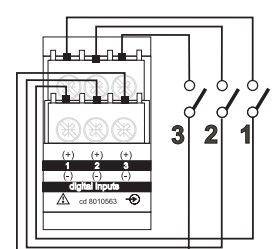

Front panel description

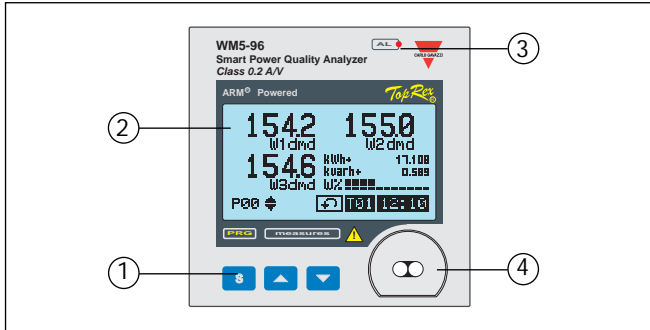

▲ and ▼

1. Key-pad

Set-up, programming and display parameters are easily controlled by the 3 push-buttons.

- [S] to enter programming and to confirm password.

2. Display

Instantaneous measurements:

- 4 digits (max display 9999)

Energies:

- 9 digits (max display 999 999 999).

Alphanumeric indications by means of LCD display for:

- Display of configuration parameters
- All measuring variables.

3. LED

Alarm LED.

4. Optical Port

For data reading and programming (or pulse output).

Dimensions

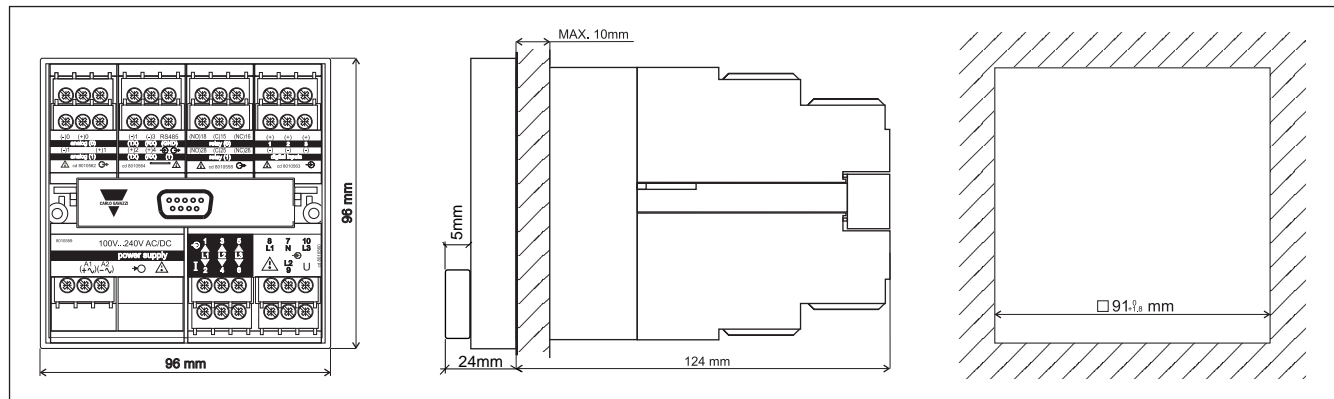

Modules

Dual analogue output modules

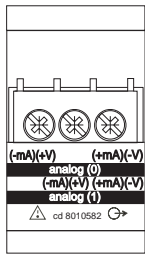

AO2050 (20mADC)
AO2051 (10VDC)

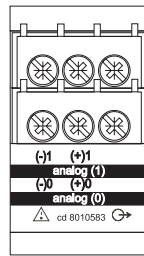

AO2052 (+/-5mADC)

Digital output modules

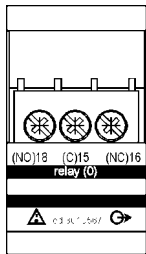

AO1058
Single relay output

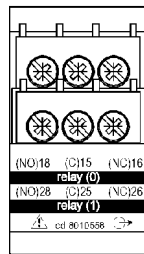

AO1035
Dual relay output

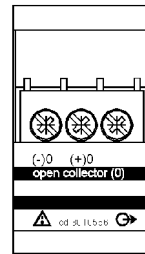

AO1059
Single open collector output

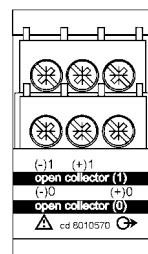

AO1036
Dual open collector output

Other input/output modules

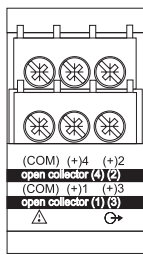

AO1037
4 open collector outputs

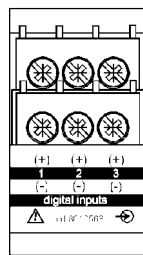

AO1038
3 digital inputs

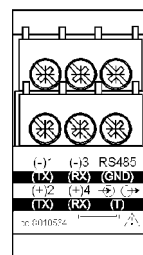

AR1034
AR2040
RS485 port

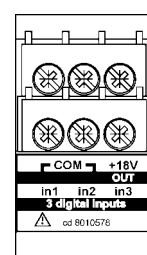

AQ1042
3 digital inputs + aux

Power supply modules

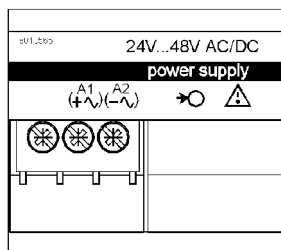

AP1021
18-60VAC/DC power supply

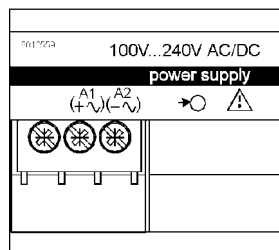

AP1020
90-260 VAC/DC power supply



AR1039
RS232 port + RTC

X-ON Electronics

Largest Supplier of Electrical and Electronic Components

Click to view similar products for [Power Analysers](#) category:

Click to view products by [Carlo Gavazzi](#) manufacturer:

Other Similar products are found below :

[AQ1018](#) [AQ1038](#) [AR1039](#) [AD1016H](#) [AD1040](#) [MOA2](#) [MOO2](#) [MOR2](#) [EM2172DAV63XOSX](#) [AQ1042](#) [AD1047](#) [58250-1854](#)
[WM20AV53H](#) [AD2000](#) [AQ2030](#) [AR1060](#) [EM24DINAV93XISX](#) [EM2696AV53HR2S1XX](#) [EM50DINMA53HRSMC](#) [MC485232](#) [MCETH](#)
[MFI6R4](#) [WM1496AV53CX](#) [WM1496AV63CX](#) [WM1496AV63DS](#) [WM30AV53H](#) [WM30AV63H](#) [WM30AV63L](#) [WM40AV53H](#)
[WM50AV53HBC](#) [CS-BB3-04](#) [58250-1852](#) [58250-1853](#) [TOL-18585](#) [WM1596AV53XOSPFB](#) [WM1596AV53XOSX](#)
[WM1596AV53XOXPFB](#) [WM1596AV53XOXX](#) [EM24DINAV53DISX](#) [EM28072DMV53X2SX](#) [EM28072DMV63X2SX](#)
[EM50DINAV53HRSX](#) [EM50DINRG53HRSX](#) [EM50DINMV53HRSX](#) [WM1496AV53HDG](#) [WM14-96AV63CS](#) [58430-1286](#)