

# CD34CNFLFxxx

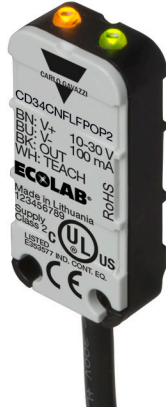

## Capacitive sensor, Foreground Suppression



### Main features

- Compact housing
- Supply voltage: 10 to 30 VDC
- Output: 100 mA, NPN or PNP preset
- Make or break switching function
- LED indication for output and power ON
- Protection: reverse polarity, short circuit and transients
- Cable and pigtail M8 plug versions
- Excellent EMC performance
- IP65, IP66, IP67, IP68 and IP69K for hose-down applications
- cULus
- Ecolab

### Description

The CD34.. capacitive sensor is designed for detecting water-based (conductive) liquids through a non-metallic container wall, and it automatically adapts to various thicknesses of plastic or glass walls.

The universal mounting brackets allow the sensor to be fixed on various tubes or containers. Strong, compact housing with IP69K ratings and ECOLAB approval for wash-down applications. The sensor will function out of the box in most applications, and teach-in capabilities are available for adapting the sensor to more challenging applications.

### Main functions

- Detection of water-based fluids inside a container or tube without direct contact with the fluids.
- The sensor detects the liquids reliably while compensating for residue film, moisture or foam build-up from liquids such as water, milk, body fluids (blood), acid- or alkaline solutions with conductivity as high as 50 mS/cm inside or outside the container wall.
- Flexible and fast universal mounting bracket.
- The sensing principle detects only the level of the liquids while ignoring foam, film or build-up that would cause standard capacitive sensors to detect faultily.

## References

### Product selection key

 CD34CNFLF   

 Enter the code option instead of 

Code	Option	Description
C	-	Capacitive sensor
D	-	Rectangular housing
34	-	Length of housing
C	-	Plastic housing
N	-	Neutral
F	-	Flush mounting
L	-	Liquid level
F	-	Foreground suppression
<input type="checkbox"/>	N	NPN
	P	PNP
<input type="checkbox"/>	O	N.O.
	C	N.C.
<input type="checkbox"/>	P2	2 m PVC Cable
	T5	Pigtail PVC

### Type selection

Conne- ction	Output	Code
Cable	NPN, N.O.	CD34CNFLFNOP2
	NPN, N.C.	CD34CNFLFNCP2
	PNP, N.O.	CD34CNFLFPOP2
	PNP, N.C.	CD34CNFLFP2P2
Pigtail	NPN, N.O.	CD34CNFLFNOT5
	NPN, N.C.	CD34CNFLFNCT5
	PNP, N.O.	CD34CNFLFPOT5
	PNP, N.C.	CD34CNFLFPCT5
Mounting bracket		ACD34-MB01

## Structure

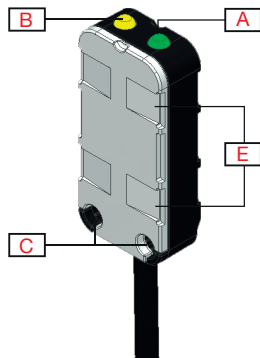

Fig. 1 Cable

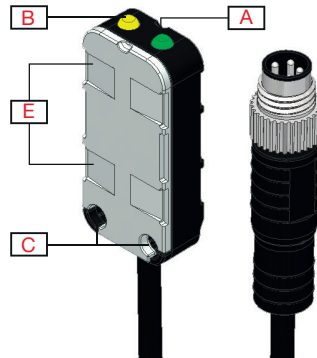

Fig. 2 Pigtail

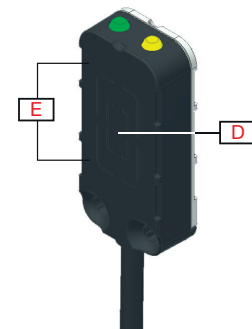

Fig. 3 Sensing surface

Element	Component	Function
A	LED	Green LED: Power ON
B	LED	Yellow LED: Output
C	2 M3	Fixing holes for sensor mounting
D	Sensing surface	
E	Recessed area for cable strips, max. 5 mm wide	

## Sensing

### Accuracy

Temperature drift	Factory settings	$\leq 20\%$ (-25°C... +80°C)
	Manual teach	$\leq 20\%$ (-25°C... +60°C)
Detection	Pipes diameter	Min. $\varnothing$ 8 mm
	Out of the box: wall thickness	Plastic 0.5 - 6 mm (non-conductive plastic wall)
		Glass 0.5 - 4 mm (non-conductive glass wall)
	With manual setup: wall thickness	Up to 10 mm plastic wall (best case)
Up to 10 mm glass wall (best case)		
Detection liquids	Water-based liquids such as water, milk, syrup, honey, milkshakes, lubricates, acids, alkaline fluids, body fluids and other high-conductive liquids (up to 50 mS)	

## Features

### Power Supply



Rated operational voltage ( $U_B$ )	10 ... 30 VDC (ripple included)
Ripple ( $U_{rpp}$ )	$\leq 10\%$
No load supply current ( $I_o$ )	$\leq 13$ mA
Power-ON delay ( $t_v$ )	< 300 ms

### Outputs

Output functions	NPN or PNP by sensor type	
Output switching function	N.O. and N.C. by sensor type	
Rated operational current ( $I_o$ )	$\leq 100$ mA	
OFF-state current ( $I_o$ ) PNP and NPN	50 $\mu$ A	
Voltage drop ( $U_d$ )	< 1.5 V	
Protection	Short circuit, reverse polarity and transients	
Utilization category	DC-1	Control of resistive loads and solid-state loads with optical isolation
	DC-13	Control of electromagnets
Load capacitance max at ( $U_o$ )	330 nF	

### Operation diagram

$T_v$  = Power-ON delay

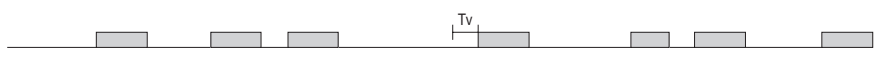
Power supply	ON	
Target	Present	
Break output (N.C.)	ON	
Make output (N.O.)	ON	

### Response times

Operating frequency (f)	$\leq 10$ Hz	
Response times	$\leq 50$ ms	OFF-ON ( $t_{ON}$ )
	$\leq 50$ ms	ON-OFF ( $t_{OFF}$ )

## Indication

### Normal mode

Green LED	Yellow LED	Power	Output
OFF	OFF	OFF	OFF
ON	OFF	ON	OFF
ON	ON	ON	ON

### Output short circuit

Green LED	Yellow LED	Output
OFF	Flashes 4Hz	Yellow LED flashes minimum 1 sec.

### Teach by wire

#### Out of the box (Factory settings):

Typically, the sensor can be used without any additional calibration; it is designed to work with plastic tank walls of approximately 0,5 to 6 mm in thickness and glass walls of approximately 0,5 to 4 mm in thickness. It is important that the glass or plastic is nonconductive.

#### Calibration:

If the factory settings are insufficient, the sensor is teachable to either Full or Empty.

#### Calibration Full:

The sensor switch point is set below the actual detection value to ensure that slight changes in the application will not affect the sensing performance.

In most applications, the full calibration on a full tank or tube will be sufficient.

In critical applications with large variations in media type and temperature, it can be an advantage to teach the Full level with approximately 50 % of the active sensing surface covered.

#### Full calibration procedure:

- Connect teach wire to V+ for 2 - 7 seconds
- The green LED flashes 1 imp. per sec. and the yellow LED is OFF
- After successful calibration, the yellow LED flashes 3 times (with 1 Hz)

#### Calibration Empty:

The sensor switch point is set above the actual detection value to ensure that slight changes in the application will not affect the sensing performance.

In most applications, the Empty calibration on an empty tank or tube will be sufficient.

In critical applications with a high amount of residue film, moisture or foam build-up, an Empty calibration can be performed with the build-up present.

#### Empty calibration procedure:

- Connect teach wire to V+ for 7 - 12 seconds
- The green LED flashes 1 imp. per sec. and the yellow LED is ON
- After successful calibration, the yellow LED flashes 3 times (with 1 Hz)

#### Cancel calibration procedure:

- Keep the teach wire connected to V+ for more than 14 seconds to abort teach procedure. The switch points will remain unchanged.
- The green LED is off and the yellow LED flashes (4 Hz)

Green LED	Yellow LED	Output
Flashes 1Hz	OFF	Full calibration (2-7 sec)
Flashes 1Hz	ON	Empty calibration (7-12 sec)
NA	Flashes 3 times 1Hz	Successful "full calibration"
NA	Flashes 3 times 1Hz	Successful "empty calibration"
NA	Flashes 10 times 4Hz	Unsuccessful calibration (cancelled or error) (>12 sec)

## Environmental

Ambient temperature	-25°... +80°C (-13°... +176°F)	Operating
	-40° ... +85°C (-40° ... +185°F)	Storage
Ambient humidity range	35% ... 100%	Operating
	35% ... 100%	Storage
Vibration	10 ...150 Hz, 1.0 mm/15 g	EN 60068-2-6
Shock	30 gn / 11ms, 6 pos, 6 neg per axis	EN60068-2-27
Drop test	2 x 1 m and 100 x 0.5 m	EN 60068-2-31
Rated insulation voltage (U <sub>i</sub> )	75 VDC	
Dielectric insulation voltage	≥ 1250 VAC rms	50/60 Hz for 1 min.
Rated impulse withstand voltage	1 kV	1.2/50 μs
Pollution degree	3	ICE60664, ICE60664A, EN60947-1
Overvoltage category	III	IEC60664; EN60947-1
Degree of protection	IP65, IP66, IP67, IP68 @ 1.3m and 24 h	IEC60539; EN60947-1
	IP69K	DIN 40050-9
NEMA Enclosure Types	1, 2, 4, 4x, 5, 12	NEMA 250

## EMC

Electrostatic discharge immunity test	± 8 kV @ air discharge or ± 4 kV @ contact discharge	IEC 61000-4-2, EN60947-1
Electromagnetic field immunity	3 V/m	IEC 61000-4-3, EN60947-1
Fast transient immunity	2 kV	IEC 61000-4-4, EN60947-1
Wire-conducted noise	3 V	IEC 61000-4-6, EN60947-1
Power frequency magnetic field immunity test	30 A/m	IEC 61000-4-8, EN60947-1

## Mechanics/electronics

### Connection

<b>Cable</b>	2 m, 4-wire 4 x 0.14 mm <sup>2</sup> , Ø = 3.4 mm, PVC
<b>Pigtail</b>	0.3 m, M8, 4-pin, male

### Wiring

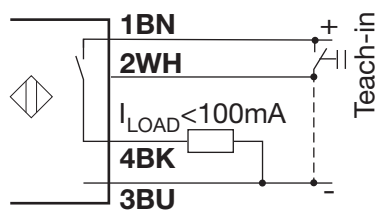

Fig. 4 PNP NO

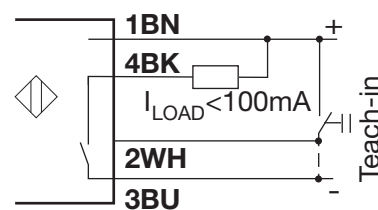

Fig. 5 NPN NO

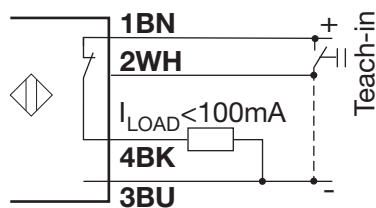

Fig. 6 PNP NC

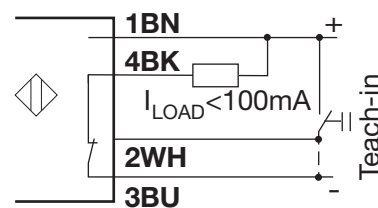

Fig. 7 NPN NC

NOTE: White wire connected to GND (3BU) wire when not in use

BN	WH	BK	BU
Brown	White	Black	Blue

### Housing

<b>Body</b>	PC/PBT	
<b>Mounting bracket</b>	PC/PBT	
<b>Light guides</b>	Polyamid TR55, Transparent	
<b>Pigtail</b>	Black TPU (Thermoplastic polyurethane), Stainless steel AISI 304	
<b>Dimensions</b>	8 x 16 x 34 mm	
<b>Weight</b>	≤ 60 g	Cable version
	≤ 30 g	Pigtail version
<b>Tightening torque, Sensor</b>	0.2 Nm	
<b>Tightening torque, Mounting bracket</b>	0.2 Nm	
<b>Screw size</b>	M3 (with lowered head)	

Dimensions (mm)

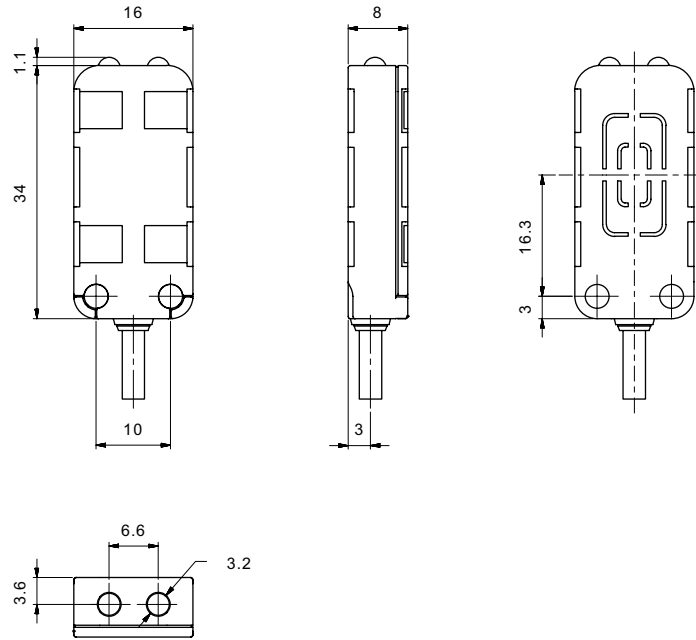

Fig. 8 CD34

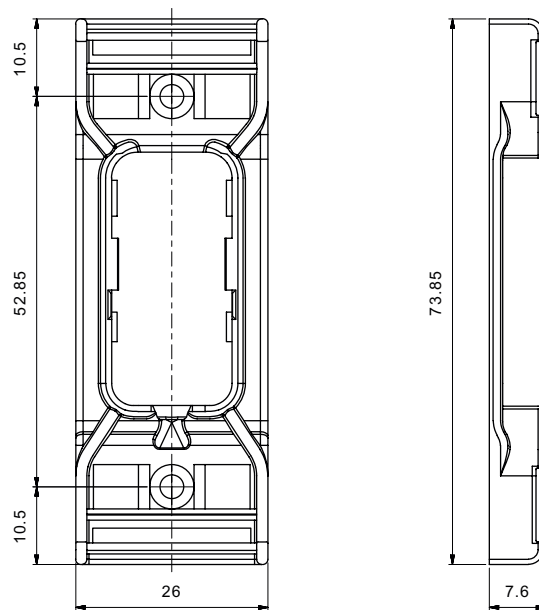





Fig. 9 Mounting bracket (ACD34-MB01)



## Compatibility and conformity

### Approvals and markings

<b>General reference</b>	Sensor designed according to EN60947-5-2 and EN60947-1	
<b>MTTF<sub>d</sub></b>	246 years @ 40°C (+104°F)	EN ISO 13849-1, SN 29500
<b>CE-marking</b>		
<b>Approvals</b>	 (UL508 + C22.2)	
<b>Other Approvals</b>		Topax 56, Topaz AC1, Topaz MD3, Topaz CL1, Topactiv OKTO, P3-hypochloran

## Delivery contents and accessories

### Delivery contents

- Capacitive sensor: CD34CNFLF...
- Mounting bracket: ACD34-MB01
- 2 x Foam pads 3 mm (for pipe mounting)
- 2 x Adhesive pads 1 mm (for screwless surface mounting)
- Quick installation guide

### Further information

Information	Where to find it	QR
Manual	<a href="http://cga.pub/?262c4a">http://cga.pub/?262c4a</a>	



COPYRIGHT ©2020  
 Content subject to change. Download the PDF: [www.gavazziautomation.com](http://www.gavazziautomation.com)

## X-ON Electronics

Largest Supplier of Electrical and Electronic Components

*Click to view similar products for [Liquid Level Sensors](#) category:*

*Click to view products by [Carlo Gavazzi](#) manufacturer:*

Other Similar products are found below :

[FSH-21](#) [FSH-25](#) [FSH-34](#) [FSH-35](#) [FSV-31](#) [FSV-35](#) [RSF54H100R1/8](#) [LRNH31S41](#) [F03-16SFC-10M](#) [F03-16SF-5M](#) [F03-16PE-5M](#) [F03-16PT-5M](#) [LBFS 1151](#) [SCN-1518SC](#) [LL103000](#) [LRNR31N01](#) [MS03-PP](#) [F03-16SF-10M](#) [KSL-100-1](#) [LS01-1B66-PP-500W](#) [LS02-1B66-S-500W](#) [LS02-1B85-PP-5000W](#) [LS03-1A85-PP-500W](#) [LRNH31S42](#) [59630-1-T-02-F](#) [LS04-1B66-2-500W](#) [LFFS 011](#) [T0-SKF-0.5](#) [T0-SKF-10](#) [T0-SKF-5](#) [VNI3](#) [CLP2FA1BM24](#) [VNI1](#) [LBFS 0111](#) [LFFS 014](#) [KSL-88-PP](#) [KSL-99-1](#) [LS02-1A85-PP-500W](#) [LS02-1B85-PP-500W](#) [LS03-1A85-PA-500W](#) [MIC 1000-20](#) [700670](#) [BAF147B002-00A0](#) [DFT-110](#) [DFT-220](#) [A94-10](#) [CA30CLL30BP](#) [CA30CLL30BPM1](#) [CLE1](#) [CLE1K](#)