

Conductive Sensors 2-point level controller Type CL with potentiometer

CARLO GAVAZZI



- Conductive level controller
- Sensitivity adjustment from 250 Ω to 500 KΩ
- For filling or emptying applications
- Low-voltage AC electrodes
- Easy installation on DIN rails or with 11 pin circular plug
- Rated operational voltage:
24 VAC/DC, 115 VAC or 230 VAC
- Output 2 x 8A/250 VAC DPDT relay
- LED indication for: Output ON and Power ON



Product Description

μ-Processor based level controller for liquids with a wide sensitivity range (like sewage water, chemicals, salt water etc.).

Max./min. control of charging/discharging. The sensitivity is adjustable by means of the potentiometer and the rotary switch.
2 x 8A DPDT relay output.

Ordering Key

CLD2EA1CM24

- Conductive level
- DIN rail or plug mounting
- No of inputs
- Charge/discharge
- Adjustment potentiometer
- O output
- Relay DPDT
- Power supply

Type Selection

Mounting	Relay	Ordering no. Supply: 24 VAC/DC	Ordering no. Supply: 115 VAC	Ordering no. Supply: 230 VAC
DIN-rail	DPDT	CLD2EA1CM24	CLD2EA1C115	CLD2EA1C230
11-p circular plug		CLP2EA1CM24	CLP2EA1C115	CLP2EA1C230

Specifications

Rated operational voltage (U_B)				
Pin 2 & 10	230	195 to 265 VAC, 45 to 65 Hz		Ranges S (Standard sensitivity) 5 KΩ to 100 KΩ, C _F * = 2.2 nF
	115	98 to 132 VAC, 45 to 65 Hz		Ranges H (High sensitivity) 50 KΩ to 500 KΩ, C _F * = 1.0 nF
Supply class 2	24	19.2 to 28.8 VAC/DC		
Rated insulation voltage		<2.0 kVAC (rms)		Dielectric voltage >2.0 KVAC (rms) (contacts / electronics)
Rated impulse withstand voltage		4 kV (1.2/50 μs) (line/neutral)		Rated impulse withstand volt. 4 kV (1.2/50 μs) (contacts / electronics) (IEC 664)
Rated operational power				Operating frequency (f) Relay output 0.5 HZ
AC supply		5 VA		Response time
AC/DC supply		5 VA / 5 W		OFF-ON (t _{on}) 1 s
Delay on operate (t_v)		< 300 mS		ON-OFF (t _{off}) 1 s
Outputs				Environment
Rated insulation voltage		250 VAC (rms) (cont./elec.)		Overvoltage category III (IEC 60664)
Relay Rating (AgCdO)				Degree of protection IP 20 (IEC 60529, 60947-1)
Resistive loads	AC1	μ (micro gap)		Pollution degree 2 (IEC 60664/60664A, 60947-1)
	DC1	8 A / 250 VAC (2500 VA)		
		1 A / 250 VDC (250 W)		Temperature
		or 10 A / 25 VDC (250 W)		Operating -20° to +50°C (-4° to + 122°F)
Small induc. Loads	AC15	0,4 A / 250 VAC		Storage -50° to +85°C (-58° to +185°F)
	DC13	0,4 A / 30 VDC		
Mechanical life (typical)		≥ 30 x 10 ⁶ operations		Housing material
		@ 18'000 imp/h		CLP NORYL PPO, light grey
Electrical life (typical)	AC1	> 250'000 operations		CLD ABS VO, light grey
Level probe supply		Max. 5 VAC		Weight
Level probe current		Max. 2 mA		AC supply 200 g
Sensitivity		250Ω to 500KΩ		AC/DC supply 125 g
		Factory settings standard range "S" 100KΩ		UL Approvals cURus UL508, UL325, CSA-C22.2 No.247
Ranges L (Low sensitivity)		250 Ω to 5 KΩ, C _F * = 4.7 nF		CE marking Yes

*C_F = maximum Cable Capacitance

Mode of Operation

Connection cable

2, 3, or 4 conductor PVC cable, normally screened. Cable length: max. 100 m. The resistance between the cores and the ground must be at least 500k. Normally, it is recommended to use a screened cable between probe and controller, e.g. where the cable is placed in parallel to the load cables (mains). The screen has to be connected to Y3 (reference).

Example 1

The diagram shows the level control connected as max. and min. control. The relays react to the low alternating current created when the

electrodes are in contact with the liquid. The reference (Ref) must be connected to the container or if the container consists

of a non-conductive material, to an additional electrode. (To be connected to pin Y3). (In the diagram this electrode is shown by the dotted line).

NB!

If only one level detection is required - interconnect the two inputs Y1 and Y2.

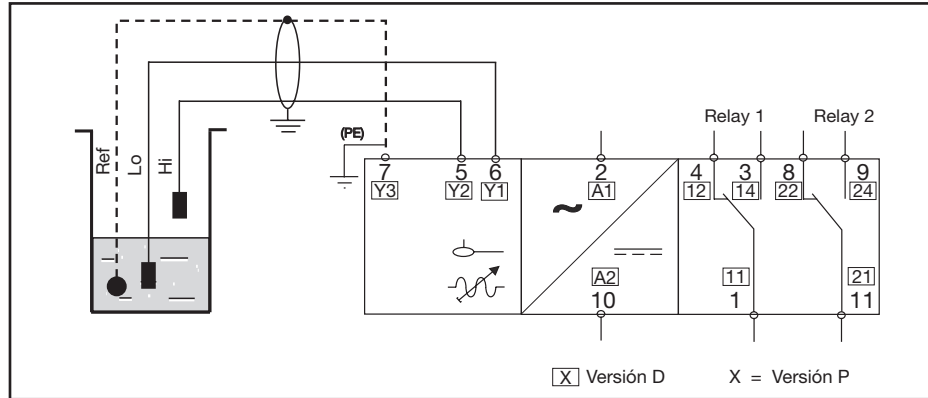

Filling

Power supply ON

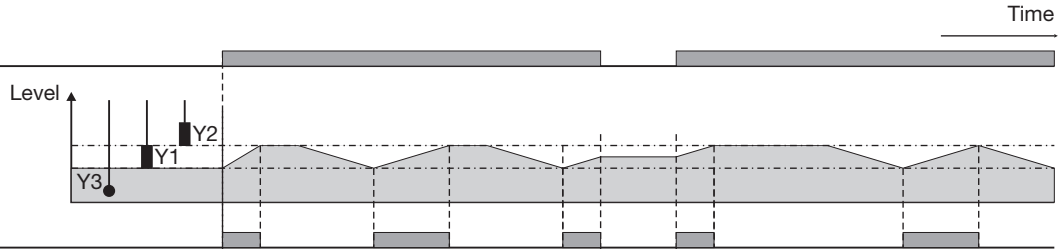

Emptying

Power supply ON

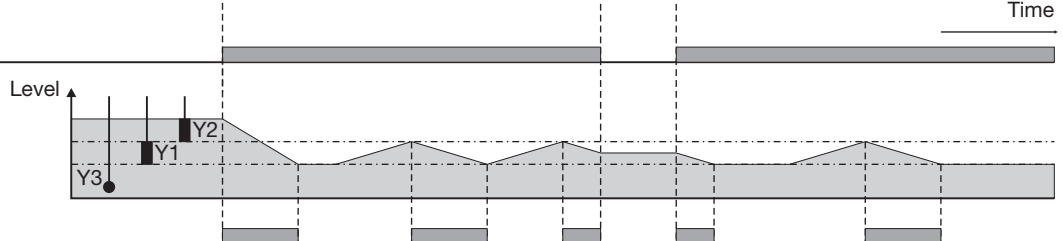
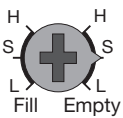

[D-version] (P-version)

Wiring Diagram

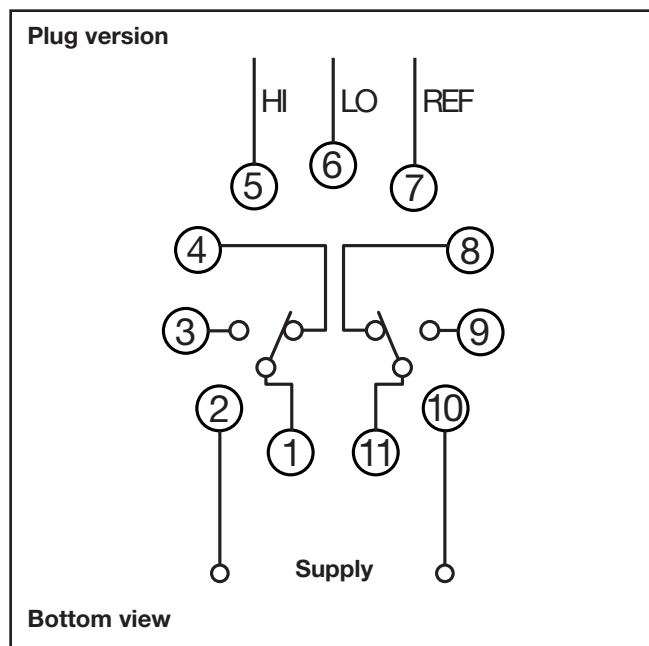
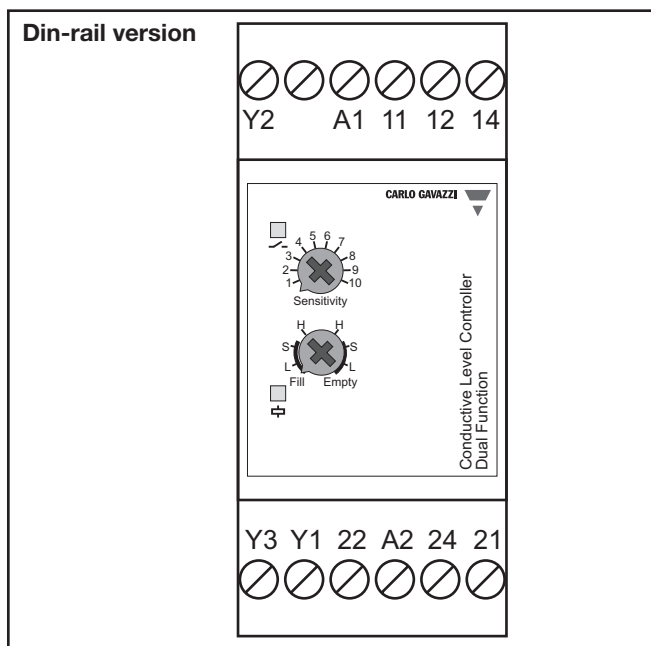

Dimension Drawings

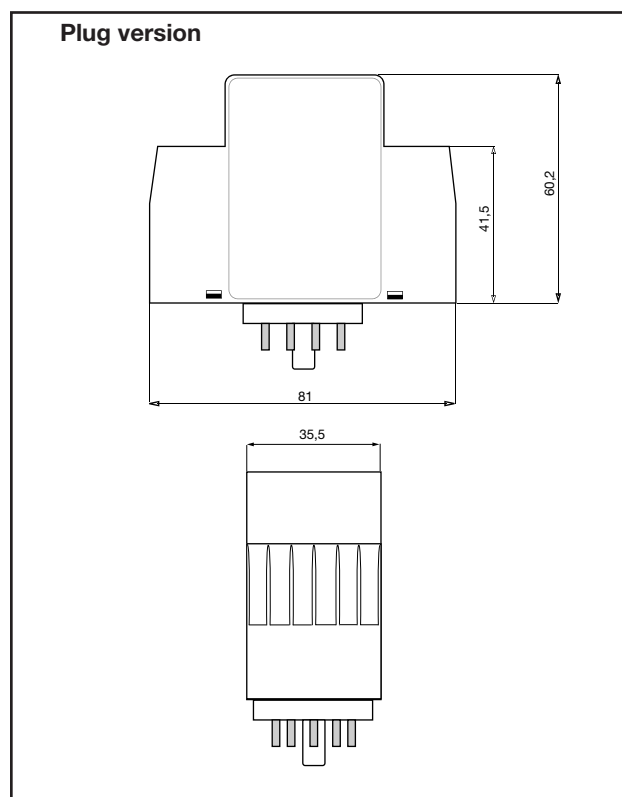
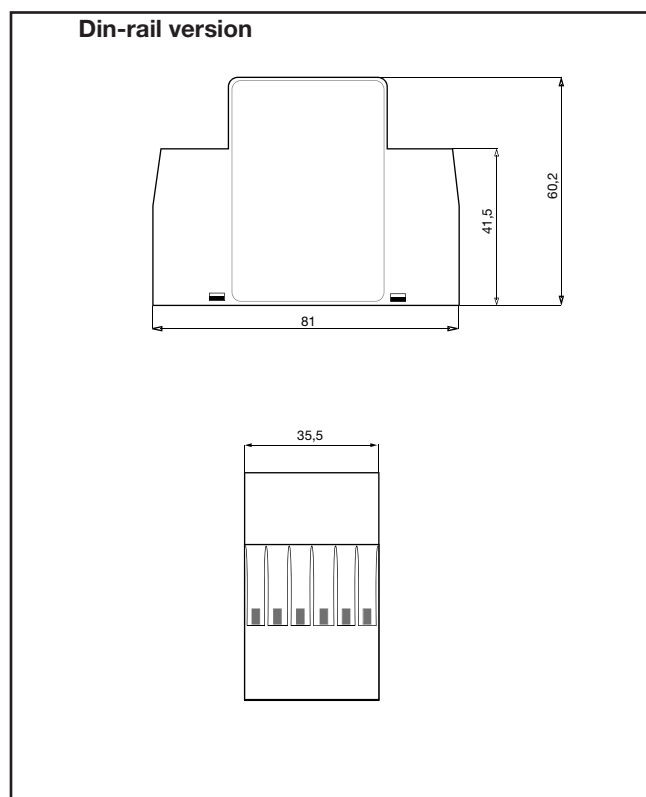

Accessories

- 11 pole circular socket ZPD11
- Retaining spring HF

Delivery Contents

- Amplifier
- Packaging: Carton box
- Manual

X-ON Electronics

Largest Supplier of Electrical and Electronic Components

Click to view similar products for [Controllers](#) category:

Click to view products by [Carlo Gavazzi](#) manufacturer:

Other Similar products are found below :

[61FGPN8DAC120](#) [CV500SLK21](#) [70177-1011](#) [F03-03 HAS C](#) [F03-31](#) [81550401](#) [FT1A-C12RA-W](#) [FT1A-C14SA-B](#) [88981106](#) [H2CAC24A](#)
[H2CRSAC110B](#) [R88A-CRGB003CR-E](#) [R88ARR080100S](#) [R88A-TK01K](#) [DCN1-1](#) [DRT2ID08C](#) [DTB4896VRE](#) [DTB9696CVE](#)
[DTB9696LVE](#) [E53-AZ01](#) [E53E01](#) [E53E8C](#) [E5C4Q40J999FAC120](#) [E5CWLQ1TCAC100240](#) [E5GNQ03PFLKACDC24](#) [B300LKL21](#)
[NSCXDC1V3](#) [NSH5-232CW-3M](#) [NT20SST122BV1](#) [NV-CN001](#) [OAS-160-N](#) [C40PEDRA](#) [K31S6](#) [K33-L1B](#) [K3MA-F](#) [100-240VAC](#)
[K3TX-AD31A](#) [89750101](#) [L595020](#) [SRM1-C02](#) [SRS2-1](#) [FT1A-C14SA-S](#) [G32X-V2K](#) [26546803](#) [26546805](#) [H7HP-C8D](#) [PWRA440A](#)
[CPM1AETL03CH](#) [CV500SLK11](#) [3G2A5BI081](#) [3G2A5IA122](#)