

# Conductive Sensors 2 to 4-point level controller Type CL with potentiometer

CARLO GAVAZZI



- Conductive level controller
- Adjustment of sensitivity – operating resistance from 250Ω to 500KΩ
- Multiple combinations of filling and emptying applications
- Low-voltage AC electrodes
- Easy installation on DIN rails or with 11 pin circular plug
- Rated operational voltage:  
24 VAC/DC, 115 VAC or 230 VAC
- Output 2x8A/250 VAC SPDT relay
- LED indication for: Output ON and Power ON



## Product Description

μ-Processor based level controller for liquids with a wide sensitivity range (like sewage water, chemicals, salt water etc.). The controller has a separate output for alarm indication in case of a tank

running dry or if an overflow condition occurs.  
8A SPDT/SPST relay output, NO/NC.  
Sensitivity control by potentiometer level in 3 ranges.

## Ordering Key

**CLD4MA2DM24**

Type \_\_\_\_\_  
 DIN rail mounting \_\_\_\_\_  
 Inputs \_\_\_\_\_  
 Function \_\_\_\_\_  
 Adjustment \_\_\_\_\_  
 Outputs \_\_\_\_\_  
 Relay versions \_\_\_\_\_  
 Power supply \_\_\_\_\_

## Type Selection

Mounting	Relay	Ordering no. Supply: 24 VAC/DC	Ordering no. Supply: 115 VAC	Ordering no. Supply: 230 VAC
DIN-rail	SPDT + SPST	CLD4MA2DM24	CLD4MA2D115	CLD4MA2D230
11-p circular plug	2 SPST	CLP4MA2AM24	CLP4MA2A115	CLP4MA2A230

## Specifications

<b>Rated operational voltage (U<sub>B</sub>)</b>					
Pin 2 & 10	230	195 to 265 VAC, 45 to 65 Hz			Ranges H (High sensitivity)
	115	98 to 132 VAC, 45 to 65 Hz			50 KΩ to 500 KΩ, C <sub>F</sub> * = 1.0 nF
Supply class 2	24	19.2 to 28.8 VAC/DC			<b>Dielectric voltage</b>
Rated insulation voltage		<2.0 kVAC (rms)			>2.0 KVAC (rms) (contacts / electronics)
Rated impulse withstand voltage		4 kV (1.2/50 μs) (line/neutral)			<b>Rated impulse withstand volt.</b>
					4 kV (1.2/50 μs) (contacts / electronics) (IEC 664)
<b>Rated operational power</b>					<b>Operating frequency (f)</b>
AC supply	5 VA				Relay output
AC/DC supply	5 VA / 5 W				0.5 HZ
<b>Delay on operate (t<sub>v</sub>)</b>	< 300 mS				<b>Response time</b>
<b>Outputs</b>		Make or break on rotary-switch			OFF-ON (t <sub>on</sub> )
Rated insulation voltage		250 VAC (rms) (cont./elec.)			ON-OFF (t <sub>off</sub> )
<b>Relay Rating (AgCdO)</b>					1 s
Resistive loads	AC1	μ (micro gap)			1 s
	DC1	8 A / 250 VAC (2500 VA)			<b>Environment</b>
		1 A / 250 VDC (250 W)			Overvoltage category
		or 10 A / 25 VDC (250 W)			III (IEC 60664)
Small induc. Loads	AC15	0,4 A / 250 VAC			Degree of protection
	DC13	0,4 A / 30 VDC			IP 20 (IEC 60529, 60947-1)
Mechanical life (typical)		≥ 30 x 10 <sup>6</sup> operations			Pollution degree
		@ 18'000 imp/h			2 (IEC 60664/60664A, 60947-1)
Electrical life (typical)	AC1	> 250'000 operations			<b>Temperature</b>
<b>Level probe supply</b>					Operating
<b>Level probe current</b>					Storage
<b>Sensitivity</b>					-20° to +50°C (-4° to + 122°F)
		250Ω to 500KΩ			-50° to +85°C (-58° to +185°F)
		Factory settings standard range "S" 100KΩ			<b>Housing material</b>
		250 Ω to 5 KΩ, C <sub>F</sub> * = 4.7 nF			CLP
		5 KΩ to 100 KΩ, C <sub>F</sub> * = 2.2 nF			CLD
Ranges L (Low sensitivity)					NORYL PPO, light grey
Ranges S (Standard sensitivity)					ABS VO, light grey
					<b>Weight</b>
					AC supply
					200 g
					AC/DC supply
					125 g
					<b>Approvals</b>
					UL
					CSA
					cULus
					UL508, UL325, CSA-C22.2 No.247
					<b>CE marking</b>
					Yes

\*C<sub>F</sub> = maximum Cable Capacitance

Specifications are subject to change without notice (20.05.2014)



## Mode of Operation

### Connection cable

2, 3, 4 or 5 conductor PVC cable, normally screened. Cable length: max. 100 m. The resistance between the cores and the ground must be at least 500k. Normally, it is recommended to use a screened cable between probe and controller, e.g. where the cable is placed in parallel to the load cables (mains). The screen has to be connected to Y5 (reference).

react to the low alternating current created when the electrodes are in contact with the liquid.

The reference (Ref) must be connected to the container or if the container consists of a non-conductive material, to an additional electrode. (To be connected to pin Y5).

In the diagram this electrode is shown by the dotted line.)

The alarm outputs utilize alarm - and Y1 for LoLo alarm outputs.

### Example 1

The diagram shows the level control connected as max. and min. control, i.e. registration of 2 levels + 2 alarm levels. The relays

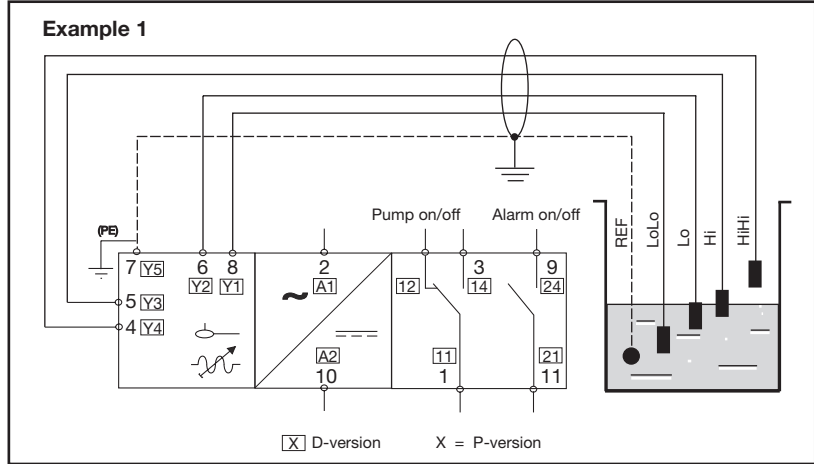

## Operation Diagram

### Function: Filling or Emptying

The Multifunction Controller can be used as a minimum-maximum control for two systems, a filling system and an emptying system, with the same kind of liquid to be measured and one common pump.

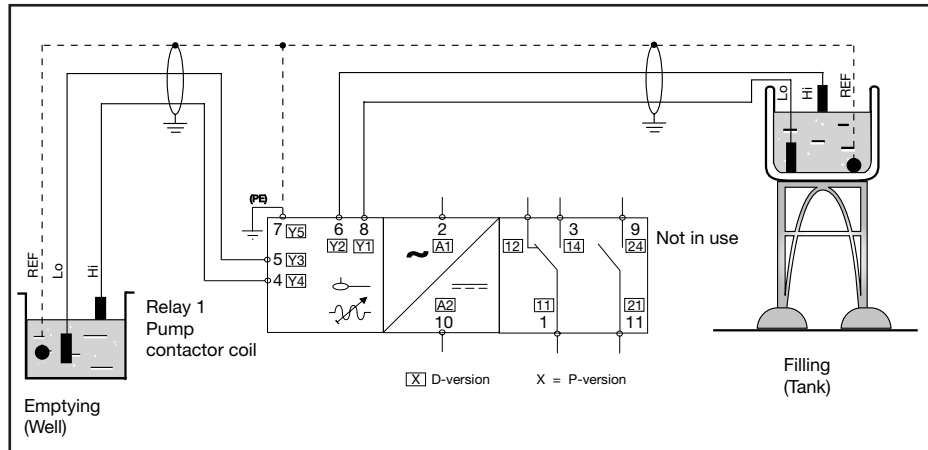

### Tank-Well application (Filling and emptying)

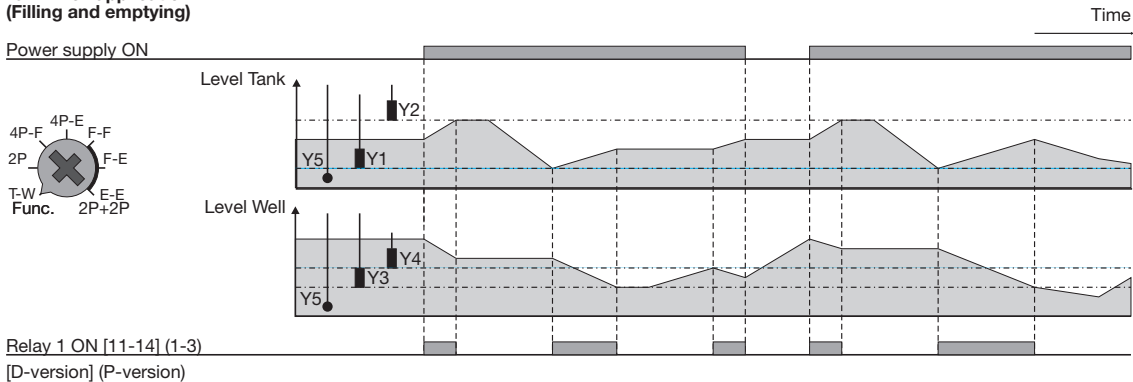

## Operation Diagram

**Function: Direct input- output**  
 The Multifunction Controller can be used as direct input/ output, where each of the two inputs (electrodes) controls an individual relay output:  
 Electrode no. 1 = Relay no. 1  
 Electrode no. 2 = Relay no. 2.

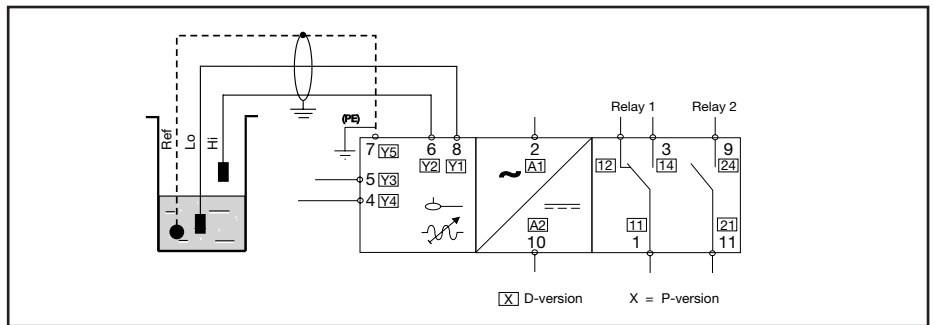

**2-Probe (Direct Input to output)**

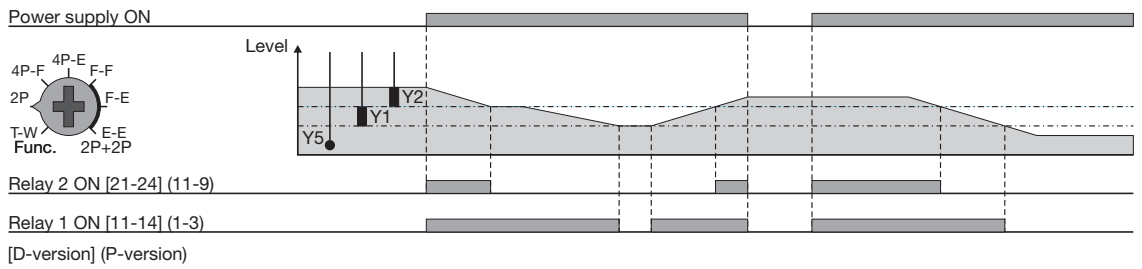

**Function: Filling or Emptying with high and low alarms**

The Multifunction Controller can be used as a minimum-maximum control filling or emptying system, with HiHi and LoLo Alarm output.

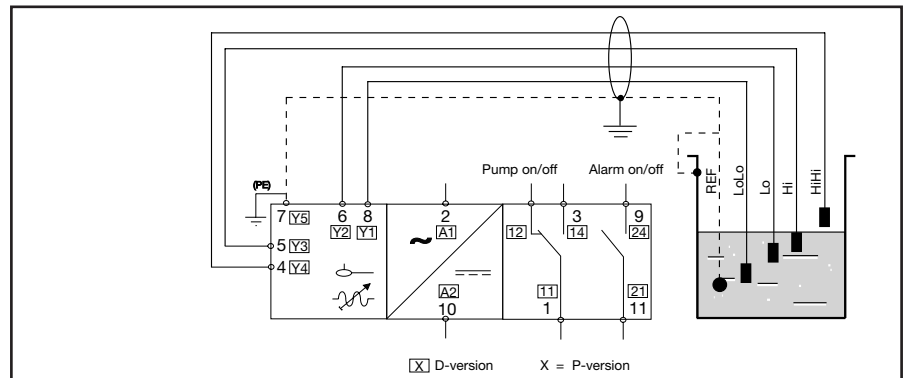

**4-Probe Filling (Low and High alarm)**

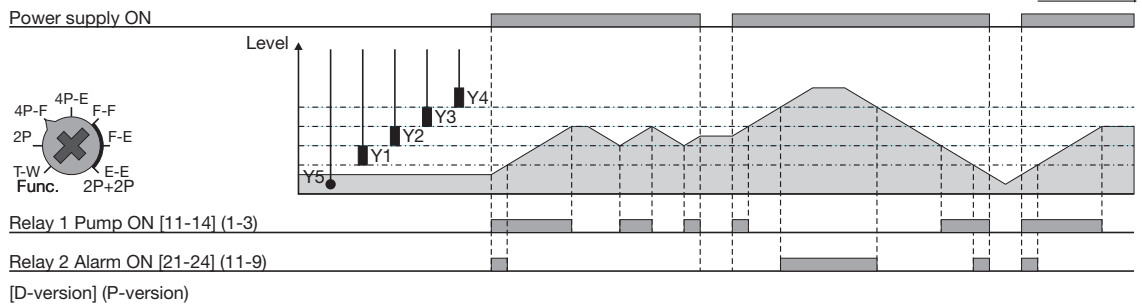

**4-Probe Emptying (Low and High alarm)**

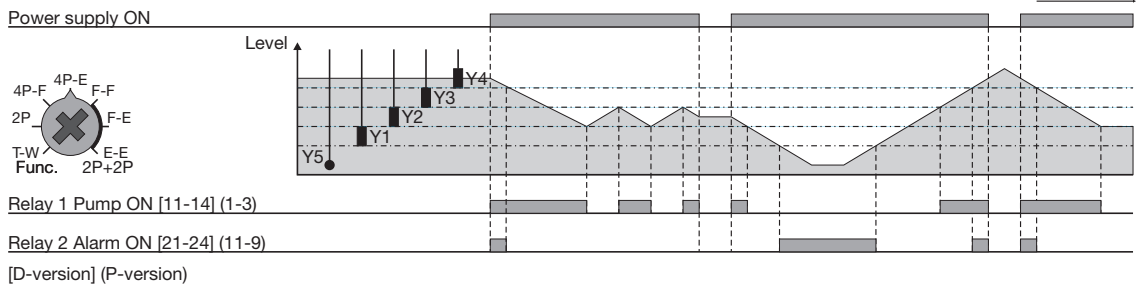

## Operation Diagram

**Function: Filling or Emptying**  
 The Multifunction Controller can be used as a minimum-maximum control for up to two individual systems, with the same kind of liquid to be measured.

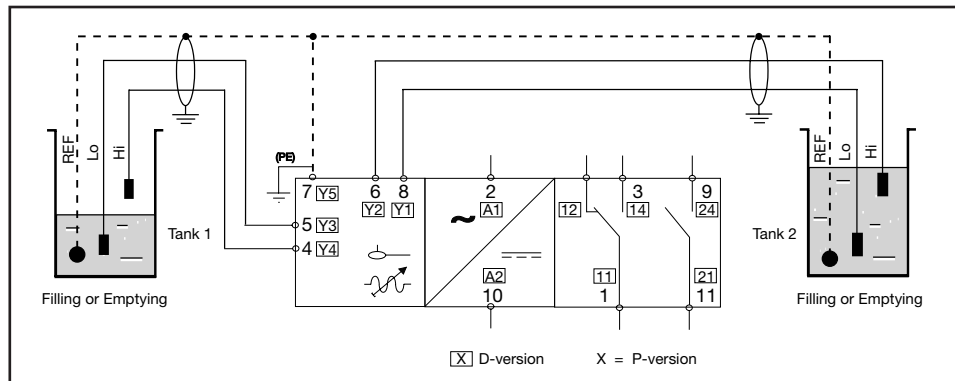

### 2 Individual systems (Filling and/or emptying)

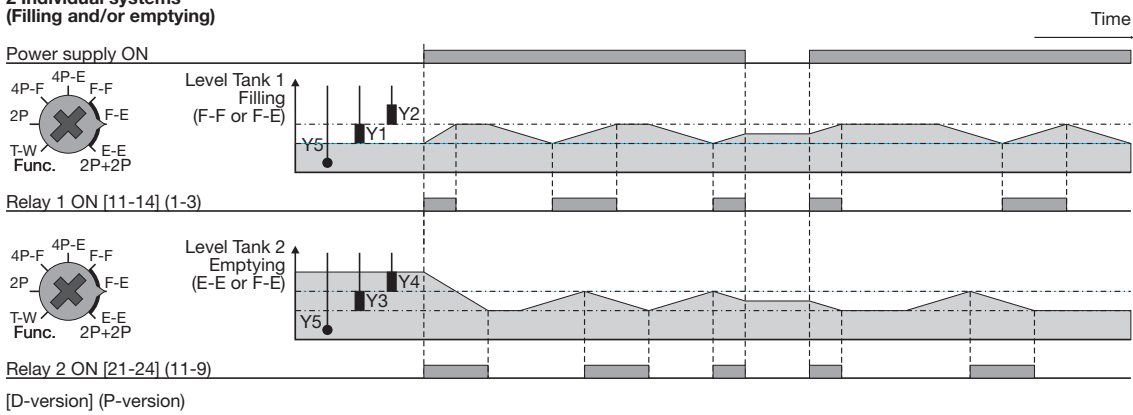

## Wiring Diagram

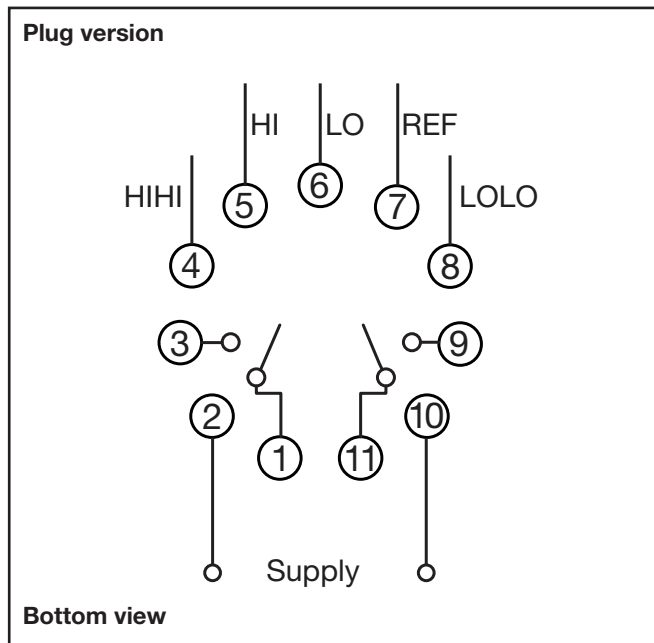
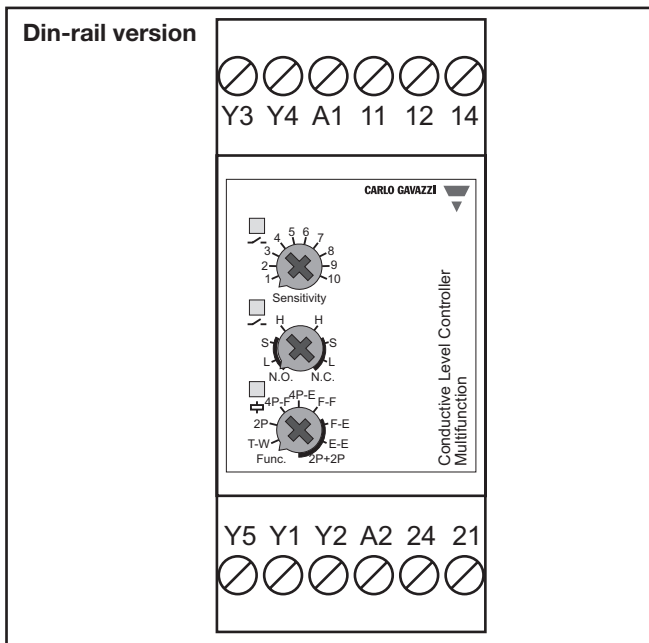

## Dimension Drawings

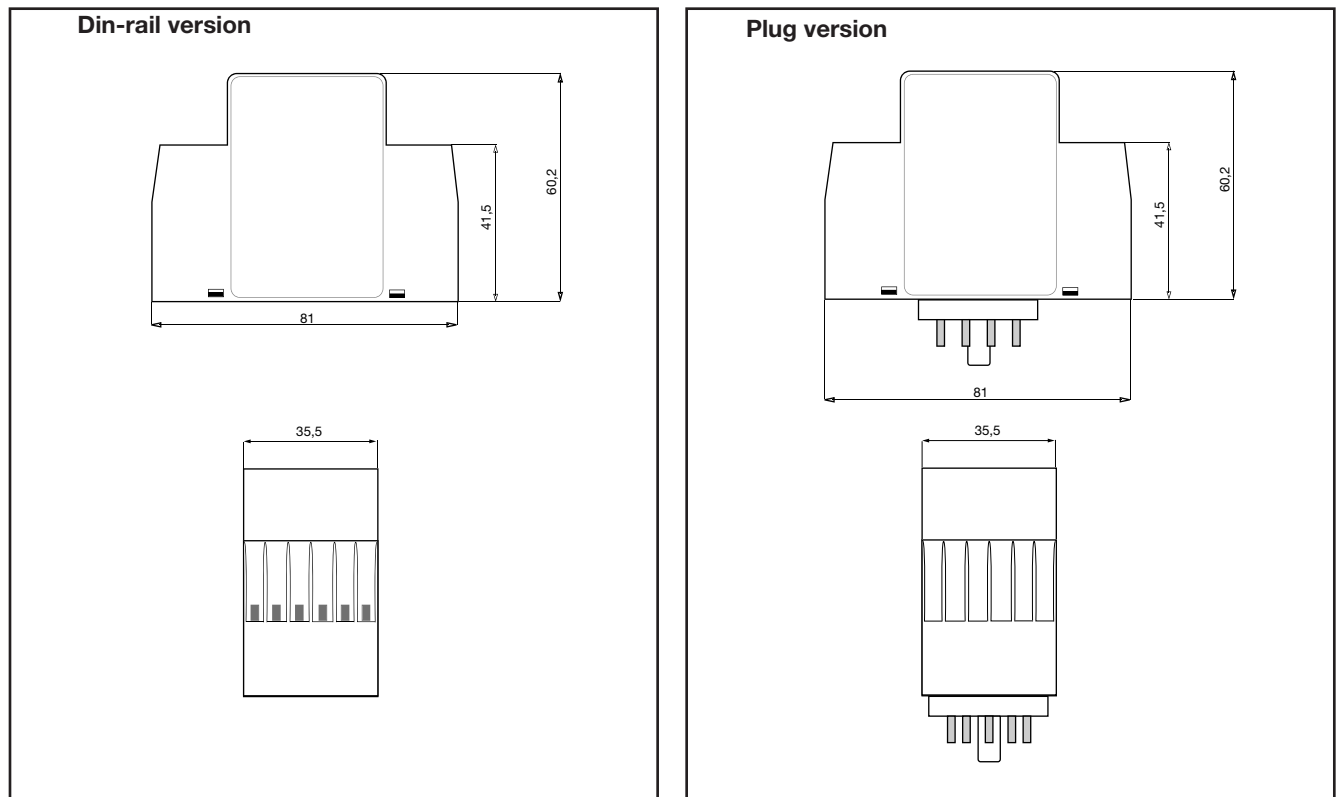

## Accessories

- 11 pole circular socket ZPD11
- Retaining spring HF

## Delivery Contents

- Amplifier
- Packaging: Carton box
- Manual

## X-ON Electronics

Largest Supplier of Electrical and Electronic Components

*Click to view similar products for [Liquid Level Sensors](#) category:*

*Click to view products by [Carlo Gavazzi](#) manufacturer:*

Other Similar products are found below :

[FSH-21](#) [FSH-25](#) [FSH-34](#) [FSH-35](#) [FSV-31](#) [FSV-35](#) [RSF54H100R1/8](#) [LRNH31S41](#) [F03-16SFC-10M](#) [F03-16SF-5M](#) [F03-16PE-5M](#) [F03-16PT-5M](#) [LBFS 1151](#) [SCN-1518SC](#) [LL103000](#) [LRNR31N01](#) [MS03-PP](#) [F03-16SF-10M](#) [KSL-100-1](#) [LS01-1B66-PP-500W](#) [LS02-1B66-S-500W](#) [LS02-1B85-PP-5000W](#) [LS03-1A85-PP-500W](#) [LRNH31S42](#) [59630-1-T-02-F](#) [LS04-1B66-2-500W](#) [LFFS 011](#) [T0-SKF-0.5](#) [T0-SKF-10](#) [T0-SKF-5](#) [VNI3](#) [CLP2FA1BM24](#) [VNI1](#) [LBFS 0111](#) [LFFS 014](#) [KSL-88-PP](#) [KSL-99-1](#) [LS02-1A85-PP-500W](#) [LS02-1B85-PP-500W](#) [LS03-1A85-PA-500W](#) [MIC 1000-20](#) [700670](#) [BAF147B002-00A0](#) [DFT-110](#) [DFT-220](#) [A94-10](#) [CA30CLL30BP](#) [CA30CLL30BPM1](#) [CLE1](#) [CLE1K](#)