

Timers Multifunction Types DMB01, PMB01

CARLO GAVAZZI



DMB 01



PMB 01

- Time range 0.1 s to 100 h
- 7 knob selectable functions:
 - Op - delay on operate
 - In - interval
 - Io - interval on trigger open
 - Id - double interval
 - Dr - delay on release
 - R - symmetrical recycler ON first
 - Rb - symmetrical recycler OFF first
- Knob selection of time range
- Knob-adjustable time setting
- Automatic or manual start
- Repeatability: $\leq 0.2\%$
- Output: 8 A SPDT or 8 A DPDT relay
- For mounting on DIN-rail in accordance with DIN/EN 50 022 or Plug-in
- 22.5 mm Euronorm or 36 mm Plug-in module housing
- Combined AC and DC power supply
- LED indication for relay status and power supply ON

Product Description

Multi-voltage timer with 7 knob selectable functions and 7 knob selectable time ranges within 0.1s and 100h. For mounting on DIN-rail (DMB01) or Plug-in (PMB01).

Ordering Key

DMB 01 C M24

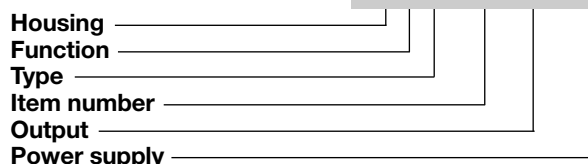

Type Selection

Mounting	Output	Housing	Supply: 24 VDC and 24 to 240 VAC	Supply: 24 to 240 VAC/DC
DIN-rail	SPDT DPDT	D-Housing	DMB 01 C M24	DMB 01 D M24
Plug-in	SPDT DPDT	P-Housing	PMB 01 C M24	PMB 01 D M24

Time Specifications

Time ranges Knob Selectable	0.1 to 1 s 1 to 10 s 6 to 60 s 60 to 600 s 0.1 to 1 h 1 to 10 h 10 to 100h
Setting accuracy	$\leq 5\%$
Repeatability	$\leq 0.2\%$
Time variation Within rated power supply Within ambient temperature	$\leq 0.05\%/V$ $\leq 0.2\%/^{\circ}C$
Reset Manual reset of time and/or relay	Close the trigger contact between pins A1 and Y1 or 2 and 5
Pulse duration Power supply interruption	≥ 100 ms ≥ 200 ms
Automatic start	Connect pins A1 and Y1 or 2 and 5

Output Specifications

Output	SPDT or DPDT relay
Rated insulation voltage	250 VAC (rms)
Contact Ratings (AgSnO₂)	μ
Resistive loads	AC 1 8 A @ 250 VAC DC 12 5 A @ 24 VDC
Small inductive loads	AC 15 2.5 A @ 250 VAC DC 13 2.5 A @ 24 VDC
Mechanical life	$\geq 30 \times 10^6$ operations
Electrical life	$\geq 10^5$ operations (at 8 A, 250 V, $\cos \varphi = 1$)
Operating frequency	< 7200 operations/h
Dielectric strength	
Dielectric voltage	2 kVAC (rms)
Rated impulse withstand volt.	4 kV (1.2/50 μ s)

Supply Specifications

Power supply	Overvoltage cat. III (IEC 60664, IEC 60038)
Rated operational voltage through terminals: (DMB01C) A1, A2 (PMB01C) 2, 10	24 VDC \pm 15% and 24 to 240 VAC
(DMB01D) A1, A2 (PMB01D) 2, 10	+10%/-15%, 45 to 65 Hz 24 to 240 VAC/DC +10%/-15%, 45 to 65 Hz
Voltage interruption	\leq 10 ms
Rated operational power	
AC supply	4 VA
DC supply	1.5 W

Function and Time Setting

Upper knob: Setting of function: Op - delay on operate In - interval Io - interval on trigger open Id - double interval Dr - delay on release R - symmetrical recycler (ON first) Rb - symmetrical recycler (OFF first)	Centre knob: Time setting on relative scale: 1 to 10 with respect to the chosen range. Lower knob: Setting of time range.
--	--

Mode of Operation

Function Op

Delay on operate

The time period begins as soon as the trigger contact is closed.

At the end of the set delay time the relay operates and doesn't release until the trigger contact is closed again or the power supply is disconnected. If the trigger contact is closed before the end of the delay time, the device resets and a new time period starts.

Function In

Interval

The relay operates and the time period begins as soon as the trigger contact is closed. The relay releases at the end of this period or when the power supply is disconnected. The relay operates again when the trigger contact is closed again. If the trigger contact is closed before the end of the delay time, the relay

keeps ON and a new time period starts.

Function Io

Interval on trigger open

The relay operates and the time period begins as soon as the trigger contact is opened. At the end of the set delay or when the power supply is disconnected the relay releases. The relay operates again when the trigger contact is opened again. If the trigger contact is opened before the end of the delay time the relay keeps ON and a new time period begins.

Function Id

Double interval

The relay operates and the time period begins as soon as the trigger contact is closed. The relay releases at the end of this period or when the power supply is disconnected. When the trigger contact is opened

General Specifications

Power ON delay	\leq 100 ms
Indication for Power supply ON Output relays ON	LED, green LED, yellow (flashing when timing)
Environment Degree of protection Pollution degree	(EN 60529) IP 20 3 (DMB01), 2 (PMB01) (IEC 60664)
Operating temperature Storage temperature	-20 to 60°C, R.H. < 95% -30 to 80°C, R.H. < 95%
Housing Dimensions	DMB01 22.5 x 80 x 99.5 mm PMB01 36 x 80 x 94 mm
Weight	Approx. 130 g
Screw terminals Tightening torque	Max. 0.5 Nm according to IEC EN 60947
Approvals	UL, CSA RINA (DMB01 only)
CE Marking	Yes
EMC Immunity Emission	Electromagnetic Compatibility According to EN 61000-6-2 According to EN 61000-6-3
Timer Specifications	According to EN 61812-1

the relay operates again for the set delay period. If the trigger contact is opened before the end of the first time period the second one begins; if the trigger contact is closed before the end of the second time period the relay keeps ON and the first time period begins again.

Function Dr

Delay on release

The relay operates as soon as the trigger contact is closed. The time period begins when the trigger contact is opened. The relay releases at the end of the set delay time or when the power supply is disconnected. The relay operates again when the input contact is closed again. If it is closed before the end of the delay time the relay keeps ON, a new time period begins as soon as the contact is opened again.

Function R

Symmetrical recycler, ON-time period first

The relay operates and the time period begins as soon as the input contact is closed. After the set delay period the relay releases for the same time period. This sequence continues with equal ON- and OFF-time periods until the power supply is interrupted.

Function Rb

Symmetrical recycler, OFF-time period first

The time period begins as soon as the input contact is closed. The relay is OFF during the set delay period, after this time it operates for the same time period. This sequence continues with equal OFF- and ON-time periods until power supply is interrupted.

Mode of Operation (cont.)

Additional Load
It's possible to wire an additional load (i.e. a relay) between pins Y1 and A2, or 5 and 10, driven by the trig-

ger contact without damaging the device (see wiring diagram).

Yellow LED working mode
Timing: Slow blinking
Relay ON: See operation diagrams

Incorrect knobs position:
Fast blinking

Operation Diagrams

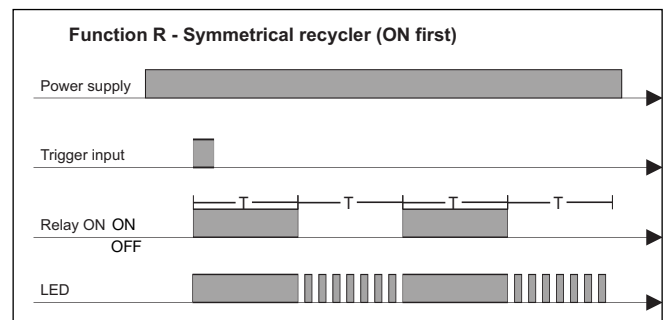
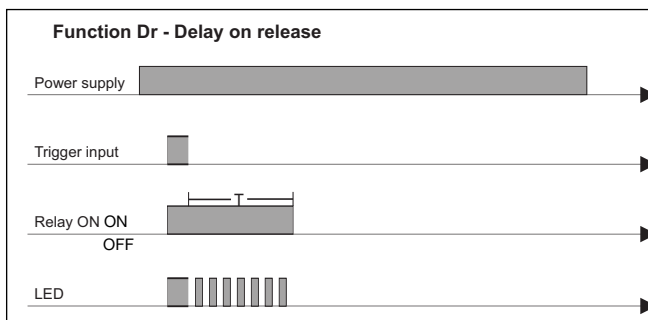
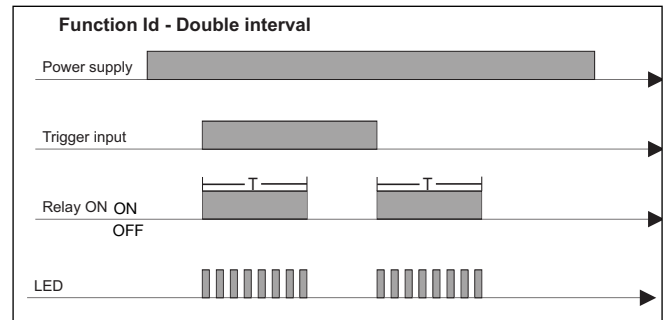
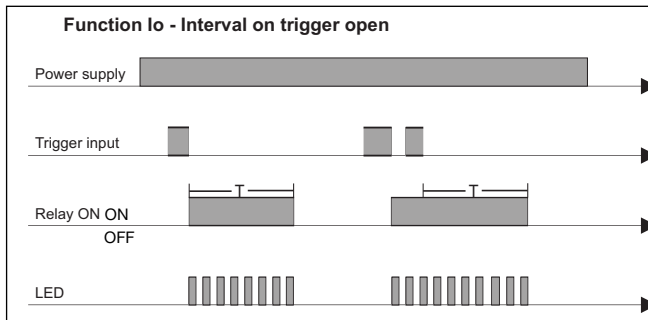
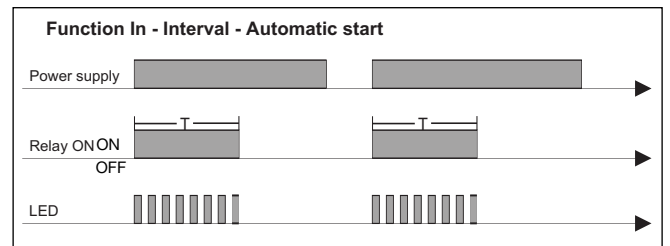
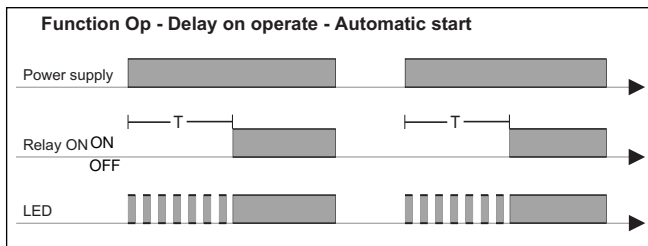
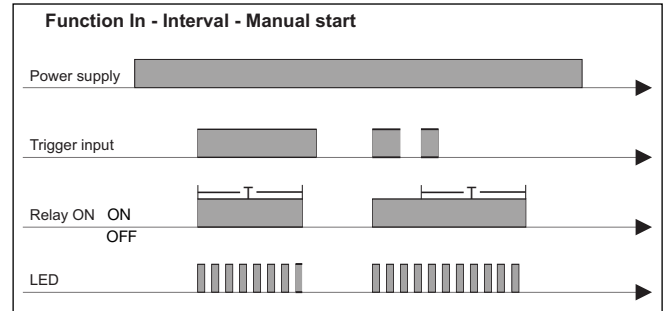
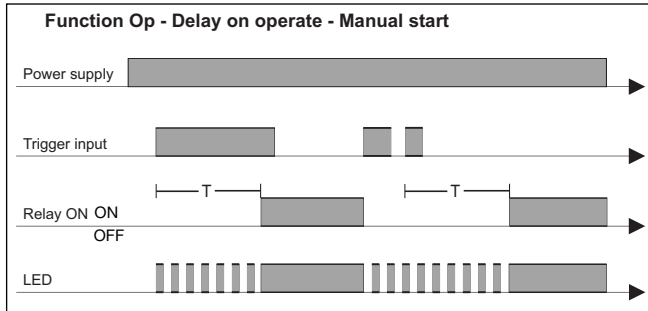

Operation Diagrams (cont.)

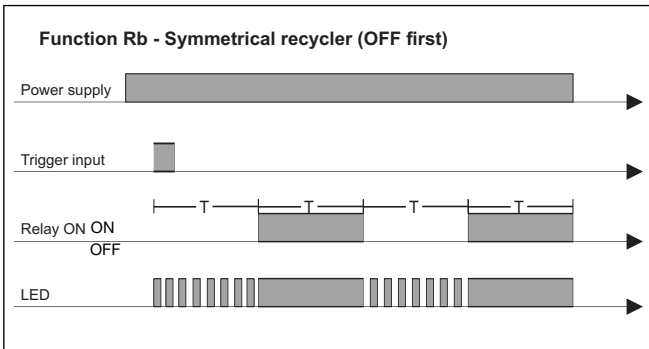

Wiring Diagrams

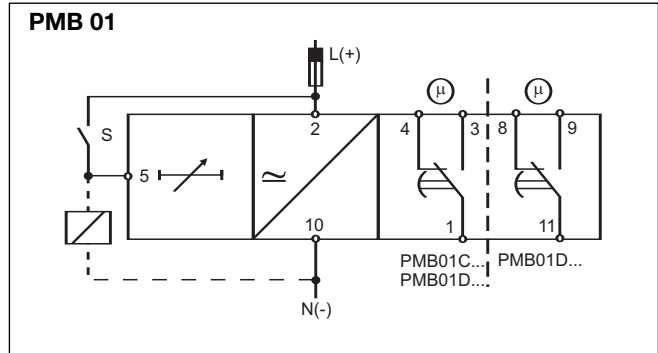
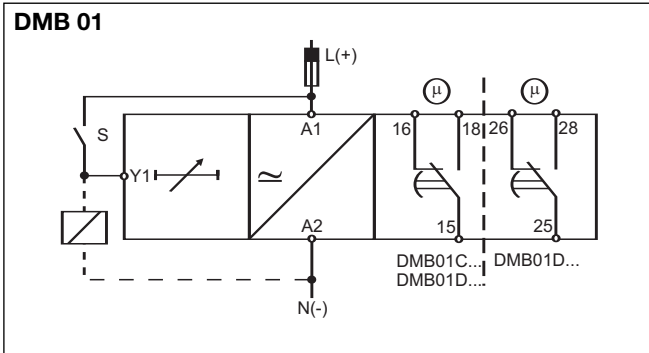

Dimensions

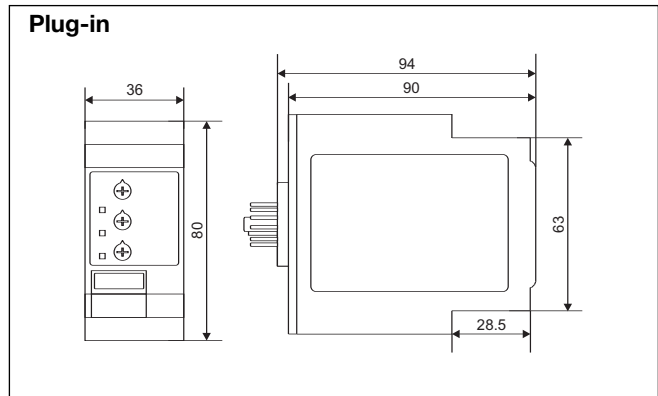
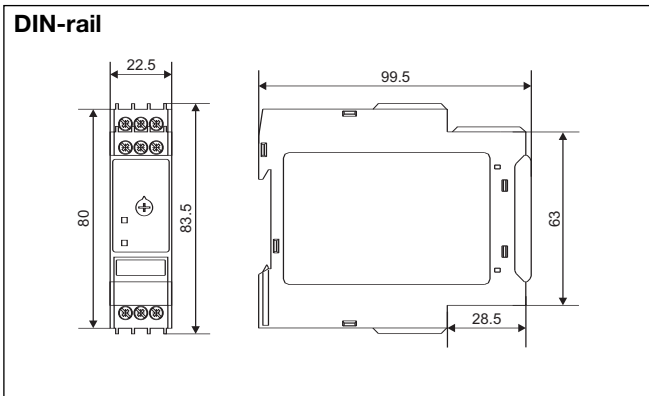

X-ON Electronics

Largest Supplier of Electrical and Electronic Components

Click to view similar products for [Time Delay & Timing Relays](#) category:

Click to view products by [Carlo Gavazzi](#) manufacturer:

Other Similar products are found below :

[5NO30](#) [614-11B-0A2](#) [614-11B-0A3](#) [614-11B-0A4](#) [614-11B-0A6](#) [614-11B-0A8](#) [614-11C-0A1](#) [614-11C-0A2](#) [614-11C-0A5](#) [614-11Q-0A3](#) [614-11Q-0A6](#) [614-11T-0A3](#) [614-11T-0A6](#) [614-11T-0A7](#) [614-12B-4A1](#) [614-12C-400](#) [614-12Q-400](#) [614-12T-600](#) [614-22T-4A1](#) [614-43B-400](#) [614-43C-100](#) [614-43F-200](#) [614-43Q-0A2](#) [614-43Q-100](#) [614-43Q-600](#) [614-43T-0A9](#) [614-43T-600](#) [614-43U-400](#) [614-43U-4A1](#) [614-43U-6A2](#) [615-21T-200](#) [655-11T-100](#) [655-11U-500](#) [655-12T-300](#) [655-22T-400](#) [655-22T-600](#) [CUA-41-30001](#) [CUA-41-30030](#) [CUA-41-70180](#) [CUA-41-71038](#) [CUA-42-30005](#) [CUA-42-30010](#) [CUA-42-30120](#) [CUA-42-70120](#) [CUA-99-72502](#) [CUC-41-30030](#) [CUF-42-30010](#) [CUH-41-31006](#) [7012AFX](#) [7012GD](#)