

3-phase Voltage and Frequency Monitoring with NFC



Benefits

- **Flexibility and Versatility.** 2 part numbers cover all requirements in terms of mains type, voltage and frequency values.
- **2 SPDT outputs.** It is possible to provide 2 different signals for different purposes.
- **Plug & Play.** DPD is available with 2 different factory settings. Which are the most commonly used.
- **Customized devices availability.** DPD can be ordered with customized settings also for very small quantities.
- **NFC Communication.** Through the NFC communication, via smartphone, tablet or PC, the DPD can be configured or provide real time operation data such as: alarms status, voltage & frequency readings.
- **High Compactness.** The DPD features a large amount of capabilities in just 22.5 mm.

Description

DPD is a threephase multifunction configurable monitoring relay suitable for both Delta and Star mains. It protects loads from wrong phase sequence, neutral and phase loss, additionally voltage, frequency and asymmetry thresholds can be set and provide output signals.

The DPD is delivered with factory default alarm values, if they are not completely suitable they can be modified according to own requirements.

DPD has two separate relay outputs.

3 front LEDs provide visual indication of outputs states and alarm discrimination.

Through the DPD APP the user can reprogram the unit at any time or check the device operation status.

Applications

DPD is suitable for all applications where it is necessary to monitor phase presence, correct phase sequence and the voltage, frequency and quality of threephase load mains: lifts, escalators, HVAC, material handling, pumps and compressors.

Main functions

- 3Ph or 3Ph+N monitoring
- From 177V to 552V LL or 102V to 318V LN
- Operating frequency from 45 to 440Hz
- Phase sequence and phase or neutral loss alarm

- Configurable voltage, frequency and asymmetry alarms
- Up to 10 alarms combinable with and / or operators
- NFC Interface

Structure

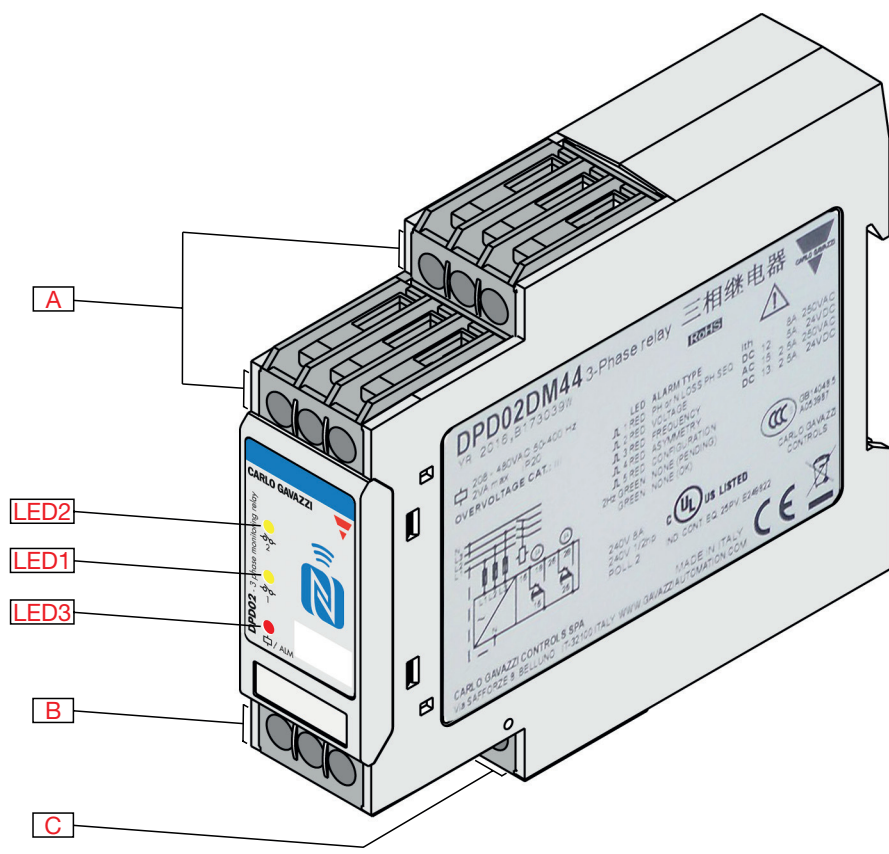

Element	Component	Function
A	Power supply terminals	L1, L2, L3 and N supply and measuring terminals
B	Output2 terminals	Output relay 2 contacts terminals: COM, NO and NC
C	Output1 terminals	Output relay 1 contacts terminals: COM, NO and NC
LED1	Output led	This LED is lit when Output 1 is energized
LED2	Output led	This LED is lit when Output 2 is energized
LED3	Alarm led	LED3 is bicolour and can be blinking or fixed: Green On fixed: ok Green Flashing: alarm triggered but configured delay is elapsing 1 red flash: phase or neutral Loss or phase sequence 2 red flashes: under or over voltage 3 red flashes: under or over frequency 4 red flashes: asymmetry 5 Flashes: out of range parameter

Features

General

Material	PA66 or Nylon
Assembly	DIN rail mounting (According to EN 50022)
Protection grade	IP20
Weight	120g
Terminals	Screw terminals. AWG30 to AWG14 (0.06 mm ² to 2.1 mm ²) stranded or solid

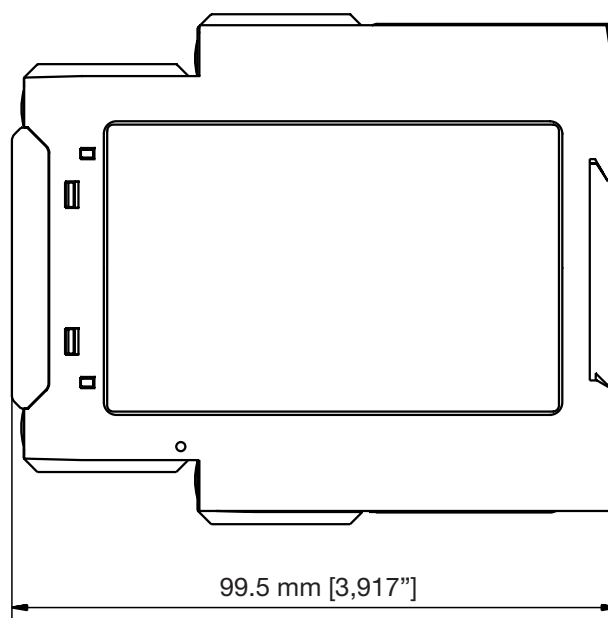
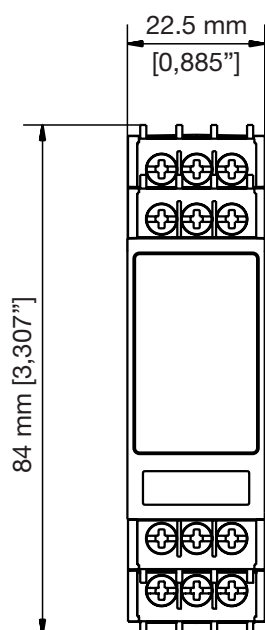

Power Supply

Power supply	Voltage range: 166 V to 576 V (208 V -20% to 480 V +20%) line to line voltage Frequency range: 45 Hz to 440 Hz (50 Hz -10% to 400 Hz +10%) sinusoidal waveform
Consumption	< 3 VA
Power ON Delay	Configurable from 0 to 6 s (default 0 s)

Environmental

Working temperature	-20° C to 60° C (-4° F to 140° F)
Storage temperature	-30° C to 80° C (-22° F to 176° F)
Relative humidity	5-95% non condensing
Pollution degree	2
Operating max altitude	2000m
Salinity	No saline environment
UV resistance	No UV exposure



Vibration/Shock resistance	
Tests with the device outside the box: Vibration response (IEC60255-21-1) Vibration endurance (IEC 60255-21-1) Shock (IEC 60255-21-2) Bump (IEC 60255-21-2)	Class1 Class1 Class1 Class1
Tests with the device inside the box: Vibration, random (IEC60068-2-64) Shock (IEC 60255-21-2) Bump (IEC 60255-21-2)	Class1 Class1 Class1

Note:

Class 1: normal use in industrial plants, normal transportation condition.

► Compatibility and conformity

Approvals	   
CE Marking	LV directive, EMC directive EN 60947-5-1

► Inputs

Measuring ranges	
Variable measuring	Voltage 3PH (Delta) or 3PH+N (Star) line measurement on L1, L2, L3 and N lines Frequency 3PH (Delta) or 3PH+N (Star) line measurement on L1, L2, L3 and N lines Asymmetry measurement on L1, L2, L3 and N lines Phase loss Neutral loss Phase sequence Out range measurement Out of bounds parameter

Voltage measurement	
Typology	3PH (Delta) or 3PH+N (Star) line voltage measurement on L1, L2, L3 and N lines
Nominal Range for Line 3PH (Delta)	177 V to 552 V (delta voltage 208 V-15% to 480 V+15%)
Nominal Range for Line 3PH+N (Star)	102 V to 318 V (star voltage 120 V-15% to 277 V+15%)
Adjustable Threshold range	3PH (Delta) 177 VAC to 552 VAC, 3PH+N (Star) 102 VAC to 318 VAC
Adjustable Hysteresys	From 2% to 5%
Delay ON	From 0 s (<200 ms) to 60 s
Delay OFF	0 s (<200 ms) to 60 s
Resolution	1 V
Accuracy	1% reading +1 V
Refresh time	According to alarms response time



Frequency measurement	
Typology	3PH (Delta) or 3PH+N (Star) line frequency measurement on L1, L2, L3 and N lines
Adjustable threshold range	From 45 Hz to 440 Hz
Adjustable hysteresys	From 2% to 5%
Delay ON	From 0 s (<200 ms) to 60 s
Delay OFF	
Resolution	0.5 Hz
Accuracy	1% reading
Refresh time	According to alarms response time

Asymmetry measurement	
Typology	3PH (Delta) or 3PH+N (Star) line asymmetry measurement on L1, L2, L3 and N lines
Adjustable threshold range	From 0% to 30%
Adjustable hysteresys	From 2% to 5%
Delay ON	From 0 s (<200 ms) to 60 s
Delay OFF	
Resolution	Compatible with direct measurements
Accuracy	
Refresh time	Compatible with alarm delay time

Non priority alarms (up to 10 configurable alarms)	
Input variables	Over-voltage, under-voltage, over-frequency, under-frequency, asymmetry
Reaction time	≤ 200 ms

Phase loss priority alarm	
Input variables	L1-L2, L2-L3 and L3-L1 Voltage measurements
Adjustable threshold range	From 60% to 90%
Reaction time	≤ 200 ms
Hysteresis	From 2% to 5%
Delay ON	From 0 s (<200 ms) to 60 s
Delay OFF	

Neutral loss priority alarm	
Input variables	L1-N, L2-N and L3-N Voltage measurements.
Adjustable threshold range	From 10% to 30% of LN voltage.
Reaction time	≤ 200ms
Adjustable hysteresys	From 2% to 5%
Delay ON	From 0s (<200ms) to 60s
Delay OFF	

Phase sequence priority alarm	
Input variables	Connection L1, L2, L3, N
Range	No setting necessary
Reaction time	≤ 200 ms
Hysteresis	None
Delay ON	
Delay OFF	

Measure out of range priority alarm	
Input variables	Measure voltage, frequency, asymmetry
Range	No setting necessary
Reaction time	≤ 200 ms
Hysteresis	None
Delay ON	
Delay OFF	

Outputs

Type	2 x SPDT electromechanical relay with change-over contacts
Logic	Priority alarms: Output 1 De-Energized on Alarm Output 2 De-Energized on Alarm Non Priority Alarms: Output 1 N.E. or N.D. according to Configuration (Default N.E.) Output 2 N.E. or N.D. According to Configuration (Deafult N.E.) N.E. = Normally Energized N.D. = Normally De-Energized
Contact rating	AC1: 8A @ 250 VAC DC12: 5 A @ 24 VDC AC15: 2.5 A @ 250 VAC DC13: 2.5 A @ 24 VDC

Insulation

Terminals	Basic Insulation
Inputs: L1,L2,L3,N to Output 1: 15,16,18	2.5KVrms, 4KV impulse 1.2/50us (basic)
Inputs: L1,L2,L3,N to Output 2: 25,26,28	2.5KVrms, 4KV impulse 1.2/50us (basic)
Output 1: 15,16,18 to Output 2: 25,26,28	2.5KVrms, 4KV impulse 1.2/50us (basic)

Operating Description

• Suitability

DPD can be used for power supply and mains quality monitoring of all threephase loads with supply voltage from 102VAC to 552VAC. Monitoring function can be performed between Line to Line as well as Line to Neutral.

• Alarms

There are 2 types of alarms for the DPD: the "priority" alarms and the "non priority" alarms. Priority alarms De-Energize both outputs at the same time when they are triggered:

- Phase loss
- Neutral loss (only in "Star" configured systems)
- Wrong phase sequence
- Out of range measurement

Each one of the priority alarm can be disabled individually. The threshold can be set for the phase or neutral loss.

Non priority alarms are totally configurable by user. Type of measurement to be monitored and trigger value can be freely set, within the specified ranges, and changed any time:

- Undervoltage U<
- Overvoltage U>
- Overfrequency f>
- Underfrequency f<
- Threephase asymmetry

Up to 10 virtual alarms among the above types can be configured. As there are only 2 outputs on the DPD, certain alarms can be configured without being directly associated to an output.

- **Delays**

For each one of the Alarms it is possible to set an "Alarm ON" from 0 (the device reaction time is though <0.2 s) to 60 s. If the alarm cause restores before alarm ON delay elapsing no output signal will be provided. Alarm OFF delay can be set from 0 s to 600 s.

Delays are only applicable for non priority alarms. Priority alarms are always immediate.

- **Outputs**

There are 2 SPDT Electromechanical outputs which can be associated to any of the alarms set. It is also possible to associate 2 or more alarm by means of AND or OR operators to a specific output.

Each one of the outputs can be configured as "Normally Energized" or "Normally De-Energized".

- **Visual information**

The DPD is equipped with 3 LEDs which provide the status information

- LED1 is lit when the Output 1 is energized
- LED2 is lit when the Output 2 is energized
- LED3 is bicolor and can be blinking or fixed

LED3 key:

LED3	Status
Green On fixed	OK
Green Flashing	Alarm triggered but configured delay is elapsing
1 red flash	Phase or neutral Loss or phase sequence
2 red flashes	Under/over-voltage
3 red flashes	Under/over-frequency
4 red flashes	Asymmetry
5 Flashes	Out of range parameter

- **NFC communication**

DPD is equipped with built-in NFC communication.

With the DPD APP through the NFC communication it is possible to read or write the device configuration as well as reading the voltage, the frequency or the alarms in real time.

NFC communication does not require any power for the device configuration.

DPDs can be configured without taking them out of the box.

Configuration

The configuration can be prepared on the PC or smartphone, downloaded from another device, by means of NFC, or picked from file.

Once a configuration has been prepared on the PC it can be uploaded to one of more DPDs.

NFC also allows, when necessary to download the configuration from a device, modify it if necessary and then upload it to another device.

It is possible to Lock the DPD in order to avoid tampering or unauthorized configuration. The locking/ unlocking procedure is managed through one of the available apps.

- **Operation flow**

When powered, after Power On delay elapsing, until mains parameters are within all the alarms threshold values, the DPD LED3 will be lit green (steady).

If one of the mains parameters is exceeded the alarm ON delay elapsing starts, LED3 blinks green (if a delay is set, else immediately), at the end of the delay the alarm associated output switches and LED3 flashes RED (see visual information table).

When the value, which was exceeded, returns to normal the delay OFF elapsing starts (if a delay is set, else immediately), at the end of the delay the alarm associated output switches returning to original position. LED3 returns to steady green.

• **Phase loss**

Phase loss measurement is performed by comparing the 3 phases voltage values. If the voltage of one phase falls below the set threshold, can be turned OFF if unwanted, (default is 85%), compared to the other 2 phases, the alarm goes off. DPD detects loads regenerated voltage. Setting below the default value may cause insensitivity to phase loss.

• **Neutral loss**

On Star connected loads if the neutral connection is lost the DPD detects the failure and goes into alarm. Setting the neutral loss above the default value may cause, in case of a balanced load, insensitivity to neutral loss.

This detection can be turned OFF if unwanted.

• **Asymmetry**

Asymmetry is an indicator of the mains quality, can be turned OFF if unwanted, and it is defined as the absolute value of the maximum deviation among the mains voltages, divided by the nominal voltage of the 3-phase system. The definition changes according to the voltage reference:

1) In case of measuring phase-phase voltages:

$$\frac{\max |\Delta V_{PH-PH}|}{V_{\Delta NOM}} \times 100$$

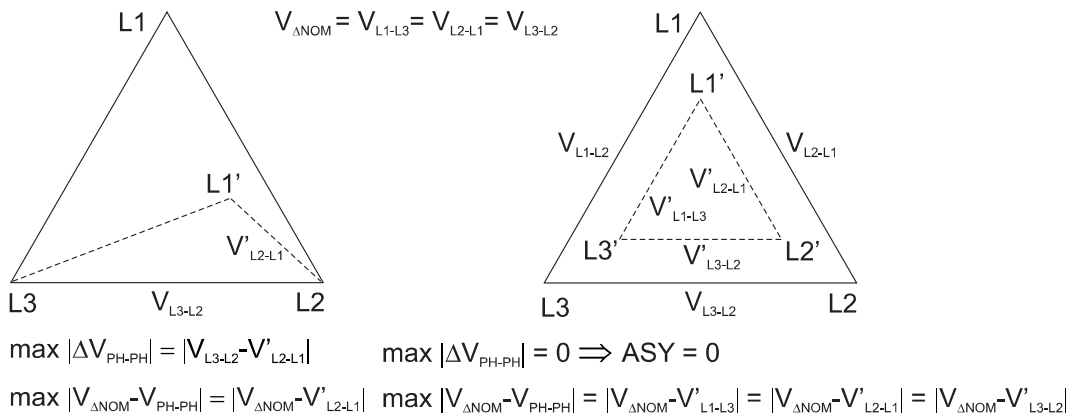

Fig. 1 Phase-phase monitoring

2) In case of measuring phase-neutral voltages:

$$\frac{\max |\Delta V_{PH-N}|}{V_{\lambda NOM}} \times 100$$

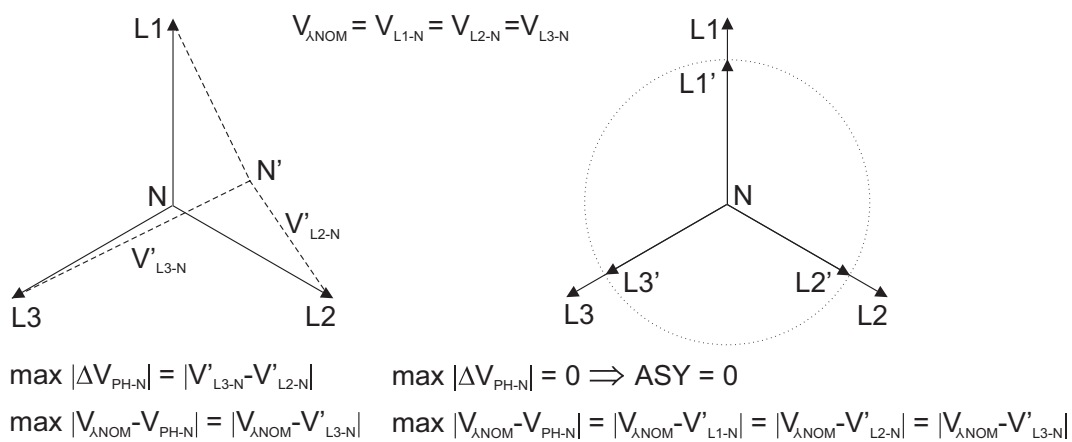
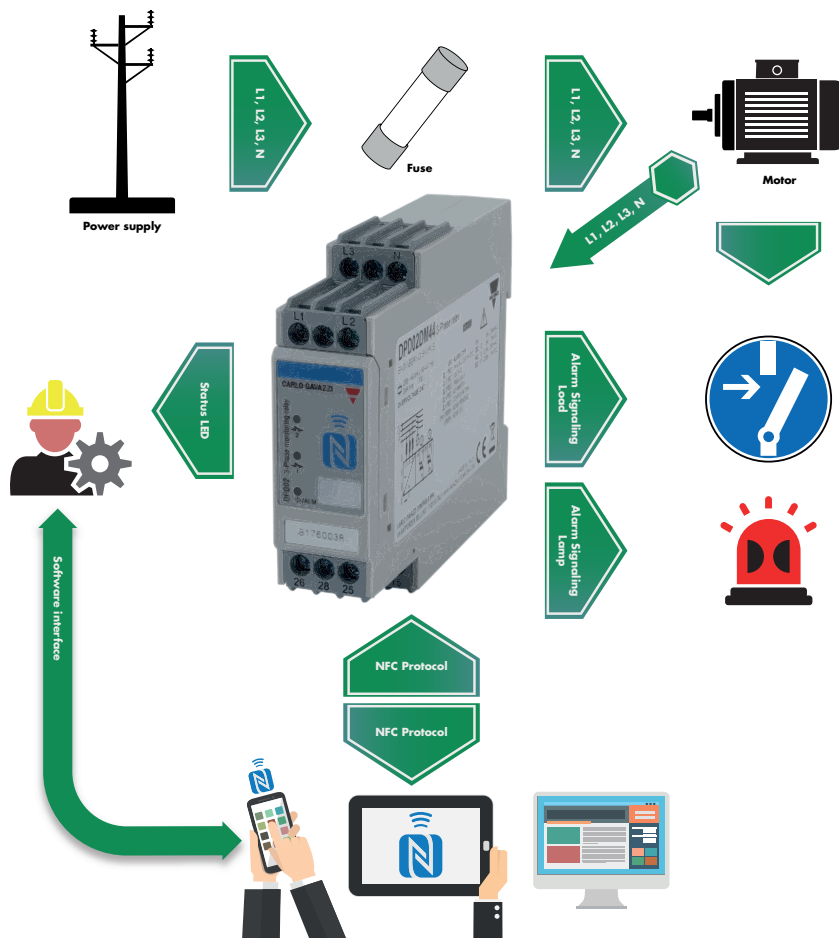
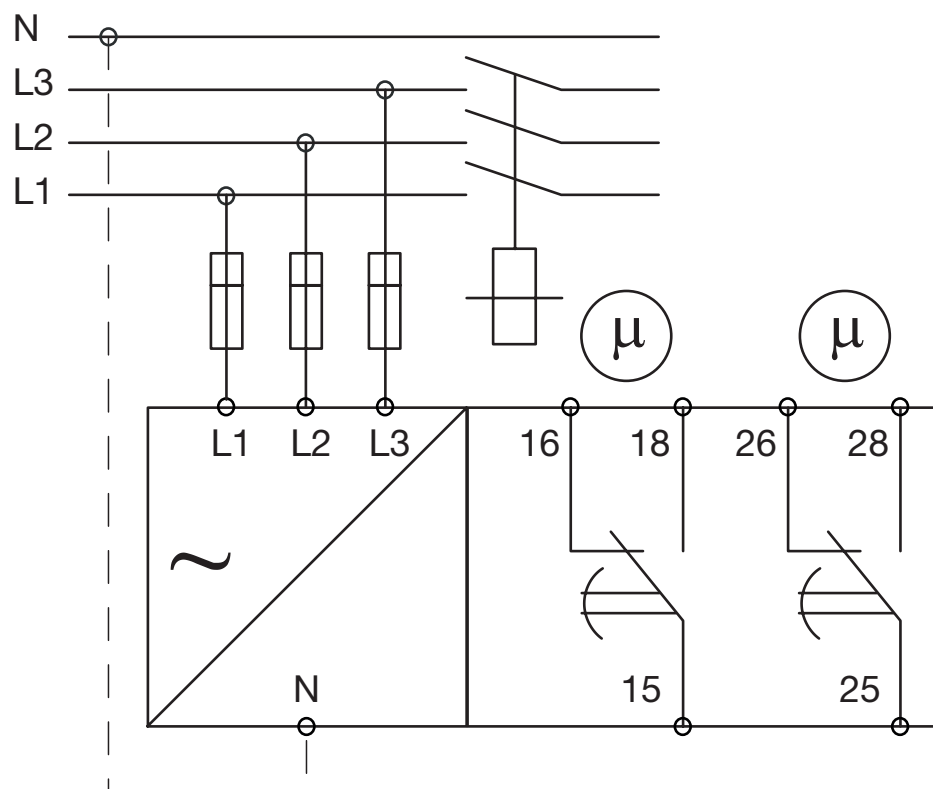

Fig. 2 Phase-neutral monitoring

▶ Motor load application block diagram





Connection Diagrams





References

Further reading

Information	Where to find it	QR
Installation manual	http://www.productselection.net/MANUALS/UK/dpd_im.pdf	
User manual	http://www.productselection.net/MANUALS/UK/dpd_um.pdf	
Google App	https://play.google.com/store/apps/details?id=us.belka.dpd&hl	
Windows desktop app	www.productselection.net/Download/UK/Setup_DPD.msi	
NFC drivers	www.productselection.net/Download/UK/ACR1252_Winx64_64bit.zip www.productselection.net/Download/UK/ACR1252_Winx86_32bit.zip	

CARLO GAVAZZI compatible components

Purpose	Component name/code	Notes
USB NFC reader / writer	ACR1252U	This accessory is necessary to interface the DPD NFC with a PC which is not equipped with NFC transmission

Ordering code

DPD02DM44 (Default 1)

DPD02DM44B (Default 2)

Country default settings

Page	Item	Part number	
		DPD02DM44	DPD02DM44B
Grid type	Line type	Delta	Delta
	Rated line voltage	400 VAC	240 VAC
	Power ON delay	0 s	0 s
Setpoints	Alarm 1	Overvoltage	Overvoltage
	Voltage Value	440 VAC	264 VAC
	Hysteresys	2%	2%
	Delay ON	0 s	0 s
	Delay OFF	0 s	0 s
	Alarm 2	Undervoltage	Undervoltage
	Voltage Value	360 VAC	216 VAC
	Hysteresys	2%	2%
	Delay ON	0 s	0 s
	Delay OFF	0 s	0 s
Priority alarms	Phase loss enable	ON	ON
	Phase loss threshold	85%	85%
	Neutral loss	Not active	Not active
	Phase sequence enable	ON	ON
	Out of range measurement	ON	ON
Output 1	Assignment	Alarm 1	Alarm 1
	Logic	Normally energized	Normally energized
	Logic operators	None	None
Output 2	Assignment	Alarm 2	Alarm 2
	Logic	Normally energized	Normally energized
	Logic operators	None	None

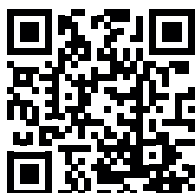

COPYRIGHT ©2017
Content subject to change. Download the PDF: www.productselection.net

X-ON Electronics

Largest Supplier of Electrical and Electronic Components

Click to view similar products for [Industrial Relays](#) category:

Click to view products by [Carlo Gavazzi](#) manufacturer:

Other Similar products are found below :

[6-1617801-8](#) [6-1618107-9](#) [7-1618273-3](#) [EV250-4A-02](#) [EV250-6A-01](#) [FCA-125-CX8](#) [FCA-325-159](#) [FCA-410-138](#) [8000-S3121](#) [8-1618273-6](#)
[8-1618393-1](#) [GCA63A220VAC60HZ](#) [GCA63A277VAC60HZ](#) [GCA63A600VAC60HZ](#) [1-1672275-3](#) [1-1833005-4](#) [H-16/S1](#) [A711Z](#)
[ACC530U20](#) [ACC633U30](#) [ACC730U30](#) [DH18DA](#) [1423675-8](#) [AVR907](#) [15732A200](#) [B07B032AC1-0329](#) [B329](#) [B490A](#) [1618279-1](#)
[BHR124Y](#) [1810DDB-SX](#) [N417](#) [P30C42A12D1-120](#) [2-1617748-6](#) [2-1618396-6](#) [2-1618398-1](#) [JMGACD-5M](#) [JMGSC-5LW](#) [JMGSCD-5L](#)
[PBO-18A1218](#) [PBO-40A3040](#) [K8DSPH1200480VAC](#) [KA-3C-12A](#) [RT334012WG](#) [S160156115](#) [SAH159](#) [2944795](#) [301-17SX](#) [1618105-2](#)
[1618112-6](#)