

# EM24



## Energy analyzer for three-phase systems



### Description

Three-phase energy analyzer for DIN-rail mounting with configuration joystick, frontal selector and LCD display. Direct connection up to 65A or via current and voltage transformers. It can be equipped with 2 digital outputs (pulse transmission or alarm function). In alternative the Modbus RTU or Dupline communication port and 3 digital inputs, the M-Bus communication, or the Modbus TCP/IP Ethernet ports are available.

The wireless M-Bus version is the perfect solution when cabling is not possible.

### Benefits

- **Time saving set-up**, by frontal joystick and selector.
- **Error-proof installation**, by self-power supply and phase sequence detection.
- **Easy variable scrolling**, by means of the front joystick.
- **Wide interfacing capability**, choosing among 2 pulse outputs, the RS485, the M-Bus, Dupline or the Ethernet communication port.
- **Extended energy measurements**, using total/partial or total/multi-tariff metering.
- **Flexible installation**, by means of the direct connection up to 65 A or the connection of 5 A current transformers.
- **Extended alarm control** on any available variable by means of up to two digital outputs.
- **Accurate measurement**. It is compliant with the international accuracy standard IEC/EN62053-21, and the IEC/EN61557-12 performance requirements (active power and active energy).
- **Legal metrology**, guaranteed by the MID approval
- **Wireless communication**, wireless M-Bus version allows remote data collection when cabling is not possible due to cost or installation requirements.
- **Easy commissioning** of wireless communication thanks to the test function of the joystick and to transmission counter for diagnostics.

### Applications

EM24 is the perfect solution in any application, specially in building and industrial automation where energy and main electrical variables monitoring is required.

EM24 is particularly suited for:

- energy efficiency monitoring
- cost allocation
- fiscal/legal sub-billing, where the wireless M-Bus version is the best choice for quick and easy installation without cables. Encryption ensures data security and safeguards confidentiality.

### Main functions

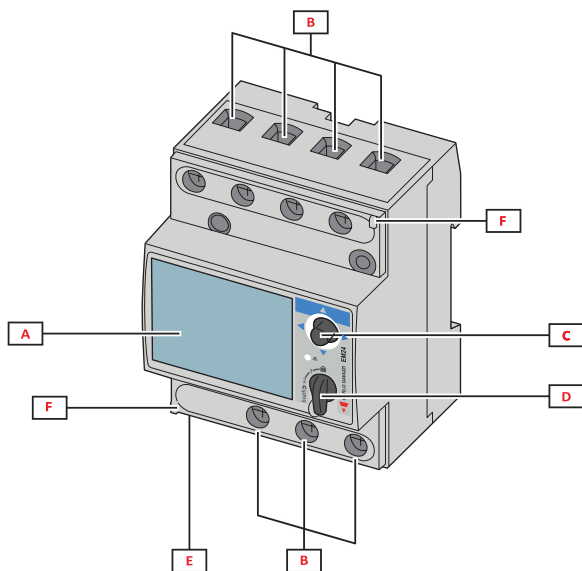
- Measurement of energy consumption and main electrical variables of single-phase, two-phase or three-phase loads.
- Display of single phase measurements and total measurements.
- Transmission of data via serial communication (Modbus RTU, M-Bus or Dupline) or Ethernet (Modbus TCP/IP).

- Transmission of energy consumption via pulse output (optional).
- Easy connection function.
- Transmission of data via wireless M-Bus (868 MHz for the European market).
- Two wireless M-Bus versions: a compact model with internal antenna and a SMA connector model with external antenna (in case of metallic switchboard).

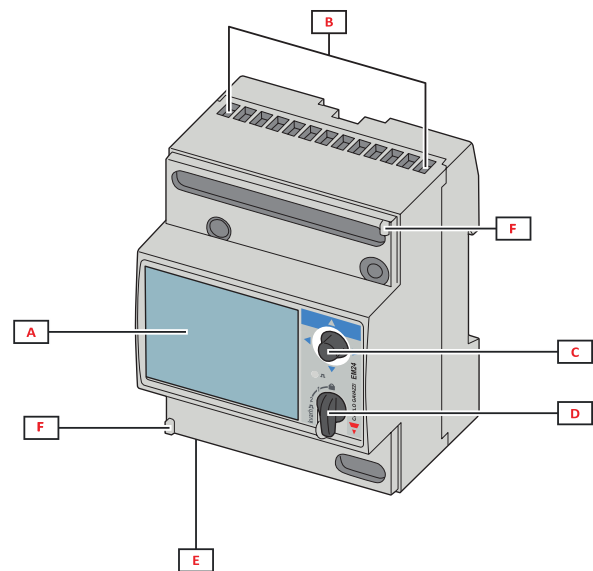
### Main features

- Energy measurements: total and partial kWh and kvarh or based on 4 different tariffs; single phase measurements
- Gas, cold water, hot water, kWh remote heating measurements via digital inputs
- TRMS measurements of distorted sine waves (voltages/currents)
- Data encryption (a unique key will be provided for any device in a sealed envelope included in the instrument box)
- Compliant with IEC/EN61557-12 performance requirements (active power and active energy)

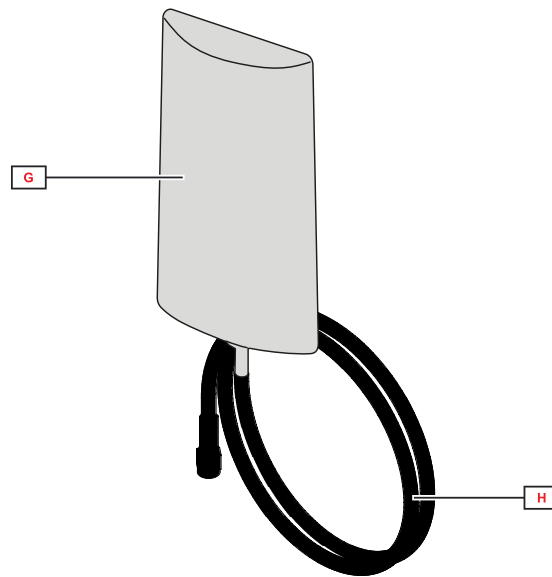
### Structure



**Fig. 1** Direct connection



**Fig. 2** CT connection



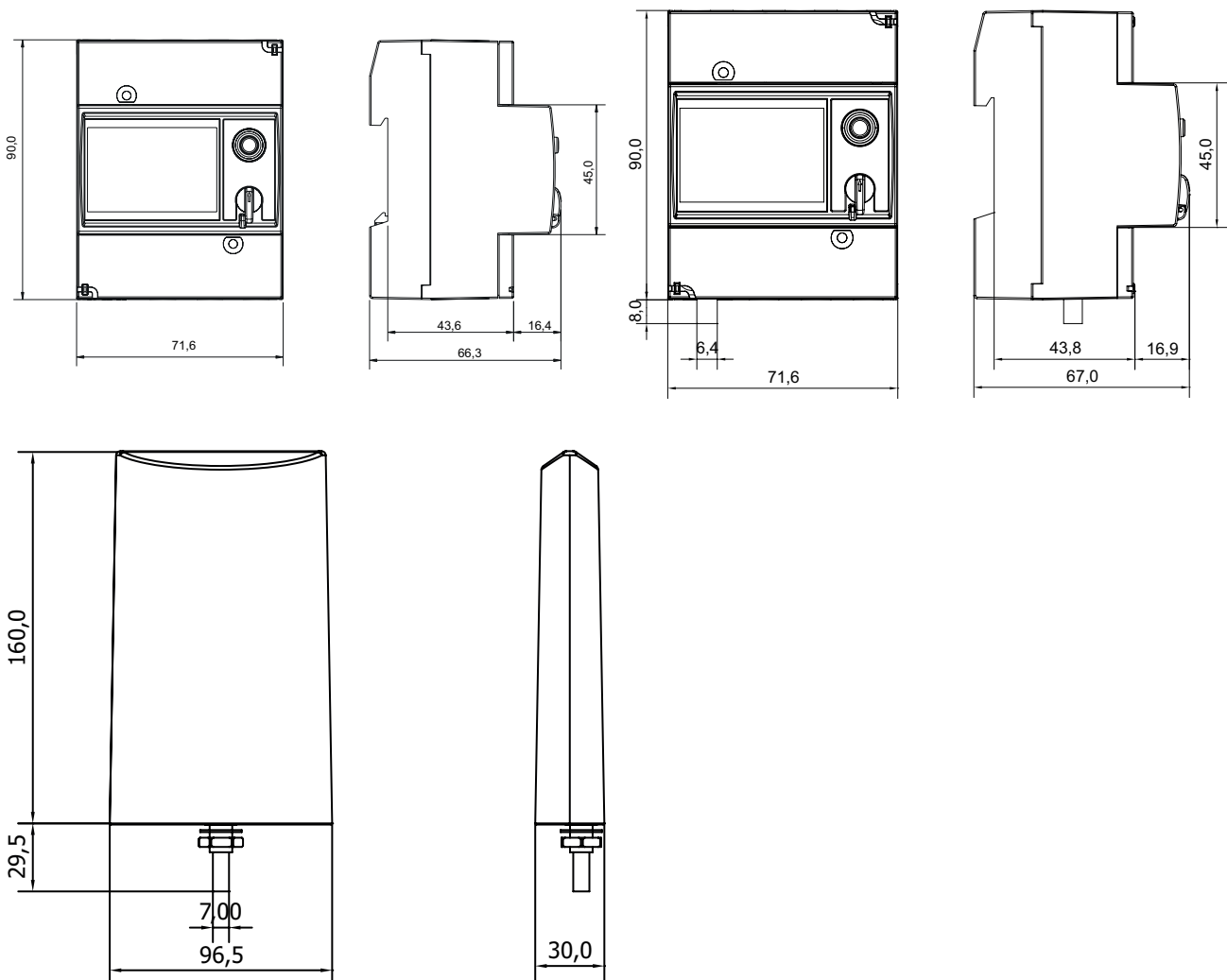
**Fig. 3** External antenna (only for EM24DINAV...W1E...)

Area	Description
A	LCD display
B	Voltage/current connections
C	Joystick
D	Selector with pin for MID seal (programming block)
E	Inputs/outputs or communication port
F	Pins for MID seal (protection covers included)
G	External antenna for wireless M-Bus communication
H	SMA connector cable (2 m)

# Features

## General

<b>Protection degree</b>	Front: IP50. Terminals: IP20
<b>Terminals</b>	Screw terminals AV2, AV9: Max.: 16 mm <sup>2</sup> , min.: 2.5 mm <sup>2</sup> (by cable lug) AV5, AV6: Max.: 1.5 mm <sup>2</sup>
<b>Overvoltage category</b>	Cat. III
<b>Utilisation category</b>	UC2
<b>Pollution degree</b>	2
<b>Noise rejection (CMRR)</b>	100 dB, from 42 to 62 Hz
<b>Mounting</b>	DIN rail
<b>Weight</b>	400 g (packaging included) 800 g with external antenna (packaging included)



## Environmental specifications



Operating temperature	From -25 to +55 °C/from -13 to +131 °F
Storage temperature	From -30 to +70 °C/from -22 to +158 °F

NOTE: R.H. < 90 % non-condensing @ 40 °C / 104 °F.

## Input and output insulation

Type	Measuring inputs	Relay outputs	Open collector outputs	Communication port and digital inputs	Dupline	Ethernet port	Self power supply	Auxiliary power supply
Measuring inputs	-	4 kV	4 kV	4 kV	4 kV	4 kV	0 kV	4 kV
Relay outputs	4 kV	-	-	-	-	-	4 kV	4 kV
Open collector outputs	4 kV	-	-	-	-	-	4 kV	4 kV
Communication port and digital inputs	4 kV	-	-	-	-	-	4 kV	4 kV
Dupline	4 kV	-	-	-	-	-	4 kV	4 kV
Ethernet port	4 kV	-	-	-	-	-	4 kV	-
Self power supply	0 kV	4 kV	4 kV	4 kV	4 kV	4 kV	-	-
Auxiliary power supply	4 kV	4 kV	4 kV	4 kV	4 kV	-	-	-

## Compatibility and conformity

Directives	2011/65/EU (RoHs), 2014/53/EU (RED)
Standards	Electromagnetic compatibility (EMC) - emissions and immunity: EN 62052-11 Electrical safety: EN 61010-1, EN 50470-1 (MID), UL 61010-1 Accuracy: EN 62053-21, EN 62053-23, EN 50470-3 (MID), IEC/EN61557-12 (active power and active energy, MID models only) Pulse outputs: IEC 62053-31, DIN 43864
Approvals	  (UL508: AV5 and AV6 except M2 and W1; UL61010-1: E1) MID (PF only)

## Electrical specifications

Voltage - MID models			
Voltage inputs	AV2	AV9	AV5
Voltage connection	Direct		
Rated voltage L-N (from Un min to Un max)	133 to 230 V	230 V	230 V
Rated voltage L-L (from Un min to Un max)	230 to 400 V	400 V	400 V
Voltage tolerance (*)	-20%, +15%		
Overload (**)	Continuous: 1.15 Un max		
Input impedance	Refer to "Power supply"		
Frequency	50 Hz		

Voltage - Non MID models (according to IEC 62052-11)					
Voltage inputs		AV2	AV9	AV5	AV6
Voltage connection		Direct			Direct or via VT
Rated voltage L-N (from Un min to Un max)	All models except E1:	133 to 230 V	230 V	230 V	57.7 to 120V
	Models: E1, W1	120 to 277 V	/	120 to 277 V	/
Rated voltage L-L (from Un min to Un max)	All models except E1:	230 to 400 V	400 V	400 V	100 to 208 V
	Models: E1, W1	208 to 480 V	/	208 to 480 V	/
Voltage tolerance (*)		-20%, +15%			
Overload (**)		Continuous: 1.15 (Un max)		Continuous: 1.2 (Un max)	
Input impedance		Refer to "Power supply"		>1600 kΩ	
Frequency		50/60 Hz			

Voltage - Non MID models (according to UL)					
Voltage inputs		AV2	AV9	AV5	AV6
Voltage connection		Direct			Direct or via VT
Rated voltage L-N (from Un min to Un max)	All models except E1, M2, W1:	/	/	230 to 346 V	57.7 to 144 V
	E1 model:	120 to 277 V	/	120 to 277 V	/
Rated voltage L-L (from Un min to Un max)	All models except E1, M2, W1:	/	/	400 to 600 V	100 to 250 V
	E1 model:	208 to 480 V	/	208 to 480 V	/
Voltage tolerance (*)		-20%, +15%			
Overload (**)		Continuous: 1.15 (Un max)			
Input impedance		Refer to "Power supply"		>1600 kΩ	
Frequency		50/60 Hz			

(\*) reference range for stated accuracy

(\*\*) max reference for no instrument damage

Current				
Current inputs	AV2	AV9	AV5	AV6
Current connection	Direct		Via CT	
Rated current (I <sub>n</sub> )	-		5 A	
Base current (I <sub>b</sub> )	10 A		-	
Minimum current (I <sub>min</sub> )	0.5 A		0.05 A	
Maximum current (I <sub>max</sub> )	65 A		10 A	
Start-up current (I <sub>st</sub> )	0.04 A		0.01 A	
Overload	Continuous: 65 A @50 Hz For 10 ms: 1950 A @50 Hz		Continuous: 10 A @50 Hz For 500 ms: 200 A @ 50 Hz	
Short circuit withstand	For 10 ms: 4500 A according to IEC 62052-31:2015		-	
Input impedance	< 1.1 VA		< 0.6 VA	
Crest factor	4 (I <sub>max</sub> peak 92 A)		3 (I <sub>max</sub> peak 15 A)	

Maximum CTxVT ratio				
Current inputs	AV2	AV9	AV5	AV6
Non-MID models except E1	-	-	4629	14529
Non-MID models: E1, W1	-	-	6975	-
MID models except E1	-	-	3150	-
MID models: E1, W1	-	-	2615	-

## Power supply

Non MID models				
	AV2	AV9	AV5	AV6
Type	Self power supply		D: 115/230 V ac, +/-15%, 50/60Hz L: 24 to 48 V ac/dc; ac: +/-15%, 50/60Hz, dc: +/-20% X (E1 only): Self power supply	
Consumption	IS and DP: < 12VA/2W E1: 4.7VA/< 2.9W Others: < 20VA/1W		D: < 2.5VA/1.5W L: < 2.5VA/1W E1: <4.7VA/2.9W	
W1: 2.7VA /1.8W				

MID models			
	AV2	AV9	AV5
Type	Self power supply		
Consumption	IS and DP: < 12VA/2W E1: < 4.7VA/2.9 W Others: < 20VA/1W		<4.5VA/2.9W E1: < 4.7VA/2.9 W
W1: 2.7VA /1.8W			

## Measurements

Method	TRMS measurements of distorted waveforms
Sampling	1600 samples/s @50 Hz 1900 samples/s @60 Hz

## Available measurements

Active energy	Unit	System	Phase	Note
Imported (+) Total	kWh+	●	●	
Imported (+) partial	kWh+	●	-	
Exported (-) Total	kWh-	●	-	
Imported (+) by tariff (IS, DP)	kWh+	●	-	T1, T2, T3, T4

Reactive energy	Unit	System	Phase
Imported (+) Total	kvarh+	●	-
Imported (+) partial	kvarh+	●	-
Exported (-) Total	kvarh-	●	-
Imported (+) by tariff	kvarh+	●	-

Electrical variable	Unit	System	Phase
Voltage L-N	V	●	●
Voltage L-L	V	●	●
Current	A	-	●
DMD MAX	A	●	-
Active power	kW	●	●
DMD	kW	●	-
DMD MAX	kW	●	-
Apparent power	kVA	●	●
DMD	kVA	●	-
DMD MAX	kVA	●	-
Reactive power	kvar	●	●
Power factor	PF	●	●
Frequency	Hz	●	-
Run hour meter	h	●	-

## Measurement mode

Depending on the APPLICATION setting, a different selection of variables is available on the display (see manual) and the energy calculation is worked out as follows:

- Standard: both kWh+ and kWh- are available;
- EC: easy connection function, the power is always integrated (both in case of positive and negative power).

In MID analyzers the calculation depends on the model:

- PFA: Easy connection, the total energy totalizer (kWh+) is certified according to MID;
- PFB: only the total positive totalizer (kWh+) is certified according to MID. The negative energy totalizer is available but not certified according to MID.

## Energy metering

For every measuring interval time, the energies of the single phases are summed; according to the sign of the result, the positive (kWh+) or negative totalizer (kWh-) is increased.

Example:

P L1= +2 kW, P L2= +2 kW, P L3= -3 kW

Integration time = 1 hour

+kWh=(+2+2-3)x1h=(+1)x1h=1 kWh

-kWh=0 kWh



## Measurement accuracy

Current	AV2	AV9	AV5	AV6
From 0.5 A to 2 A	$\pm(0.5\% \text{ rdg} + 3\text{dgt})$		-	-
From 2 A to 65 A	$\pm(0.5\% \text{ rdg} + 1\text{dgt})$		-	-
From 0.05 A to 1 A	-	-	$\pm(0.5\% \text{ rdg} + 3\text{dgt})$	
From 1 A to 10 A	-	-	$\pm(0.5\% \text{ rdg} + 1\text{dgt})$	

Phase-phase voltage	AV2	AV9	AV5	AV6
In the range $U_n$	$\pm(1\% \text{ rdg} + 1\text{dgt})$			

Phase-neutral voltage	AV2	AV9	AV5	AV6
In the range $U_n$	$\pm(0.5\% \text{ rdg} + 1\text{dgt})$			

Active and apparent power	AV2	AV9	AV5	AV6
From 1.0 A to 65.0 A (PF=0.5L, 1, 0.8C)	$\pm(1\% \text{ rdg} + 1\text{dgt})$		-	
From 0.5 A to 1.0 A (PF=1)	$\pm(1.5\% \text{ rdg} + 1\text{dgt})$		-	
From 0.25 A to 10 A (PF=0.5L, 1, 0.8C)	-	-	$\pm(1\% \text{ rdg} + 1\text{dgt})$	
From 0.05 A to 0.25 A (PF=1)	-	-	$\pm(1.5\% \text{ rdg} + 1\text{dgt})$	

Reactive power	AV2	AV9	AV5	AV6
From 1.0 A to 2.0 A ( $\sin\phi=0.5L$ , 0.5C)	$\pm(2.5\% \text{ rdg} + 1 \text{ dgt})$		-	
From 0.5 A to 1.0 A ( $\sin\phi=1$ )				
From 2.0 A to 65.0 A ( $\sin\phi=0.5L$ , 0.5C)	$\pm(2\% \text{ rdg} + 1 \text{ dgt})$		-	
From 1.0 A to 65.0 A ( $\sin\phi=1$ )				
From 0.25 A to 0.5 A ( $\sin\phi=0.5L$ , 0.5C)	-	-	$\pm(2.5\% \text{ rdg} + 1 \text{ dgt})$	
From 0.1 A to 0.25 A ( $\sin\phi=1$ )				
From 0.5 A to 10 A ( $\sin\phi=0.5L$ , 0.5C)	-	-	$\pm(2\% \text{ rdg} + 1 \text{ dgt})$	
From 0.25 A to 10 A ( $\sin\phi=1$ )				
Active energy	Class 1 (EN62053-21) Class B (EN50470-3) (MID)			
Reactive energy	Class 2 (EN62053-23)			

Frequency	
From 45 to 65 Hz	$\pm 0.1 \text{ Hz}$

Measurement accuracy according to IEC/EN61557-12 (MID models)	
Active power	Performance class 1
Active energy	Performance class 2

## Display

<b>Type</b>	LCD
<b>Refresh time</b>	< 750 ms
<b>Description</b>	3 rows: 1 <sup>st</sup> : 8 digits (7 mm) 2 <sup>nd</sup> : 4 digits (7 mm) 3 <sup>rd</sup> : 4 digits (7 mm)
<b>Variable readout</b>	Instantaneous: 4 digits, min: 0.000, max: 9999 Energy: 8 digits (imported), 7 digits (exported), min: 0.00, max: 99 999 999

## LED

Model	CT*VT	Weight (kWh per pulse)
AV5/AV6	$\leq 7$	0.001
	$> 7 \leq 70.0$	0.01
	$> 70 \leq 700.0$	0.1
	$> 700$	1
AV2/AV9	N/A	0.001

## Digital outputs/inputs

### Digital outputs: static output (O2)

<b>Connection type</b>	Screw terminals
<b>Maximum number of outputs</b>	2
<b>Type</b>	Open collector
<b>Function</b>	Pulse output or alarm output
<b>Features</b>	V <sub>ON</sub> 1.2 V dc, max. 100 mA V <sub>OFF</sub> 30 V dc max
<b>Configuration parameters</b>	Output function (pulse/alarm) Output normal status Pulse weight (0.001 to 10 kWh/pulse or kvarh/pulse) Pulse duration (30 or 100 ms) Linked variable Alarm delay
<b>Configuration mode</b>	Via joystick

### Digital outputs: relay output (R2)

<b>Connection type</b>	Screw terminals
<b>Maximum number of outputs</b>	2
<b>Type</b>	relay (SPST)
<b>Function</b>	Pulse output or alarm output
<b>Features</b>	AC-1: 5 A@250 V ac DC-12: 5 A@24 V dc AC-15: 1.5 A @ 250 V ac DC-13: 1.5 A @ 24 V dc
<b>Configuration parameters</b>	Output function (pulse/alarm) Output normal status Pulse weight (0.001 to 10 kWh/pulse or kvarh/pulse) Pulse duration (30 or 100 ms) Linked variable Alarm delay
<b>Configuration mode</b>	Via joystick

 Digital inputs (IS, DP)

<b>Number of inputs</b>	3
<b>Functions</b>	Remote status DMD synchronization Pulse counting Tariff management
<b>Frequency</b>	20Hz max, duty cycle 50%
<b>Pulse weight</b>	From 0.001 to 999.9 m3 or kWh per pulse
<b>Contact measuring voltage</b>	5 V dc +/- 5%
<b>Contact measuring current</b>	10 mA max
<b>Input impedance</b>	680Ω
<b>Open contact resistance</b>	≥500 kΩ
<b>Closed contact voltage</b>	≤100 Ω
<b>Configuration parameters</b>	Input function Pulse weight
<b>Configuration mode</b>	Via joystick or UCS software (IS)

## Communication ports

### RS485 port (IS)

<b>Protocol</b>	Modbus RTU
<b>Devices on the same bus</b>	Max 160 (1/5 unit load)
<b>Communication type</b>	Multidrop, bidirectional
<b>Connection type</b>	2 wires
<b>Configuration parameters</b>	Modbus address (from 1 to 247) Baud rate (4.6/9.6 kbps) 1 stop bit, no parity
<b>Refresh time</b>	< 750 ms
<b>Configuration mode</b>	Via joystick or UCS software

### M-Bus (M1, M2)

<b>Protocol</b>	M1: M-Bus according to EN13757-3:2005 M2: M-Bus according to EN13757-3:2013
<b>Driver input capability</b>	1 unit load
<b>Communication type</b>	One-drop, directional
<b>Connection type</b>	2 wires
<b>Configuration parameters</b>	Primary address (1 to 247) Baud rate (0.3/ 2.4 / 9.6 kbps)
<b>Configuration mode</b>	Via joystick

### Ethernet port (E1)

<b>Protocols</b>	Modbus TCP/IP
<b>Client connections</b>	Maximum 5 simultaneously
<b>Connection type</b>	RJ45 connector (10 Base-T, 100 Base-TX), maximum distance 100 m
<b>Configuration parameters</b>	IP address Subnet mask Gateway TCP/IP port DHCP enabling
<b>Configuration mode</b>	Via joystick or UCS software

### Wireless M-Bus (W1)

<b>Protocols</b>	Wireless M-Bus according to EN13757-3, EN13757-4
<b>Frame format</b>	A
<b>Frequency</b>	868 MHz
<b>Mode</b>	T1 or C1
<b>Encryption</b>	No encryption, ENC-Mode 5 or ENC-Mode 7
<b>Transmission interval</b>	Selectable from 10 s to 60 min
<b>Configuration parameters</b>	Frame format Transmission mode Communication interval Encryption enabling
<b>Configuration mode</b>	Via joystick

### Dupline port (DP)

<b>Protocol</b>	Dupline
<b>Connection type</b>	2 wires
<b>Dupline data format</b>	3 1/2 dgt BCD
<b>Full scale value</b>	selectable from 1.999 to 1999 M
<b>Used channels</b>	depending on the number of variables
<b>Multiplexer</b>	A1 to A4 G1 to H8 (1st group of 16 variables) I1 to J8 (2nd group of 16 variables) K1 to L8 (3th group of 16 variables) M1 to N8 (4th group of 16 variables) O1 to P8 (5th group of 16 variables)
<b>Available variables</b>	all, except for the "max" variables
<b>Configuration parameters</b>	Dupline inputs Dupline counters Dupline analogue variables Dupline output
<b>Configuration mode</b>	Via joystick

<b>Counters</b>	
<b>Function</b>	Multiplexer for counter values
<b>Number of counters</b>	6 per instrument, 128 per network
<b>Counter range</b>	0... 99 999 999
<b>Used channels</b>	B to F
<b>Multiplexer</b>	B2 to B8
<b>Reset</b>	B1
<b>Value</b>	C1 to F8
<b>Counter reset</b>	enable/disable function for all the counters
<b>Available counters</b>	kWh tot, -kWh tot, kvarh tot, -kvarh tot, kWh t1, kWh t2, kWh L1, kWh L2, kWh L3, counter dig. in. 1, counter dig. in. 2, counter dig. in. 3, Run hour meter

Input (synchro/tariff)	
Function	Monostable (push-button), realtime
Used channels	A5
Working mode	selectable: <ul style="list-style-type: none"> <li>• none</li> <li>• Wdmd synchronization</li> <li>• total and partial energy meter (kWh, kvarh) managed by time periods (t1-t2).</li> </ul>

Outputs (alarms)	
Function	monostable (push-button)
Used channels	selectable (A1 to P8). No control that the selected channels are not used for counters or analog variables
Number of alarms	2 per instrument
Alarm modes	up alarm, down alarm
Set-point adjustment	from 0 to 100% of the display scale
Hysteresis	from 0 to full scale
On-time delay	0 to 255 s
Output status	normally energised
Available variables	all, except for the "max" variables

Analogue variables	
Function	Multiplexer for analogue values
Number of variables	8 per instrument, 80 per network

# Connection Diagrams

## Three-phase with neutral (4-wire)

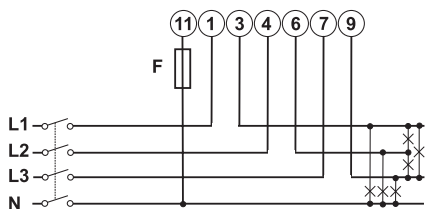


Fig. 4 AV2, AV9

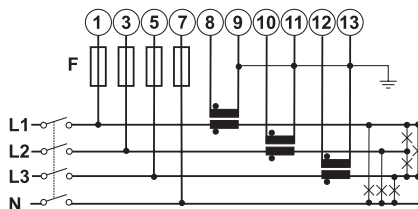


Fig. 5 AV5, AV6

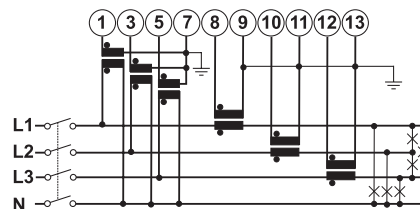


Fig. 6 AV6

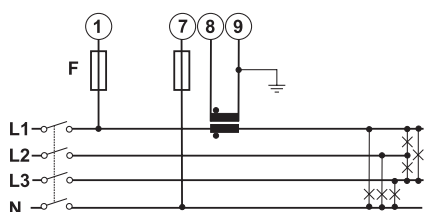


Fig. 7 AV5, AV6 balanced load

## Three-phase without neutral (3-wire)

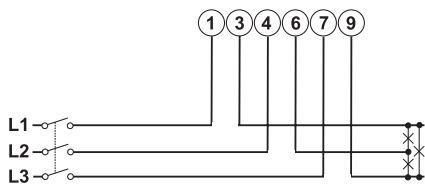


Fig. 8 AV2, AV9 (except IS, R2)

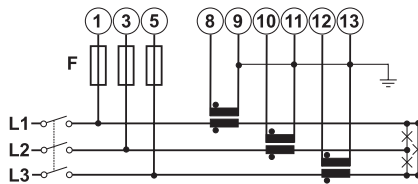


Fig. 9 AV5, AV6

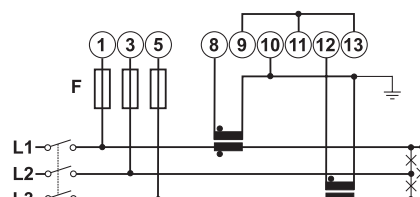


Fig. 10 AV5, AV6

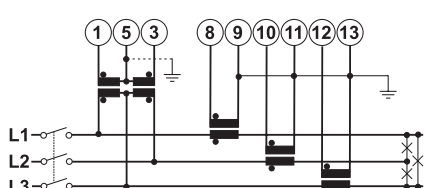


Fig. 11 AV6

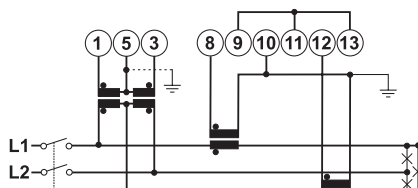


Fig. 12 AV6

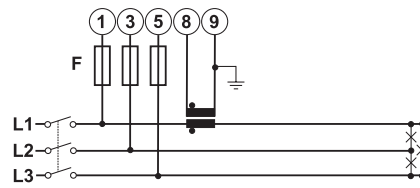


Fig. 13 AV5, AV6 balanced load

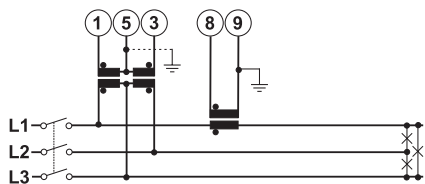


Fig. 14 AV6 balanced load

## Two-phase system with neutral (3-wire)



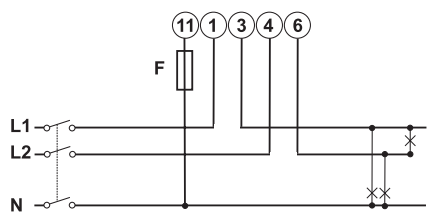


Fig. 15 AV2, AV9

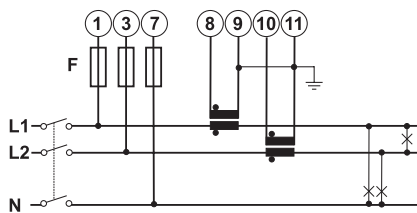


Fig. 16 AV5, AV6

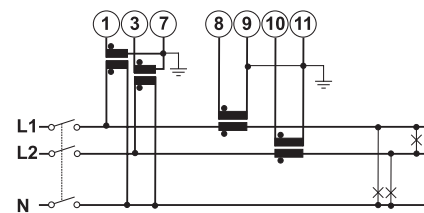


Fig. 17 AV6

Single-phase (2-wire)

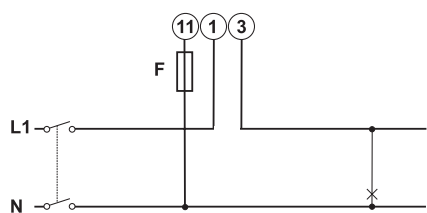


Fig. 18 AV2, AV9 (except IS, R2, M1)

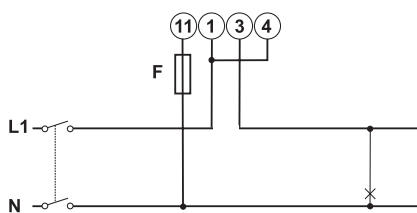


Fig. 19 AV2, AV9 (IS, R2, M1)

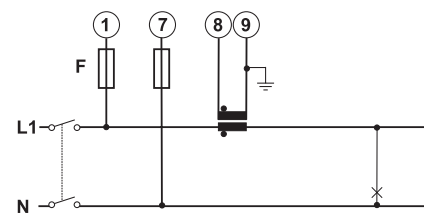


Fig. 20 AV5, AV6

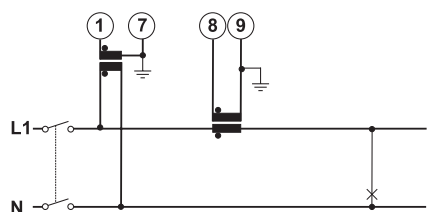


Fig. 21 AV6

Power supply

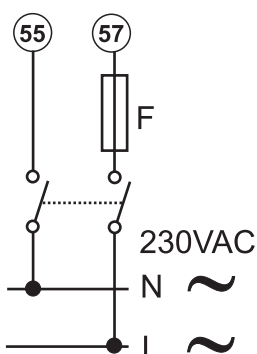


Fig. 22 D option. F = 250 V, 50 mA

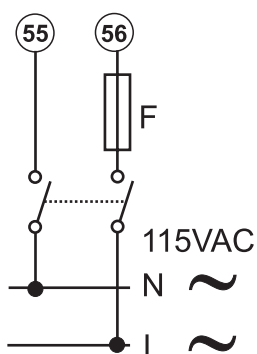


Fig. 23 D option. F = 250 V, 100 mA

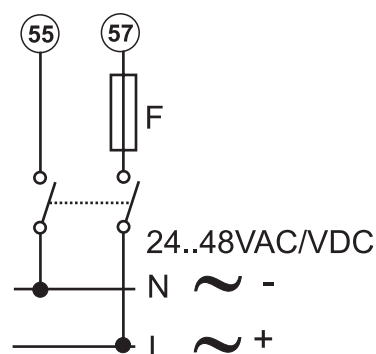
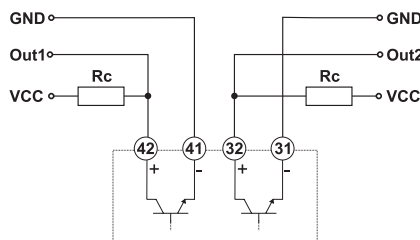
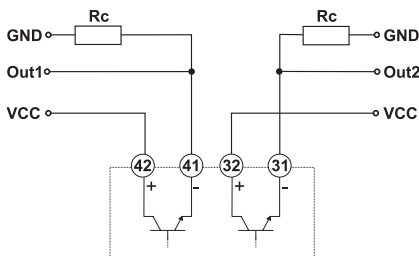


Fig. 24 L option. F = 250 V, 200 mA

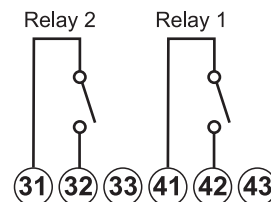
**Static outputs and relay outputs**



**Fig. 25** Static outputs, GND reference

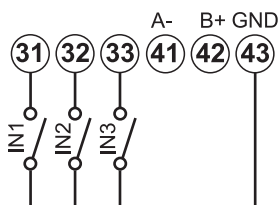


**Fig. 26** Static outputs, VCC reference

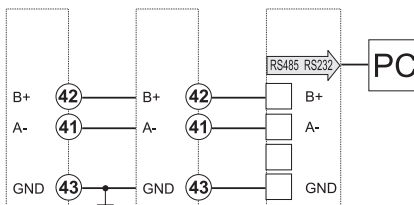


**Fig. 27** Relay outputs

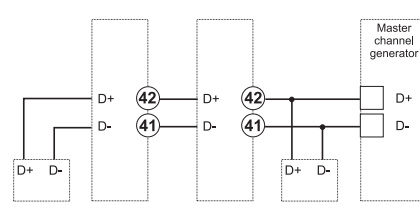
**Digital inputs, RS485 and Dupline ports**



**Fig. 28** Digital inputs

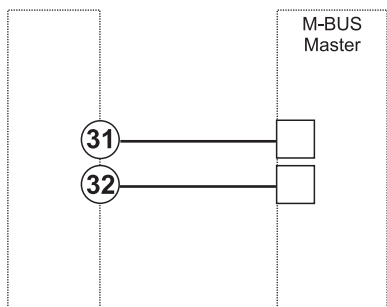


**Fig. 29** RS485 port



**Fig. 30** Dupline port

**M-Bus**



**Fig. 31** M-Bus port

Note: F=315 mA

## MID connection diagrams

### Three-phase with neutral (4-wire)

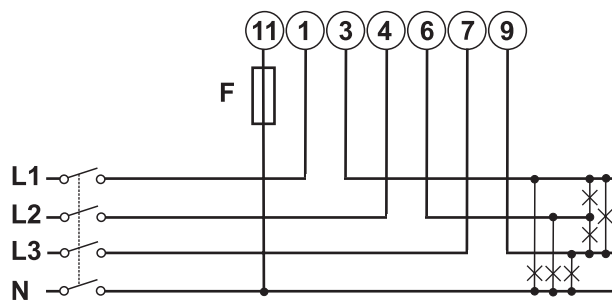


Fig. 32 AV2, AV9

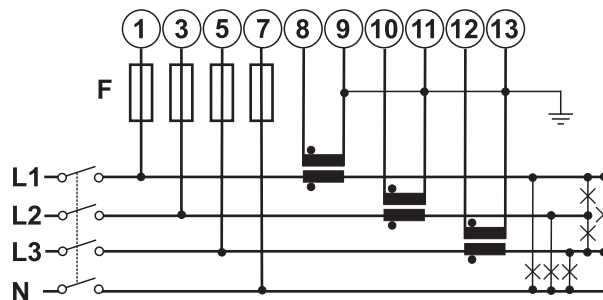


Fig. 33 AV5

### Three-phase without neutral (3-wire) (W1 only)

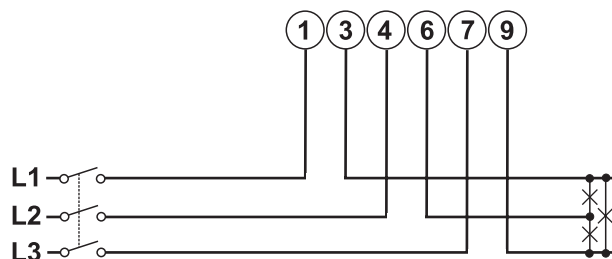


Fig. 34 AV2

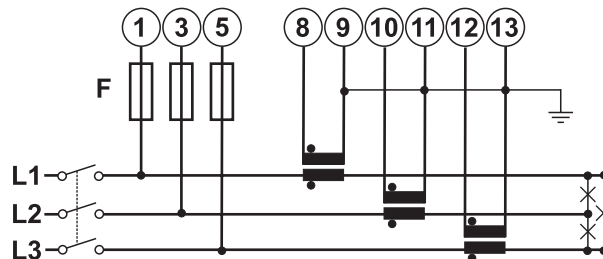


Fig. 35 AV5

### Single-phase (2-wire) (W1 only)

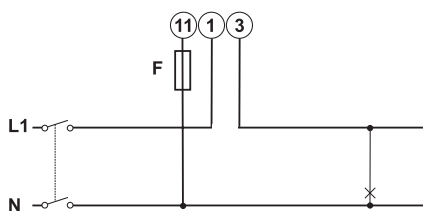


Fig. 36 AV2 1X

Note: F=315 mA

## References

### Order code

#### Non MID models

Component name/part number	I/O communication	Voltage inputs	Current inputs	Power supply
EM24DIN AV5 3D XX X	none	230V L-N 400V L-L	5 (10) A via CT	115/230 V ac
EM24DIN AV9 3X XX X	none	230V L-N 400V L-L	10 (65) A	Self power supply

Component name/part number	I/O communication	Voltage inputs	Current inputs	Power supply
EM24DIN AV5 3D R2 X	2 relay outputs	230V L-N 400V L-L	5 (10) A via CT	115/230 V ac
EM24DIN AV9 3X R2 X	2 relay outputs	230V L-N 400V L-L	10 (65) A	Self power supply

Component name/part number	I/O communication	Voltage inputs	Current inputs	Power supply
EM24DIN AV5 3D O2 X	2 static outputs	230V L-N 400V L-L	5 (10) A via CT	115/230 V ac
EM24DIN AV5 3L O2 X	2 static outputs	230V L-N 400V L-L	10 (65) A	From 24 to 48 V ac/dc
EM24DIN AV6 3D O2 X	2 static outputs	From 57.7 to 120 V L-N From 100 to 208 V L-L	5 (10) A via CT	115/230 V ac
EM24DIN AV6 3L O2 X	2 static outputs	From 57.7 to 120 V L-N From 100 to 208 V L-L	5 (10) A via CT	From 24 to 48 V ac/dc
EM24DIN AV2 3X O2 X	2 static outputs	From 133 to 230 V L-N From 230 to 400 V L-L	10 (65) A	Self power supply
EM24DIN AV9 3X O2 X	2 static outputs	230V L-N 400V L-L	10 (65) A	Self power supply



Component name/part number	I/O communication	Voltage inputs	Current inputs	Power supply
EM24DIN AV5 3D DP X	3 digital inputs + Dupline	230V L-N 400V L-L	5 (10) A via CT	115/230 V ac
EM24DIN AV5 3L DP X	3 digital inputs + Dupline	230V L-N 400V L-L	5 (10) A via CT	From 24 to 48 V ac/dc
EM24DIN AV6 3D DP X	3 digital inputs + Dupline	From 57.7 to 120 V L-N From 100 to 208 V L-L	5 (10) A via CT	115/230 V ac
EM24DIN AV6 3L DP X	3 digital inputs + Dupline	From 57.7 to 120 V L-N From 100 to 208 V L-L	5 (10) A via CT	From 24 to 48 V ac/dc
EM24DIN AV2 3X DP X	3 digital inputs + Dupline	From 133 to 230 V L-N From 230 to 400 V L-L	10 (65) A	Self power supply
EM24DIN AV9 3X DP X	3 digital inputs + Dupline	230V L-N 400V L-L	10 (65) A	Self power supply

Component name/part number	I/O communication	Voltage inputs	Current inputs	Power supply
EM24DIN AV5 3D IS X	3 digital inputs + RS485 Modbus RTU	230V L-N 400V L-L	5 (10) A via CT	115/230 V ac
EM24DIN AV5 3L IS X	3 digital inputs + RS485 Modbus RTU	230V L-N 400V L-L	5 (10) A via CT	From 24 to 48 V ac/dc
EM24DIN AV6 3D IS X	3 digital inputs + RS485 Modbus RTU	From 57.7 to 120 V L-N From 100 to 208 V L-L	5 (10) A via CT	115/230 V ac
EM24DIN AV6 3L IS X	3 digital inputs + RS485 Modbus RTU	From 57.7 to 120 V L-N From 100 to 208 V L-L	5 (10) A via CT	From 24 to 48 V ac/dc
EM24DIN AV2 3X IS X	3 digital inputs + RS485 Modbus RTU	From 133 to 230 V L-N From 230 to 400 V L-L	10 (65) A	Self power supply
EM24DIN AV9 3X IS X	3 digital inputs + RS485 Modbus RTU	230V L-N 400V L-L	10 (65) A	Self power supply

Component name/part number	I/O communication	Voltage inputs	Current inputs	Power supply
EM24DIN AV5 3X E1 X	Ethernet Modbus TCP/IP	From 120 to 277 V L-N From 208 to 480 V L-L	5 (10) A via CT	Self power supply
EM24DIN AV2 3X E1 X	Ethernet Modbus TCP/IP	From 120 to 277 V L-N From 208 to 480 V L-L	10 (65) A	Self power supply



Component name/part number	I/O communication	Voltage inputs	Current inputs	Power supply
EM24DIN AV5 3D M1 X	M-Bus according to EN 13757-3 (2005)	230V L-N 400V L-L	5 (10) A via CT	115/230 V ac
EM24DIN AV5 3L M1 X	M-Bus according to EN 13757-3 (2005)	230V L-N 400V L-L	5 (10) A via CT	From 24 to 48 V ac/dc
EM24DIN AV6 3D M1 X	M-Bus according to EN 13757-3 (2005)	From 57.7 to 120 V L-N From 100 to 208 V L-L	5 (10) A via CT	115/230 V ac
EM24DIN AV6 3L M1 X	M-Bus according to EN 13757-3 (2005)	From 57.7 to 120 V L-N From 100 to 208 V L-L	5 (10) A via CT	From 24 to 48 V ac/dc
EM24DIN AV2 3X M1 X	M-Bus according to EN 13757-3 (2005)	From 133 to 230 V L-N From 230 to 400 V L-L	10 (65) A	Self power supply
EM24DIN AV9 3X M1 X	M-Bus according to EN 13757-3 (2005)	230V L-N 400V L-L	10 (65) A	Self power supply

Component name/part number	I/O communication	Voltage inputs	Current inputs	Power supply
EM24DIN AV5 3D M2 X	M-Bus according to EN 13757-3 (2013)	230V L-N 400V L-L	5 (10) A via CT	115/230 V ac
EM24DIN AV5 3L M2 X	M-Bus according to EN 13757-3 (2013)	230V L-N 400V L-L	5 (10) A via CT	From 24 to 48 V ac/dc
EM24DIN AV6 3D M2 X	M-Bus according to EN 13757-3 (2013)	From 57.7 to 120 V L-N From 100 to 208 V L-L	5 (10) A via CT	115/230 V ac
EM24DIN AV6 3L M2 X	M-Bus according to EN 13757-3 (2013)	From 57.7 to 120 V L-N From 100 to 208 V L-L	5 (10) A via CT	From 24 to 48 V ac/dc
EM24DIN AV2 3X M2 X	M-Bus according to EN 13757-3 (2013)	From 133 to 230 V L-N From 230 to 400 V L-L	10 (65) A	Self power supply
EM24DIN AV9 3X M2 X	M-Bus according to EN 13757-3 (2013)	230V L-N 400V L-L	10 (65) A	Self power supply

Component name/part number	I/O communication	Voltage inputs	Current inputs	Power supply
EM24DIN AV5 3X W1 I X	Wireless M-Bus, internal antenna	From 120 to 277 V L-N From 208 to 480 V L-L	5 (10) A via CT	Self power supply
EM24DIN AV5 3X W1 E X	Wireless M-Bus, external antenna	From 120 to 277 V L-N From 208 to 480 V L-L	5 (10) A via CT	Self power supply
EM24DIN AV2 3X W1 I X	Wireless M-Bus, internal antenna	From 120 to 277 V L-N From 208 to 480 V L-L	10 (65) A	Self power supply
EM24DIN AV2 3X W1 E X	Wireless M-Bus, external antenna	From 120 to 277 V L-N From 208 to 480 V L-L	10 (65) A	Self power supply
EM24DIN AV2 1X W1 I X	Wireless M-Bus, internal antenna, 1-phase	From 120 to 277 V L-N	10 (65) A	Self power supply
EM24DIN AV2 1X W1 E X	Wireless M-Bus, external antenna, 1-phase	From 120 to 277 V L-N	10 (65) A	Self power supply

#### MID models

Component name/part number	I/O communication	Voltage inputs	Current inputs	Power supply
EM24DIN AV5 3X XX PFA EM24DIN AV5 3X XX PFB	none	230V L-N 400V L-L	5 (10) A via CT	Self power supply
EM24DIN AV2 3X XX PFA EM24DIN AV2 3X XX PFB	none	230V L-N 400V L-L	10 (65) A	Self power supply
EM24DIN AV9 3X XX PFA EM24DIN AV9 3X XX PFB	none	230V L-N 400V L-L	10 (65) A	Self power supply

Component name/part number	I/O communication	Voltage inputs	Current inputs	Power supply
EM24DIN AV5 3X O2 PFA EM24DIN AV5 3X O2 PFB	2 static outputs	230V L-N 400V L-L	5 (10) A via CT	Self power supply
EM24DIN AV2 3X O2 PFA EM24DIN AV2 3X O2 PFB	2 static outputs	230V L-N 400V L-L	10 (65) A	Self power supply
EM24DIN AV9 3X O2 PFA EM24DIN AV9 3X O2 PFB	2 static outputs	230V L-N 400V L-L	10 (65) A	Self power supply

Component name/part number	I/O communication	Voltage inputs	Current inputs	Power supply
EM24DIN AV5 3X DP PFA EM24DIN AV5 3X DP PFB	3 digital inputs + Dupline	230V L-N 400V L-L	5 (10) A via CT	Self power supply
EM24DIN AV2 3X DP PFA EM24DIN AV2 3X DP PFB	3 digital inputs + Dupline	230V L-N 400V L-L	10 (65) A	Self power supply

Component name/part number	I/O communication	Voltage inputs	Current inputs	Power supply
EM24DIN AV5 3X IS PFA EM24DIN AV5 3X IS PFB	3 digital inputs + RS485 Modbus RTU	230V L-N 400V L-L	5 (10) A via CT	Self power supply
EM24DIN AV2 3X IS PFA EM24DIN AV2 3X IS PFB	3 digital inputs + RS485 Modbus RTU	230V L-N 400V L-L	10 (65) A	Self power supply
EM24DIN AV9 3X IS PFA EM24DIN AV9 3X IS PFB	3 digital inputs + RS485 Modbus RTU	230V L-N 400V L-L	10 (65) A	Self power supply

Component name/part number	I/O communication	Voltage inputs	Current inputs	Power supply
EM24DIN AV5 3X E1 PFA EM24DIN AV5 3X E1 PFB	Ethernet Modbus TCP/IP	230V L-N 400V L-L	5 (10) A via CT	Self power supply
EM24DIN AV2 3X E1 PFA EM24DIN AV2 3X E1 PFB	Ethernet Modbus TCP/IP	230V L-N 400V L-L	10(65) A	Self power supply

Component name/part number	I/O communication	Voltage inputs	Current inputs	Power supply
EM24DIN AV5 3X M1 PFA EM24DIN AV5 3X M1 PFB	M-Bus according to EN 13757-3 (2005)	230V L-N 400V L-L	5 (10) A via CT	Self power supply
EM24DIN AV2 3X M1 PFA EM24DIN AV2 3X M1 PFB	M-Bus according to EN 13757-3 (2005)	230V L-N 400V L-L	10(65) A	Self power supply

Component name/part number	I/O communication	Voltage inputs	Current inputs	Power supply
EM24DIN AV5 3X W1 I PFA EM24DIN AV5 3X W1 I PFB	Wireless M-Bus, internal antenna	230V L-N 400V L-L	5 (10) A via CT	Self power supply
EM24DIN AV5 3X W1 E PFA EM24DIN AV5 3X W1 E PFB	Wireless M-Bus, external antenna	230V L-N 400V L-L	5 (10) A via CT	Self power supply
EM24DIN AV2 3X W1 I PFA EM24DIN AV2 3X W1 I PFB	Wireless M-Bus, internal antenna	230V L-N 400V L-L	10(65) A	Self power supply
EM24DIN AV2 3X W1 E PFA EM24DIN AV2 3X W1 E PFB	Wireless M-Bus, external antenna	230V L-N 400V L-L	10(65) A	Self power supply
EM24DIN AV2 1X W1 I PFA EM24DIN AV2 1X W1 I PFB	Wireless M-Bus, internal antenna, 1-phase	230V L-N	10(65) A	Self power supply
EM24DIN AV2 1X W1 E PFA EM24DIN AV2 1X W1 E PFB	Wireless M-Bus, external antenna, 1-phase	230V L-N	10(65) A	Self power supply

- PFA: Easy connection, the total energy totalizer (kWh+) is certified according to MID;
- PFB: only the total positive totalizer (kWh+) is certified according to MID. The negative energy totalizer is available but not certified according to MID.

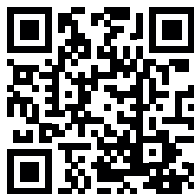


## Further reading

Information	Where to find it
User manual - E1	<a href="http://www.productselection.net/MANUALS/UK/em24_E1_im_use.pdf">www.productselection.net/MANUALS/UK/em24_E1_im_use.pdf</a>
Installation instruction - E1	<a href="http://www.productselection.net/MANUALS/UK/em24_E1_im_inst.pdf">www.productselection.net/MANUALS/UK/em24_E1_im_inst.pdf</a>
User manual - IS	<a href="http://www.productselection.net/MANUALS/UK/em24_IS_im_use.pdf">www.productselection.net/MANUALS/UK/em24_IS_im_use.pdf</a>
Installation instruction - IS	<a href="http://www.productselection.net/MANUALS/UK/em24_IS_im_inst.pdf">www.productselection.net/MANUALS/UK/em24_IS_im_inst.pdf</a>
User manual - M1/M2	<a href="http://www.productselection.net/MANUALS/UK/em24_M1/M2_im_use.pdf">www.productselection.net/MANUALS/UK/em24_M1/M2_im_use.pdf</a>
Installation instruction - M1/M2	<a href="http://www.productselection.net/MANUALS/UK/em24_M1/M2_im_inst.pdf">www.productselection.net/MANUALS/UK/em24_M1/M2_im_inst.pdf</a>
User manual - W1	<a href="http://www.productselection.net/MANUALS/UK/em24_W1_im_use.pdf">www.productselection.net/MANUALS/UK/em24_W1_im_use.pdf</a>
Installation instruction - W1	<a href="http://www.productselection.net/MANUALS/UK/em24_W1_im_inst.pdf">www.productselection.net/MANUALS/UK/em24_W1_im_inst.pdf</a>
Instruction manual - other versions	<a href="http://www.productselection.net/MANUALS/UK/em24_im.pdf">www.productselection.net/MANUALS/UK/em24_im.pdf</a>
Instruction manual - other versions MID	<a href="http://www.productselection.net/MANUALS/UK/em24_mid_im.pdf">www.productselection.net/MANUALS/UK/em24_mid_im.pdf</a>

## CARLO GAVAZZI compatible components

Purpose	Component name/part number	NOTES
Monitor data from several analyzers	VMU-C	See relevant datasheet
Collect data from wireless M-Bus devices and transmit data via Modbus TCP/IP	SIU-MBM-02	See relevant datasheet



COPYRIGHT ©2020  
Content subject to change. Download the PDF: [www.productselection.net](http://www.productselection.net)

## X-ON Electronics

Largest Supplier of Electrical and Electronic Components

*Click to view similar products for [Power Analysers](#) category:*

*Click to view products by [Carlo Gavazzi](#) manufacturer:*

Other Similar products are found below :

[AQ1018](#) [AQ1038](#) [AR1039](#) [AD1016H](#) [AD1040](#) [MOA2](#) [MOO2](#) [MOR2](#) [EM2172DAV63XOSX](#) [AQ1042](#) [AD1047](#) [58250-1854](#)  
[WM20AV53H](#) [AD2000](#) [AQ2030](#) [AR1060](#) [EM24DINAV93XISX](#) [EM2696AV53HR2S1XX](#) [EM50DINMA53HRSMC](#) [MC485232](#) [MCETH](#)  
[MFI6R4](#) [WM1496AV53CX](#) [WM1496AV63CX](#) [WM1496AV63DS](#) [WM30AV53H](#) [WM30AV63H](#) [WM30AV63L](#) [WM40AV53H](#)  
[WM50AV53HBC](#) [CS-BB3-04](#) [58250-1852](#) [58250-1853](#) [TOL-18585](#) [WM1596AV53XOSPFB](#) [WM1596AV53XOSX](#)  
[WM1596AV53XOXPFB](#) [WM1596AV53XOXX](#) [EM24DINAV53DISX](#) [EM28072DMV53X2SX](#) [EM28072DMV63X2SX](#)  
[EM50DINAV53HR SX](#) [EM50DINRG53HR SX](#) [EM50DINMV53HR SX](#) [WM1496AV53HDG](#) [WM14-96AV63CS](#) [58430-1286](#)