

Photoelectrics

Retro-reflective for Transparent Objects

Type PD30CNG02....RT



- Miniature sensor range
- Range: 2 m, with reflector
- Sensitivity adjustment by Teach-In programming
- Modulated, red light 617 nm
- Supply voltage: 10 to 30 VDC
- Output: 100 mA, NPN or PNP preset
- Make and break switching function programmable
- LED indication for output, stability and power ON
- Protection: reverse polarity, short circuit and transients
- Cable and plug versions
- Excellent EMC performance
- Remote teach features



Product Description

The PD30CNG02 sensor family comes in a compact 10 x 30 x 20 mm reinforced PMMA/ABS housing. The sensors are useful in applications where detection of transparent objects are needed. Compact housing and high power LED for excellent performance-size ratio.

The Teach-In function for adjustment of the sensitivity makes the sensors highly flexible. The output type is preset (NPN or PNP), and the output switching function is programmable (NO or NC). A remote teach feature allow the sensor to be set up from e.g. a PLC.

Ordering Key

PD30CNG02PPM5RT

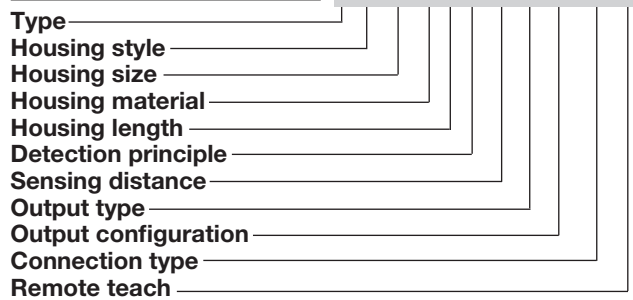

Type Selection

| Housing W x H x D | Range S _n | Connection | Ordering no. NPN Make or break switching | Ordering no. PNP Make or break switching |
|----------------------|-------------------------|------------|--|--|
| 10 x 30 x 20 mm | 2 m | Cable | PD 30 CNG 02 NPRT | PD 30 CNG 02 PPRT |
| 10 x 30 x 20 mm | 2 m | Plug | PD 30 CNG 02 NPM5RT | PD 30 CNG 02 PPM5RT |

Note: Reflectors to be ordered separately

Specifications EN 60947-5-2

| | | | |
|--|---|---------------------------------------|--|
| Rated operating distance (S_n) | Up to 2 m, with reflector Ø 80 mm (ER4) | Light source | inGaAlP, LED, 617 nm |
| Detection reliability | 20% attenuation | Light type, not polarized | Red, modulated |
| Blind zone | 10 mm | Sensing angle | ± 2° |
| Sensitivity | Adjustable by Teach-In | Ambient light | 10,000 lux |
| Temperature drift | ≤ 0.1%/°C Teach settings are valid for teach temperature ± 20°C | Light spot | 110 mm @ 1.5 m |
| Hysteresis (H) (differential travel) | ≤ 10% | Operating frequency | 1000 Hz |
| Rated operational volt. (U_B) | 10 to 30 VDC (ripple included) | Response time | |
| Ripple (U_{ripple}) | ≤ 10% | OFF-ON (t _{ON}) | ≤ 0.5 ms |
| Output current | | ON-OFF (t _{OFF}) | ≤ 0.5 ms |
| Continuous (I _a) | ≤ 100 mA | Power ON delay (t_v) | ≤ 300 ms |
| Short-time (I) | ≤ 100 mA (max. load capacity 100 nF) | Output function | |
| No load supply current (I_o) | ≤ 30 mA @ 24 VDC | NPN and PNP | Preset |
| Minimum operational current (I_m) | 0.5 mA | NO/NC switching function | Set up by button |
| OFF-state current (I_r) | ≤ 100 µA | Remote teach function | |
| Voltage drop (U_d) | ≤ 2.4 VDC @ 100 mA | Teach on (push button active) | 0 to 2.5 VDC (NPN) 5 to 30 VDC (PNP) |
| Protection | Short-circuit, reverse polarity and transients | Tamper proof | When activated more than 20 sec. the sensor goes into a Tamper proof mode. |
| | | Indication | |
| | | Output ON | LED, yellow |
| | | Signal stability ON and power ON | LED, green |



Specifications (cont.) EN 60947-5-2

| | | | |
|----------------------------|--|---------------------------------|--|
| Environment | | Rated insulation voltage | 500 VAC (rms) |
| Installation category | III (IEC 60664/60664A; 60947-1) | Housing material | |
| Pollution degree | 3 (IEC 60664/60664A; 60947-1) | Body | ABS |
| Degree of protection | IP 67 (IEC 60529; 60947-1) | Front material | PMMA, red |
| Ambient temperature | | Connection | |
| Operating | -25° to +55°C (-13° to +131°F) | Cable | PVC, black, 2 m 4 x 0.14 mm ² , Ø = 3.3 mm |
| Storage | -40° to +70°C (-40° to +158°F) | Plug | M8, 4-pin (CON, 54-series) |
| Vibration | 1 | Weight | With cable: 40 g With plug: 10 g |
| | 0 to 55 Hz, 0.5 mm/7.5 g (IEC 60068-2-6) | CE-marking | Yes |
| Shock | | Approvals | cULus (UL508) |
| | 30 g / 11ms, 3 pos, 3 neg per axis (IEC 60068-2-6, 60068-2-32) | | |

Operation Diagram

tv = Power ON delay

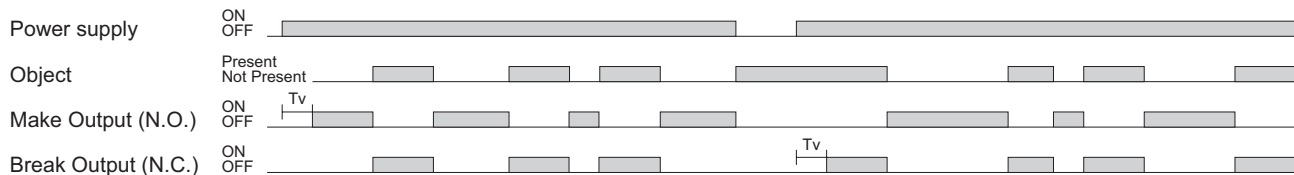

Wiring Diagrams

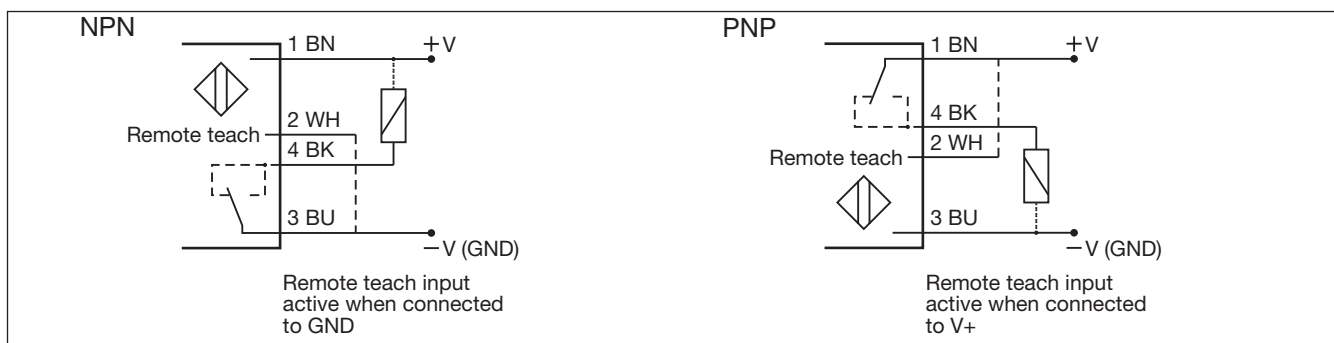

Detection Diagram

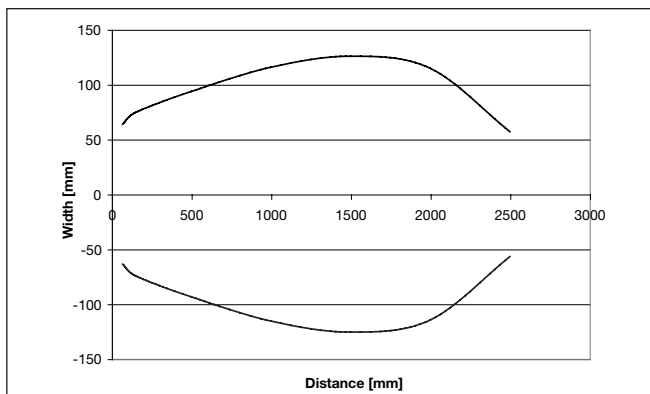

Excess Gain

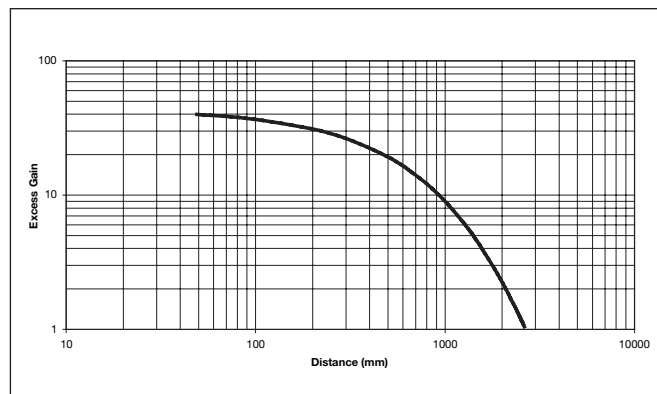

Signal Stability Indication

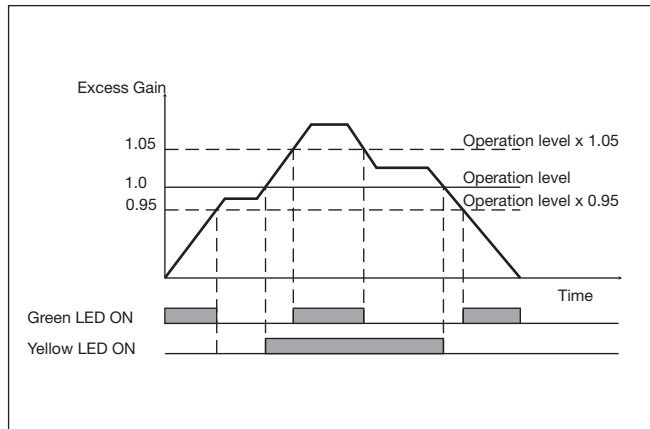

Accessories

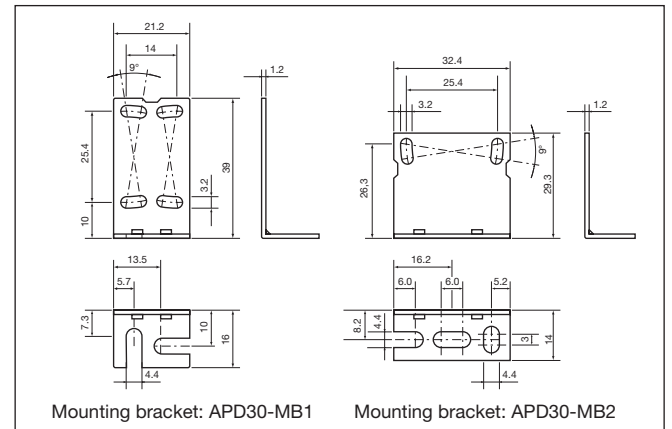

Dimensions

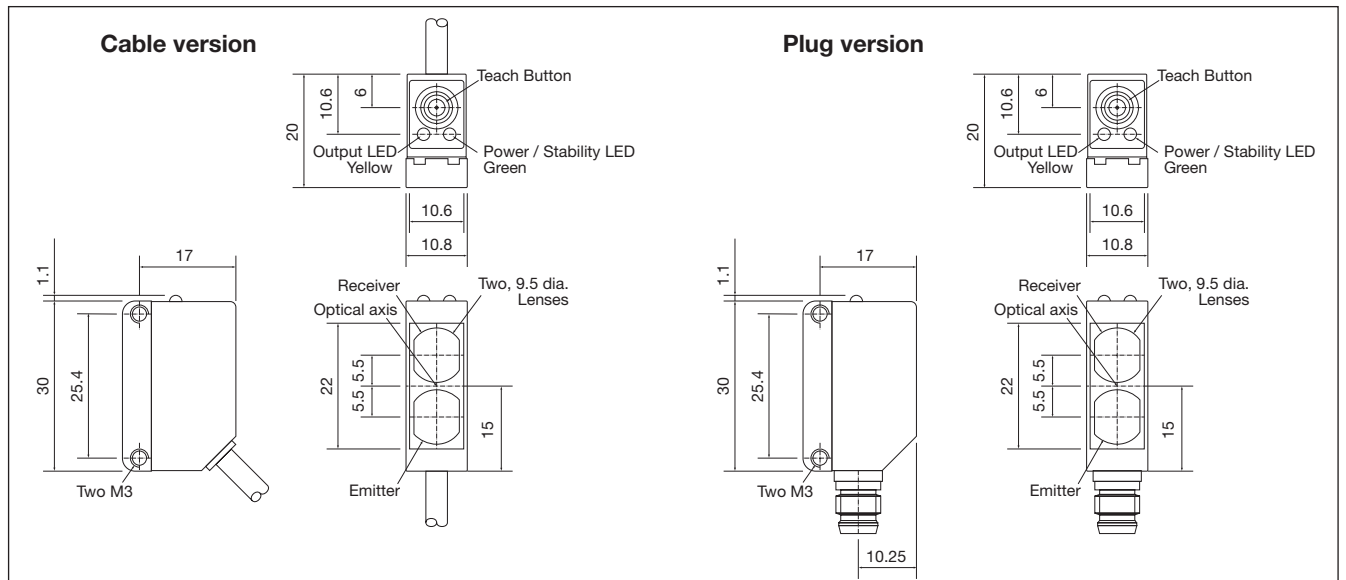

Installation Hints

| | | | |
|---|---|--|--|
| <p>To avoid interference from inductive voltage / current peaks, separate the proximity switch cables from any other power cables. E.g. Engine, contactor or solenoid cables</p> <p>Incorrect Correct</p> <p>> 100 mm</p> | <p>Relief of the cable strain</p> <p>Incorrect Correct</p> <p>The cable should not be pulled</p> | <p>Protection of the sensing face</p> <p>Incorrect</p> <p>A proximity switch should not serve as mechanical stop</p> | <p>Sensor mounted on a mobile carrier</p> <p>Any repetitive flexing of the cable should be avoided</p> |
|---|---|--|--|

Delivery Contents

- Photoelectric switch: PD 30 CNG 02...RT
- Installation instruction
- Mounting bracket APD30-MB1
- **Packaging:** Cardboard box

Accessories

- Reflector is to be purchased separately
- Mounting bracket APD30-MB2 to be purchased separately

Teach functions

Normal operation, optimized switching point.

1. Line up the sensor with the reflector. Yellow LED and Green LED are ON.
2. Press the button for 3 seconds until both LEDs flashes simultaneously.
(The first switch point is stored)
3. Place the object between the sensor and reflector in the detection zone.
4. Press the button once and the sensor is ready to operate (Green LED ON, Yellow LED ON)
(The second switch point is stored)

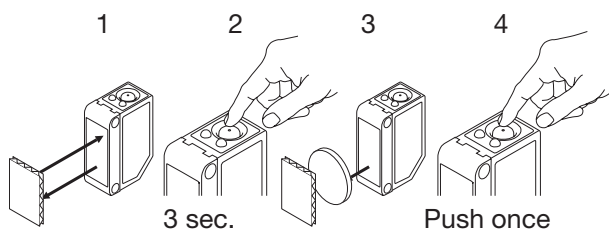

For make or break set-up (N.O. or N.C.)

1. Press the button for 10 seconds, until the green LEDs flashes.
2. While the green LED flashes, the output is inverted each time the button is pressed. Yellow LED indicates N.O. function selected.
If the button is not pressed within the next 10 seconds, the current output is stored.

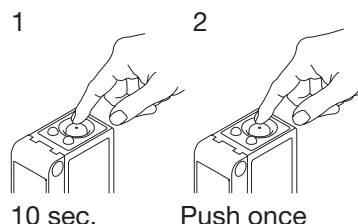

For maximum sensing distance (default setting)

1. Line up the sensor with the reflector, place a new transparent object between the sensor and reflector in the detection zone. Yellow LED is OFF and Green LED is ON.
2. Press the button for 3 seconds until both LEDs flashes simultaneously.
(The first switch point is stored)
3. Press the button a second time and the sensor is ready to operate (Green LED ON, Yellow LED ON)
(The second switch point is stored)

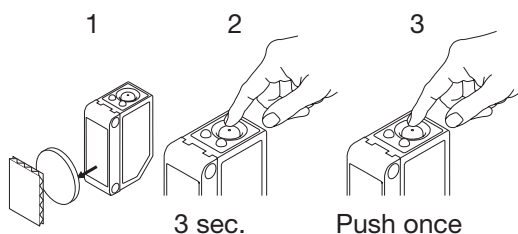

For the most transparent objects

1. Line up the sensor with the reflector. Yellow LED and Green LED are ON.
2. Press the button for 3 seconds until both LEDs flashes simultaneously.
(The first switch point is stored)
3. Press the button a second time and the sensor is ready to operate (Green LED ON, Yellow LED ON)
(The second switch point is stored)

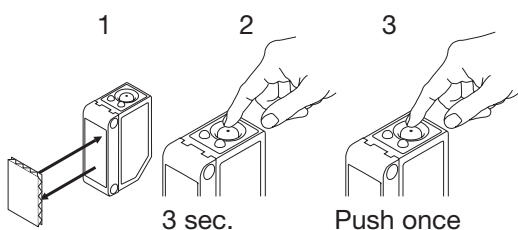

X-ON Electronics

Largest Supplier of Electrical and Electronic Components

Click to view similar products for [Photoelectric Sensors](#) category:

Click to view products by [Carlo Gavazzi](#) manufacturer:

Other Similar products are found below :

[7442AD2X5FRX](#) [EX-19B-LP](#) [7443AR0X5FRX](#) [7452AD4D4NNX](#) [F3WD052C5M](#) [7655AR-04-F-1-2-RX](#) [7694ADE04DS2X](#) [FE7C-FRC6S-M](#) [PM-R24-R](#) [Q45VR2FPQ](#) [13104RQD07](#) [E3JUXM4MN](#) [E3L2DC4](#) [E3S3LE21](#) [E3SCT11M1J03M](#) [E3SDS20E21](#) [E3VDS70C43S](#)
[E3XNM16](#) [BR23P](#) [HOA6563-001](#) [OJ-3307-30N8](#) [OS-311A-30](#) [P32013](#) [P34036](#) [P43004](#) [P56001](#) [P60001](#) [PB10CNT15PO](#) [S14132](#) [935286-000](#) [S52101](#) [S56258](#) [SH-21E](#) [FD-SN500](#) [FE7B-FDRB6-M](#) [SU-79](#) [T36342](#) [T40300](#) [T60001](#) [PD60CNX20BP](#) [FX2-A3R](#) [FX-302-HY](#) [FZS](#)
[PM-T64W](#) [PX-22](#) [PZ2-51P](#) [CX-491-P-J](#) [CYNUTX10](#) [UZH802](#) [UZH803](#)