

# Photoelectrics Retro-reflective, Polarized Type PD30CNP06....DU

CARLO GAVAZZI



- Miniature sensor range
- Range: 6 m, with reflector
- Sensitivity adjustment by Teach-In programming
- Modulated, red light 660 nm, polarized
- Supply voltage: 10 to 30 VDC
- Output: 100 mA, NPN or PNP preset
- Make and break switching function programmable
- LED indication for output, stability and power ON
- Protection: reverse polarity, short circuit and transients
- Cable and plug versions
- Excellent EMC performance
- Dust alarm output



## Product Description

The PD30CNP06 sensor family comes in a compact 10 x 30 x 20 mm reinforced PMMA/ABS housing. The sensors are useful in applications where high-accuracy detection as well as small size is required. Compact housing and high power LED for excellent performance-size ratio.

The Teach-In function for adjustment of the sensitivity makes the sensors highly flexible. The output type is preset (NPN or PNP), and the output switching function is one programmable (NO or NC) and one dust output NO or NC.

## Ordering Key

PD30CNP06PPM5DU

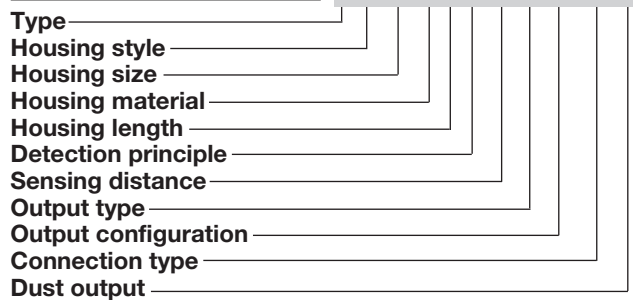

## Type Selection

Housing W x H x D	Range S <sub>n</sub>	Connection	Ordering no. NPN Make or break switching	Ordering no. PNP Make or break switching
10 x 30 x 20 mm	6 m	Cable	PD 30 CNP 06 NPDU	PD 30 CNP 06 PPDU
10 x 30 x 20 mm	6 m	Plug	PD 30 CNP 06 NPM5DU	PD 30 CNP 06 PPM5DU

**Note:** Reflectors to be ordered separately

## Specifications EN 60947-5-2

<b>Rated operating distance (S<sub>n</sub>)</b>	Up to 6 m, with reflector Ø 80 mm (ER4) 4 m on ER4060 reflector	<b>Protection</b>	Short-circuit, reverse polarity and transients
<b>Blind zone</b>	100 mm	<b>Light source</b>	GaAlAs, LED, 660 nm
<b>Sensitivity</b>	Adjustable by Teach-In	<b>Light type</b>	Red, modulated
<b>Temperature drift</b>	≤ 0.1%/°C	<b>Sensing angle</b>	± 2°
<b>Hysteresis (H) (differential travel)</b>	≤ 10%	<b>Ambient light</b>	10,000 lux
<b>Rated operational volt. (U<sub>B</sub>)</b>	10 to 30 VDC (ripple included)	<b>Light spot</b>	110 mm @ 1.5 m
<b>Ripple (U<sub>rpp</sub>)</b>	≤ 10%	<b>Operating frequency</b>	1000 Hz
<b>Output current</b> Continuous (I <sub>a</sub> ) Short-time (I)	≤ 100 mA ≤ 100 mA (max. load capacity 100 nF)	<b>Response time</b> OFF-ON (t <sub>ON</sub> ) ON-OFF (t <sub>OFF</sub> )	≤ 0.5 ms ≤ 0.5 ms
<b>Dust output current</b> Continuous (I <sub>a</sub> ) Short-time (I)	≤ 20 mA ≤ 20 mA (max. load capacity 100 nF)	<b>Power ON delay (t<sub>v</sub>)</b>	≤ 300 ms
<b>No load supply current (I<sub>o</sub>)</b>	≤ 30 mA @ 24 VDC	<b>Output function</b> NPN and PNP NO/NC switching function	Preset Set by button
<b>Minimum operational current (I<sub>m</sub>)</b>	0.5 mA	<b>Output configuration</b> Programming options Output pin 4 black Output	NO or NC NO or NC (dust)
<b>OFF-state current (I<sub>r</sub>)</b>	≤ 100 µA	Dust alarm output Delay on operate	20 ms
<b>Voltage drop (U<sub>d</sub>)</b>	≤ 2.4 VDC @ 100 mA	<b>Indication</b> Output ON Signal stability ON and power ON	LED, yellow LED, green

Specifications are subject to change without notice (12.07.2016)



## Specifications (cont.) EN 60947-5-2

<b>Environment</b>		<b>Rated insulation voltage</b>	500 VAC (rms)
Installation category	III (IEC 60664/60664A; 60947-1)	<b>Housing material</b>	
Pollution degree	3 (IEC 60664/60664A; 60947-1)	Body	ABS
Degree of protection	IP 67 (IEC 60529; 60947-1)	Front material	PMMA, red
<b>Ambient temperature</b>		<b>Connection</b>	
Operating	-25° to +55°C (-13° to +131°F)	Cable	PVC, black, 2 m 4 x 0.14 mm <sup>2</sup> , Ø = 3.3 mm
Storage	-40° to +70°C (-40° to +158°F)	Plug	M8, 4-pin (CON, 54-series)
<b>Vibration</b>	10 to 55 Hz, 0.5 mm/7.5 g (IEC 60068-2-6)	<b>Weight</b>	With cable: 40 g With plug: 10 g
<b>Shock</b>	30 g / 11ms, 3 pos, 3 neg per axis (IEC 60068-2-6, 60068-2-32)	<b>CE-marking</b>	Yes
		<b>Approvals</b>	cULus (UL508)

## Operation Diagram

tv = Power ON delay

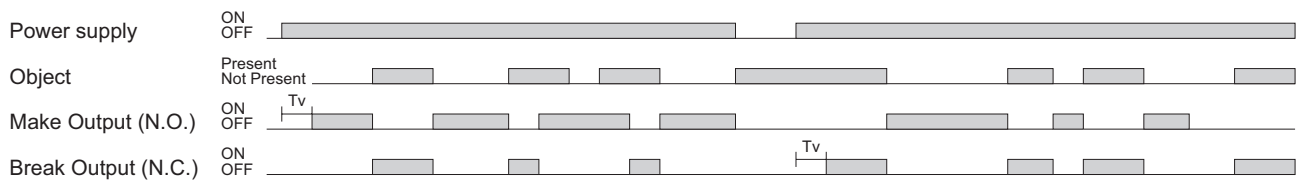

## Wiring Diagrams

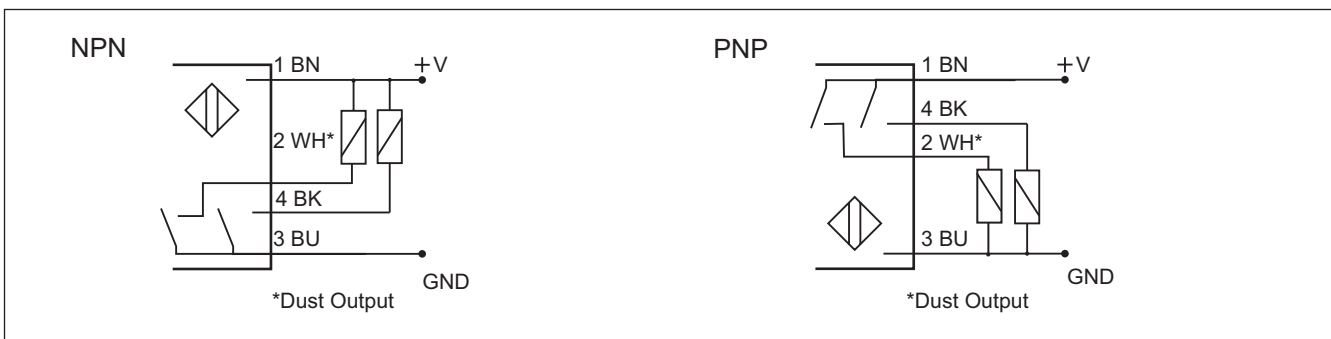

## Detection Diagram

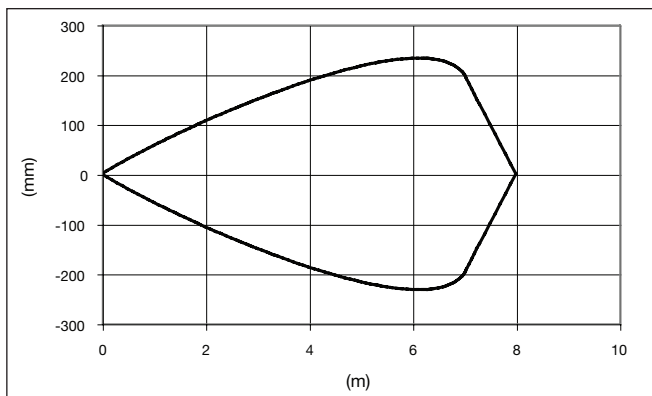

## Excess Gain

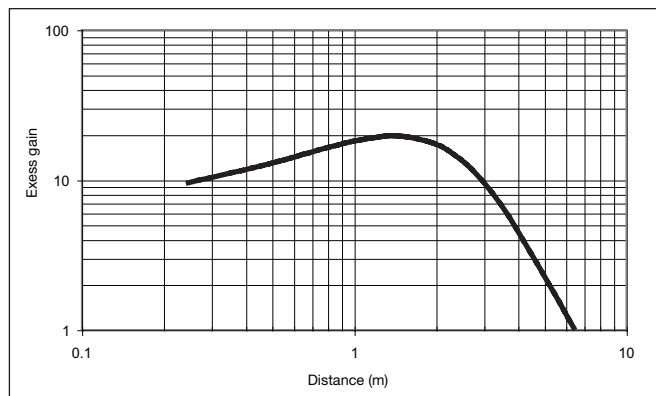

## Signal Stability Indication

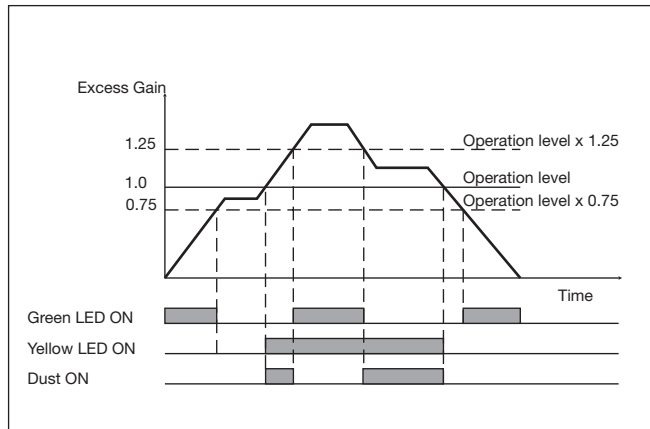

## Accessories

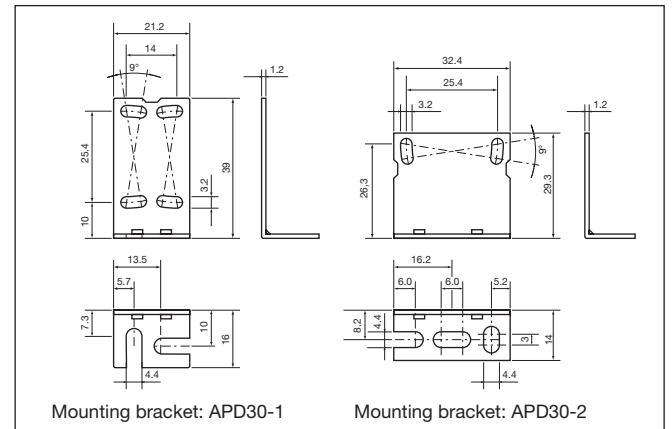

## Dimensions

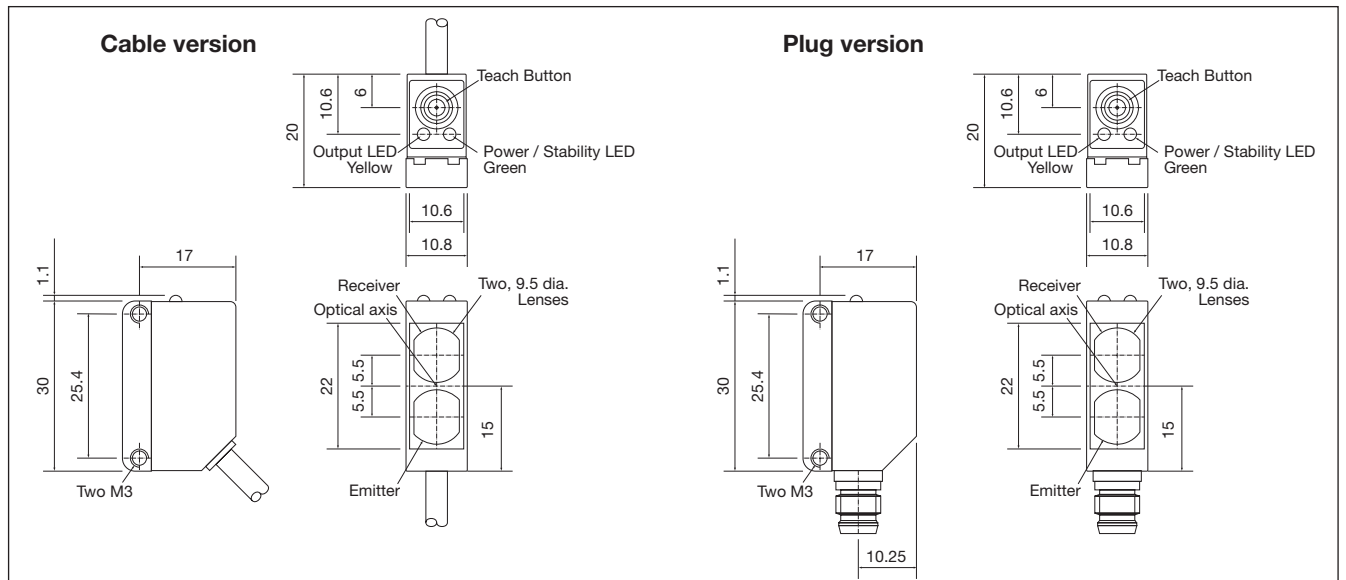

## Installation Hints

<p>To avoid interference from inductive voltage / current peaks, separate the proximity switch cables from any other power cables. E.g. Engine, contactor or solenoid cables</p> <p>Incorrect      Correct &gt; 100 mm</p>	<p>Relief of the cable strain</p> <p>Incorrect      Correct</p> <p>The cable should not be pulled</p>	<p>Protection of the sensing face</p> <p>Incorrect</p> <p>A proximity switch should not serve as mechanical stop</p>	<p>Sensor mounted on a mobile carrier</p> <p>Any repetitive flexing of the cable should be avoided</p>
--	---	--	--

## Delivery Contents

- Photoelectric switch: PD 30 CNP 06 ...
- Installation instruction
- Mounting bracket APD30-MB1
- **Packaging:** Cardboard box

## Accessories

- Reflector is to be purchased separately
- Mounting bracket APD30-MB2 to be purchased separately

## Teach functions

### Normal operation, optimized switching point.

1. Line up the sensor with the reflector. Yellow LED and Green LED are ON.
2. Press the button for 3 seconds until both LEDs flashes simultaneously.  
(The first switch point is stored)
3. Place the object between the sensor and reflector in the detection zone.
4. Press the button once and the sensor is ready to operate (Green LED ON, Yellow LED ON)  
(The second switch point is stored)

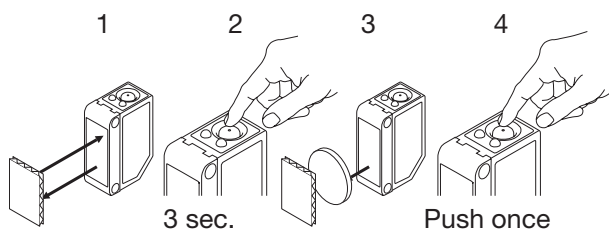

### For dynamic set-up (running process)

1. Line up the sensor with the reflector. Green LED is ON, status on the yellow LED is not important.
2. Press the button for 3 second until both LEDs flashes simultaneously.
3. Press the button a second time for at least one second, both LED's flashes fast siultainiously and keep the button pressed for at least one process cycle, release the button and the sensor is ready to operate (The second switch point is stored)

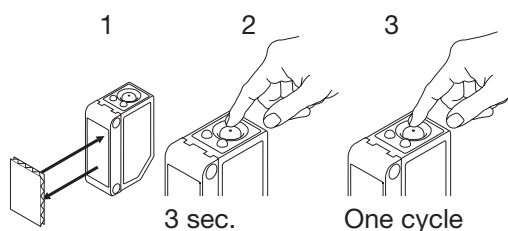

### For maximum sensing distance (default setting)

1. Line up the sensor with the reflector, place the object between the sensor and reflector in the detection zone. Yellow LED is OFF and Green LED is ON.
2. Press the button for 3 seconds until both LEDs flashes simultaneously.  
(The first switch point is stored)
3. Press the button a second time and the sensor is ready to operate (Green LED ON, Yellow LED ON)  
(The second switch point is stored)

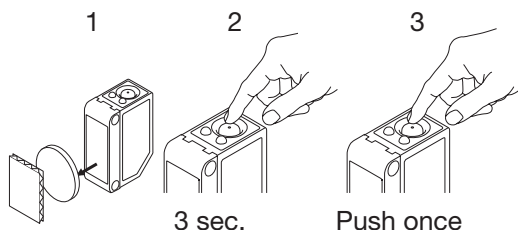

### For make or break set-up (N.O. or N.C.)

1. Press the button for 10 seconds, until the green LEDs flashes.
2. While the green LED flashes, the output is inverted each time the button is pressed. Yellow LED indicates N.O. function selected.  
If the button is not pressed within the next 10 seconds, the current output is stored.

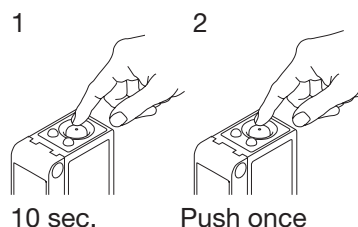

### For dust output (N.O. or N.C.)

1. Press the button for 15 seconds, until the yellow LEDs flashes.
2. While the yellow LED flashes, the dust output is inverted each time the button is pressed. Green LED indicates N.O. function selected.  
If the button is not pressed within the next 10 seconds, the current output is stored.

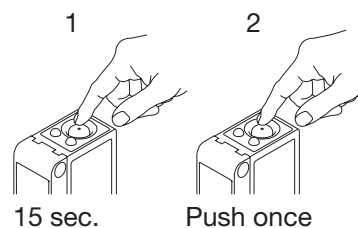

### For minimum detection overhead.

1. Line up the sensor with the reflector. Yellow LED and Green LED are ON.
2. Press the button for 3 seconds until both LEDs flashes simultaneously.  
(The first switch point is stored)
3. Press the button a second time and the sensor is ready to operate (Green LED ON, Yellow LED ON)  
(The second switch point is stored)

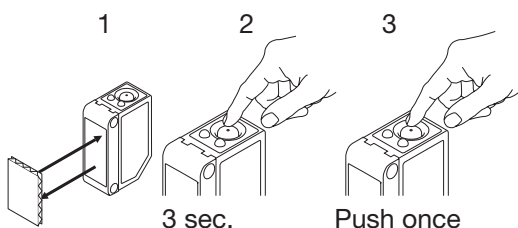

## X-ON Electronics

Largest Supplier of Electrical and Electronic Components

*Click to view similar products for [Photoelectric Sensors](#) category:*

*Click to view products by [Carlo Gavazzi](#) manufacturer:*

Other Similar products are found below :

[7442AD2X5FRX](#) [EX-19B-LP](#) [7443AR0X5FRX](#) [7452AD4D4NNX](#) [F3WD052C5M](#) [7655AR-04-F-1-2-RX](#) [7694ADE04DS2X](#) [FE7C-FRC6S-M](#) [PM-R24-R](#) [Q45VR2FPQ](#) [13104RQD07](#) [E3JUXM4MN](#) [E3L2DC4](#) [E3S3LE21](#) [E3SCT11M1J03M](#) [E3SDS20E21](#) [E3VDS70C43S](#)  
[E3XNM16](#) [BR23P](#) [HOA6563-001](#) [OJ-3307-30N8](#) [OS-311A-30](#) [P32013](#) [P34036](#) [P43004](#) [P56001](#) [P60001](#) [PB10CNT15PO](#) [S14132](#) [935286-000](#) [S52101](#) [S56258](#) [SH-21E](#) [FD-SN500](#) [FE7B-FDRB6-M](#) [SU-79](#) [T36342](#) [T40300](#) [T60001](#) [PD60CNX20BP](#) [FX2-A3R](#) [FX-302-HY](#) [FZS](#)  
[PM-T64W](#) [PX-22](#) [PZ2-51P](#) [CX-491-P-J](#) [CYNUTX10](#) [UZH802](#) [UZH803](#)