

Photoelectrics Retro-reflective, Polarized Type PD30CNP60....SA

CARLO GAVAZZI



- Miniature sensor range
- Range: 6 m
- Sensitivity adjustment by Potentiometer
- Modulated, red light 625 nm, polarized
- Supply voltage: 10 to 30 VDC
- Output: 100 mA, NPN or PNP preset
- Make and break switching function
- LED indication for output, stability and power ON
- Protection: reverse polarity, short circuit and transients
- Cable and plug versions
- Excellent EMC performance



Product Description

The PD30CNP60 sensor family comes in a compact 10 x 30 x 20 mm reinforced PMMA/ABS housing. The sensors are useful in applications where high-accuracy detection as well as small size is required. Compact housing and high power LED for excellent performance-size ratio.

The Potentiometer function for adjustment of the sensitivity makes the sensors highly flexible. The output type is preset (NPN or PNP), and the output switching function is NO and NC output.

Ordering Key

PD30CNP60NAM5SA

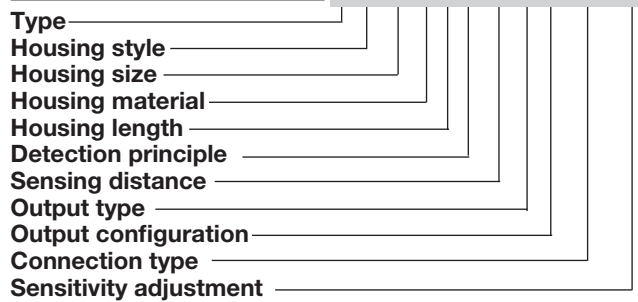

Type Selection

Housing W x H x D	Range S _n	Connection	Ordering no. NPN Make and break switching	Ordering no. PNP Make and break switching
10 x 30 x 20 mm	6 m	Cable	PD 30 CNP 60 NASA	PD 30 CNP 60 PASA
10 x 30 x 20 mm	6 m	Plug	PD 30 CNP 60 NAM5SA	PD 30 CNP 60 PAM5SA

Specifications

Rated operating distance (S_n) Ø 80 mm (ER4) reflector ER4060 reflector	≤ 6 m ≤ 4 m	OFF-state current (I_r)	≤ 100 µA
Blind zone	≤ 100 mm @ Ø80 mm (ER4) and ER4060 reflector	Voltage drop (U_d)	≤ 2 VDC @ I _e max
Sensitivity Electrical adjustment Mechanical adjustment	210° 240°	Protection	Short-circuit, reverse polarity and transients
Temperature drift	≤ 0.2%/°C	Light source	InGaAlP, LED, 625 nm
Hysteresis (H)	5% to 20%	Light type	Red, modulated
Rated operational volt. (U_B)	10 to 30 VDC (ripple included)	Emitter angle	± 2° @ half sensing distance
Ripple (U_{rpp})	≤ 10%	Light spot	110 mm @ 1.5 meters
Output current Continuous (I _a) Short-time (I)	≤ 100 mA ≤ 100 mA	Ambient light	≤ 10,000 lux
(max. load capacity 100 nF)		Operating frequency (f)	≤ 1000 Hz
No load supply current (I_o)	≤ 25 mA @ U _B max	Response time OFF-ON (t _{ON}) ON-OFF (t _{OFF})	≤ 0.5 ms ≤ 0.5 ms
Minimum operational current (I_m)	≤ 0.5 mA	Power ON delay (t_v)	≤ 30 ms
		Output function Open collector	NPN or PNP by sensor type



Specifications (cont.)

Output switching function Indication Output ON Signal stability ON and Power ON	N.O. and N.C.	Shock Rated insulation voltage	30 g / 11 ms, 3 pos, 3 neg per axis (IEC 60068-2-6, 60068-2-32)
	LED, yellow		≤ 500 VAC (rms)
Environment Installation category Pollution degree Degree of protection	III (IEC 60664/60664A; 60947-1)	Housing material Body Frontglas Trimmer shaft	ABS Light Grey PMMA Red POM Dark Grey
	3 (IEC 60664/60664A; 60947-1)		Connection Cable Plug
Degree of protection	IP 67 (IEC 60529; 60947-1)	Weight Cable version Plug version	
Ambient temperature Operating Storage	-25° to +60°C (-13° to +140°F) -40° to +70°C (-40° to +158°F)		CE-marking Approvals
Vibration	10 to 150 Hz, 1.0 mm/15 G (IEC 60068-2-6)		

Operation Diagram

tv = Power ON delay

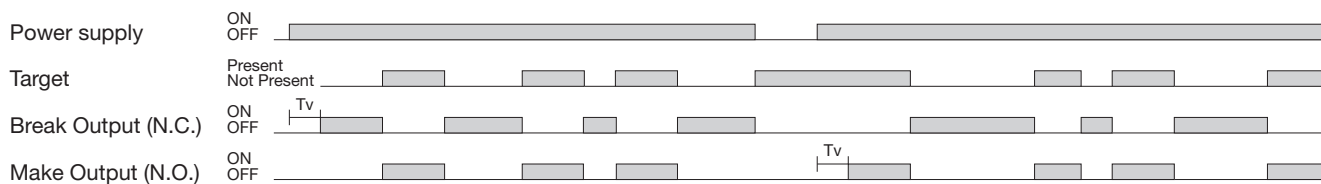

Signal Stability Indication

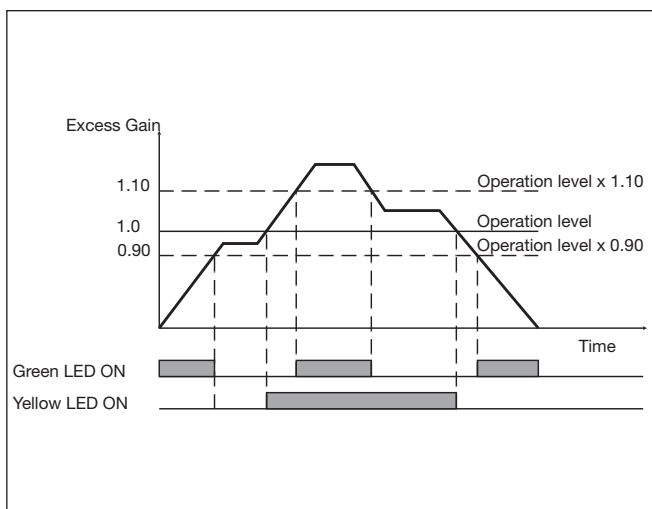

Wiring Diagrams

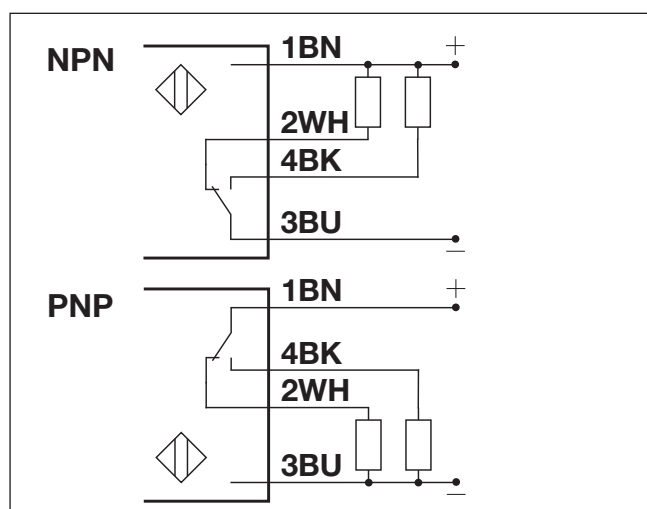

Detection Diagram

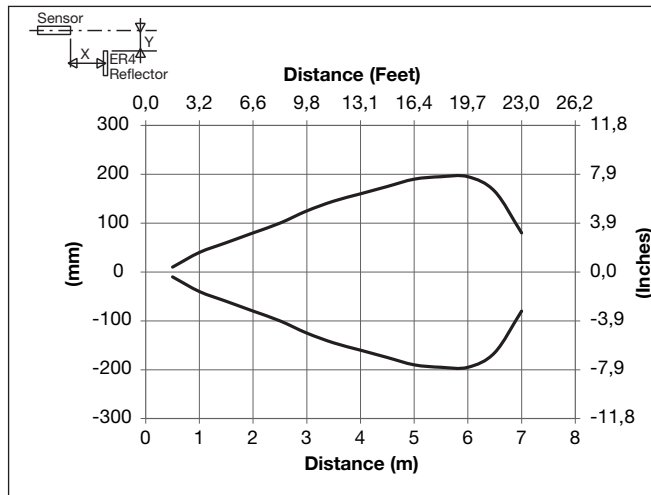

Excess Gain

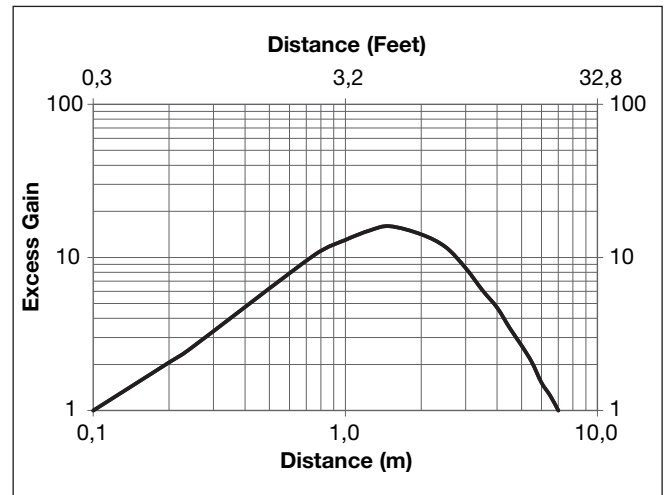

Dimensions

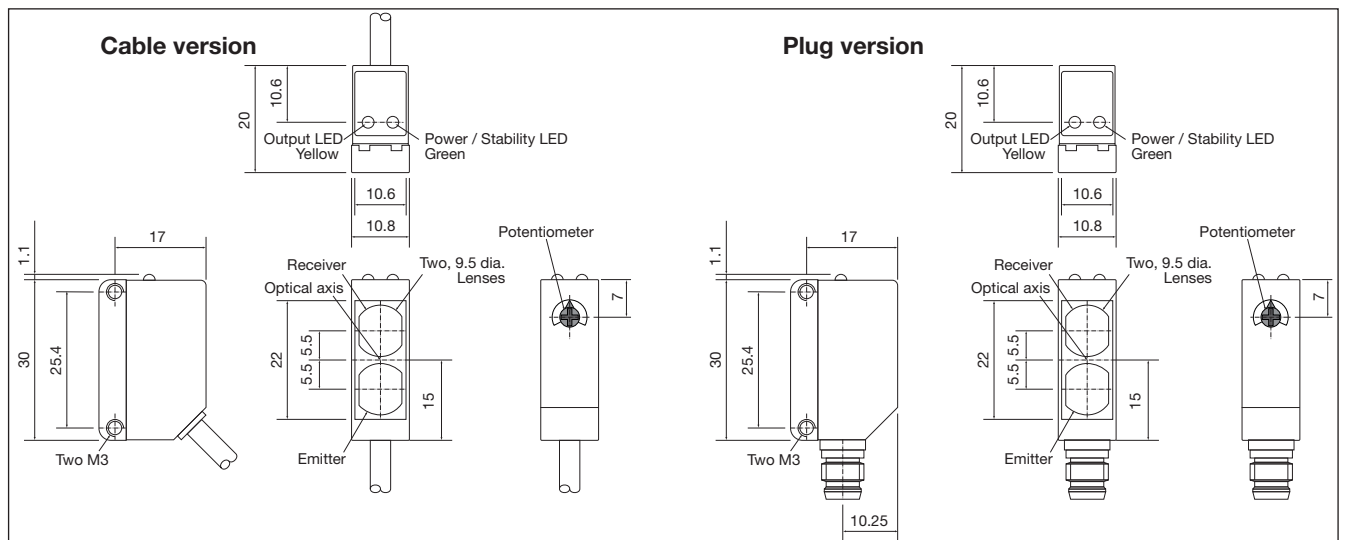

Installation Hints

<p>To avoid interference from inductive voltage / current peaks, separate the proximity switch cables from any other power cables. E.g. Engine, contactor or solenoid cables</p>	<p>Relief of the cable strain</p> <p>The cable should not be pulled</p>	<p>Protection of the sensing face</p> <p>A proximity switch should not serve as mechanical stop</p>	<p>Sensor mounted on a mobile carrier</p> <p>Any repetitive flexing of the cable should be avoided</p>
--	---	---	--

Accessories

- Mounting bracket APD30-MB1 or APD30-MB2 to be purchased separately.

Delivery Contents

- Photoelectric switch: PD30CNP60 ...
- Screwdriver
- **Packaging:** Plastic bag

X-ON Electronics

Largest Supplier of Electrical and Electronic Components

Click to view similar products for [Photoelectric Sensors](#) category:

Click to view products by [Carlo Gavazzi](#) manufacturer:

Other Similar products are found below :

[7442AD2X5FRX](#) [EX-19B-LP](#) [7443AR0X5FRX](#) [7452AD4D4NNX](#) [F3WD052C5M](#) [7655AR-04-F-1-2-RX](#) [7694ADE04DS2X](#) [FE7C-FRC6S-M](#) [PM-R24-R](#) [Q45VR2FPQ](#) [13104RQD07](#) [E3JUXM4MN](#) [E3L2DC4](#) [E3S3LE21](#) [E3SCT11M1J03M](#) [E3SDS20E21](#) [E3VDS70C43S](#)
[E3XNM16](#) [BR23P](#) [HOA6563-001](#) [OJ-3307-30N8](#) [OS-311A-30](#) [P32013](#) [P34036](#) [P43004](#) [P56001](#) [P60001](#) [PB10CNT15PO](#) [S14132](#) [935286-000](#) [S52101](#) [S56258](#) [SH-21E](#) [FD-SN500](#) [FE7B-FDRB6-M](#) [SU-79](#) [T36342](#) [T40300](#) [T60001](#) [PD60CNX20BP](#) [FX2-A3R](#) [FX-302-HY](#) [FZS](#)
[PM-T64W](#) [PX-22](#) [PZ2-51P](#) [CX-491-P-J](#) [CYNUTX10](#) [UZH802](#) [UZH803](#)