

Photoelectrics Retro-reflective Type PD30CNR06....RT

CARLO GAVAZZI



- Miniature sensor range
- Range: 6 m, with reflector
- Sensitivity adjustment by Teach-In programming
- Modulated, infrared light 880 nm
- Supply voltage: 10 to 30 VDC
- Output: 100 mA, NPN or PNP preset
- Make and break switching function programmable
- LED indication for output, stability and power ON
- Protection: reverse polarity, short circuit and transients
- Cable and plug versions
- Excellent EMC performance
- Remote teach features



Product Description

The PD30CNR06 sensor family comes in a compact 10 x 30 x 20 mm reinforced PMMA/ABS housing. The sensors are useful in applications where high-accuracy detection as well as small size is required. Compact housing and high power LED for excellent performance-size ratio.

The Teach-In function for adjustment of the sensitivity makes the sensors highly flexible. The output type is preset (NPN or PNP), and the output switching function is programmable (NO or NC). A remote teach feature allow the sensor to be set up from e.g. a PLC.

Ordering Key

PD30CNR06PPM5RT

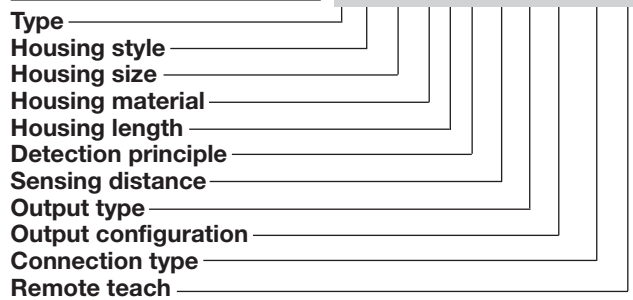

Type Selection

Housing W x H x D	Range S _n	Connection	Ordering no. NPN Make or break switching	Ordering no. PNP Make or break switching
10 x 30 x 20 mm	6 m	Cable	PD 30 CNR 06 NPRT	PD 30 CNR 06 PPRT
10 x 30 x 20 mm	6 m	Plug	PD 30 CNR 06 NPM5RT	PD 30 CNR 06 PPM5RT

Note: Reflectors to be ordered separately

Specifications

Rated operating distance (S_n)	Up to 6 m, with reflector Ø 80 mm (ER4) 4 m on ER4060 reflector	Light type	Infrared, modulated
Blind zone	100 mm	Sensing angle	± 2°
Sensitivity	Adjustable by Teach-In	Ambient light	10,000 lux
Temperature drift	≤ 0.1%/°C	Light spot	110 mm @ 1.5 m
Hysteresis (H) (differential travel)	≤ 10%	Operating frequency	1000 Hz
Rated operational volt. (U_B)	10 to 30 VDC (ripple included)	Response time	
Ripple (U_{rpp})	≤ 10%	OFF-ON (t _{ON})	≤ 0.5 ms
Output current		ON-OFF (t _{OFF})	≤ 0.5 ms
Continuous (I _a)	≤ 100 mA	Power ON delay (t_v)	≤ 300 ms
Short-time (I)	≤ 100 mA (max. load capacity 100 nF)	Output function	
No load supply current (I_o)	≤ 30 mA @ 24 VDC	NPN and PNP	Preset
Minimum operational current (I_m)	0.5 mA	NO/NC switching function	Set up by button
OFF-state current (I_r)	≤ 100 µA	Remote teach function	
Voltage drop (U_d)	≤ 2.4 VDC @ 100 mA	Teach on (push button active)	0 to 2.5 VDC (NPN) 5 to 30 VDC (PNP)
Protection	Short-circuit, reverse polarity and transients	Tamper proof	When activated more than 20 sec. the sensor goes into a Tamper proof mode.
Light source	GaAIAs, LED, 880 nm	Indication	
		Output ON	LED, yellow
		Signal stability ON and power ON	LED, green
		Environment	
		Installation category	III (IEC 60664/60664A; 60947-1)

Specifications are subject to change without notice (09.12.2008)



Specifications (cont.)

Pollution degree	3 (IEC 60664/60664A; 60947-1)	Housing material	ABS
Degree of protection	IP 67 (IEC 60529; 60947-1)	Body	PMMA, red
Ambient temperature		Front material	
Operating	-25° to +55°C (-13° to +131°F)	Connection	
Storage	-40° to +70°C (-40° to +158°F)	Cable	PVC, black, 2 m 4 x 0.14 mm ² , Ø = 3.3 mm M8, 4-pin (CON, 54-series)
Vibration	10 to 55 Hz, 0.5 mm/7.5 g (IEC 60068-2-6)	Plug	
Shock	30 g / 11ms, 3 pos, 3 neg per axis (IEC 60068-2-6, 60068-2-32)	Weight	With cable: 40 g With plug: 10 g
Rated insulation voltage	500 VAC (rms)	CE-marking	Yes
		Approvals	cULus (UL508)

Operation Diagram

tv = Power ON delay

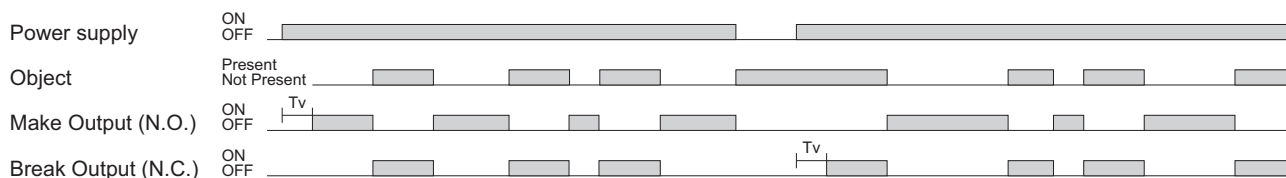

Wiring Diagrams

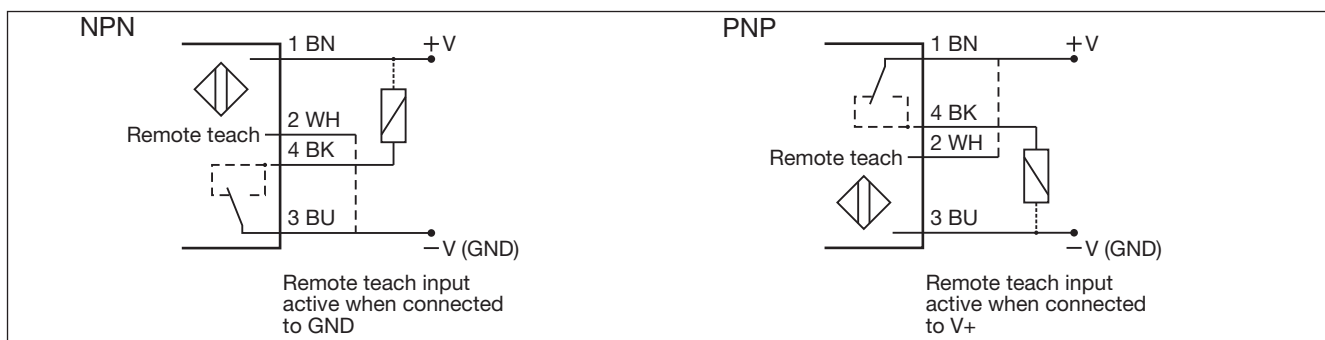

Detection Diagram

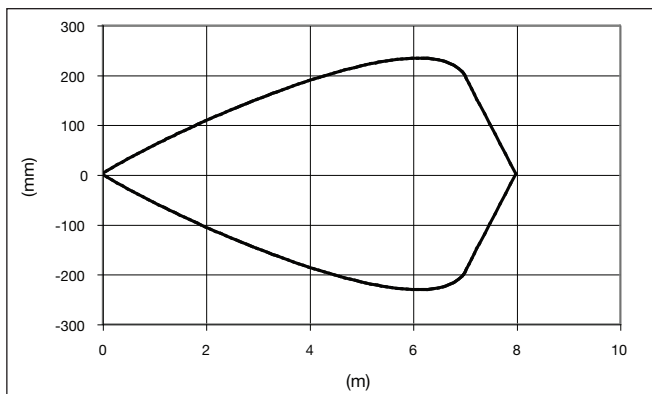

Excess Gain

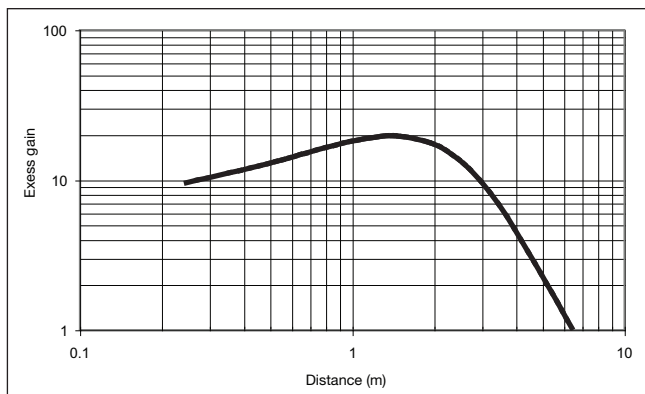

Signal Stability Indication

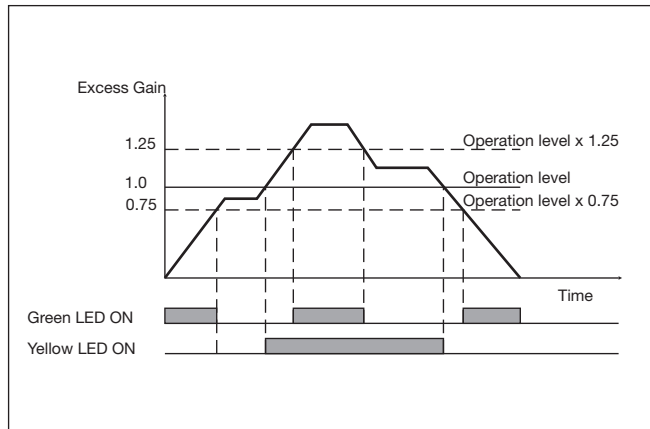

Accessories

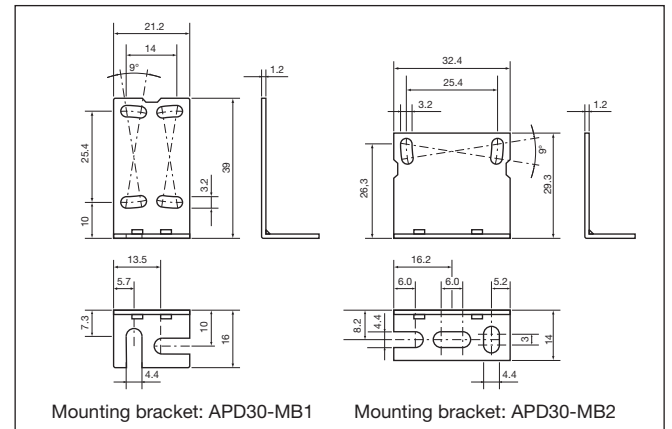

Dimensions

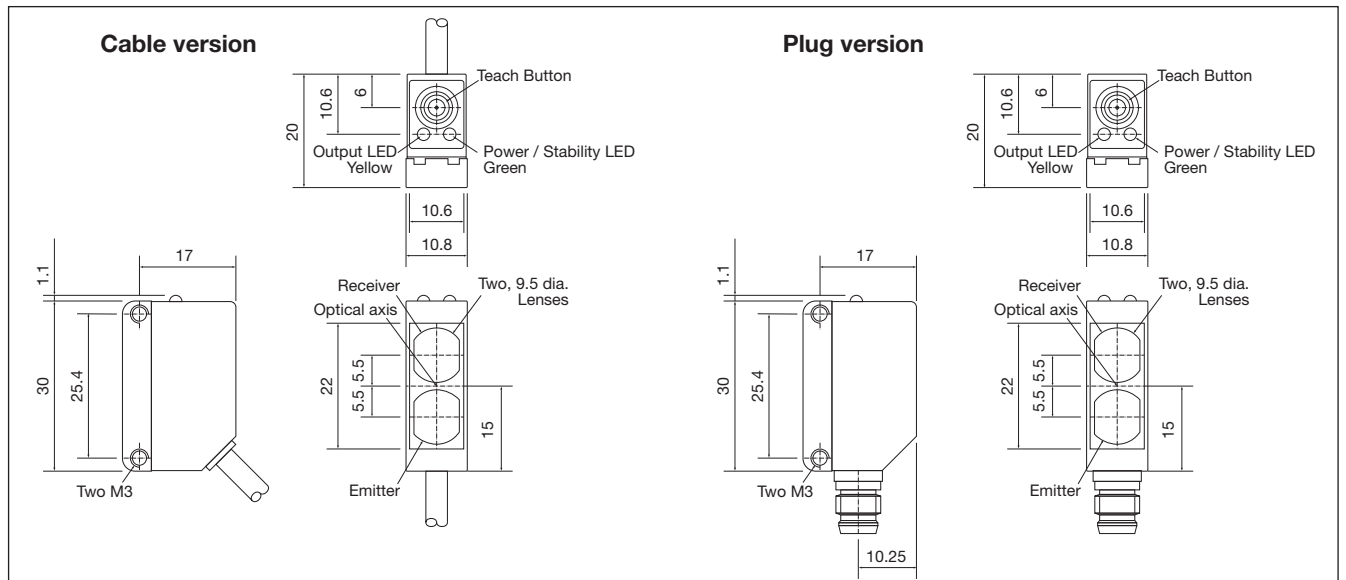

Installation Hints

<p>To avoid interference from inductive voltage / current peaks, separate the proximity switch cables from any other power cables. E.g. Engine, contactor or solenoid cables</p>	<p>Relief of the cable strain</p> <p>The cable should not be pulled</p>	<p>Protection of the sensing face</p> <p>A proximity switch should not serve as mechanical stop</p>	<p>Sensor mounted on a mobile carrier</p> <p>Any repetitive flexing of the cable should be avoided</p>
--	---	---	--

Delivery Contents

- Photoelectric switch: PD 30 CNR 06 ...
- Installation instruction
- Mountingbracket APD30-MB1
- **Packaging:** Cardboard box

Accessories

- Reflector is to be purchased separately
- Mounting bracket APD30-MB2 to be purchased separately

Teach functions

Normal operation, optimized switching point.

1. Line up the sensor with the reflector. Yellow LED and Green LED are ON.
2. Press the button for 3 seconds until both LEDs flashes simultaneously.
(The first switch point is stored)
3. Place the object between the sensor and reflector in the detection zone.
4. Press the button once and the sensor is ready to operate (Green LED ON, Yellow LED ON)
(The second switch point is stored)

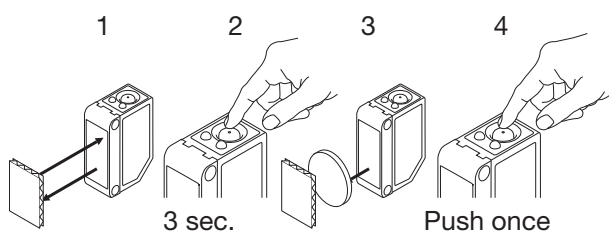

For dynamic set-up (running process)

1. Line up the sensor with the reflector. Green LED is ON, status on the yellow LED is not important.
2. Press the button for 3 second until both LEDs flashes simultaneously.
3. Press the button a second time for at least one second, both LED's flashes fast simultaneously and keep the button pressed for at least one process cycle, release the button and the sensor is ready to operate (The second switch point is stored)

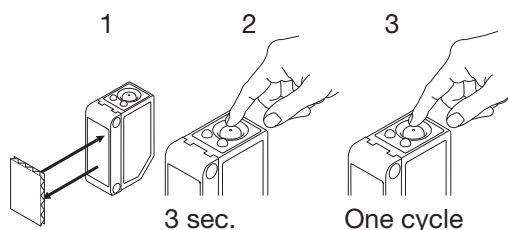

For maximum sensing distance (default setting)

1. Line up the sensor with the reflector, place the object between the sensor and reflector in the detection zone. Yellow LED is OFF and Green LED is ON.
2. Press the button for 3 seconds until both LEDs flashes simultaneously.
(The first switch point is stored)
3. Press the button a second time and the sensor is ready to operate (Green LED ON, Yellow LED ON)
(The second switch point is stored)

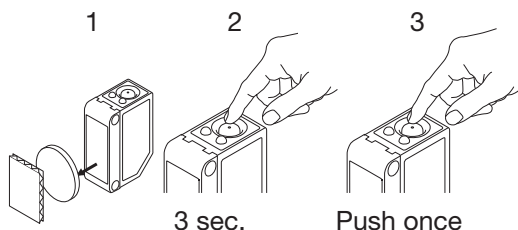

For make or break set-up (N.O. or N.C.)

1. Press the button for 10 seconds, until the green LEDs flashes.
2. While the green LED flashes, the output is inverted each time the button is pressed. Yellow LED indicates N.O. function selected.
If the button is not pressed within the next 10 seconds, the current output is stored.

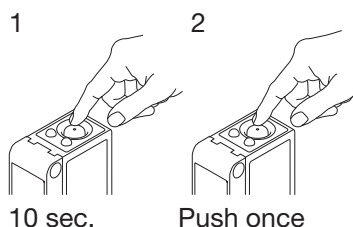

For minimum sensing distance

1. Line up the sensor with the reflector. Yellow LED and Green LED are ON.
2. Press the button for 3 seconds until both LEDs flashes simultaneously.
(The first switch point is stored)
3. Press the button a second time and the sensor is ready to operate (Green LED ON, Yellow LED ON)
(The second switch point is stored)

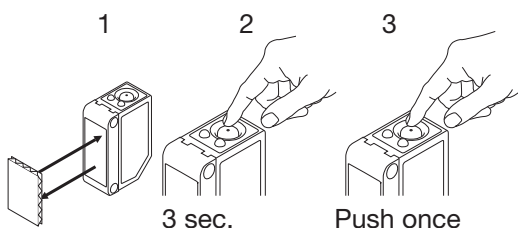

X-ON Electronics

Largest Supplier of Electrical and Electronic Components

Click to view similar products for [Photoelectric Sensors](#) category:

Click to view products by [Carlo Gavazzi](#) manufacturer:

Other Similar products are found below :

[7442AD2X5FRX](#) [EX-19B-LP](#) [EX-19SB-PN](#) [7443AR0X5FRX](#) [7452AD4D4NNX](#) [F3WD052C5M](#) [7655AR-04-F-1-2-RX](#) [7694ADE04DS2X](#)
[FE7C-FRC6S-M](#) [FX-305](#) [PM-R24-R](#) [Q45VR2FPQ](#) [13104RQD07](#) [E3JUXM4MN](#) [E3L2DC4](#) [E3S3LE21](#) [E3SCT11M1J03M](#) [E3SDS20E21](#)
[E3VDS70C43S](#) [E3XNM16](#) [BR23P](#) [HOA6563-001](#) [OJ-3307-30N8](#) [OS-311A-30](#) [P32013](#) [P34036](#) [P43004](#) [P56001](#) [P60001](#) [PB10CNT15PO](#)
[S14132](#) [935286-000](#) [S52101](#) [S56258](#) [SH-21E](#) [EX-L261-P](#) [FD-SN500](#) [FE7B-FDRB6-M](#) [SU-79](#) [T36342](#) [T40300](#) [T60001](#) [PD60CNX20BP](#)
[FX2-A3R](#) [FX-302-HY](#) [FZS](#) [PM-T64W](#) [PX-22](#) [PZ2-51P](#) [CX-491-P-J](#)