

# PD30CTBR35BPxxIO - IO-Link

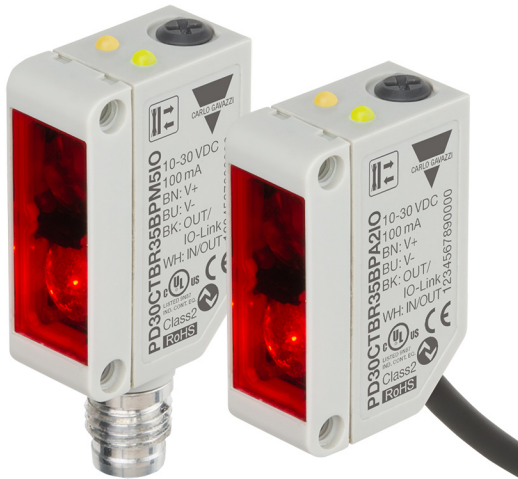

Photoelectric Background Suppression Long Range sensors with IO-Link communication



## Description

The PD30CTBR35BPxxIO are a part of the latest generation of high performance photoelectric sensors designed to solve most detection tasks due to the new IO-Link features. The sensors are implemented in the compact 10 x 20 x 30 mm ABS housing that are acknowledged world wide. New implemented functions with weight on functionality, reliability, Predictive maintenance make these sensors ideal for Industry 4.0.

## Benefits

- **Red Background suppression Long Range** sensor with IO-Link with a adjustable distance of 25 to 360 mm, either by trimmer or via IO-Link.
- **Application functions:** Pattern Recognition, Speed & Length, Divider function and Object & Gap Monitoring.
- **Neighbour Immunity**, selectable up to 3 sensors
- **Easy customization** to specific OEM requests by use of the build in IO-Link functionalities.
- **The output can be operated** either as a standard switching output or in IO-Link mode.
- **Fully configurable via output IO-Link v 1.1.** Electrical outputs can be configured as PNP / NPN / Push-Pull / External input, normally open or normally closed.
- **Timer functions** can be set, such as ON-delay, Off-delay, and one shots.
- **Logging functions:** Temperatures, detecting counter, power cycles and operating hours.
- **Detection modes** Single point, two point, windows and foreground suppression (FGS) mode.
- **Logic functions:** AND, OR, XOR and Gated SR-FF.
- **Analogue output:** In IO-Link mode the sensor will generate 16 bit analogue process data output representing various selectable process data such as received signal level.



## Applications

- Pattern Recognition:** An easy way to verify that a product is manufactured to the specification e.g. Furniture production where tabs or holes has to be with a defined pattern.
- Speed and Length:** Monitor the speed and length of an object on a conveyour for e.g. sorting on size.
- Divider function:** A de-central counting function that gives a signal when a preset count level is reached e.g. when a certain items are packed in a carton box it ask for a new box.
- Object and Gap Monitoring:** Function that can sort out good objects and gaps between them so e.g. a packaging machine only receive objects with the correct size and gaps.

## Main functions

- Detects presence or absence of objects that cut off the light from the emitter
- The detection distance is very independent of the colour of the object to detect.
- The sensor can be operated in IO-Link mode once connected to an IO-Link master or in standard I/O mode.



- Received sensing distance as process data.
- Neighbor inference protection.
- Sensing distance by potentiometer, teach by wire or by IO-link parameter.
- Quality of Run and Quality of Teach result.
- Temperature date for preventive maintenance.
- Front-end check for preventive maintenance.

**Adjustable parameters via IO-Link interface:**

- Sensing distance and hysteresis.
- Sensing modes: single point or two point or window mode.
- Timer functions, e.g.: On-delay, Off delay, One shot leading edge or trailing edge.
- Logic functions such as: AND, OR, X-OR and SR-FF.
- External input.
- Logging functions: Maximum temperatures, minimum temperatures, operating hours, operating cycles, power cycles, minutes above maximum temperature, minutes below minimum temperature, etc.
- Auto hysteresis
- Special functions: Pattern Recognition, Speed & Length, Divider function and Object & Gap Monitoring.

## References

**Product selection key**

**PD30CTBR35BP  IO**

Enter the code option instead of

Code	Option	Description
P	-	Sensing principle: Photoelectric sensor
D	-	Rectangular housing
30	-	Length of housing
C	-	Plastic housing
T	-	Top trimmer
B	-	Background suppression
R	-	Red light
35	-	Sensing distance: 350 mm
B	-	<b>Selectable functions:</b> NPN, PNP, Push-Pull, External Input (only pin 2) or External teach input (only pin 2)
P	-	<b>Selectable:</b> N.O. or N.C.
<input type="checkbox"/>	A2	Cable, 2 m
	M5	Connector M8
IO	-	IO-Link version

**Type selection**

Connec-tion	Housing	Light type	Code
Cable	Plastic housing	Red	<b>PD30CTBR35BPA2IO</b>
Plug	Plastic housing	Red	<b>PD30CTBR35BPM5IO</b>

## Structure

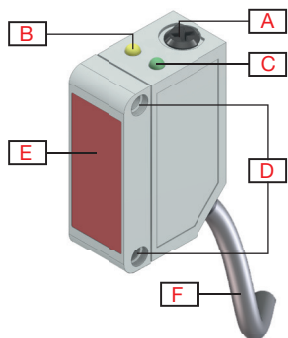

Fig. 1 Cable

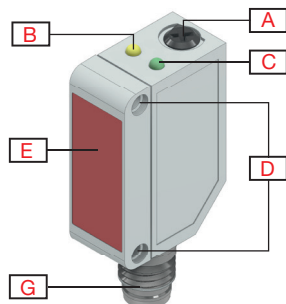

Fig. 2 Plug

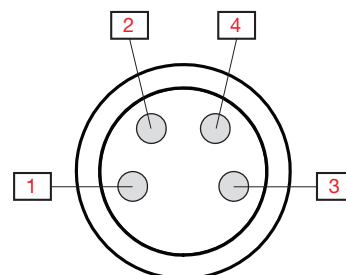

Fig. 3 "M8-plug" Pin numbers

<b>A</b>	Sensitivity adjustment (Top trimmer)	<b>G</b>	M8, 4-pin male connector
<b>B</b>	Yellow LED	<b>1</b>	Brown
<b>C</b>	Green LED	<b>2</b>	White
<b>D</b>	M3 Fixing holes for sensor mounting	<b>3</b>	Blue
<b>E</b>	Sensing window	<b>4</b>	Black
<b>F</b>	2 m, 4 wire PVC Ø 3.3 mm cable		



# Sensing

## Detection

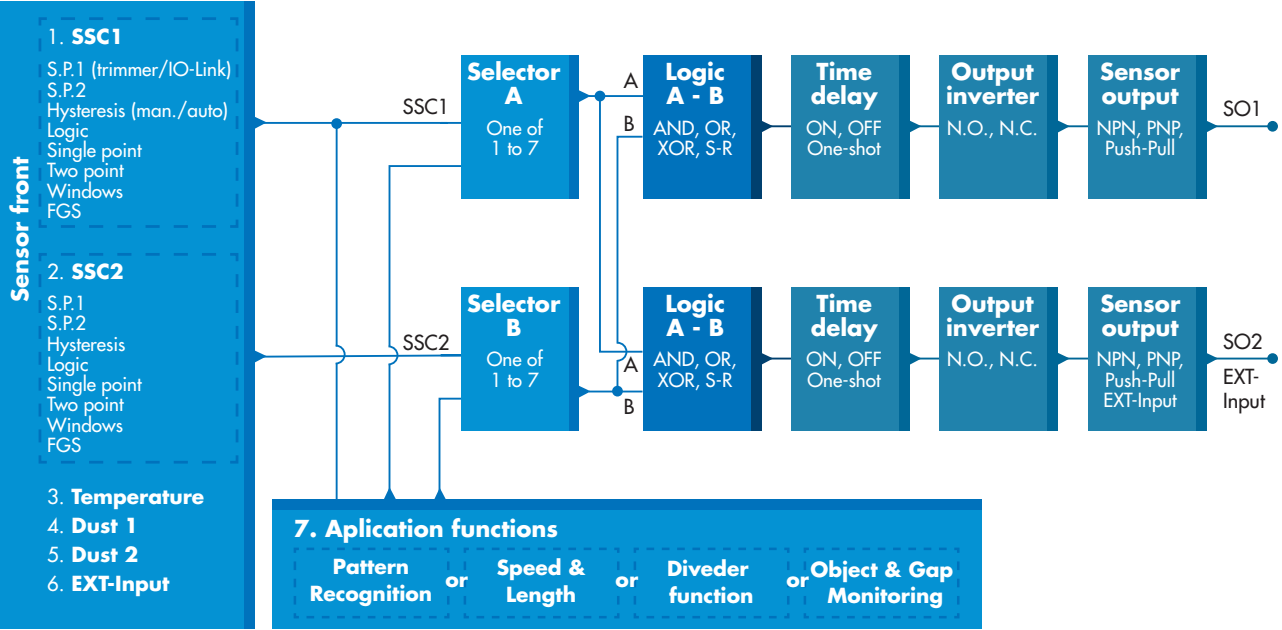



Sensor switching channel SSC1 and SSC2	<b>SSC1</b> <ul style="list-style-type: none"> <li>• Enabled</li> <li>• Disabled</li> </ul> <b>Factory settings:</b> Enabled	<b>SSC2</b> <ul style="list-style-type: none"> <li>• Enabled</li> <li>• Disabled</li> </ul> <b>Factory settings:</b> Enabled
Set Point 1 (SP1)	<ul style="list-style-type: none"> <li>• 20 ... 375</li> </ul> <b>Factory settings:</b> 350 (Approx. 350 mm @ Reference target 90% reflection)	
Set Point 2 (SP2)	<ul style="list-style-type: none"> <li>• 20 ... 375</li> </ul> <b>Factory settings:</b> 20 (Approx. 20 mm @ Reference target 90% reflection)	
Switching logic	<ul style="list-style-type: none"> <li>• High active</li> <li>• Low active</li> </ul> <b>Factory settings:</b> High active	
Switching mode	<b>SSC1</b> <ul style="list-style-type: none"> <li>• Deactivated</li> <li>• Single point mode</li> <li>• Two point mode</li> <li>• Windows mode</li> <li>• FGS mode</li> </ul> <b>Factory settings:</b> Single point mode	<b>SSC2</b> <ul style="list-style-type: none"> <li>• Deactivated</li> <li>• Single point mode</li> <li>• Two point mode</li> <li>• Windows mode</li> <li>• FGS mode</li> </ul> <b>Factory settings:</b> Single point mode
Rated operating distance (S <sub>n</sub> )	≤ 350 mm	Reference target, white paper with 90 % reflectivity, Size 200x200 mm
Maximum detection distance	≤ 350 mm	White object 90% reflection
	≤ 350 mm	Grey object 18% reflection
	≤ 350 mm	Black object 6% reflection
Cutoff distance	20...400 mm <b>Factory settings:</b> 400 mm Measured distance beyond Cutoff distance, will be truncated to Cutoff distance. Cutoff distance value will also be used when an object cannot be detected.	
Sensitivity control (selectable between)	<ul style="list-style-type: none"> <li>• IO-Link Adjustment (SSC1)</li> <li>• Trimmer Input (SSC1)</li> <li>• Teach by wire (SSC1)</li> </ul> <b>Factory settings:</b> Trimmer Input	
Sensitivity adjustment	23 mm ... 360 mm	Single-turn potentiometer
Blind zone	≤ 10 mm	White object 90% reflection
	≤ 12 mm	Grey object 18% reflection
	≤ 14 mm	Black object 6% reflection
Light source / Light type	620 nm / Red modulated	
Detection angle	± 1.2° @ half sensing distance	@ 100 mm
Light spot size	Ø 6.8 mm	@ 100 mm
Emitter beam angle	± 2.0°	@ 100 mm
Adjustable distance	20 ... 375 mm <b>Factory settings:</b> SP1 350 and SP2 20	White object 90% reflection
	20 ... 375 mm <b>Factory settings:</b> SP1 350 and SP2 20	Grey object 18% reflection
	20 ... 375 mm <b>Factory settings:</b> SP1 350 and SP2 20	Black object 6% reflection
Hysteresis (H) Manual Automatic	Adjustable by IO-Link <ul style="list-style-type: none"> <li>• 2 mm ... 375 mm</li> </ul> <b>Factory settings:</b> 24 mm	
Detection filter	This function can increase the immunity towards unstable targets and electromagnetic disturbances: Value can be set from 1 to 255. <b>Factory settings:</b> 1 (1 is max. operating frequency and 255 is min. operating frequency)	



<b>Mutual Inteferece Protection</b>	<ul style="list-style-type: none"> <li>• MIP Off</li> <li>• One channel</li> <li>• 2 channels - CH A</li> <li>• 2 channels - CH B</li> <li>• 3 channels - CH A</li> <li>• 3 channels - CH B</li> <li>• 3 channels - CH C</li> </ul>	<b>Factory settings:</b> MIP Off
-------------------------------------	---	----------------------------------

**Application functions**

<b>Selectable dedicated applications</b>	<ul style="list-style-type: none"> <li>• No application</li> <li>• Pattern Recognition</li> <li>• Speed and Length</li> <li>• Divider function</li> <li>• Object and Gap Monitoring</li> </ul>	<b>Factory settings:</b> No application
--	--	---

### Pattern Recognition

<b>Function description</b>	The Pattern recognition function detects a pattern (e.g. a row of holes or pins) and compare the order with a pre-taached reference pattern.	
<b>Conditions</b>	Two sensors (Main sensor and Trigger sensor) are needed for this function.	
<b>Settings</b>	<ul style="list-style-type: none"> <li>• The Trigger sensor has to detect the full length of the body that contains the pattern.</li> <li>• The Main sensor has to be aimed at the e.g. holes or pins that constitute the pattern.</li> </ul>	

### Speed and Length

<b>Function description</b>	This function is designed to monitor the length of an object as well as the speed of a conveyour belt. The actual value if the length in [mm] and the speed in [mm/s] are directly available on the IO-Link master.	
<b>Conditions</b>	Two sensors (Main sensor and Trigger sensor) are needed for this function.	
<b>Settings</b>	Distance between sensors.	25 ... 150 mm <b>Factory settings:</b> 100 mm

### Divider function

<b>Function description</b>	This function can be used to e.g. monitor how many items that are packed into a carton box. Once the preset number is reached the sensor gives an output so the full box can be replaced.	
<b>Conditions</b>	Only one sensor is needed for this function.	
<b>Settings</b>	A counter value must be set in the sensor.	
<b>Settings</b>	Counter limit.	1...60 000 <b>Factory settings:</b> 5



## Object and Gap Monitoring

<b>Function description</b>	This function is designed to monitor, that the length of an object and the gap between the following object on a conveyer belt, are within certain limits.	
<b>Conditions</b>	Only one sensor is needed for this function.	
<b>Settings</b>	An acceptable minimum and maximum time [ms] must be set for both the object size a gap size between two objects represented by the time it takes to pass the sensor.	
	Object minimum time.	10...60 000 ms <b>Factory settings:</b> 500 ms
	Object maximum time.	10...60 000 ms <b>Factory settings:</b> 10 000 ms
	Gap minimum time.	10...60 000 ms <b>Factory settings:</b> 500 ms
	Gap maximum time.	10...60 000 ms <b>Factory settings:</b> 10 000 ms
<b>Outputs</b>	Output 1 is active when an object is outside the set limits. Output 2 is active when the gap between two objects is outside the set limits.	

### Alarm settings

<b>Safe limits</b>	<b>SSC1</b> • 0 ... 100 % of actual SP <b>Factory settings:</b> 4%	<b>SSC2</b> • 0 ... 100 % of actual SP <b>Factory settings:</b> 5%
<b>Dust alarm</b>	Safe limits are used for dust alarm level.	
<b>Temperature alarm</b>	<ul style="list-style-type: none"> <li>• High threshold -50 ... +150 °C</li> <li>• Low threshold -50 ... +150 °C</li> </ul> <b>Factory settings:</b> High value 70 °C Low value -20 °C	

### Detection diagram

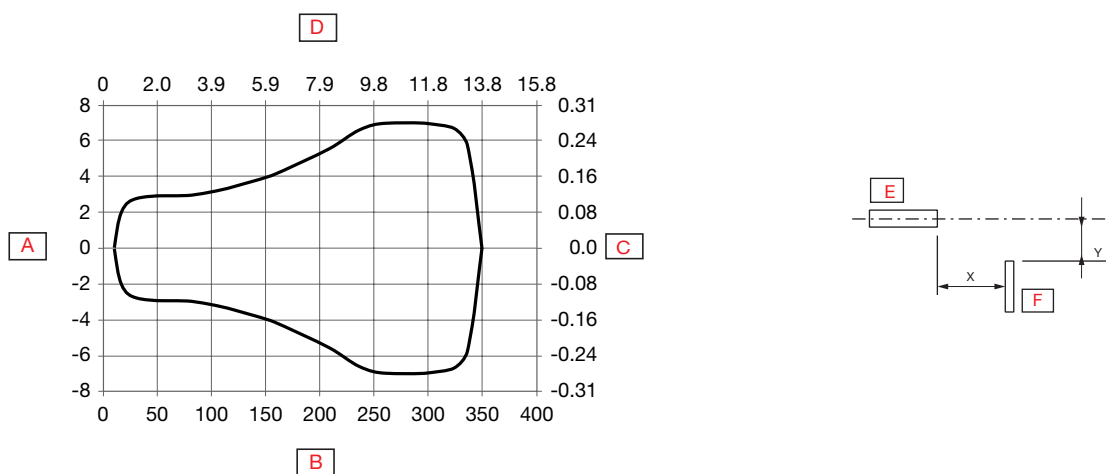

<b>A</b>	Detection width (mm)	<b>D</b>	Sensing range (inches)
<b>B</b>	Sensing range (mm)	<b>E</b>	Sensor
<b>C</b>	Detection width (inches)	<b>F</b>	Object 25 x 25 mm, White 90%



**Accuracy**

Temperature drift	≤ 0.2%/°C
-------------------	-----------

**Sensing conditions**

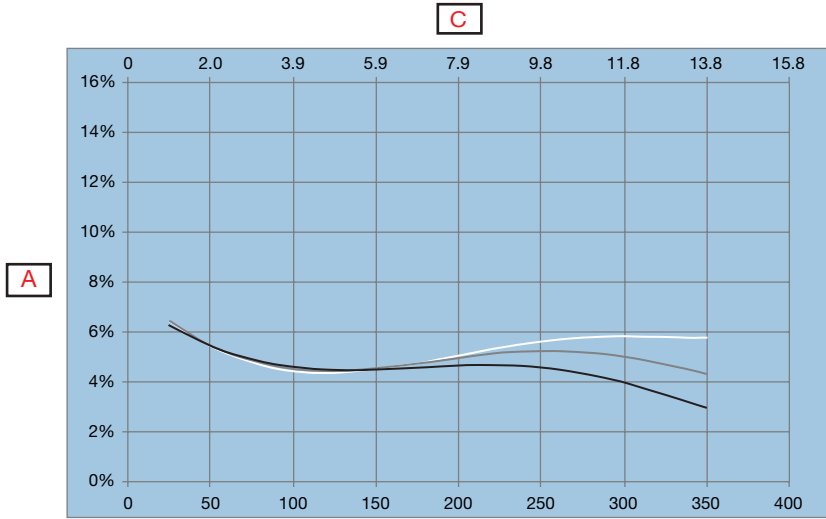

**Fig. 4 PD30CTBR35BPxxIO**

<b>A</b>	Distance from background (%)		(Black on white 6%/90%)
<b>B</b>	White background 90% (mm)		(Grey on white 18%/90%)
<b>C</b>	White background 90% (inches]		(White on white 90%/90%)





# Features

## ▶ Power Supply

Rated operational voltage ( $U_B$ )	10 ... 30 VDC (ripple included)
Ripple ( $U_{rpp}$ )	$\leq 10\%$
No load supply current ( $I_o$ )	$\leq 45$ mA @ $U_B$ min. $\leq 20$ mA @ $U_B$ max.
Power-ON delay ( $t_v$ )	$\leq 150$ ms

## ▶ Input selector

Input selector	<b>Channel A</b> <ul style="list-style-type: none"> <li>• Deactivated</li> <li>• SSC1</li> <li>• SSC2</li> <li>• Dust alarm 1</li> <li>• Dust alarm 2</li> <li>• Temperature alarm</li> <li>• External input</li> <li>• Application functions</li> </ul> <b>Factory settings: SSC1</b>	<b>Channel B</b> <ul style="list-style-type: none"> <li>• Deactivated</li> <li>• SSC1</li> <li>• SSC2</li> <li>• Dust alarm 1</li> <li>• Dust alarm 2</li> <li>• Temperature alarm</li> <li>• External input</li> <li>• Application functions</li> </ul> <b>Factory settings: SSC1</b>
----------------	--	--

## ▶ Logic functions

Logic functions	<b>Channel A + B for SO1</b> <ul style="list-style-type: none"> <li>• Direct</li> <li>• AND</li> <li>• OR</li> <li>• X-OR</li> <li>• SR-FF</li> </ul> <b>Factory settings: Direct</b>	<b>Channel A + B for SO2</b> <ul style="list-style-type: none"> <li>• Direct</li> <li>• AND</li> <li>• OR</li> <li>• X-OR</li> <li>• SR-FF</li> </ul> <b>Factory settings: Direct</b>
-----------------	---	---



**Time delays**

<b>Timer mode</b>	<b>For SO1</b> <ul style="list-style-type: none"> <li>• Disabled</li> <li>• ON delay</li> <li>• OFF delay</li> <li>• ON delay and OFF delay</li> <li>• One-shot leading edge</li> <li>• One-shot trailing edge</li> </ul> <b>Factory settings: Disabled</b>	<b>For SO2</b> <ul style="list-style-type: none"> <li>• Disabled</li> <li>• ON delay</li> <li>• OFF delay</li> <li>• ON delay and OFF delay</li> <li>• One-shot leading edge</li> <li>• One-shot trailing edge</li> </ul> <b>Factory settings: Disabled</b>
<b>Timer scale</b>	<b>For SO1</b> <ul style="list-style-type: none"> <li>• [ms]</li> <li>• [s]</li> <li>• [min]</li> </ul> <b>Factory settings: ms</b>	<b>For SO2</b> <ul style="list-style-type: none"> <li>• [ms]</li> <li>• [s]</li> <li>• [min]</li> </ul> <b>Factory settings: ms</b>
<b>Timer value</b>	<b>For SO1</b> <ul style="list-style-type: none"> <li>• 0 ... 32 767</li> </ul> <b>Factory settings: 0</b>	<b>For SO2</b> <ul style="list-style-type: none"> <li>• 0 ... 32 767</li> </ul> <b>Factory settings: 0</b>

**Outputs**

<b>Sensor output</b>	<b>For SO1 Pin 4 Black wire</b> <ul style="list-style-type: none"> <li>• Disabled output</li> <li>• NPN</li> <li>• PNP</li> <li>• Push-Pull</li> </ul> <b>Factory settings: PNP</b>	<b>For SO2 Pin 2 White wire</b> <ul style="list-style-type: none"> <li>• Disabled output</li> <li>• NPN</li> <li>• PNP</li> <li>• Push-Pull</li> <li>• External input, active high</li> <li>• External input, active low</li> <li>• External teach</li> <li>• Mute input</li> </ul> <b>Factory settings: PNP</b>
<b>Output Inverter</b>	<b>For SO1 Pin 4 Black wire</b> <ul style="list-style-type: none"> <li>• N.O.</li> <li>• N.C.</li> </ul> <b>Factory settings: N.O.</b>	<b>For SO2 Pin 2 White wire</b> <ul style="list-style-type: none"> <li>• N.O.</li> <li>• N.C.</li> </ul> <b>Factory settings: N.C.</b>
<b>Rated operational current (I<sub>o</sub>)</b>	≤ 100mA (continuous) pr. output 100 mA @ 100 nF Load (Short-time) pr. output	
<b>OFF-state current (I<sub>o</sub>)</b>	≤ 50 µA	
<b>Minimum operational current (I<sub>m</sub>)</b>	> 0,5 mA	
<b>Voltage drop (U<sub>d</sub>)</b>	≤ 1.0 VDC @ 100 mA	
<b>Protection</b>	Short circuit, reverse polarity, transients	
<b>Utilization category</b>	DC-12	Control of resistive loads and solid-state loads with optical isolation
	DC-13	Control of electromagnets
<b>Capacitive load</b>	100 nF @ 100 mA, 24 VDC	

**Operation diagram**

**For default factory sensor**

T<sub>v</sub> = Power-ON delay



Power supply	ON	
Target (Object)	Present	
Break output (N.C.)	ON	
Make output (N.O.)	ON	

**Response times**

Operating frequency (f)	≤ 500 Hz	
Response times	≤ 1 ms	OFF-ON (t <sub>ON</sub> )
	≤ 1 ms	ON-OFF (t <sub>OFF</sub> )

**Indication**

Green LED	Yellow LED	Power	Function
<b>SIO and IO-Link mode</b>			
ON	ON	ON	ON (stable)* SSC1
ON	OFF	ON	OFF (stable)* SSC1
OFF	OFF	OFF	OFF (Not stable) SSC1
Flashing 1 Hz (10% or 90% duty-cycle)	-	ON	Connected via IO-Link
-	Flashing 10 Hz 50% duty-cycle	ON	Output short-circuit
-	Flashing 0.5...20 Hz 50% duty-cycle	ON	Timer triggered indication
<b>SIO mode only</b>			
-	Flashing 1 HZ ON 100 ms OFF 900 ms	ON	External teach by wire. Only for single point mode.
-	Flashing 1 HZ ON 900 ms OFF 100 ms	ON	Teach time window (3 - 6 sec).
-	Flashing 10 HZ ON 50 ms OFF 50 ms Flashing for 2 sec	ON	Teach time out (12 sec).
-	Flashing 2 HZ ON 250 ms OFF 250 ms Flashing for 2 sec	ON	Teach successful.
<b>O-Link mode only</b>			
Flashing 1 HZ ON 900 ms OFF 100 ms	-	ON	Sensor is in IO-Link mode.
Flashing 2 Hz 50% duty-cycle		ON	Find my sensor

\*See operation diagram



**LED indication**

<b>LED indication selection</b>	<ul style="list-style-type: none"> <li>• LED indication inactive</li> <li>• LED indication active</li> <li>• Find my sensor</li> </ul> <p><b>Factory settings:</b> LED indication active</p>
---------------------------------	--

**Environmental**

<b>Ambient temperature</b>	-25° ... +60°C (-13° ... +140°F)	Operating <sup>1)</sup>
	-40° ... +85°C (-40° ... +185°F)	Storage <sup>1)</sup>
<b>Ambient humidity range</b>	35% ... 95%	Operating <sup>2)</sup>
	35% ... 95%	Storage <sup>2)</sup>
<b>Ambient light</b>	≤ 30 000 lux	@ 3000 ... 3200 °K
<b>Vibration</b>	10 ... 150 Hz, 1.0 mm/15 g	EN 60068-2-6
<b>Shock</b>	30 g <sub>n</sub> / 11 ms, 3 pos, 3 neg per axis	EN60068-2-27
<b>Drop test</b>	2 x 1 m and 100 x 0.5 m	EN 60068-2-31
<b>Rated insulation voltage (U<sub>i</sub>)</b>	50 VDC	
<b>Dielectric insulation voltage</b>	≥ 500 VAC rms	50/60 Hz for 1 min.
<b>Rated impulse withstand voltage</b>	>1 kV (with 500 Ω)	1.2/50 μs
<b>Pollution degree</b>	3	IEC60664, 60664A; EN60947-1
<b>Overvoltage category</b>	III	IEC60664; EN60947-1
<b>Degree of protection</b>	IP67	IEC60539; EN60947-1
<b>NEMA Enclosure Types</b>	1	NEMA 250

<sup>1)</sup> Do not bend the cable in temperatures below -10°C

<sup>2)</sup> With no icing or condensation

**EMC**

<b>Electrostatic discharge immunity test</b>	± 8 kV @ air discharge or ± 4 kV @ contact discharge	IEC 61000-4-2; EN60947-1
<b>Electromagnetic field immunity</b>	10 V/m	IEC 61000-4-3; EN60947-1
<b>Fast transient immunity</b>	±2 kV / 5 kHz	IEC 61000-4-4; EN60947-1
<b>Wire-conducted noise</b>	10 Vrms	IEC 61000-4-3; EN60947-1
<b>Power frequency magnetic field immunity test</b>	Continuous: >30 A/m, 28 μ tesla Short-time: >300 A/m, 280 μ tesla	IEC 61000-4-8; EN60947-1



**Diagnostic parameters**

Function	Unit	Range
<b>Sensor Diagnostics</b>		
Frontend Failure	0	0 or 1
Memory Failure	0	0 or 1
<b>Temperature Diagnostics</b>		
Current temperature	[°C]	-50 ... +150
Maximum temperature - All time high	[°C]	-50 ... +150
Minimum temperature - All time low	[°C]	-50 ... +150
Maximum temperature - Since last power-up	[°C]	-50 ... +150
Minimum temperature - Since last power-up	[°C]	-50 ... +150
Minutes above Maximum Temperature	[min]	0 ... 2 147 483 647
Minutes below Minimum Temperature	[min]	0 ... 2 147 483 647
<b>Operating Diagnostic</b>		
Operating Hours	[h]	0 ... 2 147 483 647
Number of Power Cycles	[cycles]	0 ... 2 147 483 647
Detection counter SSC1	[cycles]	0 ... 2 147 483 647
Maintenance event counter	[cycles]	0 ... 2 147 483 647
Download counter	[counts]	0 ...65 536
Quality of Teach	-	0 ... 255%
Quality of Run	-	0 ... 255%
Excess gain		0.00 ... 1 000.00
Error Count	[counts]	0 ...65 536
Device Status	0 = Device is operating properly 1 = Maintenance required 2 = Out-of-specification 3 = Functional-Check 4 = Failure <b>Factory settings: 0</b>	

**Events Configuration**

Events	Factory default setting
Maintenance Event	Inactive
Temperature fault event	Inactive
Temperature over-run	Inactive
Temperature under-run	Inactive
Short circuit	Inactive

**Observation menu**

Process Data	Factory default setting
Analogue value	Analogue value Inactive
	Analogue value normal <b>Factory settings</b>
	Analogue value as Object Length
	Analogue value as Object Speed
	Analogue value as Counter value
Excess gain	Inactive
SO1, Switching output 1	Active
SO2, Switching output 2	Active
SSC1, Sensor switching channel 1	Inactive
SSC2, Sensor switching channel 2	Inactive
DA1, Dust alarm SSC1	Inactive
DA2, Dust alarm SSC2	Inactive
TA, Temperature alarm	Inactive
SC, Short circuit	Inactive
AFO1, Application functions output 1	Inactive

**Process data structure**

4 Bytes, Analogue value 16 ... 31 (16 bit)

Byte	31	30	29	28	27	26	25	24
Byte 0	<b>MSB</b>	-	-	-	-	-	-	-
	23	22	21	20	19	18	17	16
Byte 1	-	-	-	-	-	-	-	<b>LSB</b>
	15	14	13	12	11	10	9	8
Byte 2	-	-	<b>SC</b>	<b>TA</b>	<b>DA2</b>	<b>DA1</b>	<b>SSC2</b>	<b>SSC1</b>
	7	6	5	4	3	2	1	0
Byte 3	<b>AFO1</b>	-	-	-	-	-	<b>SO2</b>	<b>SO1</b>
	-	-	-	-	-	-	-	-

## Mechanics/electronics

### ▶ Connection

<b>Cable</b>	2 m, 4-wire 4 x 0.14 mm <sup>2</sup> , Ø = 3.3 mm, PVC, Black
<b>Plug</b>	M8, 4-pin, male

### ▶ Wiring

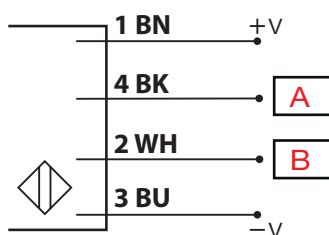

BN	BK	WH	BU	A	B
Brown	Black	White	Blue	OUT/IO-Link	IN/OUT

### ▶ Housing

<b>Body</b>	ABS	
<b>Front glass</b>	PMMA, Red	
<b>Trimmer shaft</b>	POM, Grey	
<b>Indication</b>	TPU, Transparent	
<b>Sealing</b>	NBR70	
<b>Dimensions</b>	10 x 30 x 20 mm	
<b>Weight</b>	≤ 50 g	Cable version
	≤ 20 g	Plug version



Dimensions

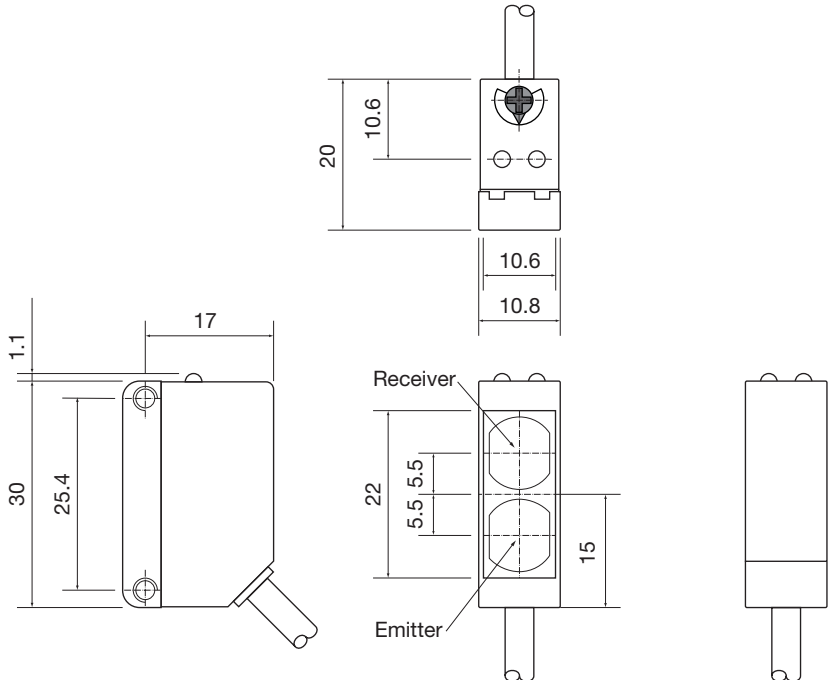

Fig. 5 Cable

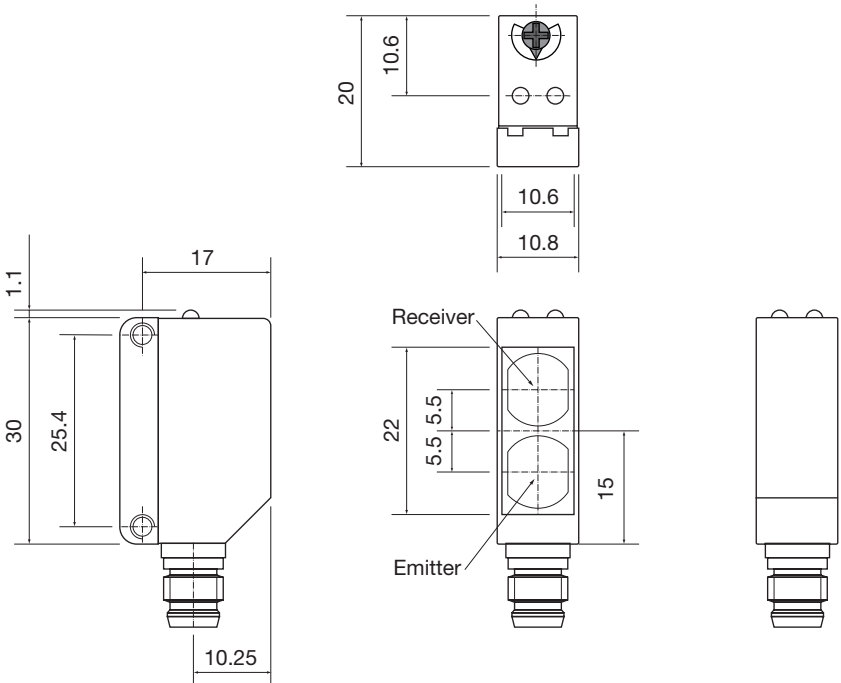



Fig. 6 Plug



## Compatibility and conformity

### Approvals and markings

<b>General reference</b>	Sensor designed according to EN60947-5-2	
<b>MTTF<sub>d</sub></b>	138.5 years	EN ISO 13849-1, SN 29500
<b>CE-marking</b>		
<b>Approvals</b>		

### IO-Link

<b>IO-Link revision</b>	1.1
<b>Transmission rate</b>	COM2 (38.4 kbaud)
<b>SDCI-Norm</b>	IEC 61131-9
<b>Profile</b>	Smart sensor profile 2nd edition, common profile
<b>Min. cycle time</b>	5 ms
<b>SIO mode</b>	Yes
<b>Min. master port class</b>	A (4-pin)
<b>Process data length</b>	32 bit



## Delivery contents and accessories



### ▶ Delivery contents

- Photoelectric switch: PD30CTBR35BPxxIO
- Screwdriver
- Packaging: Plastic bag

### ▶ Accessories

- Mounting bracket: APD30-MB1 or APD30-MB2 to be purchased separately
- Connector type: CO..54NF... series to be purchased separately

### ▶ Further information

Information	Where to find it	QR
IO-Link manual	<a href="http://cga.pub/?93ec5c">http://cga.pub/?93ec5c</a>	
Mounting brackets	<a href="http://cga.pub/?6fa29a">http://cga.pub/?6fa29a</a>	
Connectors	<a href="http://cga.pub/?0aae3e">http://cga.pub/?0aae3e</a>	



COPYRIGHT ©2021  
 Content subject to change. Download the PDF: [www.gavazziautomation.com](http://www.gavazziautomation.com)

## X-ON Electronics

Largest Supplier of Electrical and Electronic Components

*Click to view similar products for [Photoelectric Sensors](#) category:*

*Click to view products by [Carlo Gavazzi](#) manufacturer:*

Other Similar products are found below :

[7442AD2X5FRX](#) [EX-19B-LP](#) [EX-19SB-PN](#) [7443AR0X5FRX](#) [7452AD4D4NNX](#) [F3WD052C5M](#) [7655AR-04-F-1-2-RX](#) [7694ADE04DS2X](#)  
[FE7C-FRC6S-M](#) [FX-305](#) [PM-R24-R](#) [Q45VR2FPQ](#) [13104RQD07](#) [E3JUXM4MN](#) [E3L2DC4](#) [E3S3LE21](#) [E3SCT11M1J03M](#) [E3SDS20E21](#)  
[E3VDS70C43S](#) [E3XNM16](#) [BR23P](#) [HOA6563-001](#) [OJ-3307-30N8](#) [OS-311A-30](#) [P32013](#) [P34036](#) [P43004](#) [P56001](#) [P60001](#) [PB10CNT15PO](#)  
[S14132](#) [935286-000](#) [S52101](#) [S56258](#) [EX-L261-P](#) [FD-SN500](#) [FE7B-FDRB6-M](#) [SU-79](#) [T36342](#) [T40300](#) [T60001](#) [PD60CNX20BP](#) [FX-302-](#)  
[HY](#) [FZS](#) [PM-T64W](#) [PX-22](#) [PZ2-51P](#) [CX-491-P-J](#) [CYNUTX10](#) [UZB802](#)