

# PD30ETD02xxWE



## Photoelectrics, Extreme wide angle - Diffuse reflective



### Main features

- Miniature sensor range
- Sensing range: 200 mm
- Sensitivity adjustment by potentiometer
- Modulated, infrared light 850 nm
- Supply voltage: 10 to 30 VDC
- Output: 100 mA, NPN or PNP preset
- Make and break switching function
- LED indication for output, stability and power ON
- Protection: reverse polarity, short circuit and transients
- Cable and plug versions
- Excellent EMC performance
- The extremely wide-angled light beam eliminates false detection due to e.g. large holes in a PCB
- Ecolab

### Description

The PD30ET... stainless steel sensors are built with high-quality materials and designed for harsh environments.

They are designed for use in environments where high-pressure cleaning, cleaning agents and disinfectants are used on a daily basis.

The strong stainless steel (AISI316L) together with high-quality plastic materials like PEEK, PPSU, and PES sealings of FKM ensure a safe and excellent mechanical resistance.

The sensor housing has the IP69K rating as well as approval by ECOLAB for cleaning and disinfection agents.

The compact sensor design is ideally suited to confined spaces.

### Main functions

- Detects presence or absence of objects by detecting reflected light energy from the object

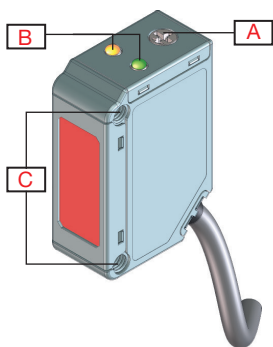

Fig. 1 Cable

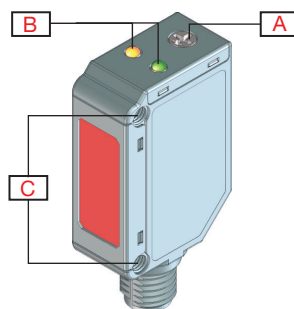

Fig. 2 Plug

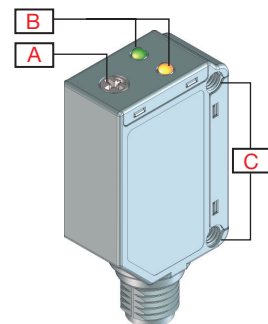

Fig. 3 Back

Element	Component	Function
A	Potentiometer	Adjustment
B	2 LEDs	Green LED: Power ON / Signal stability. Yellow LED: Output
C	2 M3	Fixing holes for sensor mounting

# Sensing

## Detection

<b>Rated operating distance (S<sub>n</sub>)</b>	≤ 200 mm	Reference target, white paper with 90 % reflectivity, Size 200x200 mm
<b>Sensitivity adjustment</b>	20 mm ... 200 mm	Single-turn potentiometer
	210°	Electrical adjustment
	240°	Mechanical adjustment
<b>Blind zone</b>	≤ 0 mm @ S <sub>n</sub> max	Reference target, white paper with 90 % reflectivity, Size 200x200 mm
<b>Hysteresis</b>	5% ... 20%	
<b>Light source</b>	850 nm	Infrared
<b>Light type</b>	Infrared modulated	
<b>Detection angle</b>	± 20°	@ 100 mm (half sensing distance)
<b>Light spot size</b>	85 mm	@ 100 mm (half sensing distance)
<b>Emitter beam angle</b>	± 23.0°	@ 100 mm (half sensing distance)

## Accuracy

<b>Temperature drift</b>	≤ 0.2%/°C
--------------------------	-----------

## Detection diagram

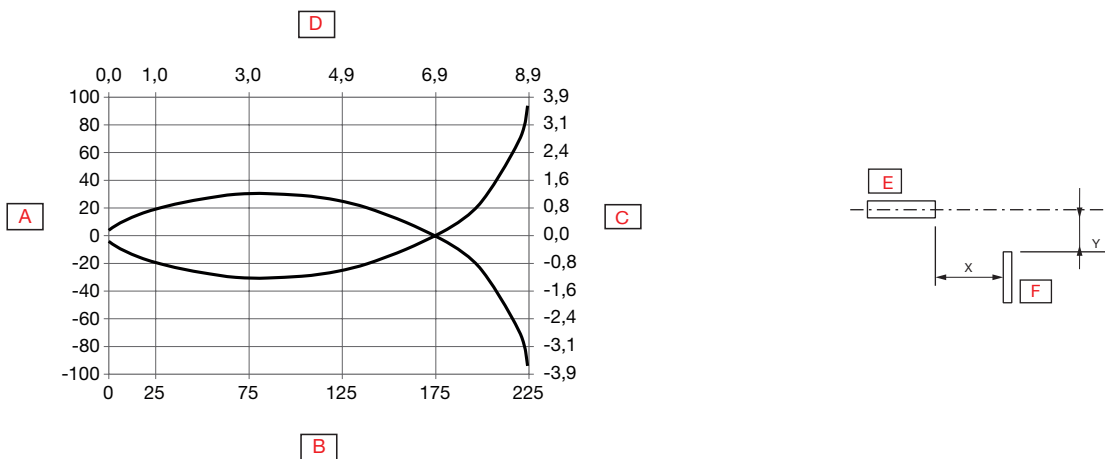

<b>A</b>	Detection width (mm)	<b>E</b>	Sensor
<b>B</b>	Distance (mm)	<b>F</b>	Object
<b>C</b>	Detection width (inches)		
<b>D</b>	Distance (inches)		



**Excess gain**

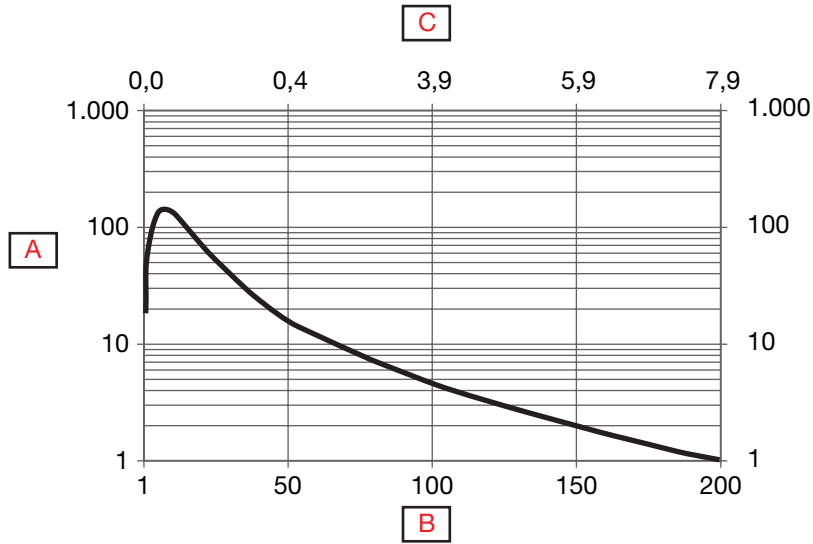

<b>A</b>	Excess gain	<b>C</b>	Distance (inches)
<b>B</b>	Distance (mm)		



# Features

## Power Supply

Rated operational voltage ( $U_B$ )	10 ... 30 VDC (ripple included)
Ripple ( $U_{rpp}$ )	$\leq 10\%$
No load supply current ( $I_o$ )	$\leq 25$ mA @ $U_B$ max
Power-ON delay ( $t_v$ )	$\leq 30$ ms

## Outputs

Output functions	NPN or PNP by sensor type	Open collector
Output switching function	N.O. and N.C.	
Output current	$< 100$ mA	Continuous( $I_o$ )
	$\leq 100$ mA @ Load: 100 nF	Short-time ( $I$ )
Minimum operational current ( $I_m$ )	0.5 mA	
OFF-state current( $I_r$ )	100 $\mu$ A	
Voltage drop ( $U_d$ )	2 VDC @ ( $I_o$ ) max.	
Protection	Short circuit, reverse polarity and transients	
Utilization category	DC-12	Control of resistive loads and solid-state loads with optical isolation
	DC-13	Control of electromagnets

## Operation diagram

$T_v$  = Power-ON delay



## Response times

Operating frequency (f)	$\leq 1000$ Hz	
Response times	$\leq 0.5$ ms	OFF-ON ( $t_{ON}$ )
	$\leq 0.5$ ms	ON-OFF ( $t_{ON}$ )



**Indication**

Green LED	Yellow LED	Power	Output
ON	OFF	ON	OFF (stable)*
OFF	OFF	ON or OFF	OFF
OFF	ON	ON	ON
ON	ON	ON	ON (stable)*

\*See signal stability curve

**Signal stability indication**

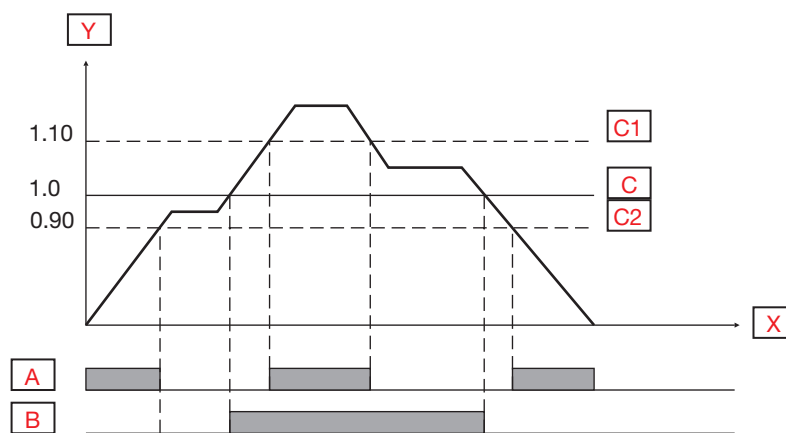

<b>A</b>	Green LED ON	<b>C1</b>	Operation level x 1.10
<b>B</b>	Yellow LED OFF	<b>C</b>	Operation level
<b>X</b>	Time	<b>C2</b>	Operation level x 0.90
<b>Y</b>	Excess gain		

**Environmental**

<b>Ambient temperature</b>	-25° ... +60°C (-13° ... +140°F)	Operating, Cable version <sup>1)</sup>
	-40° ... +60°C (-40° ... +140°F)	Storage Plug version <sup>1)</sup>
	-40° ... +70°C (-40° ... +158°F)	Storage
<b>Ambient light</b>	≤ 10 000 lux	@ 3000 ... 3200 °K
<b>Vibration</b>	10 ...150 Hz, 1.0 mm/15 g	EN 60068-2-6
<b>Shock</b>	30 g <sub>n</sub> / 11ms, 6 pos, 6 neg per axis	EN60068-2-27
<b>Drop test</b>	2 x 1 m and 100 x 0.5 m	EN 60068-2-31
<b>Rated insulation voltage (U<sub>i</sub>)</b>	50 VDC	
<b>Dielectric insulation voltage</b>	≥ 500 VAC rms	50/60 Hz for 1 min.
<b>Rated impulse withstand voltage</b>	≥1 kV	1.2/50 μs
<b>Pollution degree</b>	3	EN60947-1
<b>Overvoltage category</b>	III	IEC60664; EN60947-1
<b>Degree of protection</b>	IP68 @ 2m and 20 h	IEC60539; EN60947-1
	IP69K	DIN 40050-9
<b>NEMA Enclosure Types</b>	1, 2, 4, 4X, 5, 6, 6P	NEMA 250
<b>Ambient humidity range</b>	35% ... 95%	Operating <sup>2)</sup>
	35% ... 95%	Storage <sup>2)</sup>



- 1) Do not bend the cable in temperatures below  $-10^{\circ}\text{C}$   
 2) With no icing or condensation

**EMC**

<b>Electrostatic discharge immunity test</b>	$\pm 8 \text{ kV @ air discharge or}$ $\pm 4 \text{ kV @ contact discharge}$	IEC 61000-4-2
<b>Radiated radio-frequency electromagnetic field immunity test (80 MHz ... 1 GHz and 1.4 GHz ... 2 GHz)</b>	10 V/m	IEC 61000-4-3
<b>Electrical fast transient/Burst immunity test</b>	2 kV / 5 kHz using the capacitive coupling clamp	IEC 61000-4-4
<b>Conducted disturbances induced by radio-frequency fields immunity test (150 kHz ... 80 MHz)</b>	10 Vrms	IEC 61000-4-6
<b>Power frequency magnetic field immunity test</b>	30 A/m 38 $\mu\text{T}$	IEC 61000-4-8

## Mechanics/electronics

### ▶ Connection

<b>Cable</b>	2 m, 4-wire 4 x 0.14 mm <sup>2</sup> , Ø = 3.3 mm, PVC, Black
<b>Plug</b>	M8, 4-pin, male

### ▶ Wiring

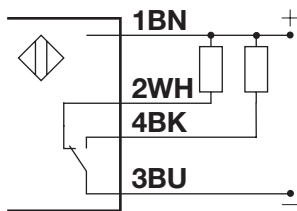

Fig. 4 NPN

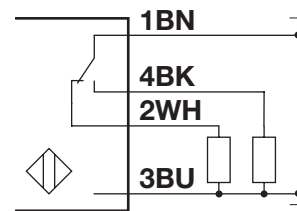

Fig. 5 PNP

BN	WH	BK	BU
Brown	White	Black	Blue

### ▶ Housing

<b>Body</b>	Stainless steel, AISI316L	
<b>Front glass</b>	PPSU, Red	
<b>Trimmer shaft</b>	PEEK, Light grey	
<b>Indication</b>	PES, Transparent	Polyethersulfone
<b>Sealing</b>	FKM	Fluoroelastomer
<b>Cable gland</b>	FKM	Fluoroelastomer
<b>Dimensions</b>	11 x 31.5 x 21 mm	
<b>Weight</b>	≤ 100 g	Cable version
	≤ 65 g	Plug version

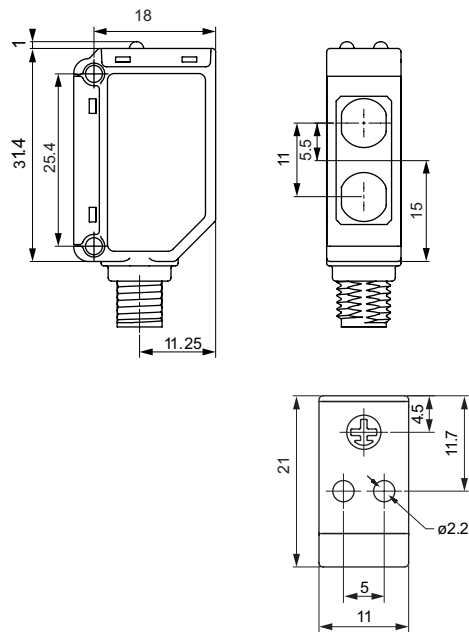
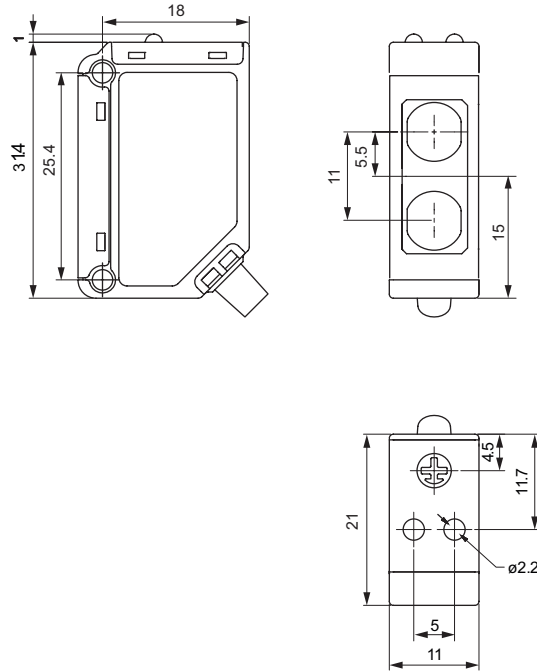

Dimensions





## Compatibility and conformity

### ▶ Approvals and markings

<b>General reference</b>	Sensor designed according to EN60947-5-2	
<b>MTTF<sub>d</sub></b>	176.5 years @ 40°C (+104°F)	ISO 13849-1, SN 29500
<b>CE-marking</b>		
<b>Approvals</b>	 (UL508 + C22.2)	
<b>Other Approvals</b>		Topax 56, Topaz AC1, Topaz MD3, Topaz CL1, Topactiv OKTO, P3-hypochloran



## References

**Product selection key**

PD30ETD02  A  WE

Enter the code option instead of

Code	Option	Description
P	-	Photoelectric sensor
D	-	Rectangular housing
30	-	Length of housing
E	-	Stainless steel
T	-	Top trimmer
D	-	Diffuse reflective
02	-	Distance [dm]
<input type="checkbox"/>	N	NPN
	P	PNP
A	-	Output: N.O. and N.C.
<input type="checkbox"/>	-	Cable, 2 m
	M5	Connector M8
WE	-	Extreme wide angle

**Type selection**

Conne- ction	Output	Code
Cable	NPN	PD30ETD02NAWE
	PNP	PD30ETD02PAWE
Plug	NPN	PD30ETD02NAM5WE
	PNP	PD30ETD02PAM5WE



# Delivery contents and accessories



## ▶ Delivery contents

- Photoelectric switch: PD30ETD02...
- Screwdriver
- Packaging: Carton box
- Mounting bracket: APD30-MB1

## ▶ Accessories

- Mounting bracket: APD30-MB2 to be purchased separately
- Connector type: CO..54NF... series to be purchased separately

## ▶ Further information

Information	Where to find it	QR
Mounting brackets	<a href="http://cga.pub/?6fa29a">http://cga.pub/?6fa29a</a>	
Connectors	<a href="http://cga.pub/?0aae3e">http://cga.pub/?0aae3e</a>	



COPYRIGHT ©2020  
 Content subject to change. Download the PDF: [www.gavazziautomation.com](http://www.gavazziautomation.com)

## X-ON Electronics

Largest Supplier of Electrical and Electronic Components

*Click to view similar products for [Photoelectric Sensors](#) category:*

*Click to view products by [Carlo Gavazzi](#) manufacturer:*

Other Similar products are found below :

[7442AD2X5FRX](#) [EX-19B-LP](#) [7443AR0X5FRX](#) [7452AD4D4NNX](#) [F3WD052C5M](#) [7655AR-04-F-1-2-RX](#) [7694ADE04DS2X](#) [FE7C-FRC6S-M](#) [PM-R24-R](#) [Q45VR2FPQ](#) [E3JUXM4MN](#) [E3S3LE21](#) [E3SCT11M1J03M](#) [E3VDS70C43S](#) [E3XNM16](#) [BR23P](#) [HOA6563-001](#) [OJ-3307-30N8](#) [OS-311A-30](#) [P34036](#) [P60001](#) [PB10CNT15PO](#) [S14132](#) [S52101](#) [S56258](#) [SH-21E](#) [SH-32R](#) [FD-SN500](#) [SU-79](#) [T36342](#) [T40300](#) [T60001](#) [PD60CNX20BP](#) [FX-302-HY](#) [PX-22](#) [PZ2-51P](#) [CYNUTX10](#) [UZB802](#) [UZB803](#) [UZFRG1](#) [UZFRG4](#) [UZFRT4](#) [UZFTT8](#) [ZX-XC4A4M](#) [E3D-R3Y1](#) [E3E23Y2US](#) [E3E-R1Y2](#) [E3SDS20E1](#) [E3TFD14N](#) [E3XR-CC4](#)