

# Limit Switches - Safety Type Plastic Body IP65 and Metal Body IP66



- High mechanical resistant
- Double Insulation □ (for thermoplastic type)
- Degree of protection IP65 (thermoplastic) IP66 (metal)
- Reinforced UL-V0 thermoplastic fiber-glass body
- Zinc alloy (Zamack) or aluminium body
- Positive Opening Operation ☺
- Minimum Actuation Force/Torque
- Minimum Force to achieve Positive Opening Operation
- Precise operating points (consistency)
- Immune to electromagnetic disturbances
- Zb type contact blocks
- Current Ith = 10A
- Rated insulation voltage Ui = 500V
- UL, CSA, CE
- Conform with IEC 947-5-1 (EN 60947-5-1)

## Product Description

They are developed in order to be used for following operations:  
For monitoring and protection of industrial machines, without inertia, in which down-time is less than access time to the dangerous area.  
Use on sliding or pivoting protectors (covers, cases, doors, grids, etc.).  
To protect operators working on dangerous machines, by opening the control circuit. Withdrawal of key by opening the mobile protector, causes immediate

stopping of the machine drive. Specific limit switches ideal for monitoring and protection of light industrial machines without inertia, equipped with angular movement protectors (doors, hinges, rotative covers, grid, etc.).  
Detection by the rotative axis or by means of a lever. Opening of the mobile protector guarantees operator protection by immediately stopping the machine drive.  
To control the access point of the hazardous area.

## Ordering Key

**PS21S-PS1105-T00**

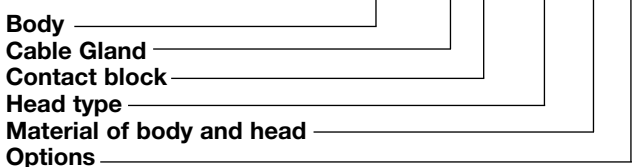

## Description of the key codes

for Key actuator (key must be ordered separately) Hinge and Wire					
PS21S	P	S11	05	T	00
PS42S	N	S02	09	Y	
PS21H	B	T11	HZ		
PS42H	A	O11	HS		
	M	T02	HC		
PS21R			N6		
PS42R			N7		K0 <sup>4</sup>

for Key actuator (key must be ordered separately) and Wire					
PS31S	P	S11	05	Y	00
PS43S	N	S02		T <sup>5</sup>	
	M	T11			
PS31R		O11	N7		
PS43R		T02	N7		K0 <sup>4</sup>
		T21			
		T12			
		T03			

### Cable Gland

<b>M</b>	M20
<b>P</b>	PG13.5
<b>B</b>	PG11
<b>A</b>	M16
<b>N</b>	1/2 NPT

### Contact block

<b>O11</b>	1NO+1NC overlap slow(+)
<b>S02</b>	2NC snap(+)
<b>S11</b>	1NO+1NC snap(+)
<b>T02</b>	2NC slow(+)
<b>T03</b>	3NC slow(+)
<b>T11</b>	1NO+1NC slow(+)
<b>T12</b>	1NO+2NC slow(+)
<b>T21</b>	2NO+1NC slow(+)

### Material of body and head

<b>T</b>	Thermoplastic Body and Thermoplastic head
<b>Y</b>	Metal Body and Thermoplastic head

### Body

<b>PS21H</b>	PS 30mm/1.18" (fix 20/22mm/0.79"/0.87") 1 cable inlet for hinge (shaft or pin)
<b>PS42H</b>	PS 50mm/1.97" (fix 40/42mm/1.57"/1.65") 2 cable inlet for hinge (shaft or pin)
<b>PS21R</b>	PS 30mm/1.18" (fix 20/22mm/0.79"/0.87") 1 cable inlet for pull wire
<b>PS31R</b>	PS 40mm/1.57" (fix 30mm/1.18") 1 cable inlet for pull wire
<b>PS42R</b>	PS 50mm/1.97" (fix 40/42mm/1.57"/1.65") 2 cable inlet for pull wire
<b>PS43R</b>	PS 60mm/2.36" (fix 40/42mm/1.57"/1.65") 3 cable inlet for pull wire
<b>PS21S</b>	PS 30mm/1.18" (fix 20/22mm/0.79"/0.87") 1 cable inlet for Key actuator
<b>PS31S</b>	PS 40mm/1.57" (fix 30mm/1.18") 1 cable inlet for Key actuator
<b>PS42S</b>	PS 50mm/1.97" (fix 40/42mm/1.57"/1.65") 2 cable inlet for Key actuator
<b>PS43S</b>	PS 60mm/2.36" (fix 40/42mm/1.57"/1.65") 3 cable inlet for Key actuator

### Head type

<b>05</b>	90° Adj. key head
<b>09</b>	Fully turnable key head
<b>HC</b>	Zinc plated steel LEVER
<b>HS</b>	Stainless steel shaft
<b>HZ</b>	Zinc plated steel shaft
<b>N6</b>	Pull wire for simple stop
<b>N7</b>	Pull wire for emergency stop

### Options

<b>00</b>	no option
<b>K0</b>	with reset button

## Technical Data

	<b>Plastic Body</b>	<b>Metal body</b>
<b>Standards</b>	IEC 60947-1, IEC 60947-5-1, EN 60947-1, EN 60947-5-1, UL508 and CSA C22-2 n°14	
<b>Certifications – Approvals</b>	UL – CSA	
<b>Air temperature</b> near the device - during operation - for storage	-25°C...+70°C/-13°F...158°F -30°C...+80°C/-22°F...+176°F	
<b>Climatic withstand</b>	According to IEC 68-2-3 and salty mist according to IEC 68-2-11	
<b>Mounting positions</b>	All positions are authorized	
<b>Shock withstand</b> (according to IEC 68-2-27 and 60068-2-27) (1/2 sinusoidal shock for 11ms) no change in contact position	10g/0.35oz Limit switch with <b>key actuator</b> 40g/1.41oz Limit switch for <b>hinge (pin/shaft) or pull wire (rope)</b>	
<b>Protection against electrical shocks</b> (according to IEC 536)	<b>Class II</b>	<b>Class I</b>
<b>Degree of protection</b> (according to IEC 529 and EN 60529)	<b>IP65</b>	<b>IP66</b>

## Electrical Data

	<b>Plastic Body</b>	<b>Metal body</b>
<b>Rated insulation voltage <math>U_i</math></b> -according to IEC 60947-1 and EN 60947-1	<b>500V</b> (degree of pollution 3)	<b>400V</b> (PS21,PS42), <b>500V</b> (PS31,PS43) (degree of pollution 3)
-according to UL 508, CSA C22-2 n°14	<b>A 600 Q600</b>	<b>A 300 Q 300</b> (PS21, PS42) <b>A 600 Q 600</b> (PS31, PS43)
<b>Rated impulse withstand voltage <math>U_{imp}</math></b> (according to IEC 60947-1 and EN 60947-1)	<b>6kV</b>	
<b>Conventional enclosed thermal current <math>I_{the}</math></b> (according to IEC 60947-1 and EN 60947-5-1) ( $\theta \leq 40^\circ\text{C}$ )	<b>10A</b>	
<b>Short-circuit protection - gG type fuses</b>	<b>10A</b>	
<b>Rated operational current</b>		
<b><math>I_e</math> / AC-15</b> - acc.to IEC 60947-5-1	24VAC (50/60 Hz) 130VAC (50/60 Hz) 230VAC (50/60 Hz) 240VAC (50/60 Hz) 400VAC (50/60 Hz)	<b>10.0A</b> <b>5.5A</b> <b>3.1A</b> <b>3.0A</b> <b>1.8A</b>
- acc.to UL 508, CSA C22 n°14	<b>Q 600</b>	<b>Q 300</b> (PS21/42) <b>Q 600</b> (PS31/43)
<b><math>I_e</math> / DC-13</b> - acc.to IEC 60947-5-1	24VDC 110VDC 250VDC	<b>2.8A</b> <b>0.6A</b> <b>0.27A</b>
- acc.to UL 508, CSA C22 n°14	<b>Q 600</b>	<b>Q 300</b> (PS21/42) <b>Q 600</b> (PS31/43)
<b>Electrical durability</b> (according to IEC 60497-5-1 annex C) - max. switching frequency Cycles/h - load factor	Utilization categories AC-15 and DC-13 (see curves and value below) <b>3600</b> <b>0.5</b>	
<b>Connecting data of contact blocks</b> Connecting terminals Connecting capacity 1 or 2 x mm <sup>2</sup> / AWG Terminal marking	<b>M3.5 (+,-) pozidriv 2 screw with cable clamp</b> <b>0.5mm<sup>2</sup> / AWG 20 to 2.5mm<sup>2</sup> / AWG 14</b> <b>According to EN 50013</b>	
<b>Positivity</b>	Contacts with positive opening operation as per IEC 60947-5-1 chapter 3	

**Diagram for snap action contact:**

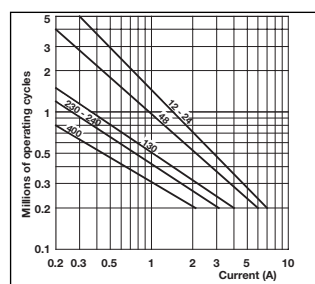

**Diagram for slow action contact:**

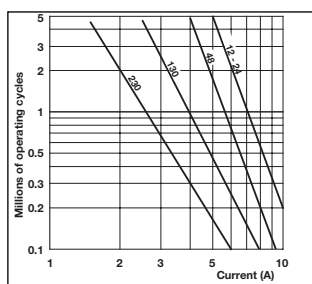

**Electrical durability for DC-13 utilization category**

Power breaking for a durability of 5 million operating cycles		
	Snap action	Slow action
Voltage 24V	9.5W	12W
Voltage 48V	6.8W	9W
Voltage 110V	3.6W	6W

# Limit Switches - Limit Type (PS21S/H/R) Plastic Body IP65



## ● Cable Gland

- P = one cable inlet PG13.5 cable gland
- M = one cable inlet M20x1.5 cable gland
- N = one cable inlet 1/2" NPT cable gland
- B = one cable inlet PG11 cable gland
- A = one cable inlet M16x1.5 cable gland

## ▲ Contact block (Zb type)

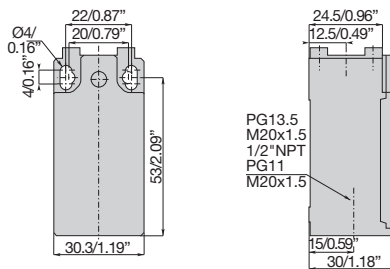

<b>S11</b> (1NO+1NC) Snap Action		<b>T11</b> (1NO+1NC) Non overlapping Slow action		<b>O11</b> (1NO+1NC) Overlapping Slow Action	
<b>T02</b> (2NC) Slow Action		<b>S02</b> (2NC) Snap Action			

		<b>S11</b>	<b>T11</b>	<b>O11</b>
		<b>T02</b>	<b>S02</b>	

<b>Conformity</b> / (NC)	EN 50047 / (NC)	<b>90° adjustable head</b>	
<b>Max. Actuation speed</b>	0.5m/s / 1.64ft/s	<b>Code</b>	PS21S-●▲05-T00
<b>Min. force or torque</b>	15N / 30Nm		
<b>Weight</b>	78.0g / 2.751oz		

		<b>S11</b>	<b>T11</b>	<b>O11</b>
		<b>T02</b>	<b>S02</b>	

<b>Conformity</b> / (NC)	EN 50047 / (NC)	<b>Fully turnable head</b>	
<b>Max. Actuation speed</b>	0.5m/s / 1.64ft/s	<b>Code</b>	PS21S-●▲09-T00
<b>Min. force or torque</b>	15N / 30Nm		
<b>Weight</b>	99.0g / 3.492oz		

		<b>S11</b>	<b>T11</b>	<b>O11</b>
		<b>T02</b>	<b>S02</b>	

<b>Conformity</b> / (NC)	EN 50047 / (NC)	<b>Shaft for hinge</b>	
<b>Max. Actuation speed</b>	0.5m/s / 1.64ft/s	<b>Code</b> Zinc plated steel	PS21H-●▲HZ-T00
<b>Min. force or torque</b>	0.12N / 0.60Nm	Stainless steel	PS21H-●▲HS-T00
<b>Weight</b>	98.0g / 3.457oz		

		<b>S11</b>	<b>T11</b>	<b>O11</b>
		<b>T02</b>	<b>S02</b>	

<b>Conformity</b> / (NC)	EN 50047 / (NC)	<b>Zinc plated steel lever</b>	
<b>Max. Actuation speed</b>	0.5m/s / 1.64ft/s	<b>Code</b>	PS21H-●▲HC-T00
<b>Min. force or torque</b>	0.12N / 0.60Nm		
<b>Weight</b>	117.0g / 4.127oz		

			<b>S11</b>	<b>T11</b>	<b>O11</b>
			<b>T02</b>	<b>S02</b>	

<b>Conformity / (NC)</b>	- / (NC)	<b>Pull wire without reset for simple stop</b>	
<b>Max. Actuation speed</b>	-	<b>Code</b>	<b>PS21R-  N6-T00</b>
<b>Max wire length</b>	6m/19.68ft ÷ 15m/49.21ft		
<b>Weight</b>	130.0g / 4.586oz		

			<b>S11</b>	<b>T11</b>	<b>O11</b>
			<b>T02</b>	<b>S02</b>	

<b>Conformity / (NC)</b>	EN 50047 / (NC)	<b>Pull wire with reset for emergency stop</b>	
<b>Max. Actuation speed</b>	-	<b>Code</b>	<b>PS21R-  N7-TK0</b>
<b>Max wire length</b>	6m/19.68ft ÷ 15m/49.21ft		
<b>Weight</b>	135.0g / 4.762oz		

## Operating Key

<b>K13</b> Bent Key 22mm/0.87"	<b>K14</b> Flat Key 22mm/0.87"	<b>K15</b> Bent Key 13mm/0.51"	<b>K16</b> Flat Key 13mm/0.51"	<b>K17</b> Shock absorbing bent key	<b>K18</b> Shock absorbing flat key	<b>K19</b> Adjustable joint key

## Accessories for Pull Wire Limit Switches

<b>OCC 8</b> Stay Bolt	<b>MOR 05</b> Rope Clamp	<b>RED 05</b> Rope Eye	<b>FUN 05</b> Rope 5mm x 100m 0.20" x 328.08ft

# Limit Switches - Safety Type (PS42S/H/R) Plastic Body IP65



## ● Cable Gland

- P = one cable inlet PG13.5 cable gland
- M = one cable inlet M20x1.5 cable gland
- N = one cable inlet 1/2" NPT cable gland
- B = one cable inlet PG11 cable gland
- A = one cable inlet M16x1.5 cable gland

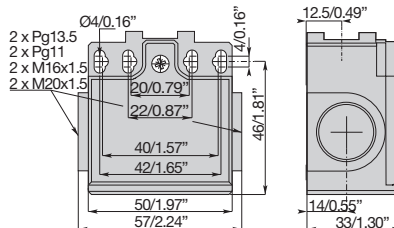

## ▲ Contact block (Zb type)

<b>S11</b> (1NO+1NC) Snap Action		<b>T11</b> (1NO+1NC) Non overlapping Slow action		<b>O11</b> (1NO+1NC) Overlapping Slow Action	
<b>T02</b> (2NC) Slow Action		<b>S02</b> (2NC) Snap Action			

		<b>S11</b>	<b>T11</b>	<b>O11</b>
		<b>T02</b>	<b>S02</b>	

<b>Conformity</b> / (NC)	EN 50047 / (C)	<b>90° adjustable head</b>	
<b>Max. Actuation speed</b>	0.5m/s / 1.64ft/s	<b>Code</b>	PS42S-●▲05-T00
<b>Min. force or torque</b>	15N / 30Nm		
<b>Weight</b>	114.0g / 4.021oz		

		<b>S11</b>	<b>T11</b>	<b>O11</b>
		<b>T02</b>	<b>S02</b>	

<b>Conformity</b> / (NC)	EN 50047 / (C)	<b>Fully turnable head</b>	
<b>Max. Actuation speed</b>	0.5m/s / 1.64ft/s	<b>Code</b>	PS42S-●▲09-T00
<b>Min. force or torque</b>	15N / 30Nm		
<b>Weight</b>	125.0g / 4.409oz		

		<b>S11</b>	<b>T11</b>	<b>O11</b>
		<b>T02</b>	<b>S02</b>	

<b>Conformity</b> / (NC)	EN 50047 / (C)	<b>Shaft for hinge</b>	
<b>Max. Actuation speed</b>	0.5m/s / 1.64ft/s	<b>Code</b>	Zinc plated steel Stainless steel
<b>Min. force or torque</b>	0.12N / 0.60Nm		PS42H-●▲HZ-T00 PS42H-●▲HS-T00
<b>Weight</b>	128.0g / 4.515oz		

		<b>S11</b>	<b>T11</b>	<b>O11</b>
		<b>T02</b>	<b>S02</b>	

<b>Conformity</b> / (NC)	EN 50047 / (C)	<b>Zinc plated steel lever</b>	
<b>Max. Actuation speed</b>	0.5m/s / 1.64ft/s	<b>Code</b>	PS42H-●▲HC-T00
<b>Min. force or torque</b>	0.12N / 0.60Nm		
<b>Weight</b>	152.0g / 5.362oz		

			<b>S11</b> 	<b>T11</b> 	<b>O11</b> 
			<b>T02</b> 	<b>S02</b> 	

<b>Conformity / (NC)</b>	- /	<b>Pull wire without reset for simple stop</b>	
<b>Max. Actuation speed</b>	-	<b>Code</b>	<b>PS42R-  N6-T00</b>
<b>Max wire length</b>	6m/19.68ft ÷ 15m/49.21ft		
<b>Weight</b>	158.0g / 5.573oz		

			<b>S11</b> 	<b>T11</b> 	<b>O11</b> 
			<b>T02</b> 	<b>S02</b> 	

<b>Conformity / (NC)</b>	EN 50047 /	<b>Pull wire with reset for emergency stop</b>	
<b>Max. Actuation speed</b>	-	<b>Code</b>	<b>PS42R-  N7-TK0</b>
<b>Max wire length</b>	6m/19.68ft ÷ 15m/49.21ft		
<b>Weight</b>	163.0g / 5.750oz		

## Operating Key

<b>K13</b> Bent Key 22mm/0.87"	<b>K14</b> Flat Key 22mm/0.87"	<b>K15</b> Bent Key 13mm/0.51"	<b>K16</b> Flat Key 13mm/0.51"	<b>K17</b> Shock absorbing bent key	<b>K18</b> Shock absorbing flat key	<b>K19</b> Adjustable joint key

## Accessories for Pull Wire Limit Switches

<b>OCC 8</b> Stay bolt	<b>MOR 05</b> Rope Clamp	<b>RED 05</b> Rope Eye	<b>FUN 05</b> Rope 5mm x 100m 0.20" x 328.08ft

# Limit Switches - Safety Type (PS31S) plastic Body IP65



## ● Cable Gland

- P = one cable inlet PG13.5 cable gland
- M = one cable inlet M20x1.5 cable gland
- N = one cable inlet 1/2" NPT cable gland

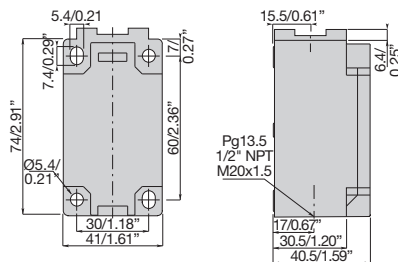

## ▲ Contact block (Zb type)

<b>S11</b> (1NO+1NC) Snap action		<b>T11</b> (1NO+1NC) Non overlapping Slow action		<b>O11</b> (1NO+1NC) Overlapping Slow action		<b>T02</b> (2NC) Slow Action	
<b>S02</b> (2NC) Snap action		<b>T12</b> (1NO+2NC) Non overlapping Slow action		<b>T21</b> (2NO+1NC) Non overlapping Slow action		<b>T03</b> (3NC) Simultaneous Slow action	

		<b>S11</b>	<b>T11</b>	<b>O11</b>	<b>T02</b>
		<b>S02</b>	<b>T12</b>	<b>T21</b>	<b>T03</b>

<b>Conformity</b> (↗) (NC)	EN 50041 (↗)	<b>Key operated</b> 90° adjustable head	
<b>Max. Actuation speed</b>	0.5m/s / 1.64ft/s	<b>Code</b>	PS31S-●▲05-T00
<b>Min. force or torque</b>	30N / 45Nm		
<b>Weight</b>	158.0g / 5.573oz		

## Operating Key

<b>K35</b> Bent Key 13mm/0.51"	<b>K36</b> Flat Key 13mm/0.51"	<b>K39</b> Adjustable Joint Key





# Limit Switches - Safety Type (PS21S/H/R) Metal Body IP66



## ● Cable Gland

- P** = one cable inlet PG13.5 cable gland
- M** = one cable inlet M20x1.5 cable gland
- N** = one cable inlet 1/2" NPT cable gland
- B** = one cable inlet PG11 cable gland
- A** = one cable inlet M16x1.5 cable gland

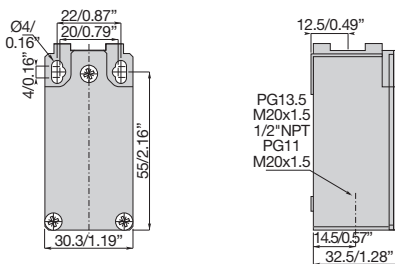

## ▲ Contact block (Zb type)

<b>S11</b> (1NO+1NC) Snap Action		<b>T11</b> (1NO+1NC) Non overlapping Slow action		<b>O11</b> (1NO+1NC) Overlapping Slow Action	
<b>T02</b> (2NC) Slow Action		<b>S02</b> (2NC) Snap Action			

		<b>S11</b>	<b>T11</b>	<b>O11</b>
		<b>T02</b>	<b>S02</b>	

<b>Conformity</b> / (NC)	EN 50047 / (NC)	<b>90° adjustable head</b>	
<b>Max. Actuation speed</b>	0.5m/s / 1.64ft/s	<b>Code</b>	PS21S-●▲05-Y00
<b>Min. force or torque</b>	15N / 30Nm		
<b>Weight</b>	177.0g / 6.243oz		

		<b>S11</b>	<b>T11</b>	<b>O11</b>
		<b>T02</b>	<b>S02</b>	

<b>Conformity</b> / (NC)	EN 50047 / (NC)	<b>Fully turnable head</b>	
<b>Max. Actuation speed</b>	0.5m/s / 1.64ft/s	<b>Code</b>	PS21S-●▲09-Y00
<b>Min. force or torque</b>	15N / 30Nm		
<b>Weight</b>	195.0g / 6.878oz		

		<b>S11</b>	<b>T11</b>	<b>O11</b>
		<b>T02</b>	<b>S02</b>	

<b>Conformity</b> / (NC)	EN 50047 / (NC)	<b>Shaft for hinge</b>	
<b>Max. Actuation speed</b>	0.5m/s / 1.64ft/s	<b>Code</b>	Zinc plated steel Stainless steel
<b>Min. force or torque</b>	0.12N / 0.60Nm		PS21H-●▲HZ-Y00 PS21H-●▲HS-Y00
<b>Weight</b>	195.0g / 6.878oz		

		<b>S11</b>	<b>T11</b>	<b>O11</b>
		<b>T02</b>	<b>S02</b>	

<b>Conformity</b> / (NC)	EN 50047 / (NC)	<b>Zinc plated steel lever</b>	
<b>Max. Actuation speed</b>	0.5m/s / 1.64ft/s	<b>Code</b>	PS21H-●▲HC-Y00
<b>Min. force or torque</b>	0.12N / 0.60Nm		
<b>Weight</b>	213.0g / 7.513oz		

			<b>S11</b> 	<b>T11</b> 	<b>O11</b> 
			<b>T02</b> 	<b>S02</b> 	

<b>Conformity / (NC)</b>	- /	<b>Pull wire without reset for simple stop</b>	
<b>Max. Actuation speed</b>	-	<b>Code</b>	<b>PS21R-  N6-Y00</b>
<b>Max wire length</b>	6m/19.68ft ÷ 15m/49.21ft		
<b>Weight</b>	226.0g / 7.972oz		

			<b>S11</b> 	<b>T11</b> 	<b>O11</b> 
			<b>T02</b> 	<b>S02</b> 	

<b>Conformity / (NC)</b>	EN 50047 /	<b>Pull wire with reset for emergency stop</b>	
<b>Max. Actuation speed</b>	-	<b>Code</b>	<b>PS21R-  N7-YK0</b>
<b>Max wire length</b>	6m/19.68ft ÷ 15m/49.21ft		
<b>Weight</b>	231.0g / 8.148oz		

## Operating Key

<b>K13</b> Bent Key 22mm/0.87"	<b>K14</b> Flat Key 22mm/0.87"	<b>K15</b> Bent Key 13mm/0.51"	<b>K16</b> Flat Key 13mm/0.51"	<b>K17</b> Shock absorbing bent key	<b>K18</b> Shock absorbing flat key	<b>K19</b> Adjustable joint key

## Accessories for Pull Wire Limit Switches

<b>OCC 8</b> Stay bolt	<b>MOR 05</b> Rope Clamp	<b>RED 05</b> Rope Eye	<b>FUN 05</b> Rope 5mm x 100m 0.20" x 328.08ft

# Limit Switches - Safety Type (PS42S/H/R) Metal Body IP66



## ● Cable Gland

- P = one cable inlet PG13.5 cable gland
- M = one cable inlet M20x1.5 cable gland
- N = one cable inlet 1/2" NPT cable gland
- B = one cable inlet PG11 cable gland
- A = one cable inlet M16x1.5 cable gland

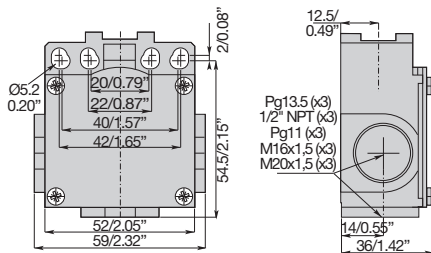

## ▲ Contact block (Zb type)

<b>S11</b> (1NO+1NC) Snap Action		<b>T11</b> (1NO+1NC) Non overlapping Slow action		<b>O11</b> (1NO+1NC) Overlapping Slow Action	
<b>T02</b> (2NC) Slow Action		<b>S02</b> (2NC) Snap Action			

		<b>S11</b>	<b>T11</b>	<b>O11</b>
		<b>T02</b>	<b>S02</b>	

<b>Conformity</b> / (NC)	EN 50047 / (NC)	<b>90° adjustable head</b>	
<b>Max. Actuation speed</b>	0.5m/s / 1.64ft/s	<b>Code</b>	PS42S-●▲05-Y00
<b>Min. force or torque</b>	15N / 30Nm		
<b>Weight</b>	285.0g / 10.053oz		

		<b>S11</b>	<b>T11</b>	<b>O11</b>
		<b>T02</b>	<b>S02</b>	

<b>Conformity</b> / (NC)	EN 50047 / (NC)	<b>Fully turnable head</b>	
<b>Max. Actuation speed</b>	0.5m/s / 1.64ft/s	<b>Code</b>	PS42S-●▲09-Y00
<b>Min. force or torque</b>	15N / 30Nm		
<b>Weight</b>	296.0g / 10.441oz		

		<b>S11</b>	<b>T11</b>	<b>O11</b>
		<b>T02</b>	<b>S02</b>	

<b>Conformity</b> / (NC)	EN 50047 / (NC)	<b>Shaft for hinge</b>	
<b>Max. Actuation speed</b>	0.5m/s / 1.64ft/s	<b>Code</b> Zinc plated steel	PS42H-●▲HZ-Y00
<b>Min. force or torque</b>	0.12N / 0.60Nm	Stainless steel	PS42H-●▲HS-Y00
<b>Weight</b>	297.0g / 10.476oz		

		<b>S11</b>	<b>T11</b>	<b>O11</b>
		<b>T02</b>	<b>S02</b>	

<b>Conformity</b> / (NC)	EN 50047 / (NC)	<b>Zinc plated steel lever</b>	
<b>Max. Actuation speed</b>	0.5m/s / 1.64ft/s	<b>Code</b>	PS42H-●▲HC-Y00
<b>Min. force or torque</b>	0.12N / 0.60Nm		
<b>Weight</b>	297.0g / 10.476oz		

			<b>S11</b>	<b>T11</b>	<b>O11</b>
			<b>T02</b>	<b>S02</b>	

<b>Conformity / (NC)</b>	- / (NC)	<b>Pull wire without reset for simple stop</b>	
<b>Max. Actuation speed</b>	-	<b>Code</b>	<b>PS42R-●▲N6-Y00</b>
<b>Max wire length</b>	6m/19.68ft ÷ 15m/49.21ft		
<b>Weight</b>	292.0g / 10.300oz		

			<b>S11</b>	<b>T11</b>	<b>O11</b>
			<b>T02</b>	<b>S02</b>	

<b>Conformity / (NC)</b>	EN 50047 / (NC)	<b>Pull wire with reset for emergency stop</b>	
<b>Max. Actuation speed</b>	-	<b>Code</b>	<b>PS42R-●▲N7-YK0</b>
<b>Max wire length</b>	6m/19.68ft ÷ 15m/49.21ft		
<b>Weight</b>	297.0g / 10.476oz		

## Operating Key

<b>K13</b> Bent Key 22mm/0.87"	<b>K14</b> Flat Key 22mm/0.87"	<b>K15</b> Bent Key 13mm/0.51"	<b>K16</b> Flat Key 13mm/0.51"	<b>K17</b> Shock absorbing bent key	<b>K18</b> Shock absorbing flat key	<b>K19</b> Adjustable joint key

## Accessories for Pull Wire Limit Switches

<b>OCC 8</b> Stay bolt	<b>MOR 05</b> Rope Clamp	<b>RED 05</b> Rope Eye	<b>FUN 05</b> Rope 5mm x 100m 0.20" x 328.08ft

# Limit Switches - Safety Type (PS31S/R) Metal Body IP66



## ● Cable Gland

- P = one cable inlet PG13.5 cable gland
- M = one cable inlet M20x1.5 cable gland
- N = one cable inlet 1/2" NPT cable gland

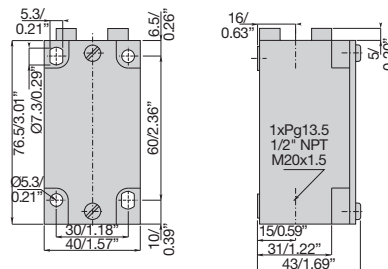

## ▲ Contact block (Zb type)

<b>S11</b> (1NO+1NC) Snap action		<b>T11</b> (1NO+1NC) Non overlapping Slow action		<b>O11</b> (1NO+1NC) Overlapping Slow action		<b>T02</b> (2NC) Slow Action	
<b>S02</b> (2NC) Snap action		<b>T12</b> (1NO+2NC) Non overlapping Slow action		<b>T21</b> (2NO+1NC) Non overlapping Slow action		<b>T03</b> (3NC) Simultaneous Slow action	

		<b>S11</b>	<b>T11</b>	<b>O11</b>	<b>T02</b>
		<b>S02</b>	<b>T12</b>	<b>T21</b>	<b>T03</b>

<b>Conformity</b> / (NC)	EN 50041 / (C)	<b>Key operated 90° adjustable head</b>
<b>Max. Actuation speed</b>	0.5m/s / 1.64ft/s	<b>Code</b>
<b>Min. force or torque</b>	30N / 45Nm	<b>PS31S-●▲05-Y00</b>
<b>Weight</b>	210.0g / 7.408oz	

		<b>S11</b>	<b>T11</b>	<b>O11</b>	<b>T02</b>
		<b>S02</b>	<b>T12</b>	<b>T21</b>	<b>T03</b>

<b>Conformity</b> / (NC)	EN 50041 / (C)	<b>Pull wire without reset for simple stop</b>
<b>Max. Actuation speed</b>	0.5m/s / 1.64ft/s	<b>Code</b>
<b>Min. force or torque</b>	16m/52.49ft ÷ 25m/82.02ft	<b>PS31R-●▲N7-Y00</b>
<b>Weight</b>	268.0g / 9.453oz	

		<b>S11</b>	<b>T11</b>	<b>O11</b>	<b>T02</b>
		<b>S02</b>	<b>T12</b>	<b>T21</b>	<b>T03</b>

<b>Conformity</b> / (NC)	EN 50041 / (C)	<b>Pull wire with reset for emergency stop</b>
<b>Max. Actuation speed</b>	0.5m/s / 1.64ft/s	<b>Code</b>
<b>Min. force or torque</b>	16m/52.49ft ÷ 25m/82.02ft	<b>PS31R-●▲N7-YK0</b>
<b>Weight</b>	270.0g / 9.524oz	

## Operating Key

<b>K35</b> Bent Key 13mm/0.51"		<b>K36</b> Flat Key 13mm/0.51"		<b>K39</b> Adjustable Joint Key	

# Limit Switches - Safety Type (PS43S/R) Metal Body IP66



## ● Cable Gland

- P = one cable inlet PG13.5 cable gland
- M = one cable inlet M20x1.5 cable gland
- N = one cable inlet 1/2" NPT cable gland

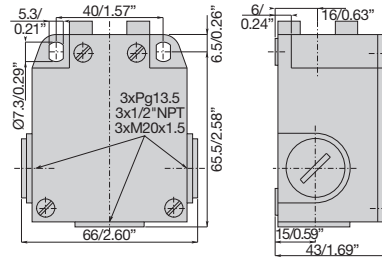

## ▲ Contact block (Zb type)

<b>S11</b> (1NO+1NC) Snap action	<b>T11</b> (1NO+1NC) Non overlapping Slow action	<b>O11</b> (1NO+1NC) Overlapping Slow action	<b>T02</b> (2NC) Slow Action
<b>S02</b> (2NC) Snap action	<b>T12</b> (1NO+2NC) Non overlapping Slow action	<b>T21</b> (2NO+1NC) Non overlapping Slow action	<b>T03</b> (3NC) Simultaneous Slow action

		<b>S11</b>	<b>T11</b>	<b>O11</b>	<b>T02</b>
		<b>S02</b>	<b>T12</b>	<b>T21</b>	<b>T03</b>

<b>Conformity</b> / (NC)	EN 50041 / (NC)	<b>Key operated 90° adjustable head</b>	
<b>Max. Actuation speed</b>	0.5m/s / 1.64ft/s	<b>Code</b>	PS43S-●▲05-Y00
<b>Min. force or torque</b>	14N / 40Nm		
<b>Weight</b>	227.0g / 8.007oz		

		<b>S11</b>	<b>T11</b>	<b>O11</b>	<b>T02</b>
		<b>S02</b>	<b>T12</b>	<b>T21</b>	<b>T03</b>

<b>Conformity</b> / (NC)	EN 50041 / (NC)	<b>Pull wire without reset for simple stop</b>	
<b>Max. Actuation speed</b>	0.5m/s / 1.64ft/s	<b>Code</b>	PS43R-●▲N7-Y00
<b>Min. force or torque</b>	16m/52.49ft ÷ 25m/82.02ft		
<b>Weight</b>	270.0g / 9.524oz		

		<b>S11</b>	<b>T11</b>	<b>O11</b>	<b>T02</b>
		<b>S02</b>	<b>T12</b>	<b>T21</b>	<b>T03</b>

<b>Conformity</b> / (NC)	EN 50041 / (NC)	<b>Pull wire with reset for emergency stop</b>	
<b>Max. Actuation speed</b>	0.5m/s / 1.64ft/s	<b>Code</b>	PS43R-●▲N7-YK0
<b>Min. force or torque</b>	16m/52.49ft ÷ 25m/82.02ft		
<b>Weight</b>	274.0g / 9.665oz		

## Operating Key

**K35**  
Bent Key  
13mm/0.51"

**K36**  
Flat Key  
13mm/0.51"

**K39**  
Adjustable Joint  
Key

## Utilization precautions

### Maximum lenght application of pullwire head



PS21, PS42: 6m/19.70ft max.  
PS31, PS43: 16m/52.49ft max.

PS21, PS42: 15m/49.21ft max.  
PS31, PS43: 25m/82.02ft max.

### Example of applications

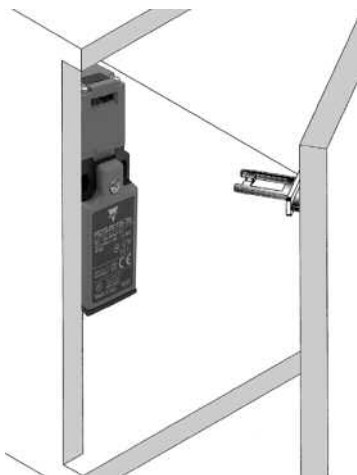

Key actuator type

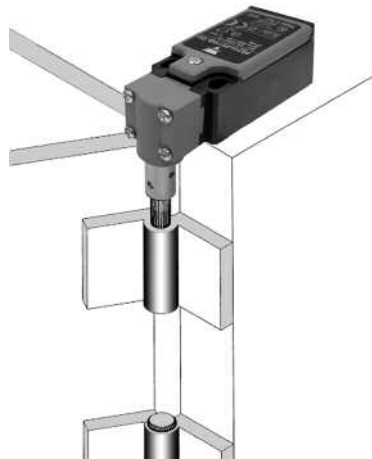

Head for hinge (by pin)







Head for hinge (by shaft)

## Adjustment

### 5 way key actuator head



## Accessories for Pull Wire Limit Switches

			
<b>OCC 8</b> Stay bolt	<b>MOR 05</b> Rope Clamp	<b>RED 05</b> Rope Eye	<b>FUN 05</b> Rope 5mmx100m 0.20" x 328.08ft

## X-ON Electronics

Largest Supplier of Electrical and Electronic Components

*Click to view similar products for [Limit Switches](#) category:*

*Click to view products by [Carlo Gavazzi](#) manufacturer:*

Other Similar products are found below :

[5ML1-E1](#) [5ML31](#) [LZG1](#) [LZL1-6C](#) [622EN114-R](#) [622EN18-6](#) [622EN224-6B](#) [622EN230](#) [622EN237-R](#) [622EN69-3](#) [622EN85-RB](#) [MA-10019](#)  
[6PA109](#) [7LS51](#) [83547001](#) [83725002](#) [83830001](#) [83840701](#) [83841001](#) [83881140](#) [8AS42](#) [8LS10](#) [8LS125-4PG](#) [8LS152-4PGN20](#) [914CE16-](#)  
[3A](#) [914CE3-3L1](#) [915PA10](#) [91MCE16-P2O](#) [924CE16-Y3](#) [924CE1-S6](#) [924CE1-T25A](#) [924CE1-T3](#) [924CE1-T9A](#) [924CE2-T9](#) [924CE31-Y20-](#)  
[X5](#) [924CE31-Y3L1](#) [GL-10054](#) [GLAB26J2B](#) [GLDB03C-6](#) [GLDC05C](#) [PS21R-NT11N7-YK0](#) [RDI-G-L5B](#) [DD-10000](#) [DT-2R3-A7](#) [14CE16-](#)  
[3N28](#) [14CE18-N15](#) [151ML3-E1](#) [E3102BAAAA](#) [BFL1-AW1-S](#) [1EN329-R](#)