

# Limit Switches - Prewired Type Metal Body



- Sealed with epoxy resin at the base of the box
- Degree of protection IP67
- Diecast zinc alloy body
- Positive Opening Operation (→)
- Minimum Actuation Force/Torque
- Minimum Force to achieve Positive Opening Operation
- Precise operating points (consistency)
- Immune to electromagnetic disturbances
- Zb type contact blocks
- Current Ith = 10A
- Rated insulation voltage Ui = 500V
- UL, CSA, CE, RoHS
- Conform with IEC 947-5-1 (EN 60947-5-1)

## Product Description

They are developed with very compact size, to enable its mounting on machine's moving member during adverse environmental conditions and controlling their position.

## Ordering Key

**PS31M-CS11RT-M00**

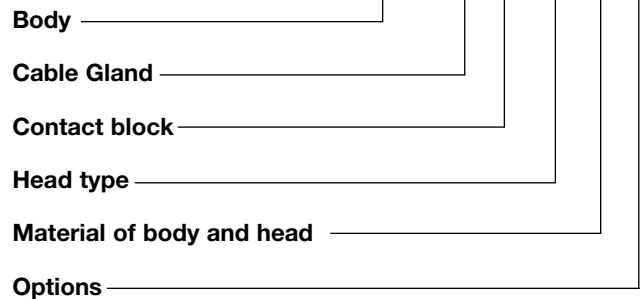

## Description of the key codes

### Body

PS31M | PS 40mm (fix 20mm) 1m cable lateral side (prewired)

### Cable Gland

C | Prewired - std cable  
U | Prewired - UL cable

### Contact block

S11 | 1NO+1NC snap(+)  
T11 | 1NO+1NC slow(+)

### Material of body and head

M | Metal Body and Metal head

### Options

00 | no option  
0L | with fixing nuts (only with head type P0, PR, PY, P9, P8)

### Head type

BE | nylon roller ext bent LEVER  
BO | ball roller bent LEVER  
BR | nylon roller int bent LEVER  
L3 | adj square (3x3) steel rod LEVER  
LA | adj Ø3 rod LEVER stainless steel rod  
LB | nylon actuator with stainless steel spring  
LF | adj fiberglass rod LEVER Ø3  
LG | adj fiberglass rod LEVER Ø6  
LN | adj nylon rod LEVER  
LP | multidir nylon actuator with stainless steel spring  
LS | stainless steel spring multidir actuator  
LW | Stainless steel spring multidir actuator (cat Whisker)  
LZ | Stainless steel spring actuator  
P0 | metal plain PLUNGER  
P8 | nylon cross roller PLUNGER with fixing nuts  
P9 | cross metal roller PLUNGER  
PH | metal PLUNGER +gasket  
PR | metal roller PLUNGER  
PY | nylon roller PLUNGER  
R1 | adj LEVER with nylon roller  
R2 | adj LEVER with stainless steel roller  
RM | metal roller LEVER  
RO | roller LEVER steel ball bearing  
RS | metal roller LEVER  
RT | nylon roller LEVER  
W1 | adj LEVER with Ø50 rubber roller

## Technical Data

### Standards

#### Certifications – Approvals

**Air temperature** near the device

- during operation
- for storage

°C  
°C

Devices conform with international IEC 947-5-1 and European EN 60947-5-1 standards  
UL, CSA, CE, RoHS

-25 ... +70  
-40 ... +70

### Mounting positions

All positions are authorized

**Protection against electrical shocks** (acc.to IEC 536)

**Degree of protection** (according to IEC 529 and EN 60 529)

**Degree of protection** (according to UL50)

corrosion resistant")

**Class I**

**IP67**

**Type 4 - 4X - 6** enclosure ("outdoor use - raintight - watertight

## Electrical Data

### Rated insulation voltage $U_i$

-according to IEC 947-1 and EN 60-947-1

-according to UL 508, CSA C22-2 n°14

### Rated impulse withstand voltage $U_{imp}$

kV

(according to IEC 60947-1 and EN 60947-1)

### Conventional enclosed thermal current $I_{th}$

A

(according to IEC 60947-1 and EN 60947-5-1) ( $\theta \leq 40^\circ\text{C}$ )

### Short-circuit protection - gG type fuses

A

**400V** (degree of pollution 3)

**B 300, R 300**

**4**

**5**

**6**

### Rated operational current

$I_e$  / **AC-15** - acc.to IEC 60947-5-1

24Vac (50/60 Hz) A

120Vac (50/60 Hz) A

240Vac (50/60 Hz) A

**5.0**

**3.0**

**1.5**

$I_e$  / **DC-13** - acc.to IEC 60947-5-1

24Vdc A

110Vdc A

250Vdc A

**1.1**

**0.22**

**0.1**

### Electrical durability

(according to IEC 60497-5-1 annex C)

- max. switching frequency Cycles/h

- load factor

### Mechanical durability

Utilization categories AC-15 and DC-13 (see curves and value below)

**3600**

**0.5**

**10 millions of operations**

Diagram for snap action contact

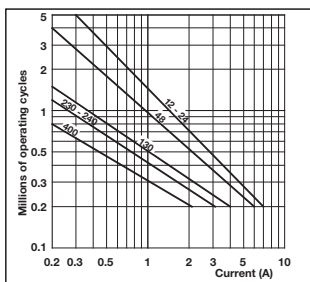
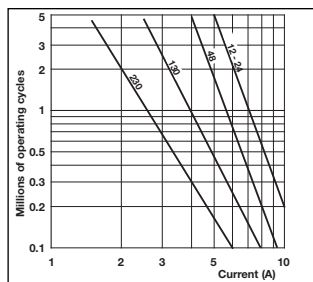

Diagram for slow action contact



Electrical durability for DC-13 utilization category

Power breaking for a durability of 5 million operating cycles		
	Snap action	Slow action
Voltage 24V	9,5W	12W
Voltage 48V	6,8W	9W
Voltage 110V	3,6W	6W

# Limit Switches - Miniature Type (PS31M) Metal Body IP67



## ▣ Cable Characteristics

**C** = Pre-wired, 1m standard cable 4x0.75mm<sup>2</sup>  
**U** = Pre-wired, 1m UL cable 4x0.75mm<sup>2</sup>

(Different lengths available on request)

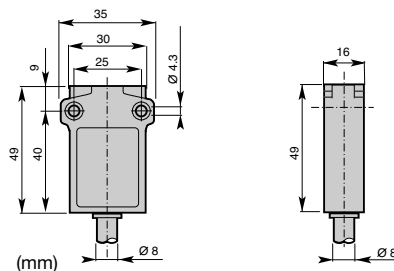

## ▲ Contact block (Zb type)

<b>S11</b> (1NO+1NC) Snap Action		<b>T11</b> (1NO+1NC) Non overlapping Slow action	
-------------------------------------	--	--	--

		<b>S11</b>	<b>T11</b>

<b>Conformity</b> / (NC)	/ (NC)
<b>Max. Actuation speed</b>	0.5ms
<b>Min. force or torque</b>	15N / 30Nm
<b>Weight</b>	180g

**Plain Plunger**  
**Code** PS31M-▣▲P0-M00

		<b>S11</b>	<b>T11</b>

<b>Conformity</b> / (NC)	/ (NC)
<b>Max. Actuation speed</b>	0.1ms
<b>Min. force or torque</b>	10N / 30Nm
<b>Weight</b>	185g

**Roller Plunger**  
**Code** Metal roller PS31M-▣▲PR-M00  
 Nylon roller PS31M-▣▲PY-M00

		<b>S11</b>	<b>T11</b>

<b>Conformity</b> / (NC)	/ (NC)
<b>Max. Actuation speed</b>	0.1ms
<b>Min. force or torque</b>	10N / 30Nm
<b>Weight</b>	185g

**Cross roller plunger**  
**Code** Metal roller PS31M-▣▲P9-M00  
 Nylon roller PS31M-▣▲P8-M00

		<b>S11</b>	<b>T11</b>

<b>Conformity</b> / (NC)	/ (NC)
<b>Max. Actuation speed</b>	0.5ms
<b>Min. force or torque</b>	15N / 30Nm
<b>Weight</b>	185g

**Plain plunger with dust protection cup**  
**Code** PS31M-▣▲PH-M00

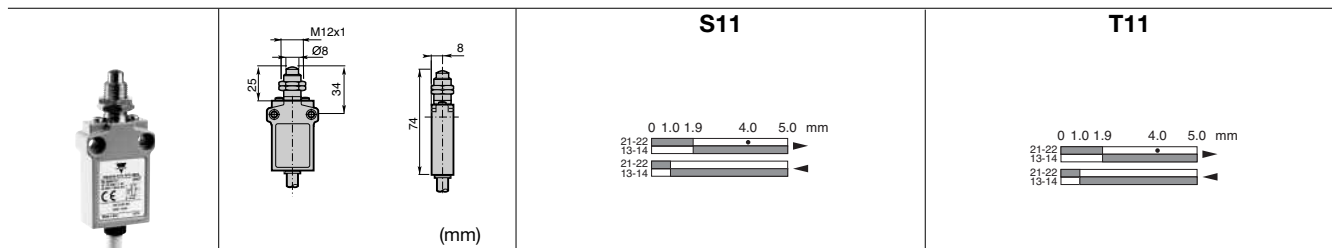

Conformity / (NC) / (NC)  
 Max. Actuation speed 0.5ms  
 Min. force or torque 15N / 30Nm  
 Weight 195g

**S11**  
 Pain plunger with fixing nuts  
 Code

**T11**  
 PS31M-   P0-M0L

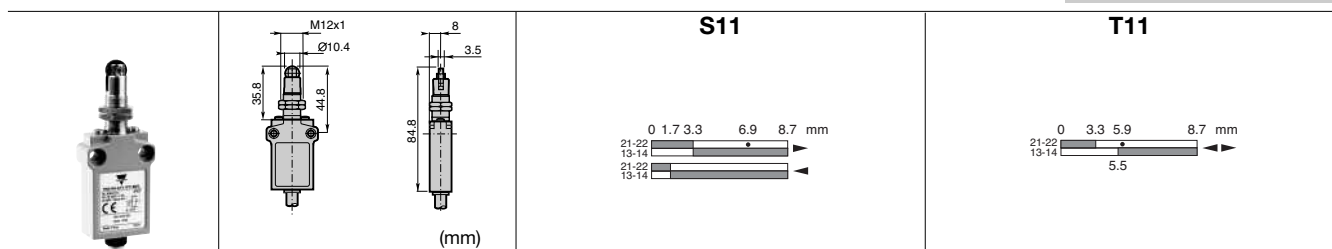

Conformity / (NC) / (NC)  
 Max. Actuation speed 0.1ms  
 Min. force or torque 10N / 30Nm  
 Weight 200g

**S11**  
 Roller plunger with fixing nuts  
 Code metal roller  
 nylon roller

**T11**  
 PS31M-   PR-M0L  
 PS31M-   PY-M0L

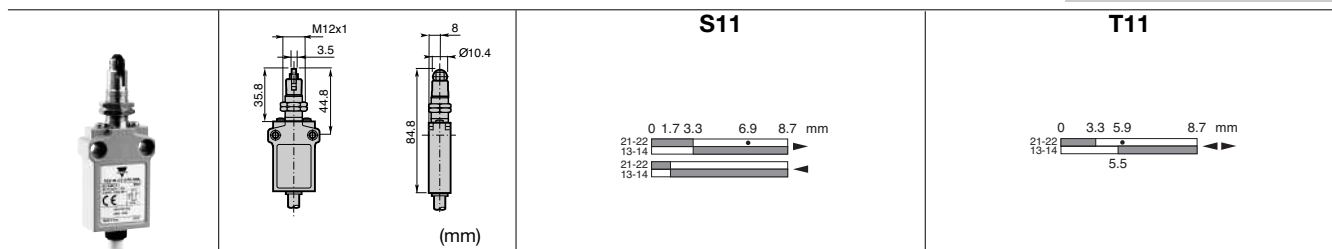

Conformity / (NC) / (NC)  
 Max. Actuation speed 0.1ms  
 Min. force or torque 10N / 30Nm  
 Weight 200g

**S11**  
 Cross roller plunger with fixing nuts  
 Code metal roller  
 nylon roller

**T11**  
 PS31M-   P9-M0L  
 PS31M-   P8-M0L

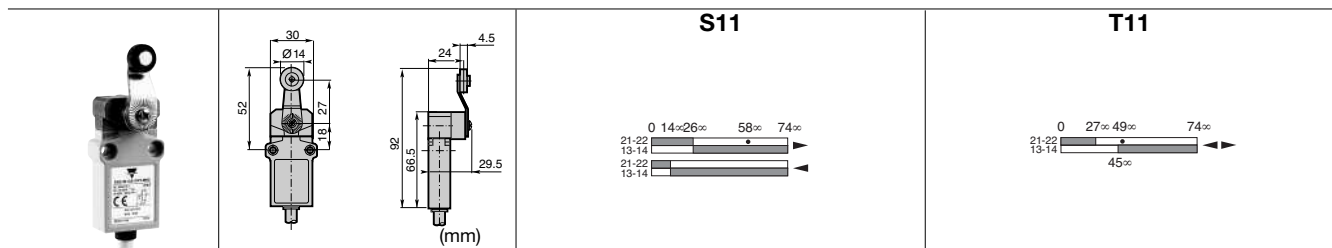

Conformity / (NC) / (NC)  
 Max. Actuation speed 1.5ms  
 Min. force or torque 0.08N / 0.28Nm  
 Weight 230g

**S11**  
 Ø14 roller lever  
 Code nylon roller  
 metal roller  
 ball bearing

**T11**  
 PS31M-   RT-M00  
 PS31M-   RS-M00  
 PS31M-   RO-M00

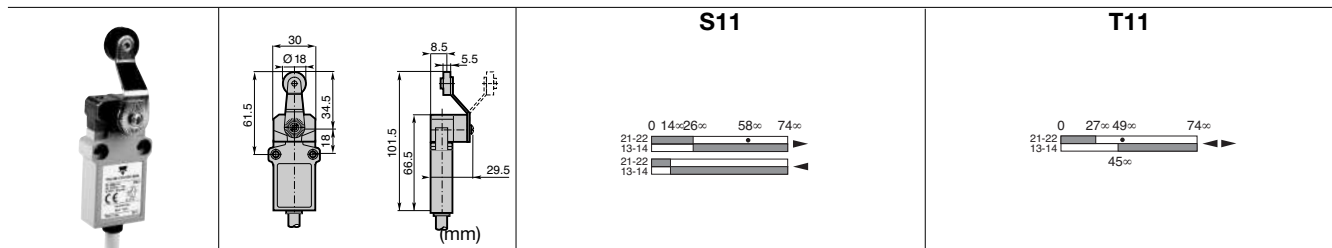

Conformity / (NC) / (NC)  
 Max. Actuation speed 1.5ms  
 Min. force or torque 0.08N / 0.28Nm  
 Weight 235g

**S11**  
 Ø18 nylon roller lever  
 Code

**T11**  
 PS31M-   BR-M00

# Limit Switches - Miniature Type (PS31M) Metal Body IP67



## ▣ Cable Characteristics

**C** = Pre-wired, 1m standard cable 4x0.75mm<sup>2</sup>  
**U** = Pre-wired, 1m UL cable 4x0.75mm<sup>2</sup>

(Different lengths available on request)

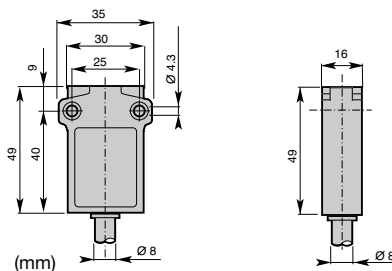

## ▲ Contact block (Zb type)

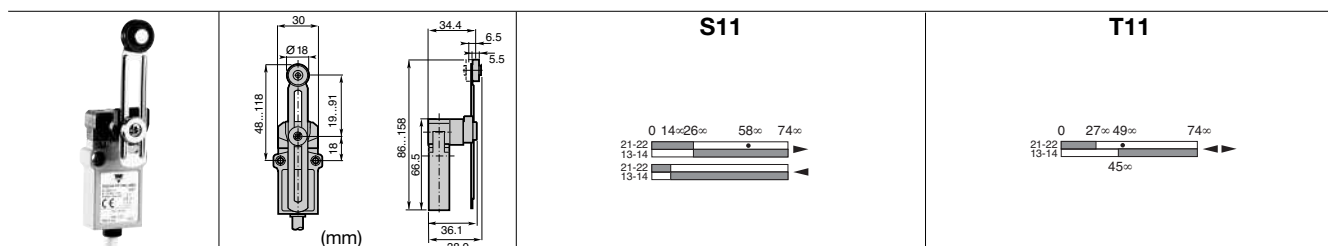
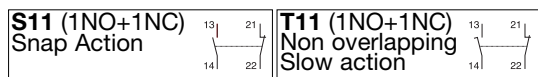

**Conformity** / (NC) / (NC)  
**Max. Actuation speed** 1.5ms  
**Min. force or torque** 0.08N / 0.28Nm  
**Weight** 245g

**Adjustable lever with Ø18 nylon roller**  
**Code** PS31M-▣▲R1-M00

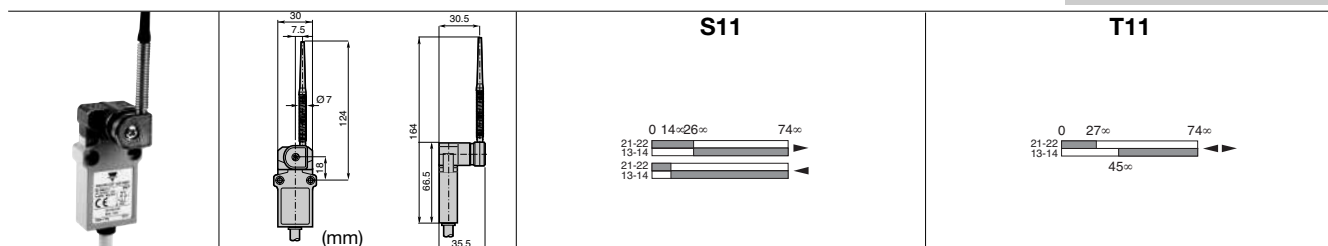

**Conformity** / (NC) / (NC)  
**Max. Actuation speed** 1.5ms  
**Min. force or torque** 0.08N / -  
**Weight** 245g

**Nylon actuator with stainless steel spring**  
**Code** PS31M-▣▲LB-M00

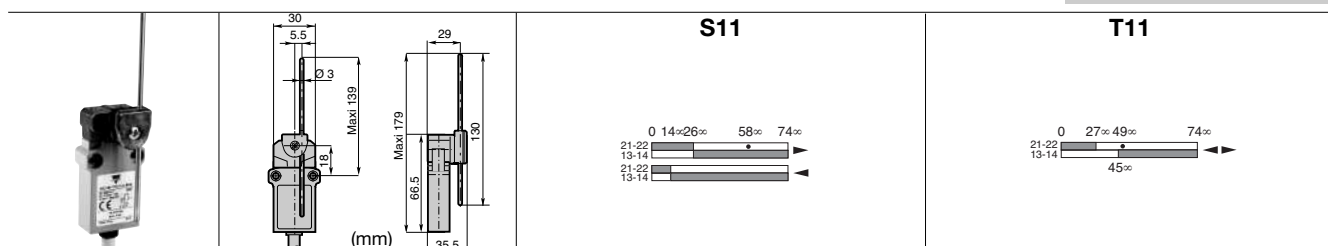

**Conformity** / (NC) / (NC)  
**Max. Actuation speed** 1.5ms  
**Min. force or torque** 0.08N / 0.28Nm  
**Weight** 240g

**Adjustable rod lever**  
**Code** stainless steel rod Ø3  
 fiberglass rod Ø3  
 square steel rod 3x3  
 PS31M-▣▲LA-M00  
 PS31M-▣▲LF-M00  
 PS31M-▣▲L3-M00

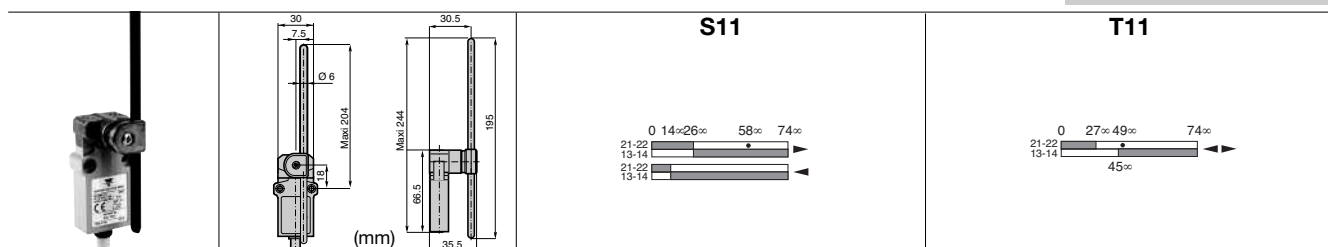

**Conformity** / (NC) / (NC)  
**Max. Actuation speed** 1.5ms  
**Min. force or torque** 0.08N / 0.28Nm  
**Weight** 255g

**Adjustable Ø6 rod lever**  
**Code** Nylon rod  
 fiberglass rod  
 PS31M-▣▲LN-M00  
 PS31M-▣▲LG-M00

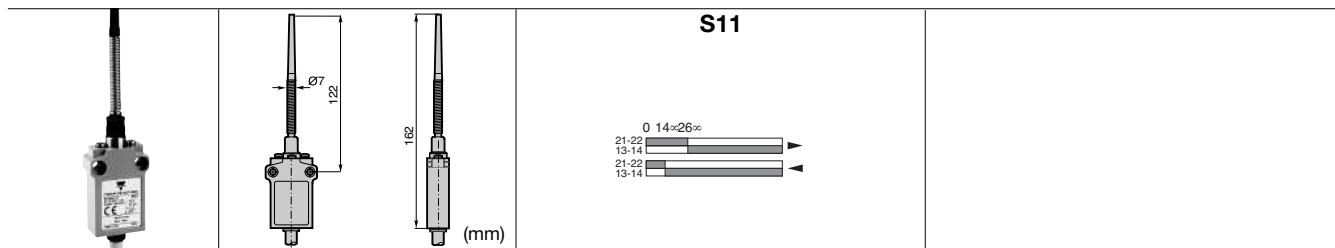

<b>Conformity /</b>	<b>(NC)</b>	<b>/</b>
<b>Max. Actuation speed</b>	1.0ms	
<b>Min. force or torque</b>	0.10N / -	
<b>Weight</b>	250g	

**Multidirectional nylon actuator with stainless steel spring**  
**Code** PS31M- LP-M00

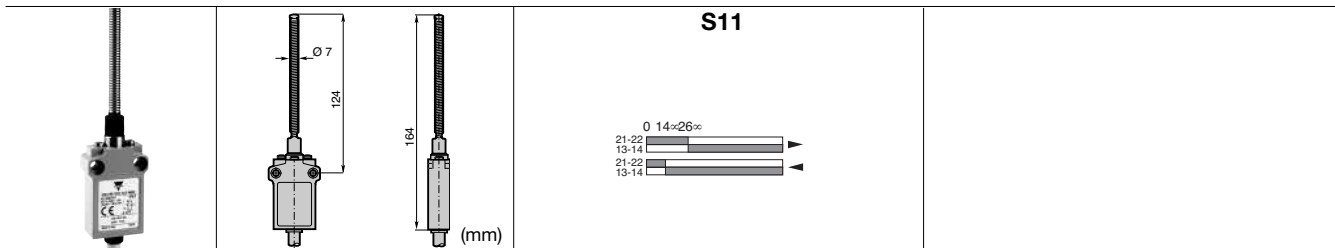

<b>Conformity /</b>	<b>(NC)</b>	<b>/</b>
<b>Max. Actuation speed</b>	1.0ms	
<b>Min. force or torque</b>	0.10N / -	
<b>Weight</b>	250g	

**Multidirectional actuator with stainless steel spring**  
**Code** PS31M- LS-M00

## Adjustment and utilization precautions

### Position adjustment of lever

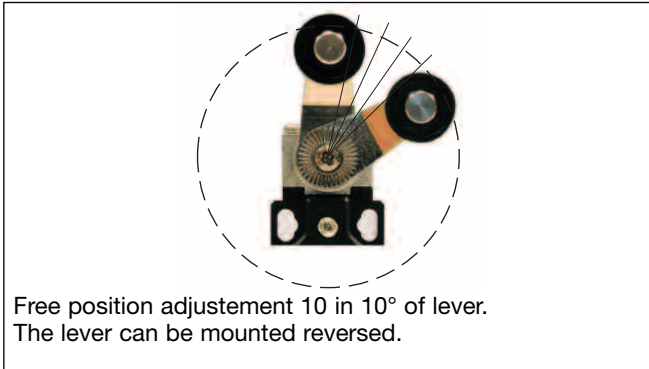

### Plain plunger

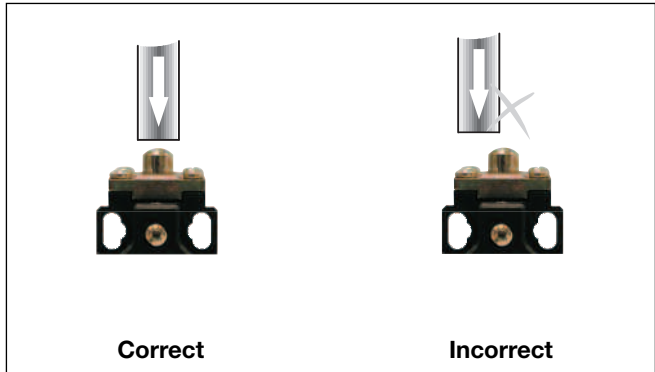

### Roller plunger or Roller lever

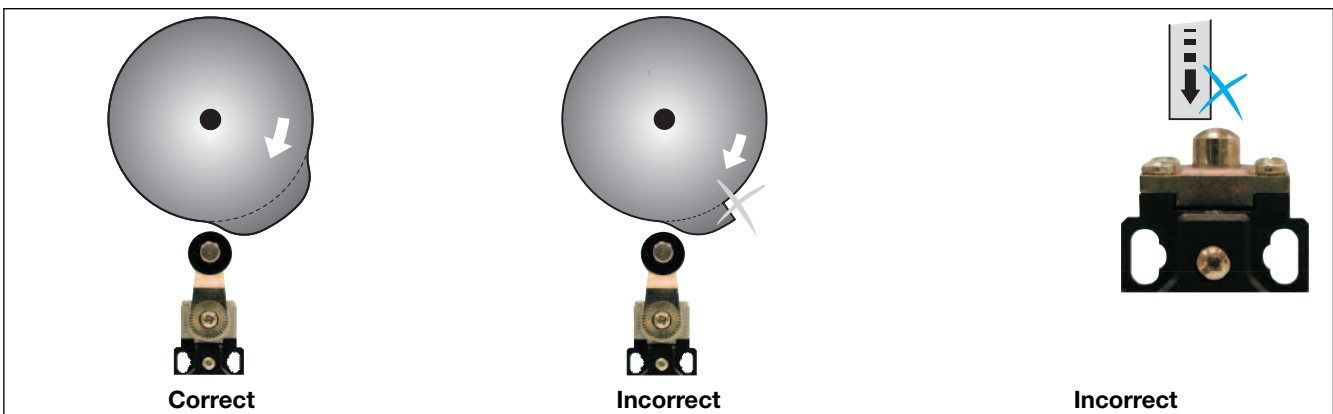
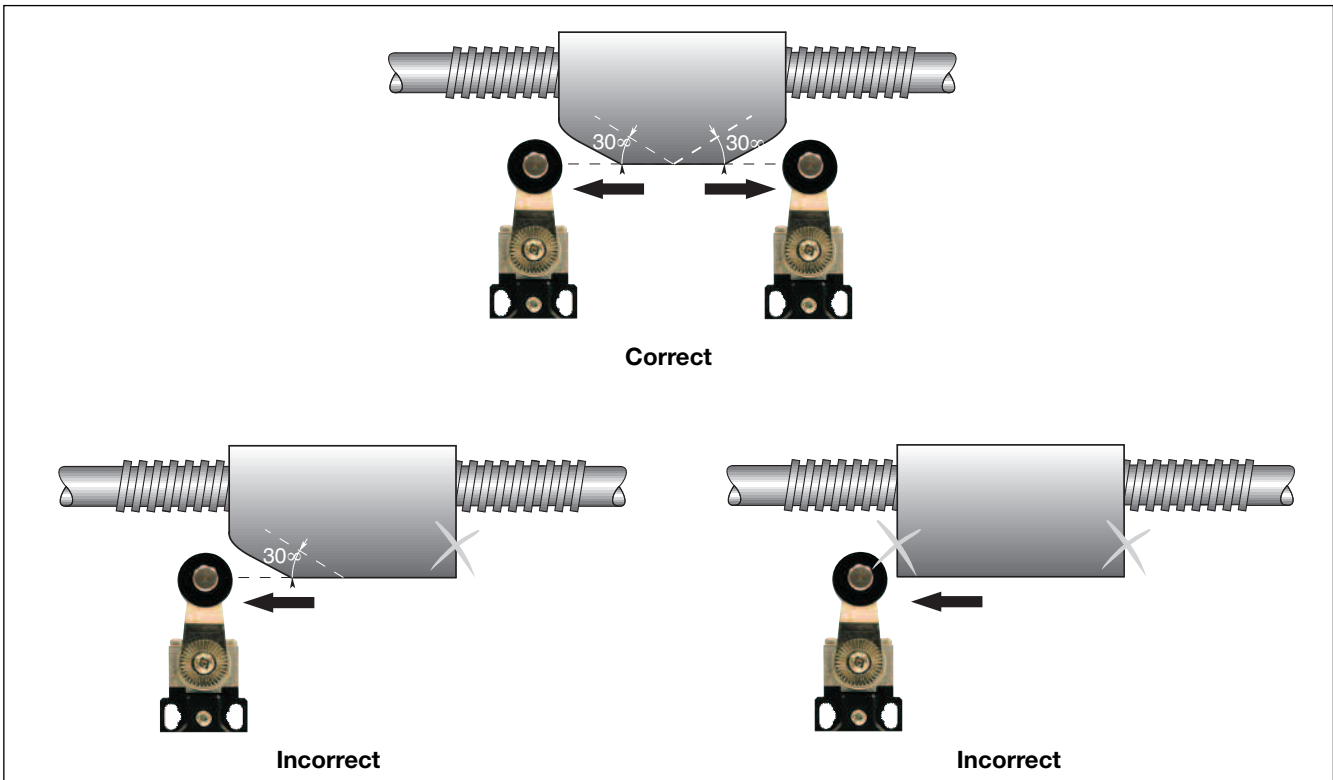

## X-ON Electronics

Largest Supplier of Electrical and Electronic Components

*Click to view similar products for [Limit Switches](#) category:*

*Click to view products by [Carlo Gavazzi](#) manufacturer:*

Other Similar products are found below :

[5ML1-E1](#) [5ML31](#) [LZG1](#) [LZL1-6C](#) [622EN114-R](#) [622EN18-6](#) [622EN224-6B](#) [622EN230](#) [622EN237-R](#) [622EN69-3](#) [622EN85-RB](#) [MA-10019](#)  
[6PA109](#) [7LS51](#) [83547001](#) [83725002](#) [83830001](#) [83840701](#) [83841001](#) [83881140](#) [8AS42](#) [8LS10](#) [8LS125-4PG](#) [8LS152-4PGN20](#) [914CE16-](#)  
[3A](#) [914CE3-3L1](#) [915PA10](#) [91MCE16-P2O](#) [924CE16-Y3](#) [924CE1-S6](#) [924CE1-T25A](#) [924CE1-T3](#) [924CE1-T9A](#) [924CE2-T9](#) [924CE31-Y20-](#)  
[X5](#) [924CE31-Y3L1](#) [GL-10054](#) [GLAB26J2B](#) [GLDB03C-6](#) [GLDC05C](#) [PS21R-NT11N7-YK0](#) [RDI-G-L5B](#) [DD-10000](#) [DT-2R3-A7](#) [14CE16-](#)  
[3N28](#) [14CE18-N15](#) [151ML3-E1](#) [E3102BAAAA](#) [BFL1-AW1-S](#) [1EN329-R](#)