

Solid State Relays 1-Phase with Integrated Heatsink Soft Start Switching Types RGC1P..K..



- 1-pole AC solid state contactors
- Soft start switching for short wave infrared heaters
- Rated operational voltage: up to 660 VAC
- Rated operational current: up to 63 AAC
- Control input: 24VDC
- Integrated varistor protection on output
- Load ON LED indication
- 100kA short circuit current rating according to UL508
- DIN or panel mount



Product Description

The RGC1P..K provides a solution for starting of loads having a high cold to hot resistance ratio and hence it is very common for such loads to exhibit a high inrush current when switched on from a cold state. Such behaviour is very common for short wave infrared heaters.

When a control signal is applied to the RGC1P..K, a soft start is performed. The soft start time is settable through

an accessible potentiometer. Once the soft start is complete, the RGC1P..K output switches ON and OFF according to the control signal. Soft starting is performed again if the control signal has been missing for more than 5 seconds.

The output of the RGC1P is protected against overvoltages by means of an integrated varistor across the output. Two front LEDs indicate the status of the load and control.

Specifications are at a surrounding temperature of 25°C unless otherwise specified.

Ordering Key

RGC 1 P 60 K 42 E D

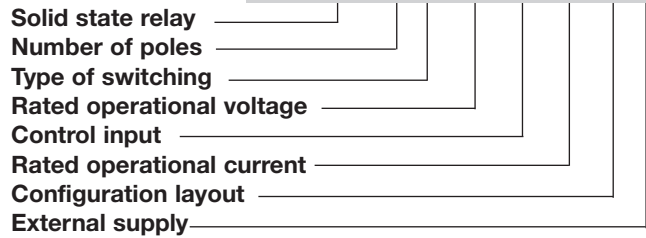

Type Selection

SSR with heatsink	Type of switching	Rated voltage (Ue), Blocking voltage	Control input	Rated current ¹ @40°C, I _{rt}	Connection configuration	External supply (Us)
RGC1: 1-pole switching	P: Proportional (Soft starting)	23: 85 - 265 VAC, 800 Vp	K: 24 VDC +/-20%	30: 30 AAC, 1800 A ² s 42: 43 AAC, 18000 A ² s 62: 63 AAC, 18000 A ² s	E: Contactor	D: 24 VDC/ AC
		48: 190 - 550 VAC, 1200 Vp				
		60: 410 - 660 VAC, 1200 Vp				

1: Refer to Current Derating

Selection Guide

Output voltage, Ue	Control input	External supply, Us	Power connection	Rated operational current @ 40°C (I ^{2t}) Product width		
				30 AAC (1800 A ² s) 35 mm	43 AAC (18000 A ² s) 35 mm	63 AAC (18000 A ² s) 70 mm
85 - 265 VAC	19.2 - 28.8 VDC	24 VDC/AC	Screw	RGC1P23K30ED	-	-
			Box	-	RGC1P23K42ED	RGC1P23K62ED
190 - 550 VAC	19.2 - 28.8 VDC	24 VDC/AC	Screw	RGC1P48K30ED	-	-
			Box	-	RGC1P48K42ED	RGC1P48K62ED
410 - 660 VAC	19.2 - 28.8 VDC	24 VDC/AC	Screw	RGC1P60K30ED	-	-
			Box	-	RGC1P60K42ED	RGC1P60K62ED

General Specifications

Operational frequency range	45 to 65 Hz	Pollution degree	2 (non-conductive pollution with possibilities of condensation)
Power factor	> 0.7 @ rated voltage	Rated impulse withstand voltage, U _{imp}	6 kV (1.2/50µs)
Touch Protection	IP20	Over-voltage category	III (fixed installations)
LED status indication ²	Green	Control ON, fully ON Supply ON, flashing 0.5s ON, 0.5s OFF	Isolation L1, T1, A1, GND, Us to case L1, T1 to A1, GND, Us
	Yellow	Load ON	
		4000 Vrms 2500 Vrms	

2: Refer to LED Indications section

Output Voltage Specifications

	RGC1P23..	RGC1P48..	RGC1P60..
Operational voltage range (Ue)	85-265 VAC	190-550 VAC	410-660 VAC
Blocking voltage	800 Vp	1200 Vp	1200 Vp
Leakage current @ rated voltage	≤ 5 mAAC	≤ 5 mAAC	≤ 5 mAAC
Internal Varistor across output	Yes	Yes	Yes

Output Specifications

	RGC1P..30	RGC1P..42	RGC1P..62
Rated operational current per pole ³ AC-51 @ Ta=25 °C AC-51 @ Ta=40 °C AC-55b @ Ta=40 °C	30 AAC 30 AAC 30 AAC	50 AAC 43 AAC 43 AAC	73 AAC 63 AAC 63 AAC
Minimum operational current	250 mAAC	500 mAAC	500 mAAC
Rep. Overload Current PF = 0.7 UL508: T=40°C, tON=1s, tOFF=9s, 50cycles	84 AAC	126 AAC	168 AAC
Maximum transient surge current (I _{tsm}), t=10ms	600 Ap	1900 Ap	1900 Ap
I ^{2t} for fusing (t=10ms), minimum	1800 A ² s	18000 A ² s	18000 A ² s
Critical dv/dt (@ T _j init = 40°C)	1000 V/us	1000 V/us	1000 V/us

3: refer to Current Derating



Input Specifications

Control input (A1 - GND)	19.2 - 28.8 VDC
Pick up voltage	19.2 VDC
Drop out voltage	10.0 VDC
Maximum initialisation time	250 ms
Response time (Input to Output)	2 half cycles
Input impedance	100k ohms
Reverse protection	Yes
Input protection vs. surges ⁴	Yes
Overvoltage protection	up to 30 VDC

Supply Specifications

Supply voltage range (Us) ⁵	24 VDC, -15% / +20% 24 VAC, -15% / +15%
Overvoltage protection	up to 32 VDC/AC for 30 sec.
Reverse Protection	Yes
Surge Protection ⁴	Yes, integrated
Max. supply current	30 mA

4: Refer to Electromagnetic Compatibility section

5: To be supplied from a Class 2 power source

Output Power Dissipation

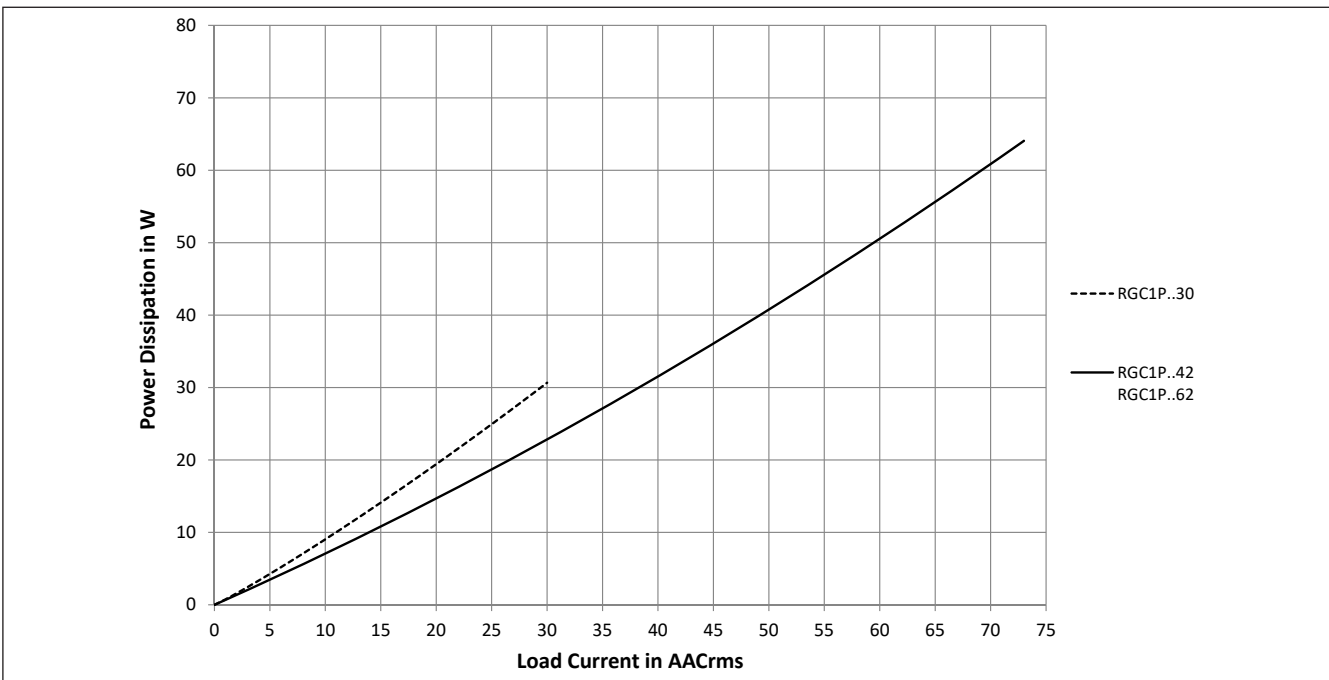

Current Derating (UL508)

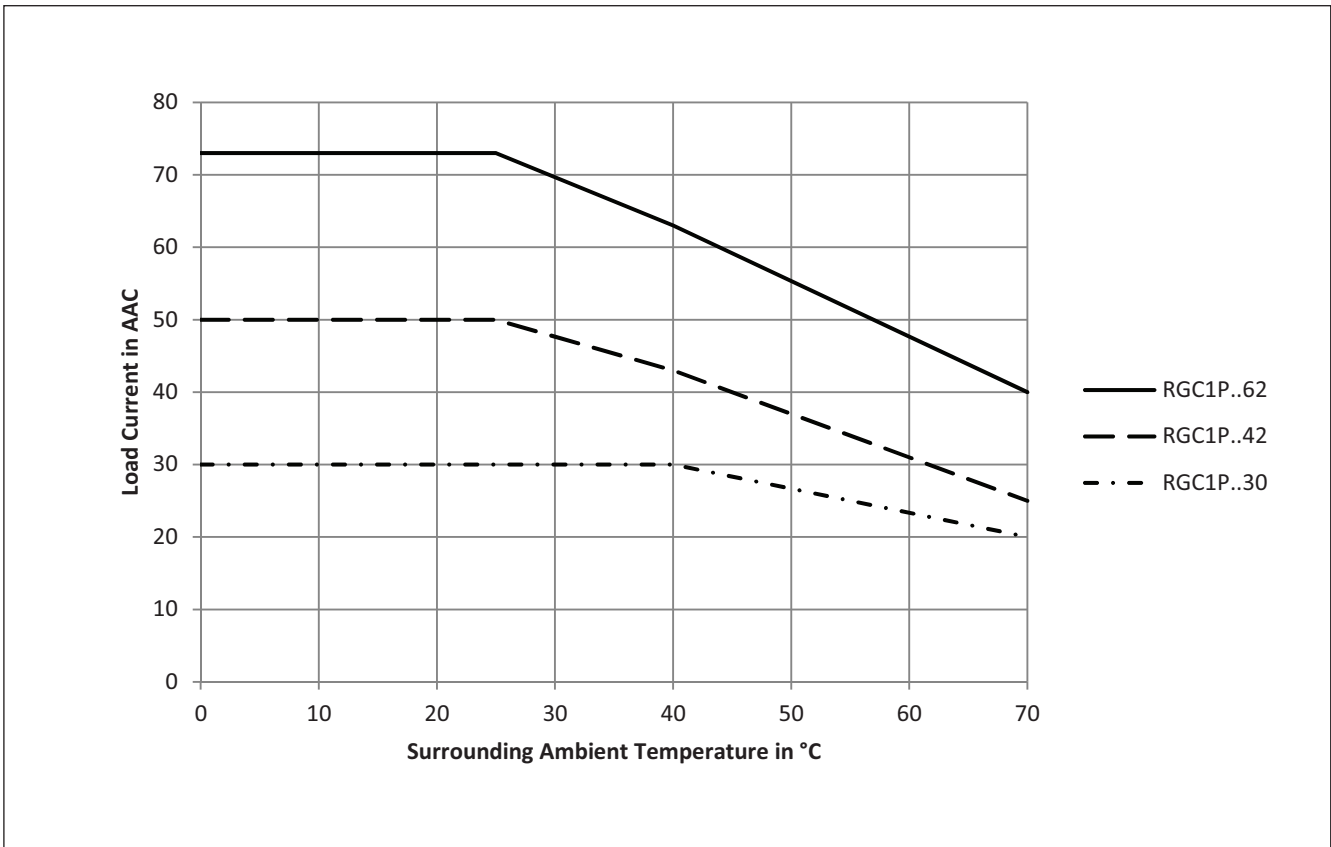

Current Derating vs. Spacing Curves

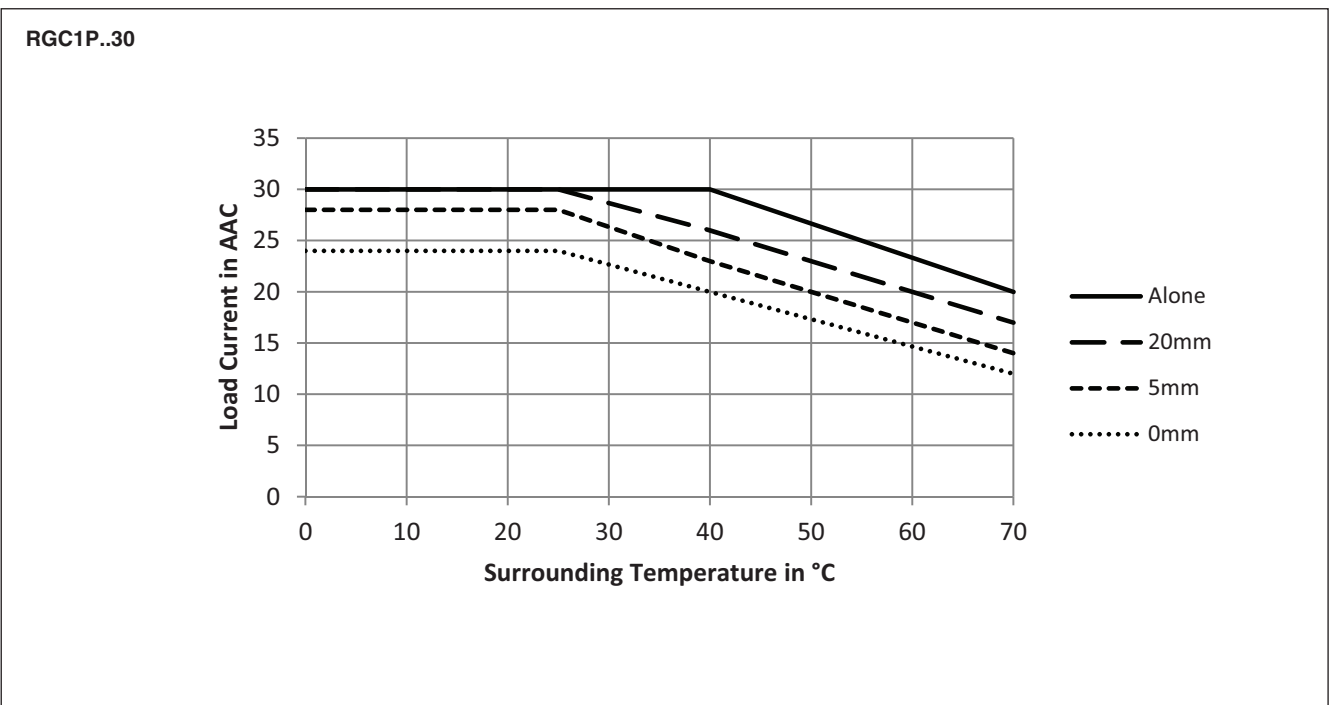

Current Derating vs. Spacing Curves

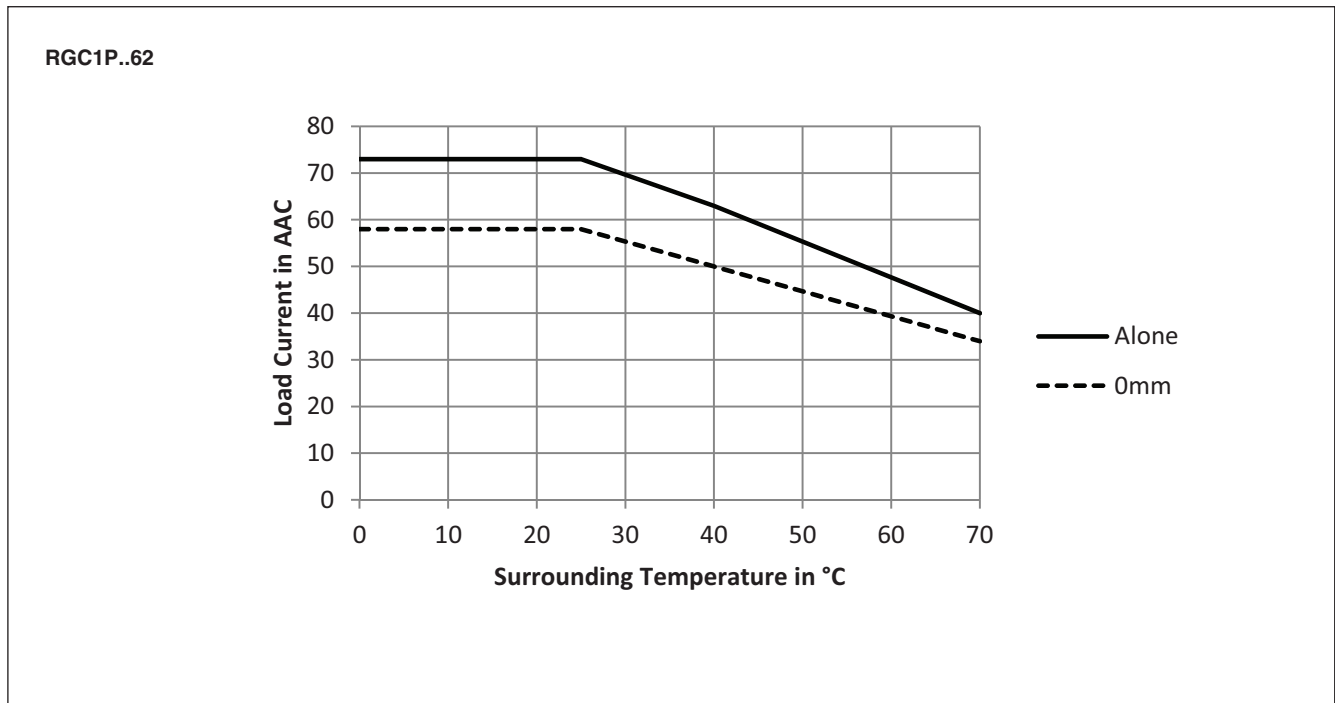
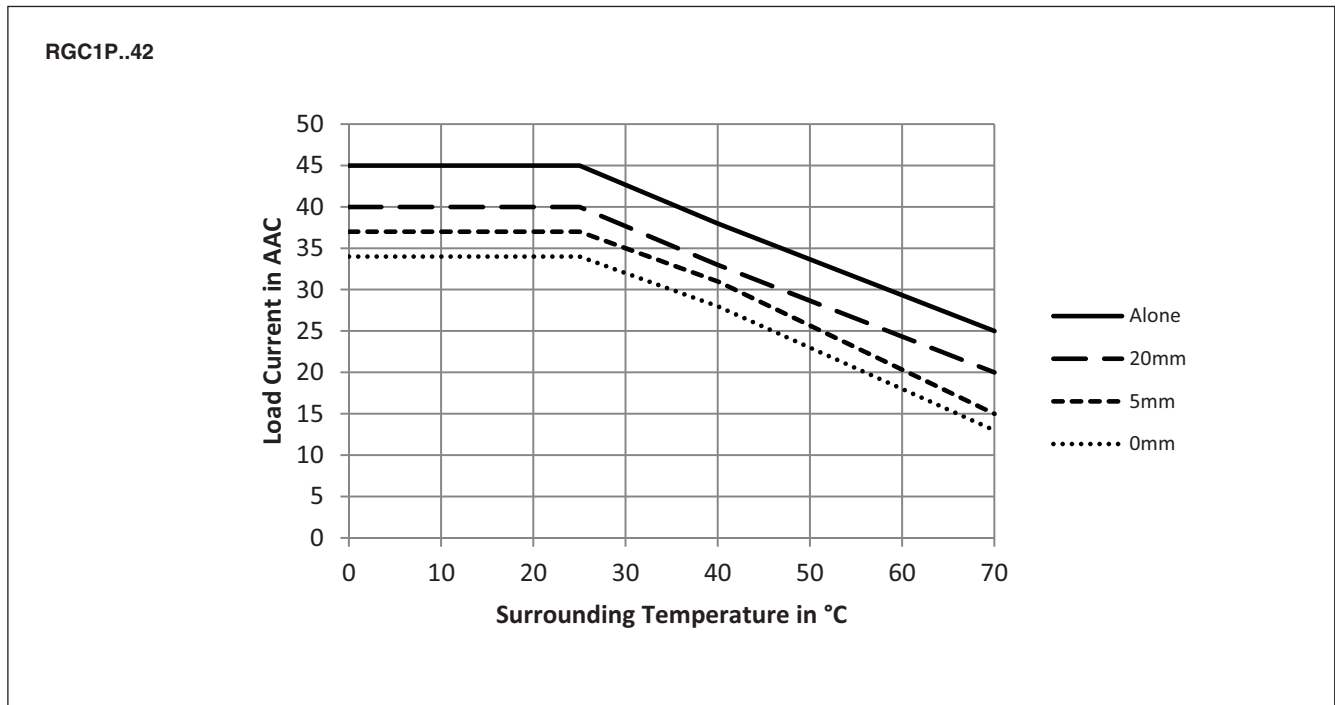

Environmental and Housing Specifications

Operating Temperature	-40°C to +70°C (-40°F to +158°F)	UL flammability rating (for plastic)	UL 94 V0 Glow wire ignition temperature and Glow wire flammability index conform to EN 60335-1 requirements
Storage Temperature	-40°C to +100°C (-40°F to +212°F)		
EU RoHS compliant	Yes		
China RoHS compliant	Refer to Environmental Information (page 15)		
Impact resistance (EN50155, EN61373)	15/11 g/ms	Installation altitude	0-1000m. Above 1000m derate linearly by 1% of FLC per 100m up to a maximum of 2000m
Vibration resistance (2-100Hz, IEC60068-2-6, EN50155, EN61373)	2g per axis	Weight RGC1P..30, 42 RGC1P..62	approx. 450g approx. 805g
Relative humidity	95% non-condensing @ 40°C		
Material	PA66, RAL7035		

Product Interface

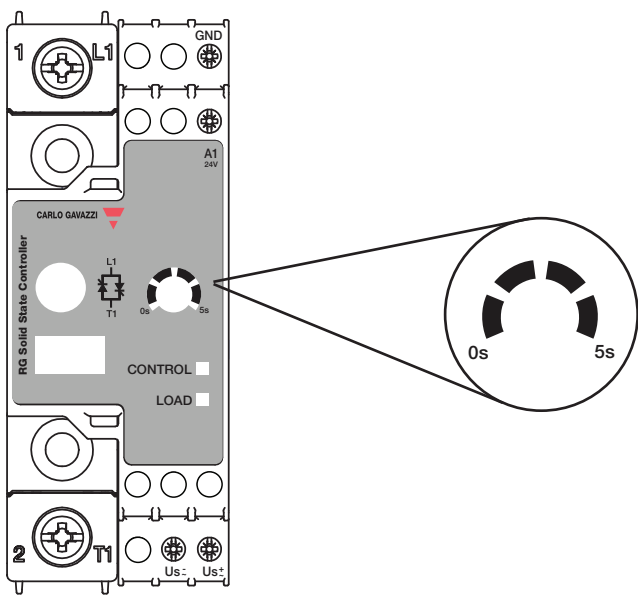

Terminals Labelling:

- 1/L1: Line connection
- 2/T1: Load connection
- A1-GND: Control input, 19.2 - 28.8 VDC
- Us (+, ~): External supply, positive signal or AC signal
- Us (-, ~): External supply, ground or AC signal

Ramp up time setting for soft starting

LED Indications

LED	Status	Timing Diagram
CONTROL (green)	Supply voltage (Us) ON	[Pulse]
	Control input ON	[Pulse]
	Mains loss	[Pulse]
	SSR internal error	[Pulse]
LOAD (yellow)	LOAD ON	[Pulse]

Agency Approvals and Conformances

Conformance	IEC/EN 60947-4-3	Agency Approvals	UL Listed: UL508, NMFT E172877 cUL Listed: CSA 22.2 No.14-13, NMFT7 E172877
		Short Circuit Current Rating	100kArms, UL508



Electromagnetic Compatibility

EMC Immunity	EN 60947-4-3	Electrical fast transient (Burst) immunity	EN/IEC 61000-4-4 Performance Criteria 1 Performance Criteria 1 Performance Criteria 1
Electrostatic discharge (ESD) immunity Air discharge, 8 kV Contact, 4 kV	EN/IEC 61000-4-2 Performance Criteria 2 Performance Criteria 2	Output: 2kV, 5 kHz Us: 2kV, 5 kHz A1, GND: 1 kV, 5 kHz	
Electrical surge immunity Output, line to line, 1 kV Output, line to earth, 2 kV A1, GND Line to earth, 1 kV Us +, Us - Line to line, 500 V Line to earth, 500 V	EN/IEC 61000-4-5 Performance Criteria 2 Performance Criteria 2 Performance Criteria 2 Performance Criteria 2 Performance Criteria 2	Radiated radio frequency immunity 10V/m, 80 - 1000 MHz 10V/m, 1.4 - 2.0 GHz 3V/m, 2.0 - 2.7 GHz	EN/IEC 61000-4-3 Performance Criteria 1 Performance Criteria 1 Performance Criteria 1
		Conducted radio frequency immunity 10V/m, 0.15 - 80 MHz	EN/IEC 61000-4-6 Performance Criteria 1
		Voltage Dips 0% for 0.5, 1 cycle 40% for 10 cycles 70% for 25 cycles 80% for 250 cycles	EN/IEC 61000-4-11 Performance Criteria 2 Performance Criteria 2 Performance Criteria 2 Performance Criteria 2
		Voltage Interruptions 0% for 5000 ms	EN/IEC 61000-4-11 Performance Criteria 2
EMC Emission	EN 60947-4-3	Radio interference field emission (radiated) 30 - 1000 MHz	EN/IEC 55011 Class A (industrial)
Radio interference voltage emission (conducted) 0.15 - 30 MHz	EN/IEC 55011 Class A (with external filtering)		

Note:

- Control input lines must be installed together to maintain products susceptibility to Radio Frequency Interference.
 - Use of AC solid state relays may according to the application and the load current, cause conducted radio interferences. Use of mains filters may be necessary for cases where the user must meet E.M.C requirements. The filtering tables should be taken only as indications, the filter attenuation will depend on the final application.
 - This product has been designed for Class A equipment. (External filtering may be required, refer to filtering section). Use of this product in domestic environments may cause radio interference, in which case the user may be required to employ additional mitigation methods.
 - Surge tests on RGC..A models were carried out with the signal line impedance network. In case the line impedance is less than 40Ω, it is suggested that AC supply is provided through a secondary circuit where the short circuit limit between conductors and ground is 1500VA or less.
 - A deviation of one step in the distributed full cycle models and up to 1.5% Full Scale Deviation in phase angle models is considered to be within PC1 criteria.
- Performance Criteria 1 (Performance Criteria A): No degradation of performance or loss of function is allowed when the product is operated as intended.
- Performance Criteria 2 (Performance Criteria B): During the test, degradation of performance or partial loss of function is allowed. However, when the test is complete the product should return operating as intended by itself.
- Performance Criteria 3 (Performance Criteria C): Temporary loss of function is allowed, provided the function can be restored by manual operation of the control.

Mode of Operation

Soft starting is utilised to reduce the start-up current of loads having a high cold to hot resistance ratio such as short wave infrared heaters. The thyristor firing angle is gradually increased over a time period of maximum 5 seconds (settable through an accessible potentiometer) in order to apply the voltage (and current) to the load smoothly.

Soft starting is performed only on the first power up and when the control voltage has been missing in the preceding 5 seconds. If soft start is stopped before soft start completion, it is assumed that a start was performed and the period count for missing control voltage starts as soon as the soft start is stopped.

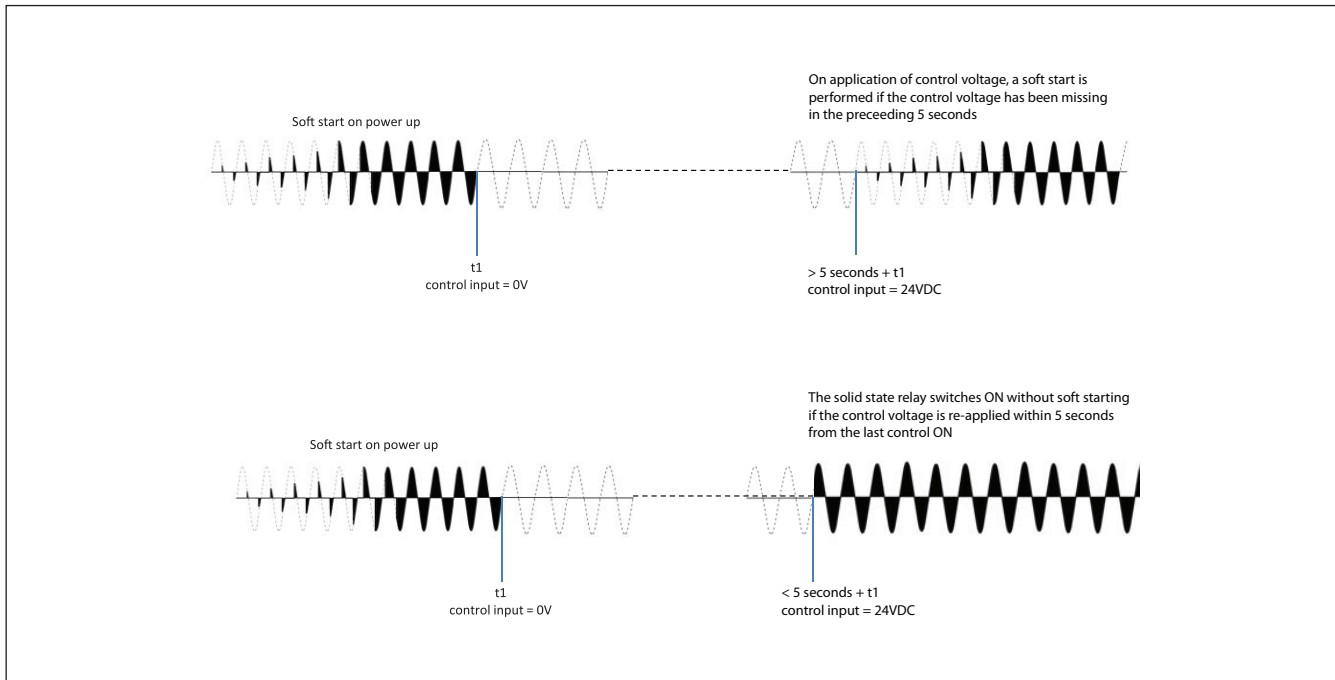

Dimensions

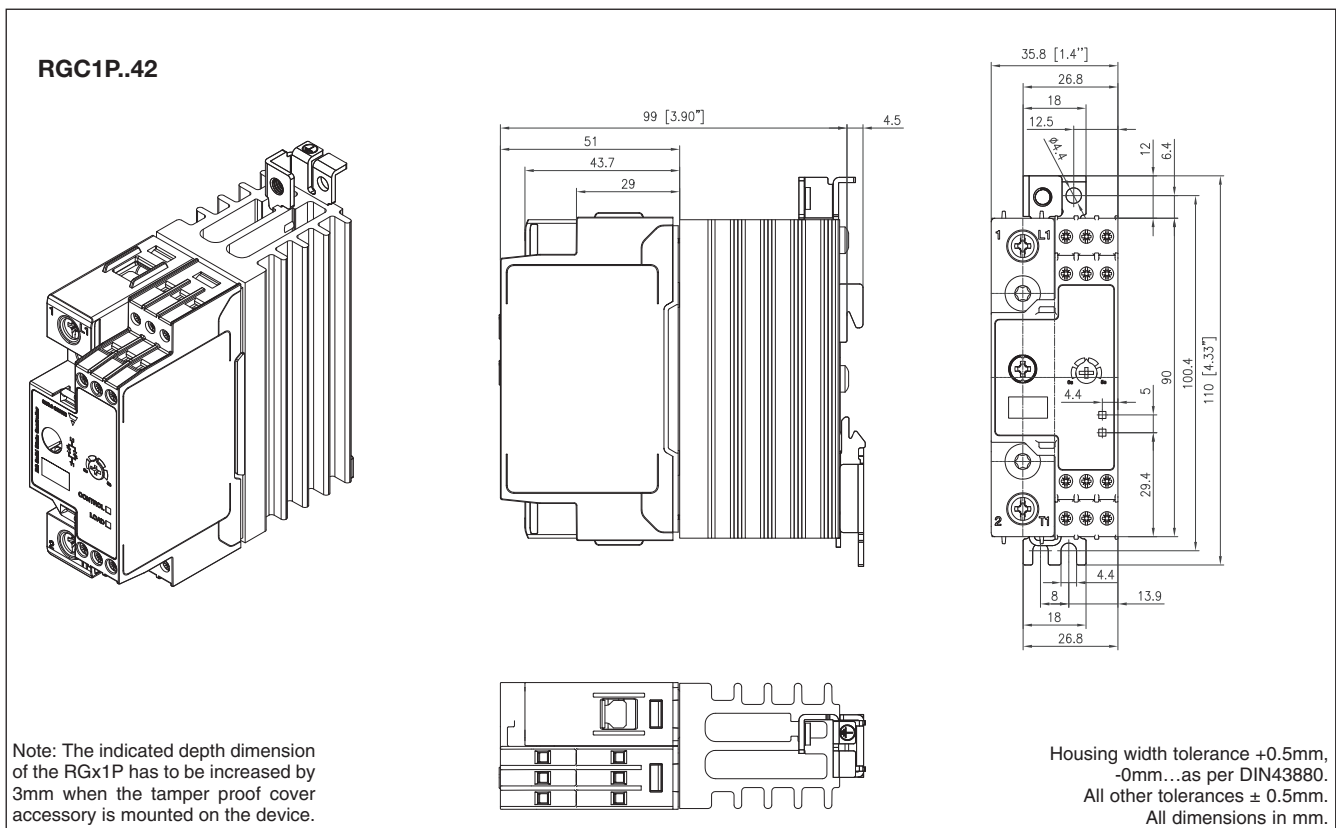
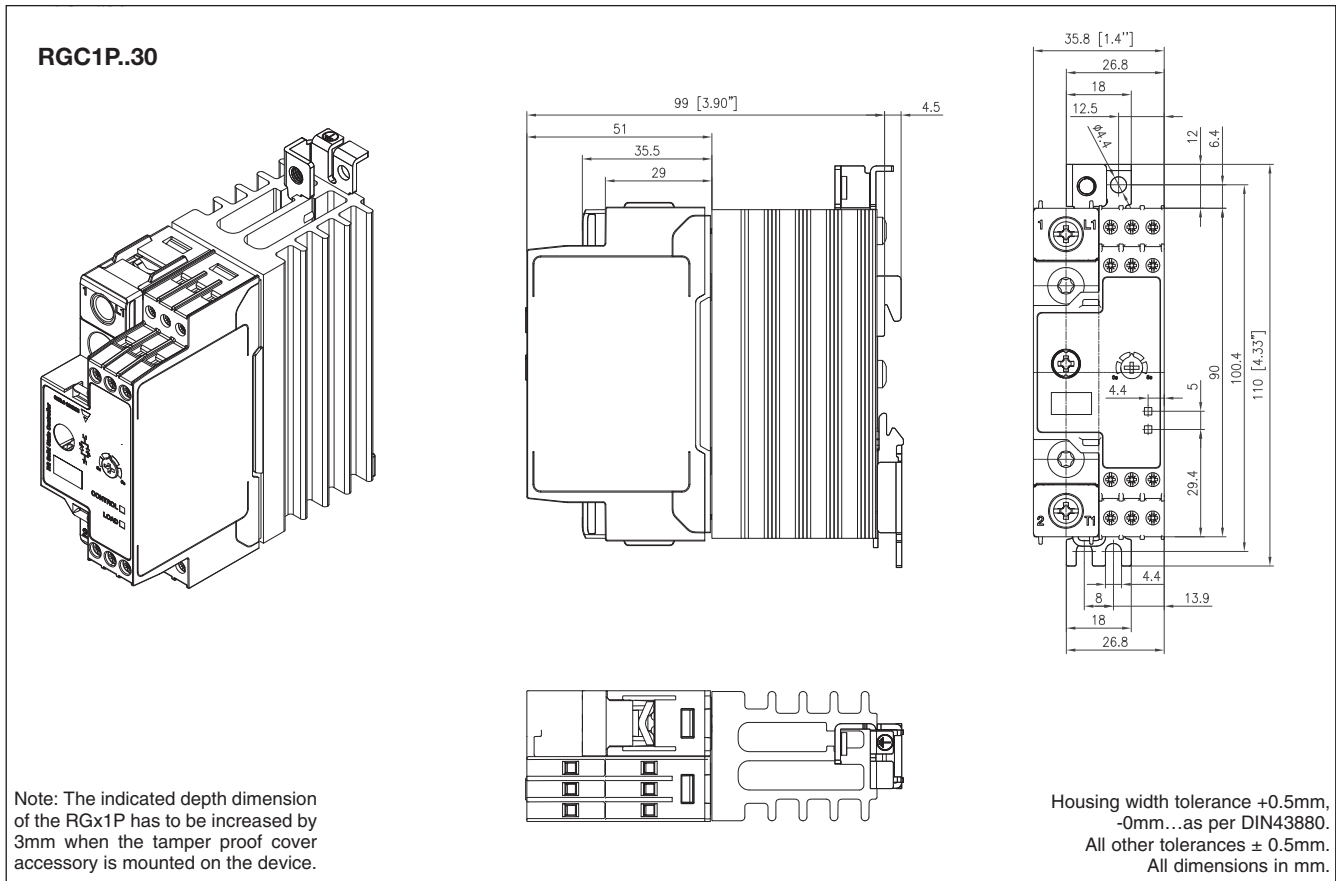

Dimensions

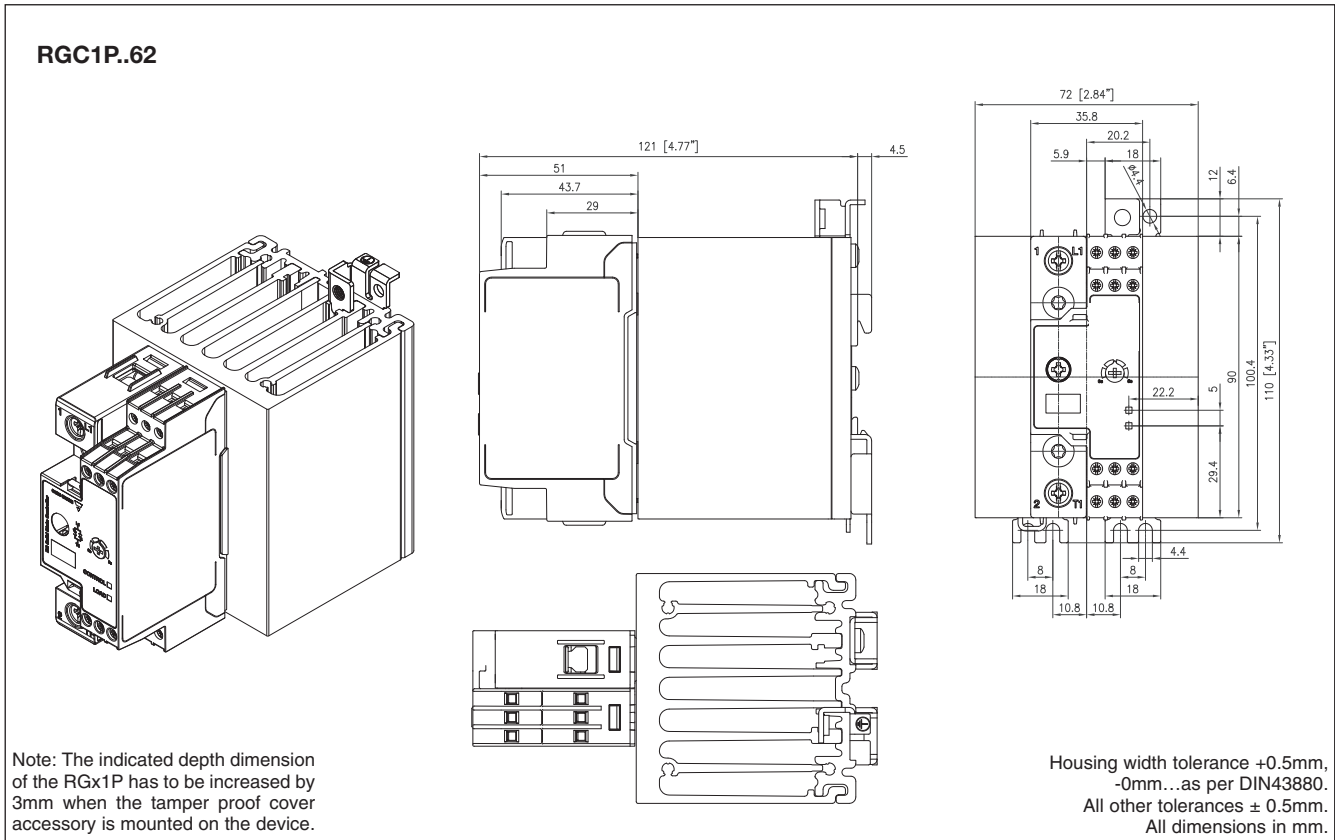

Connection Diagram

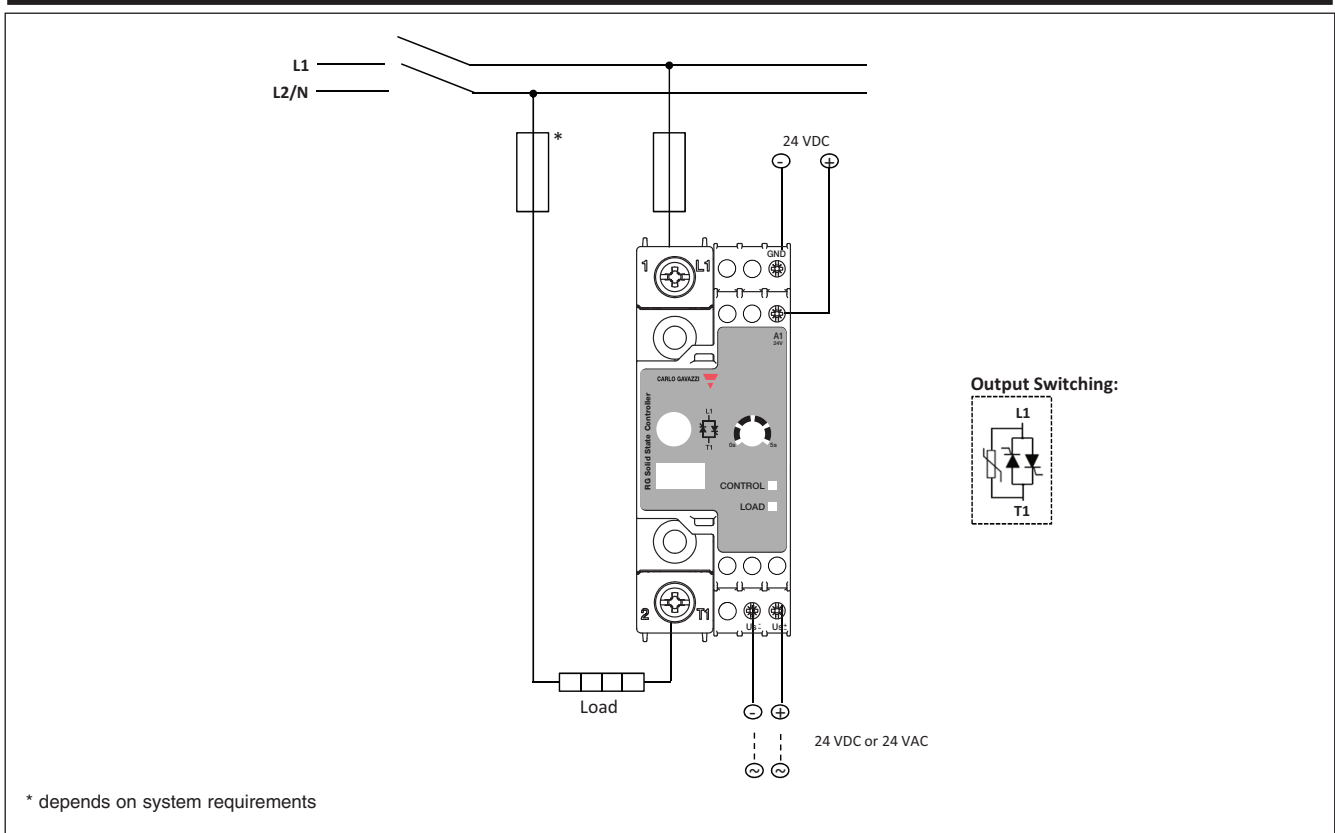

Connection Specifications

POWER CONNECTIONS





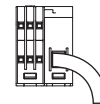
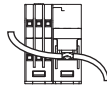

1/L1, 2/T1

Use 75°C copper (Cu) conductors

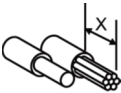
RGC1P..30

RGC1P..42, RGC1P..62



Stripping length (X)		12mm		11mm
Connection type		M4 screw with captivated washer		M5 screw with box clamp
Rigid (solid & stranded) UL/cUL rated data		2x 2.5 - 6.0 mm ² 2x 14 - 10 AWG	1x 2.5 - 6.0 mm ² 1x 14 - 10 AWG	1x 2.5 - 25 mm ² 1x 14 - 3 AWG
Flexible with end sleeve		2x 1.0 - 2.5 mm ² 2x 2.5 - 4.0 mm ² 2x 18 - 14 AWG	1x 1.0 - 4.0 mm ² 1x 18 - 12 AWG	1x 2.5 - 16 mm ² 1x 14 - 6 AWG
Flexible without end sleeve		2x 1.0 - 2.5 mm ² 2x 2.5 - 6.0 mm ² 2x 18 - 14 AWG	1x 1.0 - 6.0 mm ² 1x 18 - 10 AWG	1x 4.0 - 25 mm ² 1x 12 - 3 AWG
Torque specification		Pozidriv 2 UL: 2Nm (17.7 lb-in) IEC: 1.5-2.0Nm (13.3-17.7 lb-in)		Pozidriv 2 UL: 2.5Nm (22 lb-in) IEC: 2.5-3.0Nm (22-26.6 lb-in)
Aperture for termination lug		12.3mm		n/a
Protective Earth (PE) connection	 		M5, 1.5Nm (13.3 lb-in)	



Not provided with SSR. PE connection required when product is intended to be used in Class 1 applications according to EN/IEC 61140

CONTROL CONNECTIONS

Use 60/75°C copper (Cu) conductors

GND, A1, Us

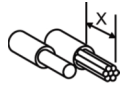

Stripping length (X)		8 mm
Connection type		M3 screw with box clamp
Rigid (solid & stranded) UL/cUL rated data		1x 1.0 - 2.5 mm ² 1x 18 - 12 AWG
Flexible with end sleeve		1x 0.5 - 2.5 mm ² 1x 20 - 12 AWG
Torque specification		Pozidriv 1 UL: 0.5Nm (4.4 lb-in) IEC: 0.4-0.5Nm (3.5-4.4 lb-in)

Mounting Instructions

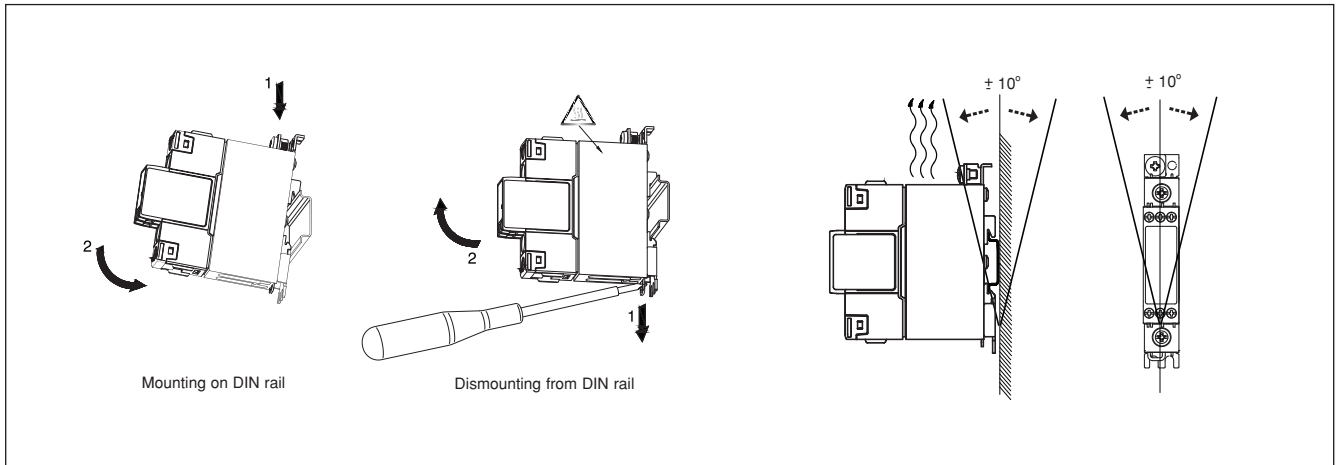

Installation Instructions

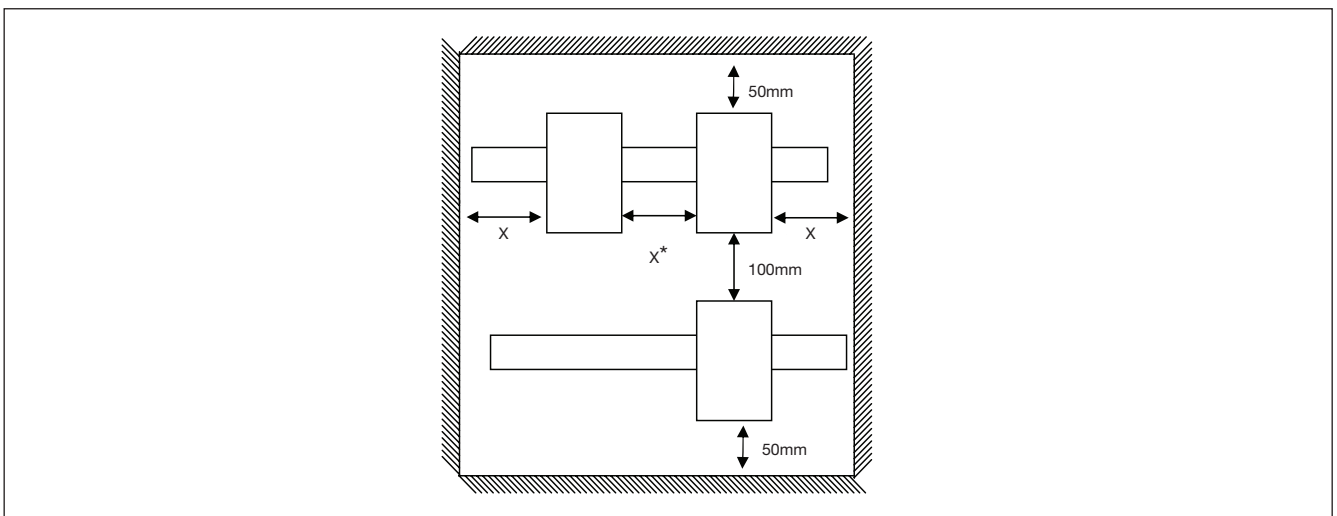

* Refer to Current Derating vs spacing curves. Spacing between SSR and panel walls should be >5mm.

Short Circuit Protection

Protection Co-ordination, Type 1 vs Type 2:

Type 1 protection implies that after a short circuit, the device under test will no longer be in a functioning state. In type 2 co-ordination the device under test will still be functional after the short circuit. In both cases, however the short circuit has to be interrupted. The fuse between enclosure and supply shall not open. The door or cover of the enclosure shall not be blown open. There shall be no damage to conductors or terminals and the conductors shall not separate from terminals. There shall be no breakage or cracking of insulating bases to the extent that the integrity of the mounting of live parts is impaired. Discharge of parts or any risk of fire shall not occur.

The product variants listed in the table hereunder are suitable for use on a circuit capable of delivering not more than 100,000A Symmetrical Amperes, 600Volts maximum when protected by fuses. Tests at 100,000Arms were performed with Class J fuses, fast acting; please refer to the tables below for maximum ratings. Tests with Class J fuses are representative of Class CC fuses.

Co-ordination type 1 (UL508)

Part No.	Short circuit current [kArms]	Max. fuse size [A]	Class	Voltage [VAC]
RGC1P..30	100	30	J or CC	Max. 600
RGC1P..42	100	80	J	Max. 600
RGC1P..62	100	80	J	Max. 600

Co-ordination type 2 (EN/IEC 60947-4-3)

Part No.	Short circuit current [kArms]	Ferraz Shawmut (Mersen)		Siba		Voltage [VAC]
		Max. fuse size [A]	Part No.	Max. fuse size [A]	Part No.	
RGC1P..30	10	40	6.9xx CP GRC 22x58 /40	32	50 142 06.32	Max. 600
	100	40	6.9xx CP URD 22x58 /40	32	50 142 06.32	Max. 600
RGC1P..42	10	63	6.9xx CP URC 14x51 /63	80	50 142 20.80	Max. 600
	10	70	A70QS70-4	80	50 142 20.80	Max. 600
	100	63	6.9xx CP URC 14x51 /63	80	50 142 20.80	Max. 600
	100	70	A70QS70-4	80	50 142 20.80	Max. 600
RGC1P..62	10	100	6.9xx CP GRC 22x58 /100	100	50 142 20.100	Max. 600
	10	100	A70QS100-4	100	50 142 20.100	Max. 600
	100	100	6.621 CP URGD 27x60 /100	100	50 142 20.100	Max. 600
	100	100	A70QS100-4	100	50 142 20.100	Max. 600

xx = 00, without fuse trip indication

xx = 21, with fuse trip indication

Type 2 Protection with Miniature Circuit Breakers (M.C.B.s)

Solid State Relay type	ABB Model no. for Z - type M. C. B. (rated current)	ABB Model no. for B - type M. C. B. (rated current)	Wire cross sectional area [mm ²]	Minimum length of Cu wire conductor [m] ⁶
RGC1P.30 (1800 A ² s)	1 pole S201 - Z10 (10A)	S201-B4 (4A)	1.0	7.6
			1.5	11.4
			2.5	19.0
	S201 - Z16 (16A)	S201-B6 (6A)	1.0	5.2
			1.5	7.8
			2.5	13.0
	S201 - Z20 (20A)	S201-B10 (10A)	1.5	12.6
			2.5	21.0
	S201 - Z25 (25A)	S201-B13 (13A)	2.5	25.0
			4.0	40.0
	2 pole S202 - Z25 (25A)	S202-B13 (13A)	2.5	19.0
			4.0	30.4
RGC1P.42 RGC1P.62 (18000 A ² s)	1 pole S201-Z32 (32A)	S201-B16 (16A)	2.5	3.0
			4.0	4.8
			6.0	7.2
	S201-Z50 (50A)	S201-B25 (25A)	4.0	4.8
			6.0	7.2
			10.0	12.0
			16.0	19.2
	S201-Z63 (63A)	S201-B32 (32A)	6.0	7.2
			10.0	12.0
			16.0	19.2

6. Between MCB and Load (including return path which goes back to the mains).

Note: A prospective current of 6kA and a 230/400V power supply system is assumed for the above suggested specifications. For cables with different cross section than those mentioned above please consult Carlo Gavazzi's Technical Support Group.

Environmental Information

The declaration in this section is prepared in compliance with People's Republic of China Electronic Industry Standard SJ/T11364-2014: Marking for the Restricted Use of Hazardous Substances in Electronic and Electrical Products.

Part Name	Toxic or Harardous Substances and Elements					
	Lead (Pb)	Mercury (Hg)	Cadmium (Cd)	Hexavalent Chromium (Cr(VI))	Polybrominated biphenyls (PBB)	Polybrominated diphenyl ethers (PBDE)
Power Unit Assembly	x	○	○	○	○	○

O: Indicates that said hazardous substance contained in homogeneous materials for this part are below the limit requirement of GB/T 26572.

X: Indicates that said hazardous substance contained in one of the homogeneous materials used for this part is above the limit requirement of GB/T 26572.

环境特性

这份申明根据中华人民共和国电子工业标准 SJ/T11364-2014：标注在电子电气产品中限定使用的有害物质

零件名称	有毒或有害物质与元素					
	铅 (Pb)	汞 (Hg)	镉 (Cd)	六价铬 (Cr(VI))	多溴化联苯 (PBB)	多溴联苯醚 (PBDE)
功率单元	x	○	○	○	○	○

O: 此零件所有材料中含有的该有害物低于GB/T 26572的限定。

X: 此零件某种材料中含有的该有害物高于GB/T 26572的限定。



Accessories

Tamper Proof Accessory Kit



Ordering Key

RGTMP

Tamper proof accessory kit for RGS1P, RGC1P series containing:
- x5 transparent covers
- x5 secureness ties

Installation

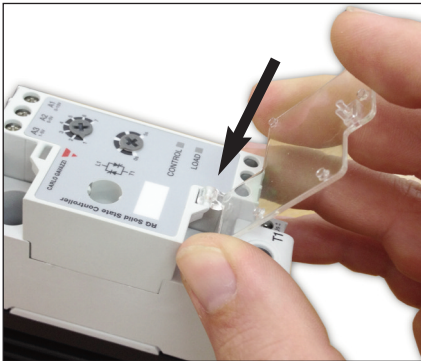

1: Clip hook of the transparent cover to the bottom loop of the RGx1P control module

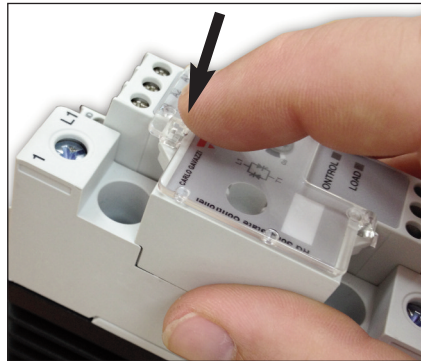

2: Close the cover by clipping to the top loop of the RGx1P control module

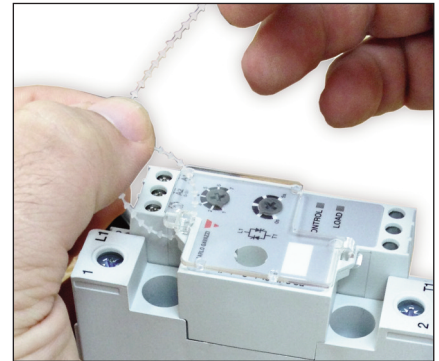

3: Secure with provided tie

X-ON Electronics

Largest Supplier of Electrical and Electronic Components

Click to view similar products for [Solid State Relays - Industrial Mount](#) category:

Click to view products by [Carlo Gavazzi](#) manufacturer:

Other Similar products are found below :

[D2440-C](#) [H10CA4890](#) [D4875C](#) [D53TP50DH-10](#) [1395831-1](#) [1616010-6](#) [BR312BY](#) [A-1326](#) [H10CA4850](#) [H12CA4890VL](#) [RA2410-D06](#)
[RA2410HA06T](#) [D1202F](#) [D53TP50-10](#) [W230E-1-12](#) [W230T-3-12](#) [1-1617030-3](#) [1-1617033-7](#) [MS2-D2420](#) [MS2-D2430](#) [A-1440](#)
[RJ1P60V50E](#) [HS501DR-D2425](#) [RN1F48I50](#) [70.362.1028.0](#) [7-1393030-8](#) [Z5.509.0828.0](#) [G3DZ-4B DC24](#) [G3DZ-F4B DC12](#) [SSRDAC10](#)
[RV8S-L-A240-D24](#) [RV8S-L-A240-D6](#) [RV8S-S-A240-D24](#) [RV8S-S-A240-D6](#) [RV8S-S-A240Z-D24](#) [RV8S-S-D24-A240](#) [RV8S-S-D48-A120](#)
[RN1F12V50](#) [RJ1P60I30E](#) [RJ1P60V30E](#) [SO967860](#) [SMT8628521](#) [SO869970](#) [SOD867180](#) [SAL961360](#) [SO867970](#) [SOB863860](#)
[SOB867640](#) [SOB942360](#) [G3PH-5150B DC5-24](#)