

# RGS..E, RGS..EDIN



## 1-Phase Solid State Relays, 'E'- type connection



### Benefits

- **Panel space savings.** Product width of only 17.5 mm giving up to 60% space savings compared to the standard hockey puck platform.
- **Less maintenance costs.** Wire bonding technology reduces thermal and mechanical stresses of the output chips resulting in a larger number of operational cycles compared to other assembly technologies.
- **Low machine downtime.** Integrated overvoltage protection prevents the solid state relay from breaking down due to uncontrolled transients that may occur on the lines.
- **Cost effective protection co-ordination.** The high I<sup>2</sup>t specification permits easy Type 2 protection co-ordination with B-type Minitaire Circuit Breakers.
- **Fast wiring.** Screw terminated power connections allow safe looping whilst box clamps terminals can handle easily cables up to 25 mm<sup>2</sup> / AWG3 cables. Spring loaded control terminals help reduce installation time.
- **Accommodates UL508A requirements for Industrial Control Panels.** All models carry a 100 kArms Short Circuit Current Rating.

### Description

This slimline range is an evolution of solid state switches for which Carlo Gavazzi is very well known. The RG series presents a unique opportunity for panel space savings thanks to the very slim footprint.

The **RGS** is only 17.5 mm wide with ratings up to 90 AAC. The output is protected against overvoltages by means of an integrated varistor. Control ON indication is provided through a green LED. Output connections are provided via a screw terminals having a captivated washer allowing for safe looping or via box clamp that can handle cables up to 25 mm<sup>2</sup> (AWG3). Input connection is provided either via screw terminals having a captivated washer or via a pluggable spring loaded terminal.

Options with integrated heatsink are available in the RGC range. The RGS..DIN provides an option for DIN mounting of the RGS series with a rating of 10 AAC @ 40°C.

Specifications are at a surrounding temperature of 25°C unless otherwise specified.

### Applications

Plastic injection machines, Extrusion machines, Blow moulding machines, Thermoformers, Dryers, Electrical ovens, Fryers, Shrink tunnels, Air handling units, Sterilisation equipment, Climatic chambers, Ovens and furnaces, Ambient heating.

### Main features

- Ratings up to 759 VAC, 90 A
- Up to 18000 A<sup>2</sup>s for I<sup>2</sup>t for protection coordination with M.C.Bs
- 100 kA short circuit current rating according to UL508
- Conformance to Railway standards

## Order code

 RGS1        E

Enter the code option instead of . Refer to the selection guide section for valid part numbers.

Code	Option	Description	Comments
R	-	Solid State Relay (RG)	
G	-		
S	-	Without heatsink	
1	-	1-pole switching	
<input type="checkbox"/>	A	Zero Cross switching (ZC)	
<input type="checkbox"/>	B	Instant ON switching (IO)	
<input type="checkbox"/>	23	Rated voltage: 24-264 VAC, 800 Vp	
<input type="checkbox"/>	60	Rated voltage: 42-660 VAC, 1200 or 1600 Vp	1600 Vp only for RGS..51,91
<input type="checkbox"/>	69	Rated voltage: 42-690 VAC, 1600 Vp	
<input type="checkbox"/>	D	Control voltage: 3-32 VDC	4-32 VDC for 600 / 690 VAC version
<input type="checkbox"/>	A	Control voltage: 20-275 VAC, 24-190 VDC	
<input type="checkbox"/>	25	Rated current: 25 AAC (525 A <sup>2</sup> s)	
<input type="checkbox"/>	50	Rated current: 50 AAC (1800 A <sup>2</sup> s)	
<input type="checkbox"/>	51	Rated current: 50 AAC (1800 A <sup>2</sup> s)	1600 Vp blocking voltage
<input type="checkbox"/>	75	Rated current: 75 AAC (3200 A <sup>2</sup> s)	
<input type="checkbox"/>	90	Rated current: 90 AAC (6600 A <sup>2</sup> s)	
<input type="checkbox"/>	91	Rated current: 90 AAC (6600 A <sup>2</sup> s)	1600 Vp blocking voltage
<input type="checkbox"/>	92	Rated current: 90 AAC (18000 A <sup>2</sup> s)	
<input type="checkbox"/>	K	Screw connection for control terminals	
<input type="checkbox"/>	M	Pluggable spring-loaded connection for control terminals	
<input type="checkbox"/>	K	Screw connection for power terminals	
<input type="checkbox"/>	G	Box clamp connection for power terminals	
E	-	Contact configuration	
<input type="checkbox"/>	-		No additional options
<input type="checkbox"/>	HT	Pre-attached thermal pad	Optional
<input type="checkbox"/>	X40	Bulk packaging of 40 pcs.	Optional
<input type="checkbox"/>	DIN	Pre-attached DIN accessory (RGS1DIN) for DIN rail mount	Optional, not available in bulk packaging

## Selection guide - RGS..

Rated voltage, Blocking voltage, Switching mode	Control voltage	Maximum rated operational current				
		25 AAC (525 A <sup>2</sup> s)	50 AAC (1800 A <sup>2</sup> s)	75 AAC (3200 A <sup>2</sup> s)	90 AAC (6600 A <sup>2</sup> s)	90 AAC (18000 A <sup>2</sup> s)
230 VAC, 800 Vp, ZC	3 - 32 VDC	RGS1A23D25KKE RGS1A23D25MKE	RGS1A23D50KKE RGS1A23D50MKE	- -	- -	- -
	20 - 275 VAC, 24 - 190 VDC	RGS1A23A25KKE RGS1A23A25MKE	RGS1A23A50KKE RGS1A23A50MKE	- -	- -	- -
600 VAC, 1200 Vp, ZC	4 - 32 VDC	RGS1A60D25KKE - RGS1A60D25MKE -	RGS1A60D50KKE RGS1A60D50KGE RGS1A60D50MKE RGS1A60D50MGE	RGS1A60D75KKE - -	RGS1A60D90KKE - RGS1A60D90MKE -	RGS1A60D92KKE RGS1A60D92KGE RGS1A60D92MKE RGS1A60D92MGE
	20 - 275 VAC, 24 - 190 VDC	RGS1A60A25KKE - RGS1A60A25MKE -	RGS1A60A50KKE RGS1A60A50KGE RGS1A60A50MKE -	RGS1A60A75KKE - -	RGS1A60A90KKE - RGS1A60A90MKE -	RGS1A60A92KKE RGS1A60A92KGE RGS1A60A92MKE -
600 VAC, 1600 Vp, ZC	4 - 32 VDC	-	RGS1A60D51KKE	-	RGS1A60D91KKE	-
	20 - 275 VAC, 24 - 190 VDC	-	RGS1A60A51KKE	-	RGS1A60A91KKE	-
690 VAC, 1600 Vp, ZC	4 - 32 VDC	-	-	-	RGS1A69D91KKE	-
	20 - 275 VAC, 24 - 190 VDC	-	-	-	RGS1A69A91KKE	-
600 VAC, 1200 Vp, IO	4 - 32 VDC	-	RGS1B60D50KKE	-	RGS1B60D90KKE	-

## Selection guide - RGS..HT (RGS with pre-attached Thermal Pad)<sup>1</sup>

Rated voltage, Blocking voltage, Switching mode	Control voltage	Maximum rated operational current		
		50 AAC (1800 A <sup>2</sup> s)	90 AAC (6600 A <sup>2</sup> s)	90 AAC (18000 A <sup>2</sup> s)
230 VAC, 800 Vp, ZC	3 - 32 VDC	RGS1A23D50KKEHT RGS1A23D50MKEHT	-	-
600 VAC, 1200 Vp, ZC	4 - 32 VDC	RGS1A60D50KKEHT RGS1A60D50KGEHT RGS1A60D50MKEHT RGS1A60D50MGEHT	RGS1A60D90KKEHT - RGS1A60D90MKEHT -	RGS1A60D92KKEHT RGS1A60D92KGEHT RGS1A60D92MKEHT RGS1A60D92MGEHT

1. The thermal pad with suffix 'HT' is available with any RGS part no. upon request. The above part numbers are some examples of available RGS with pre-attached thermal pad.

KKE:	input terminals = screw	output terminals = screw
KGE:	input terminals = screw	output terminals = box clamp
MKE:	input terminals = pluggable spring	output terminals = screw
MGE:	input terminals = pluggable spring	output terminals = box clamp

## Selection guide - RGS..DIN (RGS for DIN rail mounting)<sup>2</sup>

Rated voltage, Blocking voltage, Switching mode	Control voltage	Rated operational current		
		10 AAC (525 A <sup>2</sup> s)	12 AAC (1800 A <sup>2</sup> s)	12AAC (6600 A <sup>2</sup> s)
230 VAC, 1200 Vp ZC	3 - 32 VDC	RGS1A23D25KKEDIN	RGS1A23D50KKEDIN	-
	20 - 275 VAC, 24 - 190 VDC	RGS1A23A25KKEDIN	RGS1A23A50KKEDIN	-
600 VAC, 1200 Vp ZC	4 - 32 VDC	RGS1A60D25KKEDIN	RGS1A60D50KKEDIN	RGS1A60D90KKEDIN
	20 - 275 VAC, 24 - 190 VDC	RGS1A60A25KKEDIN	RGS1A60A50KKEDIN	-

2. Any of the available RGS part numbers can be factory mounted upon request to the RGS1DIN accessory. The above are some examples. Refer to 'Carlo Gavazzi compatible components' section for further details.

## Selection guide - RGS..X40 (RGS bulk packaging of 40 pcs.)

Rated voltage, Blocking voltage, Switching mode	Control voltage	Rated operational current		
		25 AAC (525 A <sup>2</sup> s)	50 AAC (1800 A <sup>2</sup> s)	75 AAC (3200A <sup>2</sup> s)
230 VAC, 800 Vp ZC	3 - 32 VDC	RGS1A23D25KKE X40	-	-
600 VAC, 1200 Vp ZC	4 - 32 VDC	-	RGS1A60D50KKE X40	RGS1A60D75KKE X40
	20 - 275 VAC, 24 - 190 VDC	RGS1A60A25KKE X40	-	-

KKE: input terminals = screw output terminals = screw

## Carlo Gavazzi compatible components

Description	Component code	Notes
Control plugs	RGM25	Pack of 10 spring loaded control plugs for RG
Screw kits	SRWKITM5X30MM	- RGS screw kit for mounting solid state relay to heatsink - Screw type: Torx T20, size M5 x 30 mm - Packing quantity: 20 pcs.
Thermal pads	RGHT	Pack of 10 RGS thermal pads with size 34.6 x 14mm
RGS DIN clip	RGS1DIN	DIN clip accessory for mounting RGS on DIN rail
Heatsinks	RHS	Heatsink and accessories

## Carlo Gavazzi further reading

Information	Where to find it	Notes
Datasheet	<a href="https://gavazziautomation.com/images/PIM/DATASHEET/ENG/rgc.pdf">https://gavazziautomation.com/images/PIM/DATASHEET/ENG/rgc.pdf</a>	Solid state contactor, RGC, 'E' - type configuration
Datasheet	<a href="https://gavazziautomation.com/images/PIM/DATASHEET/ENG/RGS_U.pdf">https://gavazziautomation.com/images/PIM/DATASHEET/ENG/RGS_U.pdf</a>	Solid state relay, RGS (without heatsink), 'U' - type configuration
Datasheet	<a href="https://gavazziautomation.com/images/PIM/DATASHEET/ENG/SSR_Accessories.pdf">https://gavazziautomation.com/images/PIM/DATASHEET/ENG/SSR_Accessories.pdf</a>	Solid state relay Accessories (including Heatsinks)
	<a href="https://gavazziautomation.com/nsc/hq/en/solid_state_relays">https://gavazziautomation.com/nsc/hq/en/solid_state_relays</a>	Online Heatsink selector tool

## Structure

RGS..KKE

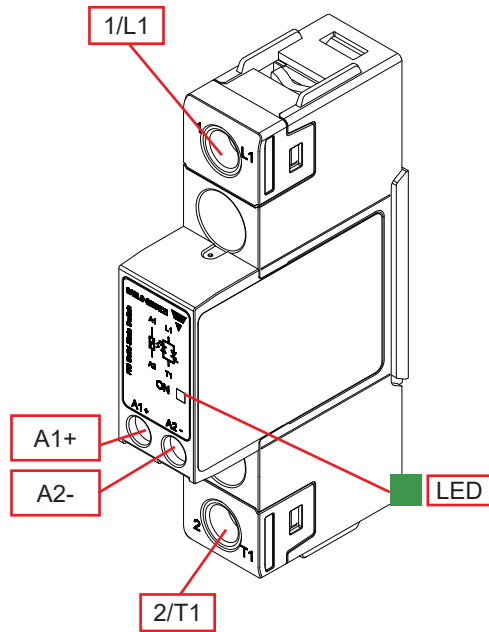

RGS..KGE

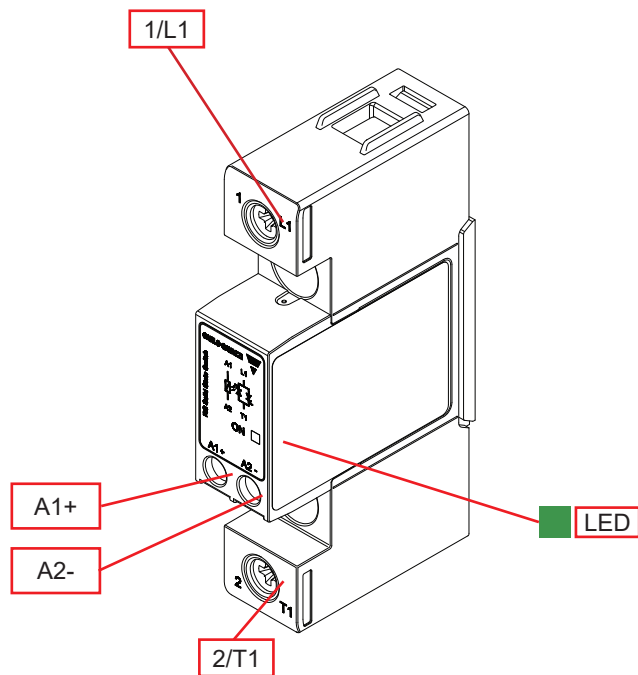

Element	Component	Function
1/L1	Power connection	Mains connection
2/T1	Power connection	Load connection
A1+, A2-	Control connection	Terminals for control voltage
LED	ON indicator	Indicates presence of control voltage

## Features

### General data

<b>Material</b>	PA66 or PA6 (UL94 V0), RAL7035 Glow wire ignition temperature and Glow wire flammability index conform to EN 60335-1 requirements	
<b>Mounting</b>	Panel mount	
<b>Touch Protection</b>	IP20	
<b>Overvoltage Category</b>	III, 6 kV (1.2/50 $\mu$ s) rated impulse withstand voltage	
<b>Isolation</b>	Input and Output to case Input to Output	4000 Vrms 4000 Vrms
<b>Weight</b>	RGS..: RGS..DIN:	approx. 103g approx. 155g

## Performance

### Output specifications

	RGS..25..	RGS..50/51..	RGS..75..	RGS..90/91..	RGS..92..
<b>Max. operational current<sup>3</sup>: AC-51</b>	25 AAC	50 AAC	75 AAC	90 AAC	90 AAC
<b>Max. operational current<sup>3</sup>: AC-53a</b>	5 AAC	10 AAC	14.8 AAC	18 AAC	18 AAC
<b>Operational frequency range</b>	45 to 65 Hz				
<b>Output protection</b>	Integrated varistor				
<b>Leakage current @ rated voltage</b>	<3 mAAC				
<b>Minimum operational current</b>	150 mAAC	250 mAAC	400 mAAC	400 mAAC	500 mAAC
<b>Repetitive overload current (Motor rating) UL508: Ta=40°C, t<sub>ON</sub>=1 s, t<sub>OFF</sub>=9 s, 50 cycles</b>	67 AAC	107 AAC	126 AAC	168 AAC	168 AAC
<b>Non-repetitive surge current (I<sub>TSM</sub>), t=10 ms</b>	325 Ap	600 Ap	800 Ap	1150 Ap	1900 Ap
<b>I<sup>2</sup>t for fusing (t=10 ms), minimum</b>	525 A <sup>2</sup> s	1800 A <sup>2</sup> s	3200 A <sup>2</sup> s	6600 A <sup>2</sup> s	18000 A <sup>2</sup> s
<b>No. of motor starts per hour<sup>3,4</sup> (x=6, Tx=6s, F=50%) @ 40°C</b>	30				
<b>Power factor</b>	>0.5 at rated voltage				
<b>Critical dV/dt (@T<sub>J</sub> init = 40°C)</b>	1000 V/ $\mu$ s				

3. Refer to Heatsink selection section

4. Overload profile for AC-53a: I<sub>e</sub>: AC-53a: x-Tx: F-S,

where I<sub>e</sub> = nominal current (AC-53a AAC), x = overload current factor, Tx = duration of overload current (s), F = duty cycle (%), S = number of starts per hour. Example; 5A: AC-53a: 6 - 6 : 50 - 30 = max. 30 starts for the RGS..25 with an overload profile of 30A for 6 seconds with a duty cycle of 50%

### Output specifications for RGS..DIN

	RGS..25..DIN	RGS..50..DIN	RGS..90..DIN
Max. operational current <sup>5</sup> : AC-51	10 AAC	12 AAC	12 AAC
Max. operational current: AC-53a	5 AAC	5 AAC	5 AAC
Operational frequency range	45 to 65 Hz		
Output protection	Integrated varistor		
Leakage current @ rated voltage	<3 mAAC		
Minimum operational current	150 mAAC	250 mAAC	400 mAAC
Non-repetitive surge current ( $I_{TSM}$ ), $t=10$ ms	325 Ap	600 Ap	1150 Ap
$I^2t$ for fusing ( $t=10$ ms), minimum	525 A <sup>2</sup> s	1800 A <sup>2</sup> s	6600 A <sup>2</sup> s
No. of motor starts per hour <sup>4</sup> ( $x=6$ , $T_x=6s$ , $F=50\%$ ) @ 40°C	30		
Power factor	>0.5 at rated voltage		
Critical dV/dt (@T <sub>j</sub> init = 40°C)	1000 V/μs		

5. Refer to Derating curves for RGS..DIN section

### Output voltage specifications

	RGS..23..	RGS..60..	RGS..69..
Operational voltage range	24-240 VAC, +10% -15% on max	42-600 VAC, +10% -15% on max	42-690 VAC <sup>6,7</sup> , +10% -15% on max
Blocking voltage	RGS..25/50/75/90/92	800 Vp	1200 Vp
	RGS..51/91	-	1600 Vp
Internal varistor	RGS..25/50/75/90/92	275 V	625V
	RGS..51/91	-	680V

6. 690 VAC refers to the line to line voltage

7. 690 VAC version is CE marked only and does not have an integrated varistor

### Motor ratings<sup>8</sup>: HP (UL508) / kW (EN/IEC 60947-4-2) @ 40°C

	115 VAC	230 VAC	400 VAC	480 VAC	600 VAC	690 VAC
RGS..25	½HP / 0.18kW	1½HP / 0.37kW	3HP / 0.75kW	3HP / 1.1kW	3HP / 1.5kW	- / 1.5kW
RGS..50/51	1HP / 0.37kW	3HP / 1.1kW	5HP / 1.5kW	5HP / 2.2kW	3HP / 1.5kW	- / 3.7kW
RGS..75	1½HP / 0.56kW	3HP / 1.5kW	5HP / 3kW	7½HP / 4kW	3HP / 1.5kW	- / 4kW
RGS..90/91/92	2HP / 0.75kW	5HP / 2.2kW	7½HP / 4kW	10HP / 5.5kW	5HP / 3.7kW	- / 5.5kW

8. Refer to Heatsink selection section

## Inputs

		RGS..D..	RGS..A..
Control voltage range <sup>9</sup>	RGS..23.. RGS..6x..	3 - 32 VDC 4 - 32 VDC	20-275 VAC, 24 (-10%) -190 VDC
Pick-up voltage	RGS..23.. RGS..6x..	3.0 VDC 3.8 VDC	20 VAC/DC
Drop-out voltage	RGS..23.. RGS..6x..	1.0 VDC	5 VAC/DC
Maximum reverse voltage		32 VDC	-
Maximum response time pick-up	RGS1A..	0.5 cycle + 500 $\mu$ s @ 24 VDC	2 cycles @ 230 VAC/110 VDC
Maximum response time pick-up	RGS1B..	350 $\mu$ s @ 24 VDC	-
Response time drop-out		0.5 cycle + 500 $\mu$ s @ 24 VDC	0.5 cycle + 40 ms @ 230 VAC/110 VDC
Input current @ 40°C		See diagrams below	

9. DC control to be supplied by class 2 power source according to UL1310

## Input current vs. input voltage

### RGS..D

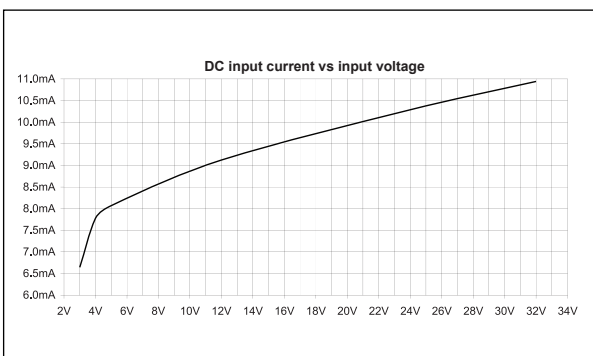

### RGS..A

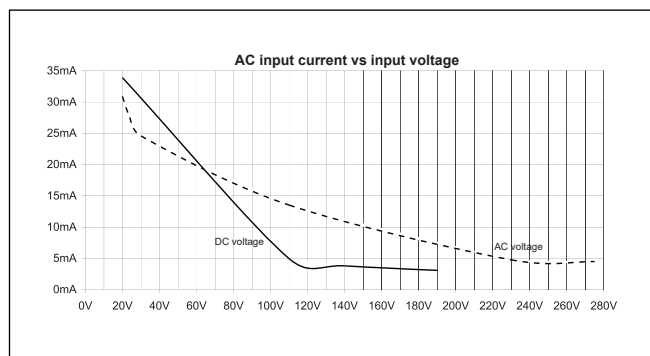

## Derating curves for RGS..DIN

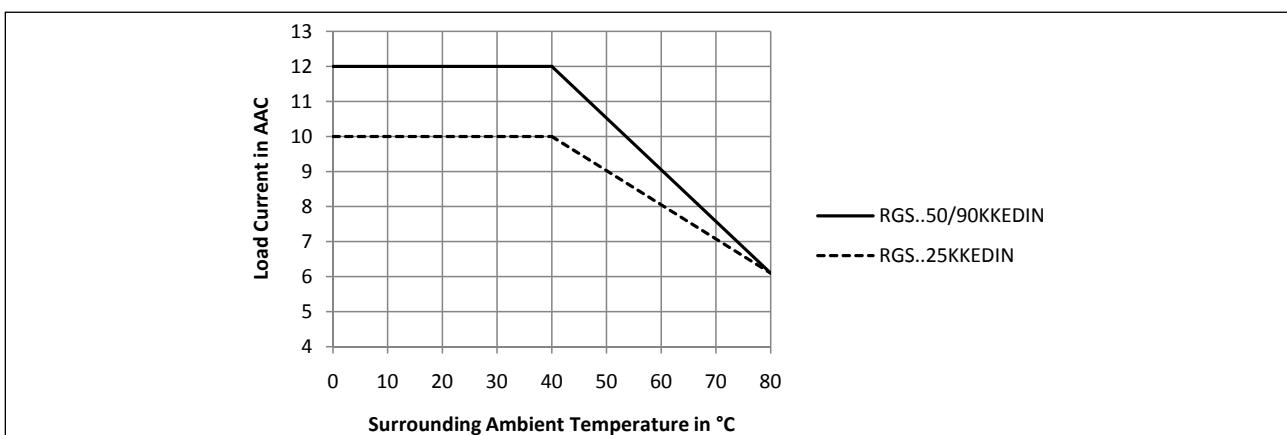



## Derating vs. spacing curves for RGS..DIN

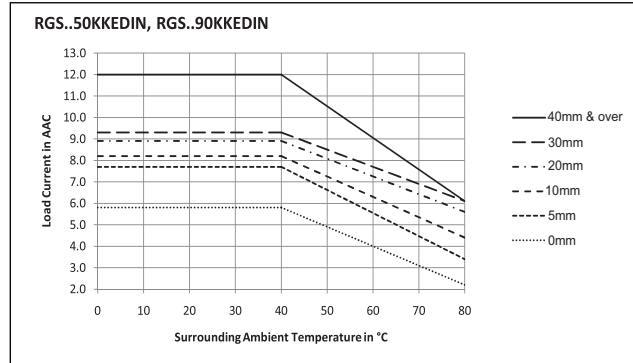
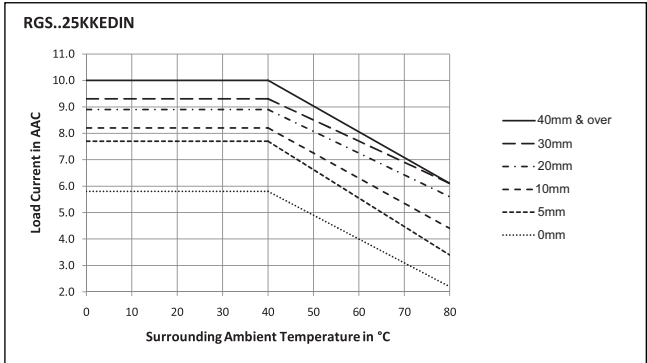

## Output power dissipation

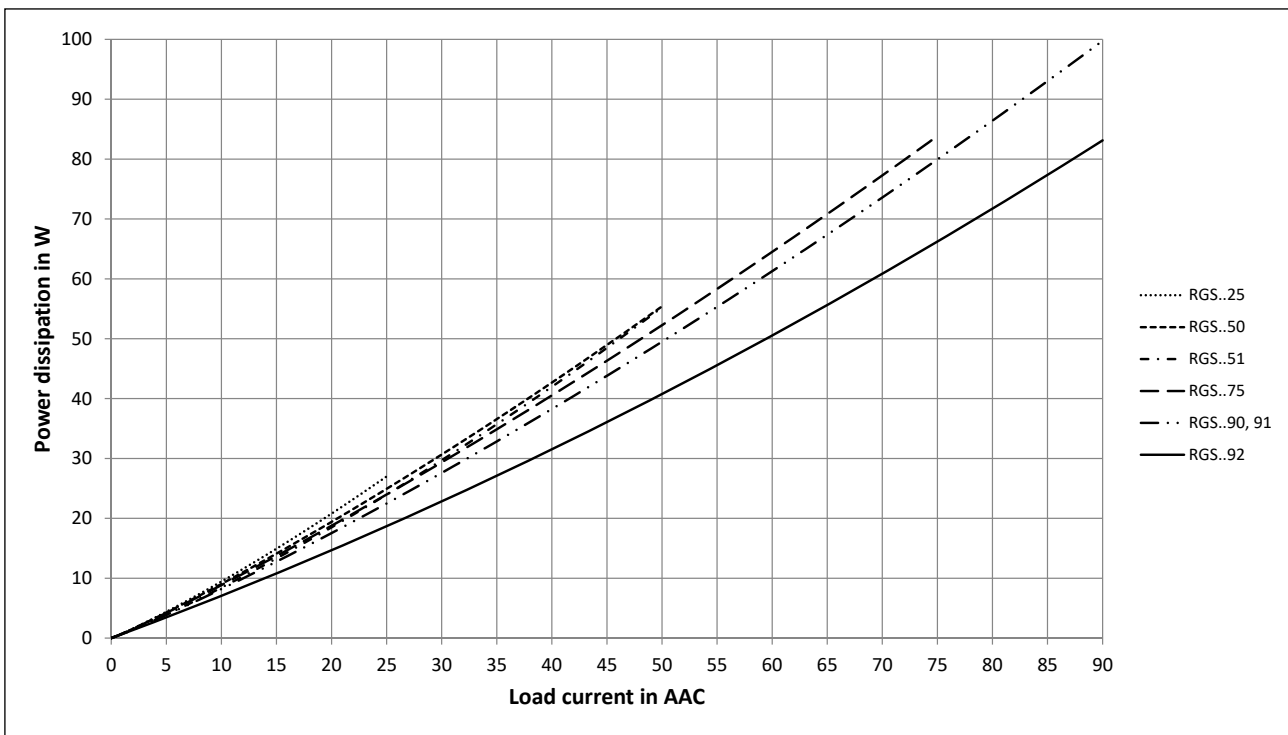

## Heatsink selection for RGS...

Thermal resistance [°C/W] of RGS1..25

Load current [A]	Surrounding ambient temperature [°C]						
	20	30	40	50	60	70	80
25.0	3.11	2.72	2.33	1.94	1.55	1.17	0.78
22.5	3.55	3.10	2.66	2.22	1.77	1.33	0.89
20.0	4.10	3.59	3.08	2.56	2.05	1.54	1.03
17.5	4.83	4.23	3.63	3.02	2.42	1.81	1.21
15.0	5.83	5.10	4.37	3.64	2.91	2.18	1.46
12.5	7.24	6.34	5.43	4.53	3.62	2.72	1.81
10.0	9.43	8.25	7.07	5.89	4.71	3.54	2.36
7.5	13.17	11.53	9.88	8.23	6.59	4.94	3.29
5.0	nh	nh	nh	13.11	10.49	7.86	5.24
2.5	nh	nh	nh	nh	nh	nh	11.47

Thermal resistance [°C/W] of RGS1..5x

Load current [A]	Surrounding ambient temperature [°C]						
	20	30	40	50	60	70	80
50.0	1.45	1.28	1.06	0.87	0.68	0.49	0.30
45.0	1.72	1.50	1.29	1.07	0.85	0.64	0.42
40.0	2.00	1.75	1.50	1.25	1.00	0.75	0.50
35.0	2.35	2.06	1.76	1.47	1.18	0.88	0.59
30.0	2.83	2.48	2.13	1.77	1.42	1.06	0.71
25.0	3.52	3.08	2.64	2.20	1.76	1.32	0.88
20.0	4.58	4.01	3.44	2.86	2.29	1.72	1.15
15.0	6.40	5.60	4.80	4.00	3.20	2.40	1.60
10.0	10.19	8.92	7.64	6.37	5.10	3.82	2.55
5.0	nh	nh	nh	13.94	11.15	8.36	5.57

Thermal resistance [°C/W] of RGS1..75

Load current [A]	Surrounding ambient temperature [°C]						
	20	30	40	50	60	70	80
75.0	0.80	0.68	0.55	0.43	0.30	0.18	0.06
67.5	0.99	0.84	0.70	0.56	0.42	0.28	0.14
60.0	1.22	1.06	0.89	0.73	0.56	0.40	0.24
52.5	1.53	1.33	1.14	0.95	0.76	0.56	0.37
45.0	1.86	1.63	1.40	1.16	0.93	0.7	0.47
37.5	2.32	2.03	1.74	1.45	1.16	0.87	0.58
30.0	3.01	2.64	2.26	1.88	1.51	1.13	0.75
22.5	4.21	3.68	3.16	2.63	2.10	1.58	1.05
15.0	6.68	5.85	5.01	4.18	3.34	2.51	1.67
7.5	nh	12.71	10.89	9.08	7.26	5.45	3.63

Thermal resistance [°C/W] of RGS1..9x

Load current [A]	Surrounding ambient temperature [°C]						
	20	30	40	50	60	70	80
90.0	0.62	0.52	0.41	0.31	0.21	0.11	0.01
81.0	0.77	0.66	0.54	0.42	0.31	0.19	0.07
72.0	0.97	0.83	0.70	0.56	0.43	0.29	0.16
63.0	1.23	1.07	0.91	0.75	0.59	0.43	0.27
54.0	1.55	1.35	1.16	0.97	0.77	0.58	0.39
45.0	1.93	1.69	1.45	1.21	0.97	0.73	0.48
36.0	2.53	2.21	1.89	1.58	1.26	0.95	0.63
27.0	3.55	3.11	2.66	2.22	1.77	1.33	0.89
18.0	5.67	4.97	4.26	3.55	2.84	2.13	1.42
9.0	nh	10.90	9.34	7.79	6.23	4.67	3.11

'nh' means no heatsink necessary. The SSR should still be tightened to a surface to ensure optimal thermal dissipation

## Heatsink selection for RGS...HT

Thermal resistance [°C/W] of RGS1..25..HT

Load current [A]	Surrounding ambient temperature [°C]						
	20	30	40	50	60	70	80
25.0	2.73	2.34	1.95	1.56	1.18	0.79	0.40
22.5	3.30	2.86	2.42	1.97	1.53	1.09	0.64
20.0	4.04	3.52	3.01	2.50	1.98	1.47	0.96
17.5	4.83	4.23	3.63	3.02	2.42	1.81	1.21
15.0	5.83	5.10	4.37	3.64	2.91	2.18	1.46
12.5	7.24	6.34	5.43	4.53	3.62	2.72	1.81
10.0	9.43	8.25	7.07	5.89	4.71	3.54	2.36
7.5	13.17	11.53	9.88	8.23	6.59	4.94	3.29
5.0	nh	nh	nh	13.11	10.49	7.86	5.24
2.5	nh	nh	nh	nh	nh	nh	11.47

Thermal resistance [°C/W] of RGS1..5x..HT

Load current [A]	Surrounding ambient temperature [°C]						
	20	30	40	50	60	70	80
50.0	0.84	0.65	0.46	0.27	0.08	-	-
45.0	1.12	0.90	0.69	0.47	0.25	0.04	-
40.0	1.47	1.22	0.97	0.72	0.47	0.22	-
35.0	1.94	1.64	1.35	1.06	0.76	0.47	0.17
30.0	2.57	2.22	1.86	1.51	1.15	0.80	0.44
25.0	3.48	3.03	2.59	2.15	1.71	1.27	0.83
20.0	4.58	4.01	3.44	2.86	2.29	1.72	1.15
15.0	6.40	5.60	4.80	4.00	3.20	2.40	1.60
10.0	10.19	8.92	7.64	6.37	5.10	3.82	2.55
5.0	nh	nh	nh	13.94	11.15	8.36	5.57

Thermal resistance [°C/W] of RGS1..75..HT

Load current [A]	Surrounding ambient temperature [°C]						
	20	30	40	50	60	70	80
75.0	0.25	0.13	0.00	-	-	-	-
67.5	0.44	0.29	0.15	0.01	-	-	-
60.0	0.67	0.51	0.34	0.18	0.01	-	-
52.5	0.98	0.78	0.59	0.40	0.21	0.01	-
45.0	1.39	1.16	0.93	0.70	0.46	0.23	-
37.5	1.99	1.70	1.41	1.12	0.83	0.54	0.25
30.0	2.91	2.53	2.15	1.78	1.40	1.02	0.65
22.5	4.21	3.68	3.16	2.63	2.10	1.58	1.05
15.0	6.68	5.85	5.01	4.18	3.34	2.51	1.67
7.5	14.53	12.71	10.89	9.08	7.26	5.45	3.63

Thermal resistance [°C/W] of RGS1..9x..HT

Load current [A]	Surrounding ambient temperature [°C]						
	20	30	40	50	60	70	80
90.0	0.07	-	-	-	-	-	-
81.0	0.22	0.11	-	-	-	-	-
72.0	0.42	0.28	0.15	0.01	-	-	-
63.0	0.68	0.52	0.36	0.2	0.04	-	-
54.0	1.03	0.84	0.65	0.45	0.26	0.06	-
45.0	1.54	1.30	1.05	0.81	0.57	0.33	0.09
36.0	2.32	2.00	1.69	1.37	1.05	0.74	0.42
27.0	3.55	3.11	2.66	2.22	1.77	1.33	0.89
18.0	5.67	4.97	4.26	3.55	2.84	2.13	1.42
9.0	12.46	10.90	9.34	7.79	6.23	4.67	3.11









## Thermal data

	RGS..25..	RGS..5x..	RGS..75..	RGS..9x..
Max. junction temperature	125°C	125°C	125°C	125°C
Junction to case thermal resistance, $R_{thjc}$	<0.45°C/W	<0.3°C/W	<0.25°C/W	<0.20°C/W
Case to heatsink thermal resistance, $R_{thcs}^{10}$	<0.25°C/W	<0.25°C/W	<0.25°C/W	<0.25°C/W
Case to heatsink thermal resistance (RGS..HT), $R_{thcs-HT}^{11}$	<0.9°C/W	<0.85°C/W	<0.8°C/W	<0.8°C/W

10. Thermal resistance case to heatsink values are applicable upon application of a fine layer of silicon based thermal paste HTS02S from Electrolube between SSR and heatsink.

11. Thermal resistance case to heatsink values for RGS..HT are applicable for the RGHT thermal pad.

### Compatibility and conformance

<b>Approvals</b>	       <sup>12</sup> 
<b>Standards compliance</b>	LVD: EN/IEC 60947-4-2, EN/IEC 60947-4-3 EMCD: EN/IEC 60947-4-3 EE: EN 60947-4-3 EMC: EN 60947-4-3 cURus: UL508 Recognised (E172877), NMFT2, NMFT8 CSA: C22.2 No.14, (204075) VDE: VDE0660-109
<b>UL short circuit current rating</b>	100k Arms (refer to short circuit current section, Type 1 – UL508)

12. Applicable only for RGS..50 models

Electromagnetic compatibility (EMC) - Immunity	
<b>Electrostatic discharge (ESD)</b>	EN/IEC 61000-4-2 8 kV air discharge, 4 kV contact (PC1)
<b>Radiated radio frequency</b>	EN/IEC 61000-4-3 10 V/m, from 80 MHz to 1 GHz (PC1) 10 V/m, from 1.4 to 2 GHz (PC1) 10 V/m, from 2 to 2.7 GHz (PC1)
<b>Electrical fast transient (burst)</b>	EN/IEC 61000-4-4 Output: 2 kV, 5 kHz (PC1) Input: 1 kV, 5 kHz (PC1)
<b>Conducted radio frequency</b>	EN/IEC 61000-4-6 10 V/m, from 0.15 to 80 MHz (PC1)
<b>Electrical surge<sup>13</sup></b>	EN/IEC 61000-4-5 Output, line to line: 1 kV (PC1) Output, line to earth: 2 kV (PC1) Input, line to line, 1kV (PC2) Input, line to earth, 2kV (PC2)
<b>Voltage dips</b>	EN/IEC 61000-4-11 0% for 0.5, 1 cycle (PC2) 40% for 10 cycles (PC2) 70% for 25 cycles (PC2) 80% for 250 cycles (PC2)
<b>Voltage interruptions</b>	EN/IEC 61000-4-11 0% for 5000 ms (PC2)

13. An external varistor, S20K750, needs to be connected across the mains supply for the RGS1A69.. models

Electromagnetic compatibility (EMC) - Emissions	
<b>Radio interference field emission (radiated)</b>	EN/IEC 55011 Class A: from 30 to 1000 MHz
<b>Radio interference voltage emissions (conducted)</b>	EN/IEC 55011 Class A: from 0.15 to 30 MHz (External filter may be required - refer to Filtering section)



**Additional conformance to railway standards**

<b>Applicable to variants</b>	RGS..
<b>Additional conformance specific to railway applications</b>	EN 50155 EN 45545-2 EN 50121-3-2
<b>Hazardous level conformance according to EN 45545-2</b>	HL1, HL2 for requirement R23 HL1 for requirement R22
<b>Operating temperature class according to EN 50155</b>	OT3 (-25 °C to +70 °C )
<b>Vibration and shock</b>	EN 61373 Category 1, Class B
<b>Additional EMC conformance</b>	according to EN 50121-3-2
<b>Radiated radio frequency immunity</b>	EN/IEC 61000-4-3 20 V/m, from 80 MHz to 1 GHz (PC1) 10 V/m, from 1.4 to 2 GHz (PC1) 5 V/m, from 2 to 2.7 GHz (PC1) 3V/m, 5.1 - 6 GHz (PC1)
<b>Power quality measurement</b>	EN/IEC 61000-4-30 50 Hz - 2 kHz, <8% THD (PASS)

## Note:

- Control input lines must be installed together to maintain products' susceptibility to Radio Frequency interference.
- Use of AC solid state relays may, according to the application and the load current, cause conducted radio interferences. Use of mains filters may be necessary for cases where the user must meet E.M.C requirements. The capacitor values given inside the filtering specification tables should be taken only as indications, the filter attenuation will depend on the final application.
- This product has been designed for Class A equipment. Use of this product in domestic environments may cause radio interference, in which case the user may be required to employ additional mitigation methods.
- Performance Criteria 1 (PC1): No degradation of performance or loss of function is allowed when the product is operated as intended.
- Performance Criteria 2 (PC2): During the test, degradation of performance or partial loss of function is allowed. However when the test is complete the product should return operating as intended by itself.
- Performance Criteria 3 (PC3): Temporary loss of function is allowed, provided the function can be restored by manual operation of the controls.

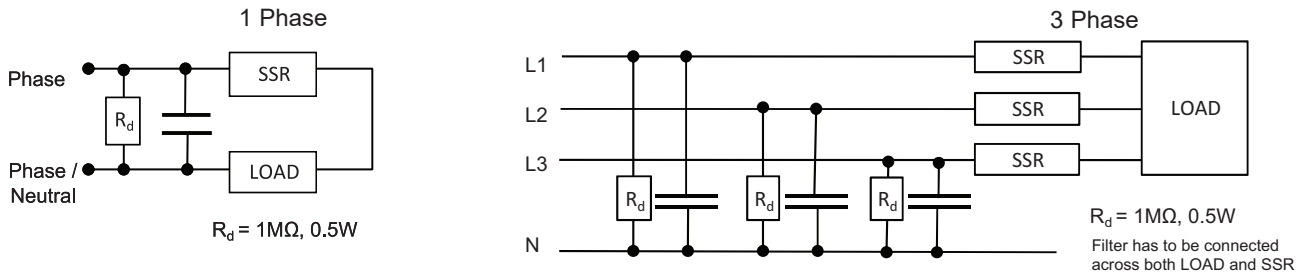
**Filter connection diagram**



**Filtering**

Part number	Suggested filter for EN 55011 Class A compliance	Maximum heater current
RGS1.23..25	100nF / 275 V / X1	25 AAC
RGS1.23..50	220nF / 275 V / X1 330nF / 275 V / X1	30 AAC 35 AAC
RGS1.60..25	150 nF / 760V / X1	25 AAC
RGS1.60..50	330 nF / 760V / X1	30 AAC
RGS1.60..51	220 nF / 760V / X1	30 AAC
RGS1.60..75	220 nF / 760V / X1 330 nF / 760V / X1	30 AAC 45 AAC
RGS1.60..90/91/92	220 nF / 760V / X1 330 nF / 760V / X1 680 nF / 760V / X1	30 AAC 45 AAC 65 AAC

## Environmental specifications

<b>Operating temperature</b>	-40°C to +80°C (-40°F to +176°F)
<b>Storage temperature</b>	-40°C to +100°C (-40°F to +212 °F)
<b>Relative humidity</b>	95% non-condensing @ 40°C
<b>Pollution degree</b>	2
<b>Installation altitude</b>	0-1000 m. Above 1000 m derate linearly by 1% of FLC per 100 m up to a maximum of 2000 m
<b>Vibration resistance</b>	5g / axis (2-100Hz, IEC 60068-2-6, EN 50155, EN 61373)
<b>Impact resistance</b>	15/11 g/ms (EN 50155, EN 61373)
<b>EU RoHS compliant</b>	Yes
<b>China RoHS</b>	

The declaration in this section is prepared in compliance with People's Republic of China Electronic Industry Standard SJ/T11364-2014: Marking for the Restricted Use of Hazardous Substances in Electronic and Electrical Products.

Part Name	Toxic or Harardous Substances and Elements					
	Lead (Pb)	Mercury (Hg)	Cadmium (Cd)	Hexavalent Chromium (Cr(VI))	Polybrominated biphenyls (PBB)	Polybrominated diphenyl ethers (PBDE)
<b>Power Unit Assembly</b>	x	○	○	○	○	○

O: Indicates that said hazardous substance contained in homogeneous materials for this part are below the limit requirement of GB/T 26572.

X: Indicates that said hazardous substance contained in one of the homogeneous materials used for this part is above the limit requirement of GB/T 26572.

这份申明根据中华人民共和国电子工业标准 SJ/T11364-2014：标注在电子电气产品中限定使用的有害物质

零件名称	有毒或有害物质与元素					
	铅 (Pb)	汞 (Hg)	镉 (Cd)	六价铬 (Cr(VI))	多溴化联苯 (PBB)	多溴联苯醚 (PBDE)
功率单元	x	○	○	○	○	○

O:此零件所有材料中含有的该有害物低于GB/T 26572的限定。

X: 此零件某种材料中含有的该有害物高于GB/T 26572的限定。

**Short circuit protection**

**Protection Co-ordination, Type 1 vs Type 2:**

Type 1 protection implies that after a short circuit, the device under test will no longer be in a functioning state. In Type 2 co-ordination the device under test will still be functional after the short circuit. In both cases, however the short circuit has to be interrupted. The fuse between enclosure and supply shall not open. The door or cover of the enclosure shall not be blown open. There shall be no damage to conductors or terminals and the conductors shall not separate from terminals. there shall be no breakage or cracking of insulating bases to the extent that the integrity of the mounting of live parts is impaired. Discharge of parts or any risk of fire shall not occur.

The product variants listed in the table hereunder are suitable for use on a circuit capable of delivering not more than 100,000 Arms Symmetrical Amperes, 600 Volts maximum when protected by fuses. Tests at 100,000 A were performed with Class J fuses, fast acting; please refer to the table below for maximum allowed ampere rating of the fuse. Use fuses only.

Tests with Class J fuses are representative of Class CC fuses.

Protection co-ordination Type 1 according to UL 508				
Part No.	Prospective short circuit current [kArms]	Max fuse size [A]	Class	Voltage [VAC]
RGS..25	100	30	J or CC	Max. 600
RGS..50		30	J or CC	
RGS..51		30	J or CC	
RGS..75		30	J or CC	
RGS..90 / 91		30	J or CC	
RGS..92		80	J	

Protection co-ordination Type 2 (IEC/EN 60947-4-2/ -4-3)						
Part No.	Prospective short circuit current [kArms]	Ferraz Shawmut (Mersen)		Siba		Max. voltage [VAC]
		Max fuse size [A]	Part number	Max fuse size [A]	Part number	
RGS..25	10	40	6.6xx CP URD 22x58 /40	32	50 142 06.32	660
	100					
RGS..50	10	80	6.621 CP URQ 27x60 /80	50	50 142 06.50	660
		70	A70QS70-4			
	100	80	6.621 CP URQ 27x60 /80			
		70	A70QS70-4			
RGS..51	10	80	6.621 CP URQ 27x60 /80	-	-	660
		70	A70QS70-4			
	100	80	6.621 CP URQ 27x60 /80			
		70	A70QS70-4			
RGS..75	10	100	6.621 CP URQ 27x60 /100	80	50 194 20.80	660
	100		A70QS100-4			
RGS..90/91	10	125	6.621 CP URQ 27x60 /125	100	50 194 20.100	660
	100		A70QS125-4			
RGS..92	10	125	6.621 CP URD 22x58 /125	125	50 194 20.125	660
	100		A70QS125-4			
RGS1A69..91	100	-	-	100	50 197 20.100	759





Protection co-ordination Type 2 with Miniature Circuit Breakers (M.C.B.s)				
Solid State Relay type	ABB Model no. for Z - type M. C. B. (rated current)	ABB Model no. for B - type M. C. B. (rated current)	Wire cross sectional area [mm <sup>2</sup> ]	Minimum length of Cu wire conductor [m] <sup>14</sup>
RGS..25 (525 A <sup>2</sup> s)	S201 - Z4 (4A)	S201 - B2 (2A)	1.0	21.0
	S201 - Z6 UC (6A)	S201 - B2 (2A)	1.0	21.0
			1.5	31.5
RGS..50 RGS..51 (1800 A <sup>2</sup> s)	S201 - Z10 (10A)	S201-B4 (4A)	1.0	7.6
			1.5	11.4
			2.5	19.0
	S201 - Z16 (16A)	S201-B6 (6A)	1.0	5.2
			1.5	7.8
			2.5	13.0
			4.0	20.8
	S201 - Z20 (20A)	S201-B10 (10A)	1.5	12.6
			2.5	21.0
	S201 - Z25 (25A)	S201-B13 (13A)	2.5	25.0
4.0			40.0	
S202 - Z25 (25A)	S202-B13 (13A)	2.5	19.0	
		4.0	30.4	
RGS..75 (3200 A <sup>2</sup> s)	S201 - Z25 (25A)	S201 - B13 (13A)	2.5	7.0
			4.0	11.2
			6.0	16.8
RGS..90 RGS..91 (6600 A <sup>2</sup> s)	S201 - Z20 (20A)	S201-B10 (10A)	1.5	4.2
			2.5	7.0
			4.0	11.2
	S201 - Z32 (32A)	S201-B16 (16A)	2.5	13.0
			4.0	20.8
			6.0	31.2
	S202 - Z20 (20A)	S202-B10 (10A)	1.5	1.8
			2.5	3.0
			4.0	4.8
	S202 - Z32 (32A)	S202-B16 (16A)	2.5	5.0
4.0			8.0	
6.0			12.0	
10.0			20.0	
S202 - Z50 (50A)	S202-B25 (25A)	4.0	14.8	
		6.0	22.2	
		10.0	37.0	
RGS..92 (18000 A <sup>2</sup> s)	S201-Z32 (32A)	S201-B16 (16A)	2.5	3.0
			4.0	4.8
			6.0	7.2
	S201-Z50 (50A)	S201-B25 (25A)	4.0	4.8
			6.0	7.2
			10.0	12.0
			16.0	19.2
	S201-Z63 (63A)	S201-B32 (32A)	6.0	7.2
			10.0	12.0
			16.0	19.2

14. Between MCB and Load (including return path which goes back to the mains)

Note: A prospective current of 6 kA and a 230 / 400 V power supply is assumed for the above suggested specifications. For cables with different cross section than those mentioned above please consult Carlo Gavazzi's Technical Support Group.

S201 models refer to 1-pole M.C.B., S202 models refer to 2-poles M.C.B.

## Dimensions - RGS

### RGS...KKE

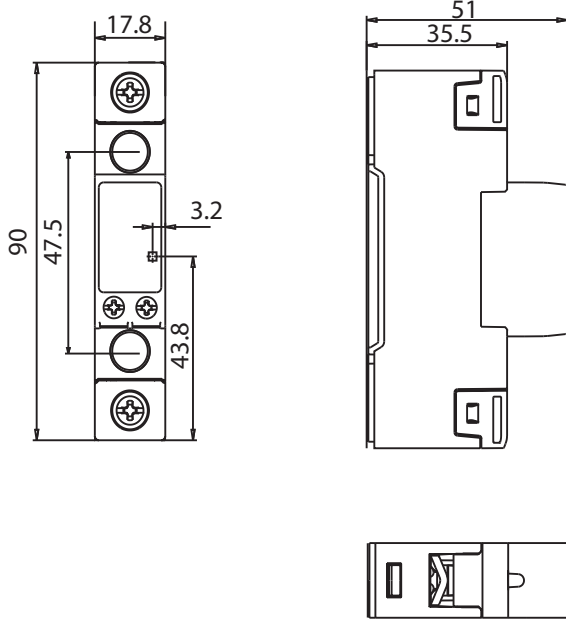

### RGS...MKE

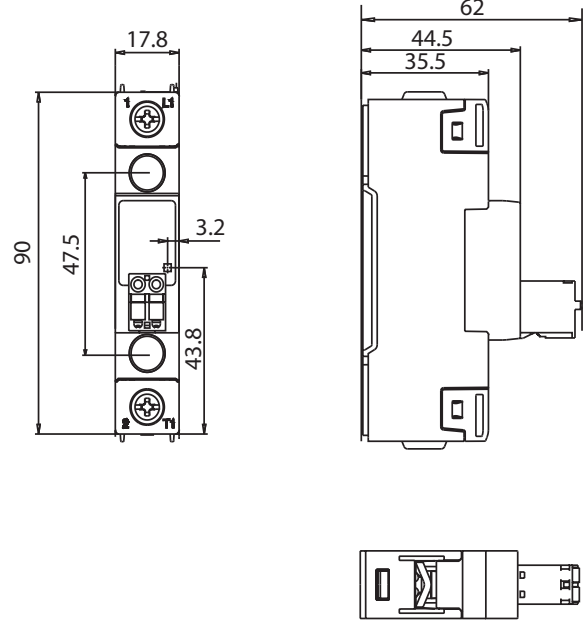

### RGS...KGE

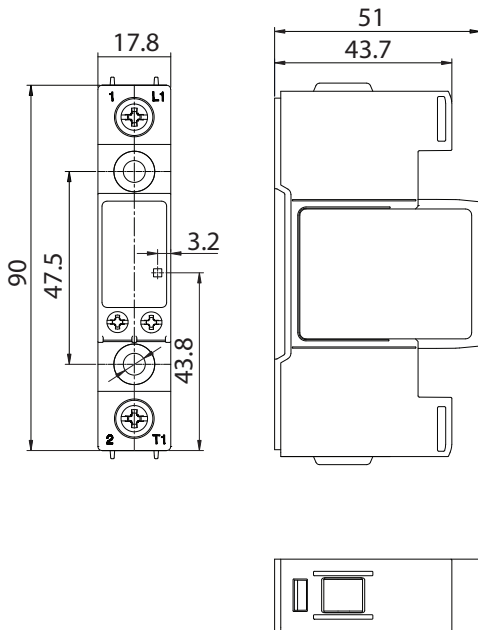

### RGS...MGE

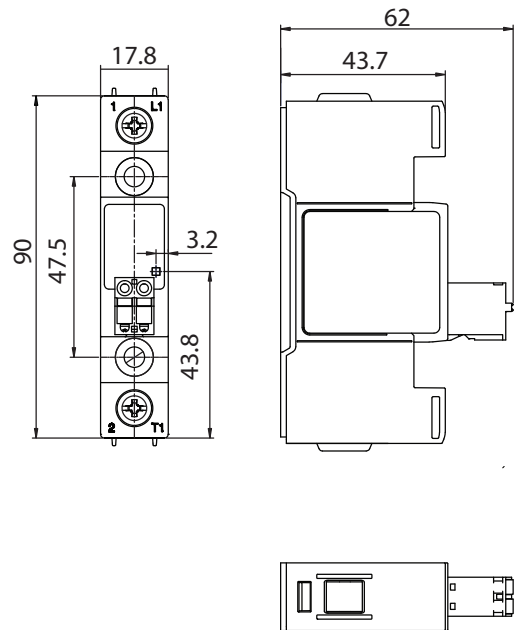

Housing width tolerance +0.5mm, -0mm as per DIN 43880. All other tolerances +/- 0.5mm.  
Dimensions in mm.

## Dimensions - RGS..DIN

### RGS...KKEDIN

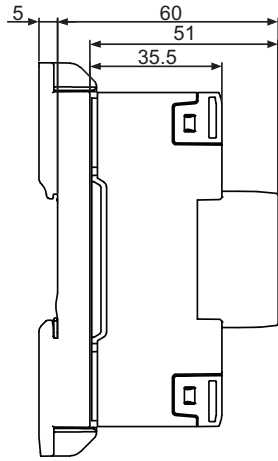
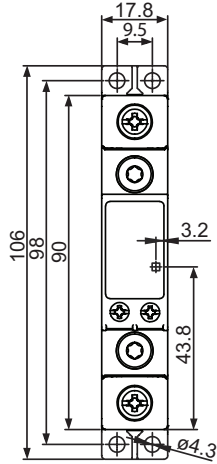

### RGS...MKEDIN

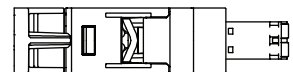
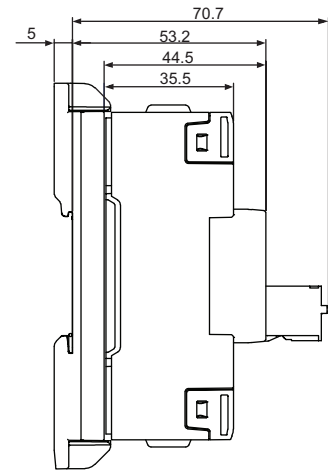
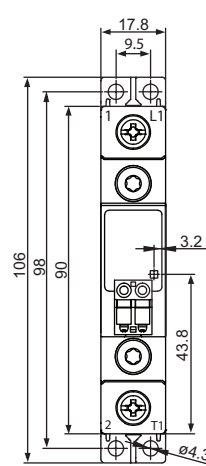

Housing width tolerance +0.5mm, -0mm as per DIN 43880. All other tolerances +/- 0.5mm. Dimensions in mm.

## Terminal layout

### RGS...KKE

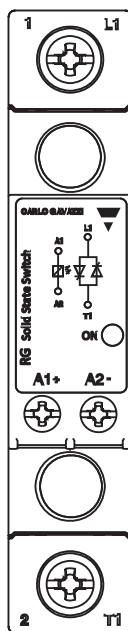

### RGS...MKE

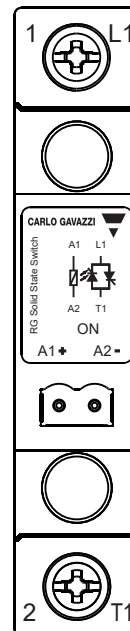

- 1/L1: Mains supply connection
- 2/T1: Load connection
- A1 (+): Positive control signal
- A2 (-): Control ground

# Connection Diagram

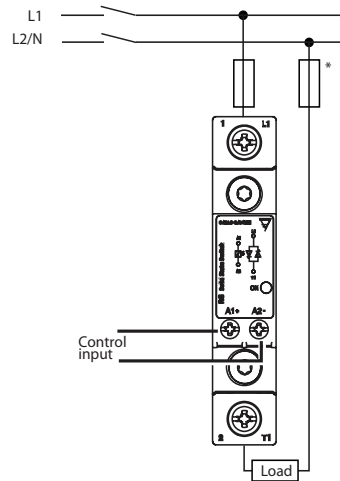

\* depends on system requirements

## Functional diagram

### DC control

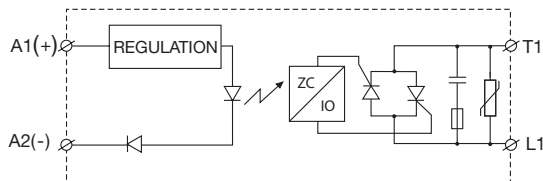

### AC control

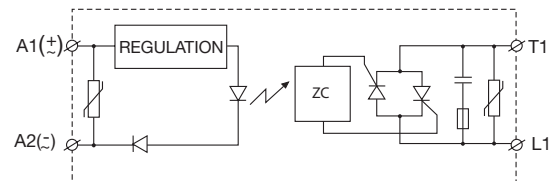

Note: Varistor on output is not included in the RGS1A69... models

## RGS to heatsink mounting instructions

Thermal stress will reduce the lifetime of the SSR. Therefore it is necessary to select the appropriate heatsinks, taking into account the surrounding temperature, load current and the duty cycle. A fine layer of thermally conductive silicone paste must be evenly applied to the back of the SSR. RGS should be mounted on the heatsink with two M5 x 30mm screws (**SRWKITM5X30MM**). Each screw shall be gradually tightened (alternating between the two) until both are tightened with a torque of 0.75 Nm. Both screws are the tightened to their final mounting torque of 1.5 Nm.

In case of a thermal pad attached to the back of the SSR, no thermal paste is required. The RGS is gradually tightened (alternating between the 2 screws) to a maximum torque of 1.5 Nm.

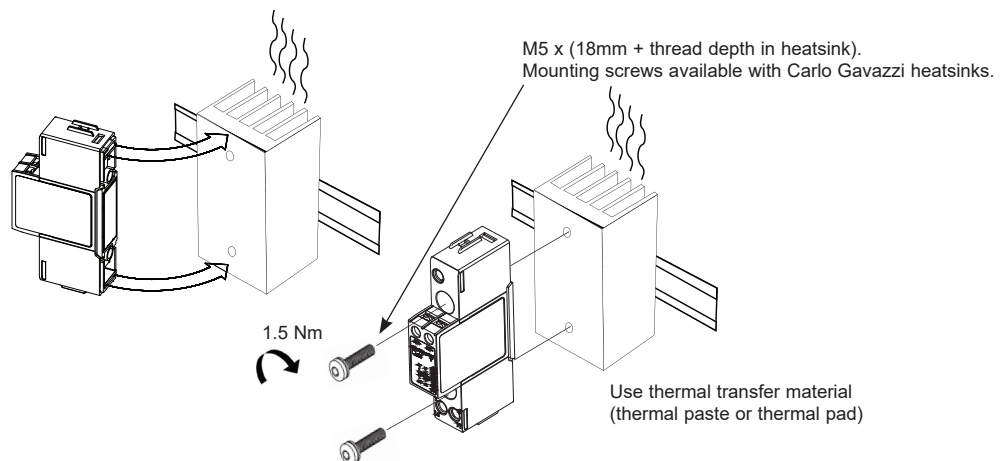

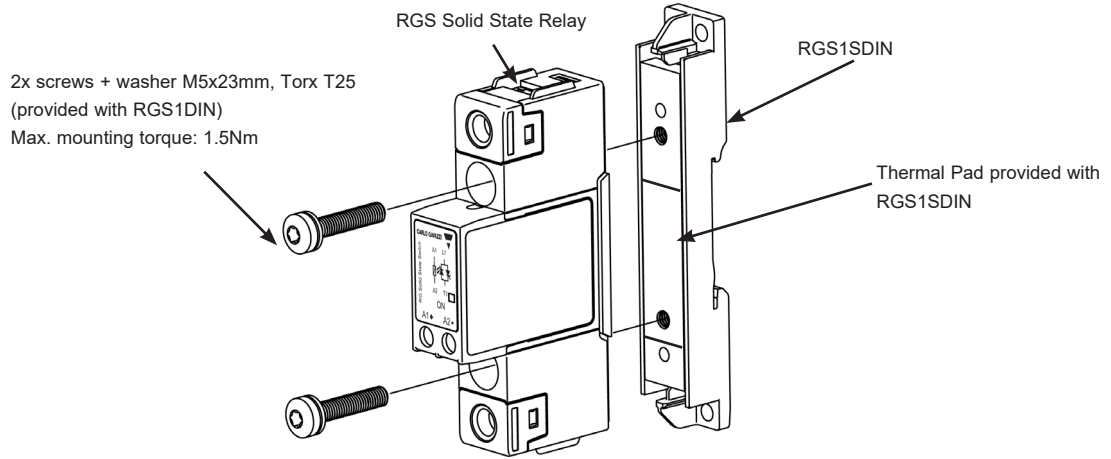

## RGS to RGS1DIN mounting instructions



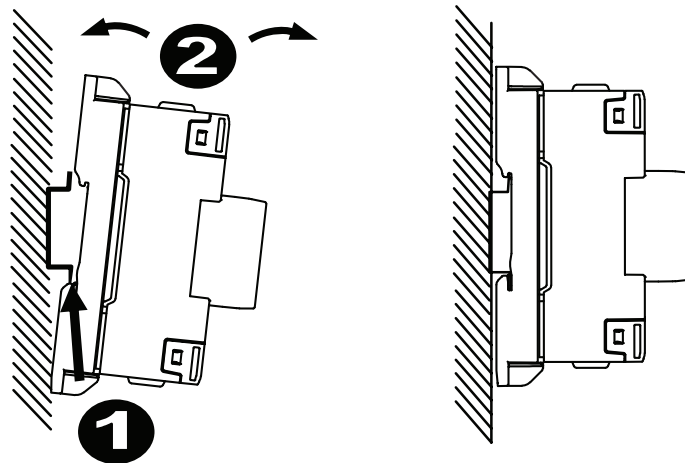

## RGS..DIN installation instructions



## Connection Specifications

Power connections			
Terminals	1/L1, 2/T1		
Conductors	Use 75°C copper (Cu) conductors		
	RGS..KKE, RGS..MKE		RGS..KGE, RGS..MGE
			
Connection type	M4 screw with captivated washer		M5 screw with box clamp
Stripping length	12 mm		11 mm
Rigid (solid & stranded) UL/CSA rated data	2x 2.5 – 6.0 mm <sup>2</sup> 2x 14 – 10 AWG	1x 2.5 – 6.0 mm <sup>2</sup> 1x 14 – 10 AWG	1x 2.5 – 25.0 mm <sup>2</sup> 1x 14 – 3 AWG
Flexible with end sleeve	2x 1.0 – 2.5 mm <sup>2</sup> 2x 2.5 – 4.0 mm <sup>2</sup> 2x 18 – 14 AWG 2x 14 – 12 AWG	1x 1.0 – 4.0 mm <sup>2</sup> 1x 18 – 12 AWG	1x 2.5 – 16.0 mm <sup>2</sup> 1x 14 – 6 AWG
Flexible without end sleeve	2x 1.0 – 2.5 mm <sup>2</sup> 2x 2.5 – 6.0 mm <sup>2</sup> 2x 18 – 14 AWG 2x 14 – 10 AWG	1x 1.0 – 6.0 mm <sup>2</sup> 1x 18 – 10 AWG	1x 4.0 – 25.0 mm <sup>2</sup> 1x 12 – 3 AWG
Torque specifications	Posidrive bit 2 UL: 2.0 Nm (17.7 lb-in) IEC: 1.5 – 2.0 Nm (13.3 – 17.7 lb-in)		Posidrive bit 2 UL: 2.5 Nm (22 lb-in) IEC: 2.5 – 3.0 Nm (22 – 26.6 lb-in)
Aperture for termination lug (fork or ring)	12.3 mm		n/a

Control connections			
Terminals	A1+, A2-		
Conductors	Use 60/75°C copper (Cu) conductors		
	RGS..KKE, RGS..KGE screw control terminal		RGS..MKE spring plug control terminal
			
Connection type	M3 screw with captivated washer		Spring loaded
Stripping length	8 mm		12-13 mm
Rigid (solid & stranded) UL/CSA rated data	2x 0.5 - 2.5 mm <sup>2</sup> 2x 18 - 12 AWG	1x 0.5 - 2.5 mm <sup>2</sup> 1x 18 - 12 AWG	1x 0.2 - 2.5 mm <sup>2</sup> 1x 24 - 12 AWG
Flexible with end sleeve	2x 0.5 - 2.5 mm <sup>2</sup> 2x 18 - 12 AWG	1x 0.5 - 2.5 mm <sup>2</sup> 1x 18 - 12 AWG	-
Torque specification	Posidrive 1 UL: 0.5 Nm (4.4 lb-in), IEC: 0.5-0.6 Nm (4.4-5.3 lb-in)		-

## Bulk packaging option



- Packing qty.: 40 pcs.
- Total weight : approx. 4.2 Kgs



COPYRIGHT ©2022  
Content subject to change.  
Download the PDF: <https://gavazziautomation.com>

## X-ON Electronics

Largest Supplier of Electrical and Electronic Components

*Click to view similar products for [Solid State Relays - Industrial Mount](#) category:*

*Click to view products by [Carlo Gavazzi](#) manufacturer:*

Other Similar products are found below :

[D2440-C](#) [H10CA4890](#) [H10CD4890](#) [D4840B](#) [D4875C](#) [1395831-1](#) [SE-K4EN](#) [A-1326](#) [H10CA4850](#) [H12CA4890VL](#) [RA2410-D06](#)  
[RA2410HA06T](#) [TD1205](#) [D53TP50-10](#) [W230E-1-12](#) [W230T-3-12](#) [1-1617030-3](#) [MS2-D2420](#) [MS2-D2430](#) [A-1440](#) [G3TAOD201SDC24](#) [1-](#)  
[1617033-0](#) [G3SD-Z01P-PE](#) [DC24](#) [SMT8628521](#) [ESUC0480](#) [SRH3-1440R](#) [XKA70420](#) [G3PH-5150BAC100-240](#) [GN325DSZH](#)  
[GN350ASZH](#) [GN325ASZH](#) [GN350DSZH](#) [1109564](#) [G3NB-225B-1](#) [DC5-24](#) [GNRD06CDL](#) [GN325DSRH](#) [GNR25DCZH](#) [52511](#) [CWH-62-](#)  
[WO](#) [E-1048-8I4-C3D4V1-4U3-10A](#) [E-1048-8I4-C3D1V0-4U3-5A](#) [RGC1P60CM25KEN](#) [48ATE3S00X204](#) [48BTG3S00X204](#) [GNR25ACZH](#)  
[RA4025H10PCS](#) [RKD2A60D50P](#) [RK2A60D50P](#) [RK2A60D75P](#) [PVG612](#)