

Solid State Relays

SOLITRON MIDI Multi-Function Analog Switching

Type RJ1P



- AC semiconductor contactor
- Multi-function - 5 selectable modes of operation: Phase Angle, Distributed Full Cycle and Burst Control (1, 3 and 10s)
- Direct copper bonding (DCB) technology
- LED-indication for control and load status
- Operational ratings up to 50 AACrms and 600 VAC
- 4-20mA or 0-10V control input
- Built-in varistor
- Blocking voltage: Up to 1200Vp
- Opto-isolation > 4000VACrms
- Cage clamp terminals
- IP20 protection
- Option for over-temperature protection with alarm output

Product Description

The Solitron Midi Analog Switching is a single-phase SSR that provides proportional output power in relation to the control signal level applied. This microprocessor-based device provides for 5 different switching modes integrated into one package. A selector switch on the front of the device is used for the selection of the preferred mode of operation, i.e., either Phase Angle, Distributed Full Cycle or Burst

Control. This multi-function selection makes this device ideal for the control of a variety of loads, including heaters and lamps. The control signal can be either 4 - 20mA or 0 - 10VDC. 4mA or 0V correspond to zero output power, whilst 20mA or 10VDC correspond to full output power.

The product is ready to mount on DIN-rail or chassis and comes with integral heatsink.

Ordering Key **RJ 1 P 48 V 50 E P PO**

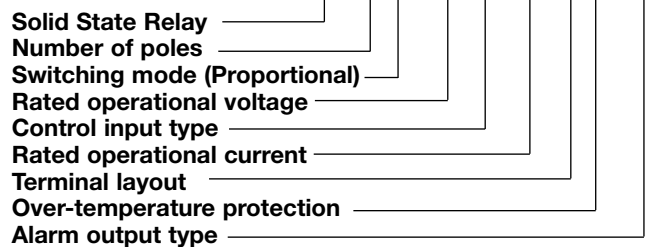

Type Selection

Switching mode	Rated operational voltage	Control input	Rated operational current	Terminal layout	Protection	Alarm output type
P: Proportional Output	23: 230VACrms 48: 480VACrms 60: 600VACrms	V: 0 - 10VDC I: 4 - 20mA	30: 30AACrms 50: 50AACrms	E: Contactor	P: Over-temperature protection	PO: *1 NO: *2

*1 PNP, Normally Open

*2 NPN, Normally Open

Selection Guide

Rated operational voltage	Blocking voltage	Control input	Supply voltage	Alarm output type	Rated operational current	
					30 A	50 A
230VACrms	650Vp	0-10VDC	24VAC/DC	-	RJ1P23V30E	RJ1P23V50E
				PO	RJ1P23V30EPP0	RJ1P23V50EPP0
		4-20mA	-	RJ1P23I30E	RJ1P23I50E	
			PO	RJ1P23I30EPP0	RJ1P23I50EPP0	
480VACrms	1200Vp	0-10VDC	24VAC/DC	-	RJ1P48V30E	RJ1P48V50E
				PO	RJ1P48V30EPP0	RJ1P48V50EPP0
		4-20mA	-	RJ1P48I30E	RJ1P48I50E	
			PO	RJ1P48I30EPP0	RJ1P48I50EPP0	
600VACrms	1200Vp	0-10VDC	24VAC/DC	-	RJ1P60V30E	RJ1P60V50E
		4-20mA	-	RJ1P60I30E	RJ1P60I50E	

Note: Alarm Output: EPNO (NPN, normally open) and 600V types available only on request

General Specifications

	RJ1P23...	RJ1P48...	RJ1P60...
Operational voltage range	90 to 265VAC	200 to 550VAC	410 to 660VAC
Blocking voltage	650V _p	1200V _p	1200V _p
Operational frequency range	45 to 65Hz	45 to 65Hz	45 to 65Hz
Output power	0 to 99%	0 to 99%	0 to 99%
Power factor	≥ 0.9 @ 230VACrms	≥ 0.9 @ 480VACrms	≥ 0.9 @ 600VACrms
Load status indication	Red LED	Red LED	Red LED
Output power resolution	MODE 1 Phase Angle 1/300 @ 50Hz, 1/300 @ 60Hz MODE 2 Full Cycle 1/64 @ 50Hz, 1/64 @ 60Hz MODE 3 Burst with 1s period 1/50 @ 50Hz, 1/60 @ 60Hz MODE 4 Burst with 3s period 1/150 @ 50Hz, 1/180 @ 60Hz MODE 5 Burst with 10s period 1/500 @ 50Hz, 1/600 @ 60Hz		
Approvals	UL, cUL*		
CE-marking	Yes		

* Approvals pending for RJ1P...P.O models

Input Specifications

	RJ1P..I...		RJ1P..V...
Current controlled input		Voltage controlled input	
Control current range	4 - 20mA	Supply voltage range, V _{ss}	20 - 28VAC/DC
Max. allowable input current	50mA	Supply current	18mA @ 24VDC 23mA @ 24VAC
Pick up current	4.2mA	Control voltage range, V _{cc}	0 - 10VDC
Drop out current	3.9mA	Control input current	0.1mA @ 10VDC
Control status indication	Green LED	Reverse polarity protected	Yes
Reverse polarity protected	Yes	Pick up voltage	0.5VDC
Voltage drop	10VDC @ 20mA	Drop out voltage	0.05VDC
		Control status indication	Green LED

Note: the use of twisted pair cable for the control input is recommended

Output Specifications

	RJ1P...30	RJ1P...50
Rated operational current AC51 @Ta=25°C	30AACrms	50AACrms
Min. operational current	150mAACrms	500mAACrms
Rep. overload current t=1 s (T _j init.=25°C)	< 55AACrms	< 200AACrms
Non-rep. surge current t=10 ms (T _j init.=25°C)	325A _p	1900A _p
Off-state leakage current, @ rated voltage and frequency	< 3 mArms	< 3 mArms
I ² t for fusing t=10 ms	525A ² s	18000A ² s
On-state voltage drop @ rated current	1.6Vrms	1.6Vrms
Critical dV/dt off-state	1000V/μs	1000V/μs

Isolation

Rated isolation voltage	
Input to output	≥ 4000 VACrms
Output to case	≥ 4000 VACrms

Thermal Specifications

Operating temperature	-20 to +70°C (-4 to +158 °F)
Storage temperature	-40 to +100°C (-40 to +212 °F)

Connection Examples

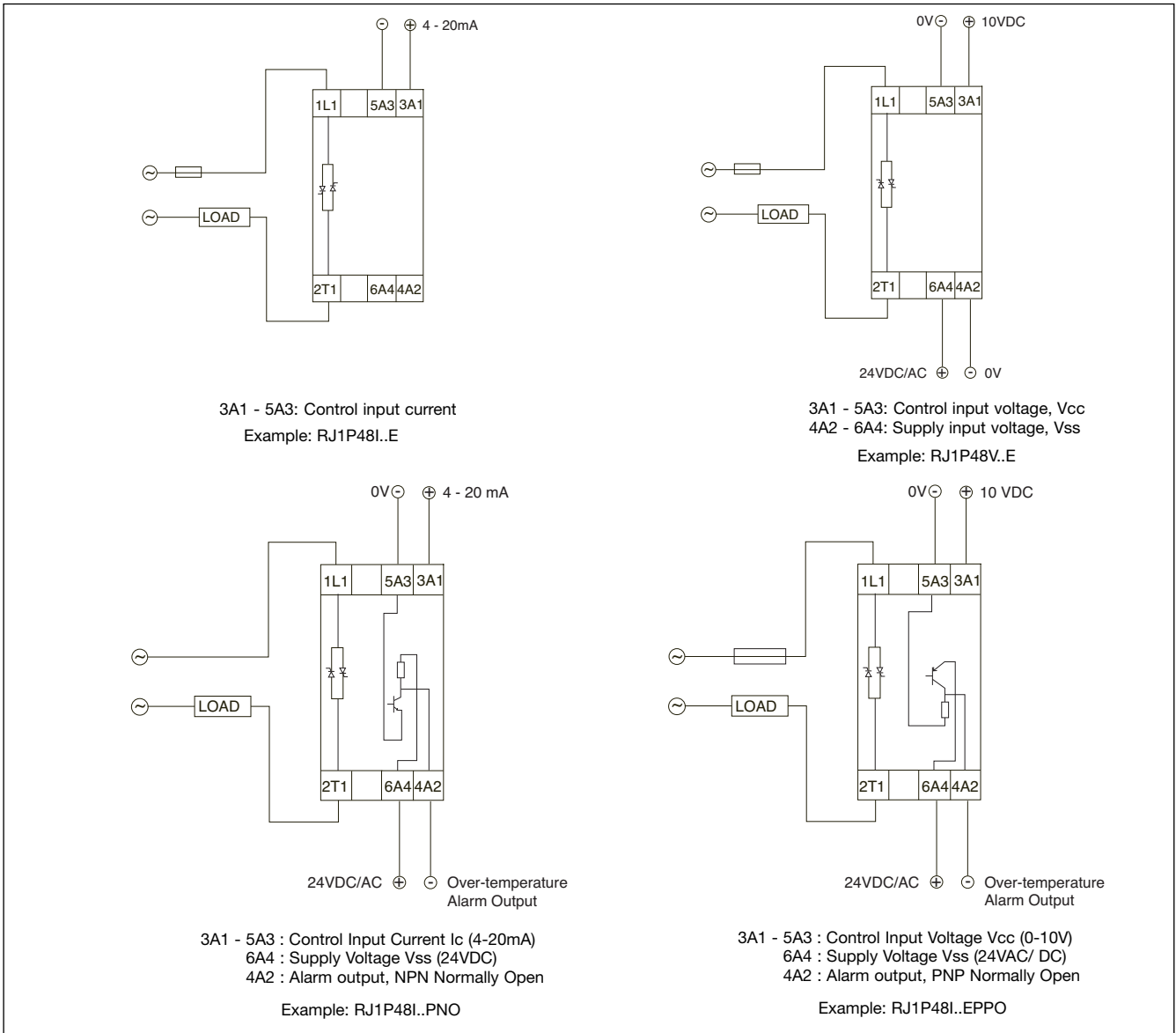

Note: For the RJ1P.V.E, it is possible to have the ground terminals of the supply and control power supplies used commoned. In the case, this common ground is connected either to terminal A2 or terminal A3. This is only applicable when a 24 VDC supply voltage is used. There should be no external direct link from Terminal A2 to Terminal A3.

Alarm Specifications

Output current	≤ 50 mADC
Output voltage	
NPN	1V
PNP (Voltage version)	V _{cc} - 1 - 82 i _o
PNP (Current version)	V _{cc} - 3 (0.50 mA)
No. of outputs in parallel	≤ 50

Operation

MODE 1: The Phase Angle switching mode works in accordance with the phase angle control principle, i.e. the output switching point in the AC sine wave depends on the signal level applied at the input. The relay switches off everytime the output current crosses zero.

MODE 2: The Distributed mode provides a number of full cycles, evenly distributed over a fixed period of 1.28s @ 50Hz (1.07s @ 60Hz), depending on the control input.

MODE 3, 4, 5: The Burst Switching mode generates a number of full cycles, depending on the control input over fixed periods of 1s, 3s or 10s for MODES 3, 4 and 5 respectively.

Modes 2, 3, 4 and 5 use the zero switching principle, thus ensuring a reduced level of radiated and wire-conducted noise. The Distributed and Burst Switching modes are not recommended for light control due to light-flickering.

LED INDICATION

The top RED LED indicates the load status. It goes ON whenever the load is activated, and in the RJ1P...P.O models this led is used to indicate an over temperature alarm. The Green LED gives indication of the status of the control input.

Upon application of control current (for the RJ1P..I..) to terminals A1 – A3, the Green LED will be dimly lit, with its intensity increasing with an increase in control current.

For the RJ1P.V.. the Green LED will be ON (flickering) upon application of the supply voltage to terminals A3 – A4. In RJ1P.VE only, terminals A3 and A2 are shorted. Once a control voltage is applied to terminals A1 – A3, the Green LED will be fully ON, if greater than a threshold voltage (approx 0.5V). Note that the first time the device (voltage control version) is to be activated, the mains voltage has to be present for the Green LED to indicate the control status.

Terminal Layout

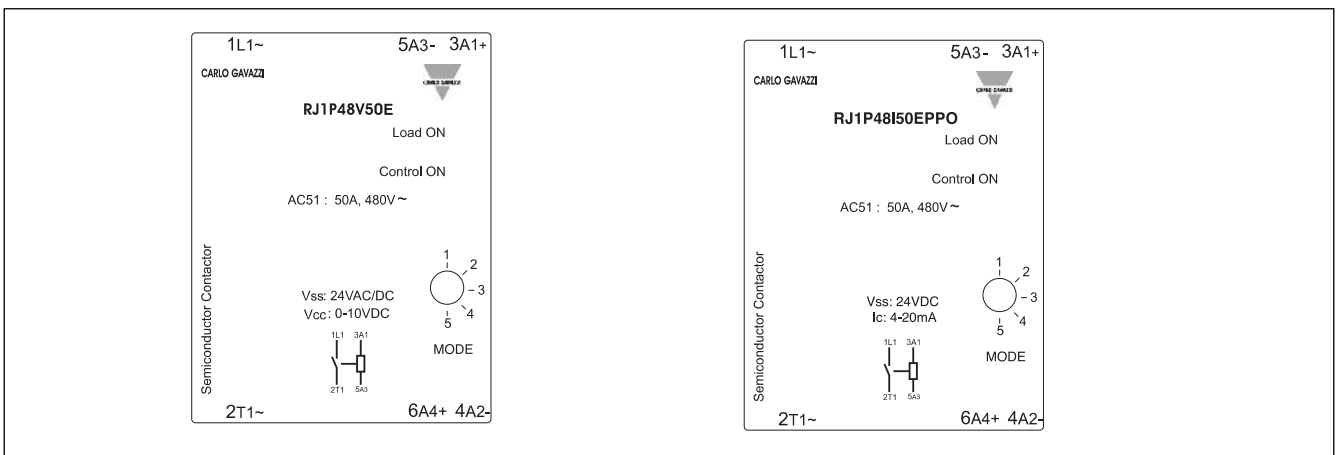

Transfer characteristics

Output power as a function of control input

Control Current (mA)	Control Voltage (VDC)	Output Power (%)
4	0	0
8	2.5	25
12	5	50
16	7.5	75
20	10	99

Mode Selection

- MODE 1 Phase Angle Switching
- MODE 2 Distributed Control
- MODE 3 Burst Switching (1 sec. period)
- MODE 4 Burst Switching (3 sec. period)
- MODE 5 Burst Switching (10 sec. period)

Dissipation Curve

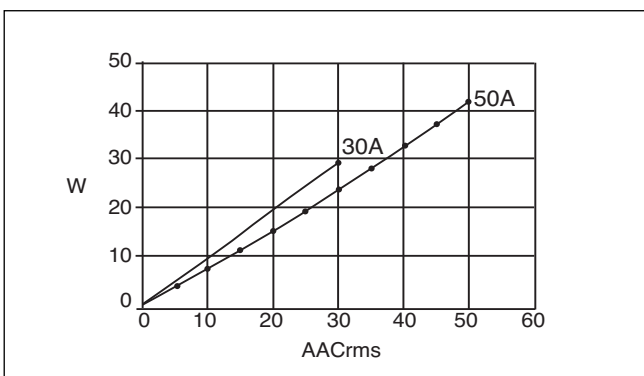

Functional Diagram

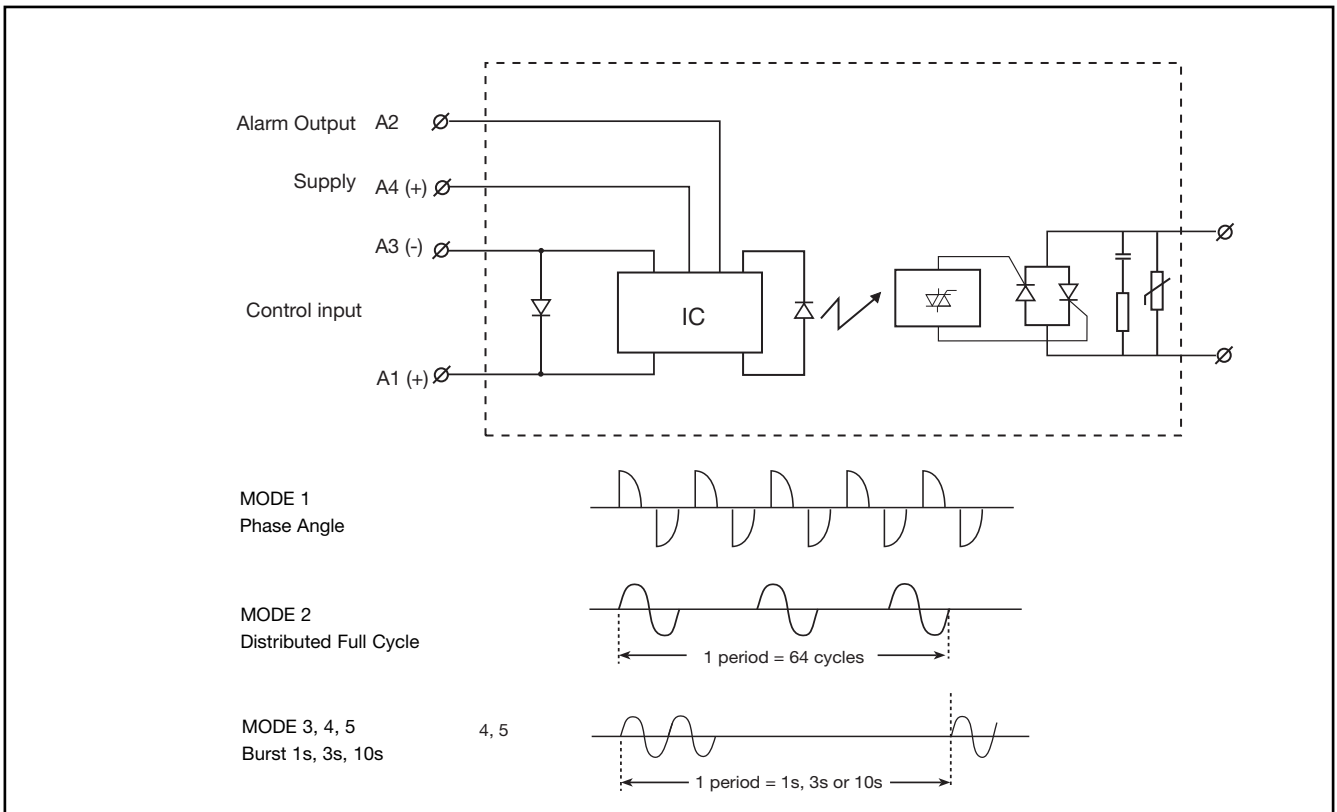

Dimensions

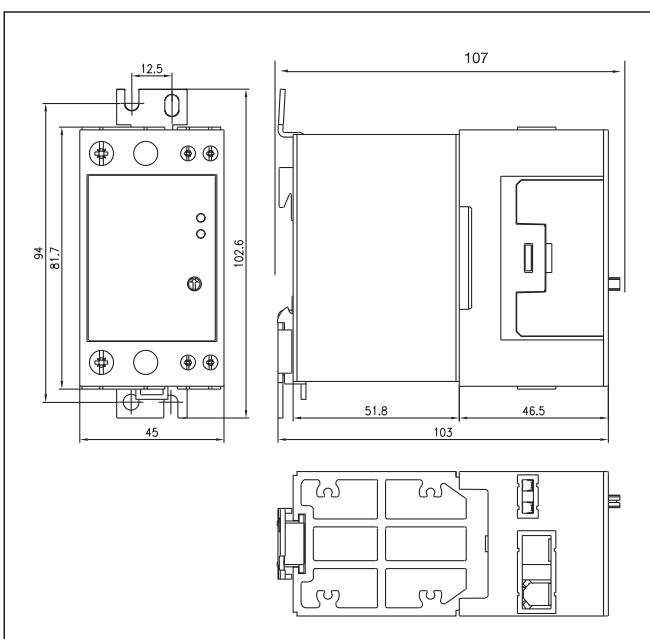

All dimensions in mm.

Housing Specifications

Weight	Approx. 430 g
Housing material	PBT Flame retardant
Control terminal cable size	1 x 0.5 mm ² (1 x AWG20)
Min	1 x 4.0 mm ² (1 x AWG12) or
Max	2 x 2.5 mm ² (2 x AWG14)
Mounting torque max.	0.6 Nm Posidriv 0 bit
Control terminal screw	M3
Power terminal cable size	1 x 4 mm ² (1 x AWG12)
Min	1 x 25 mm ² (1 x AWG3) or
Max	2 x 10 mm ² (2 x AWG6)
Mounting torque max.	2.5 Nm Posidriv 2 bit
Power terminal screw	M5

Derating vs. Spacing Curves

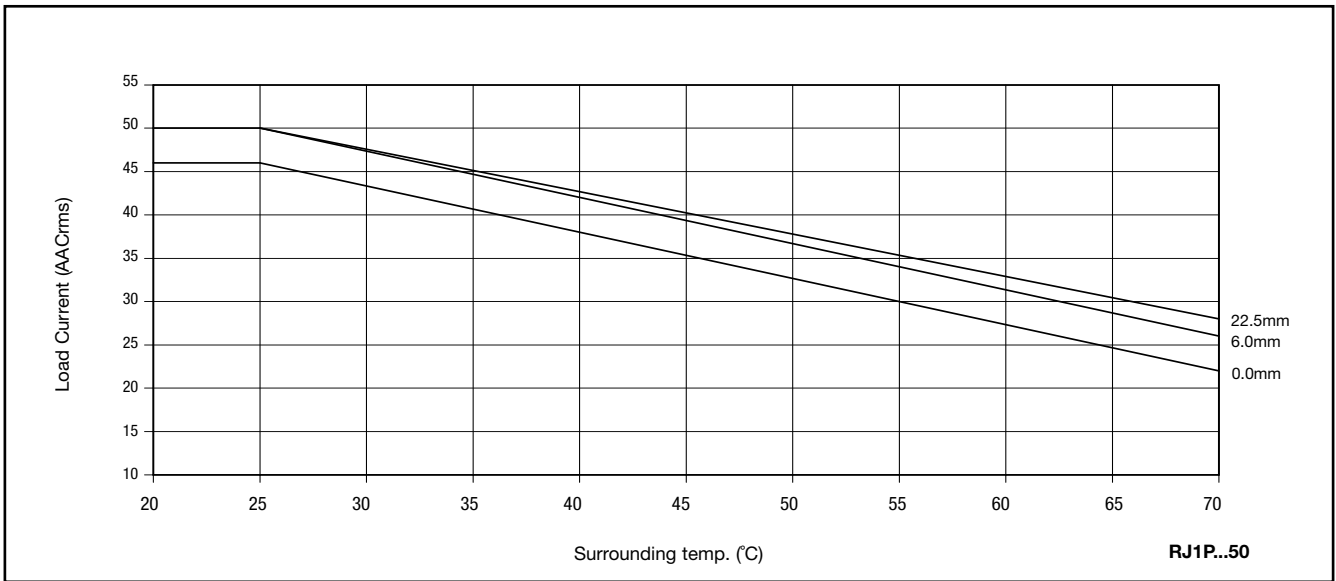
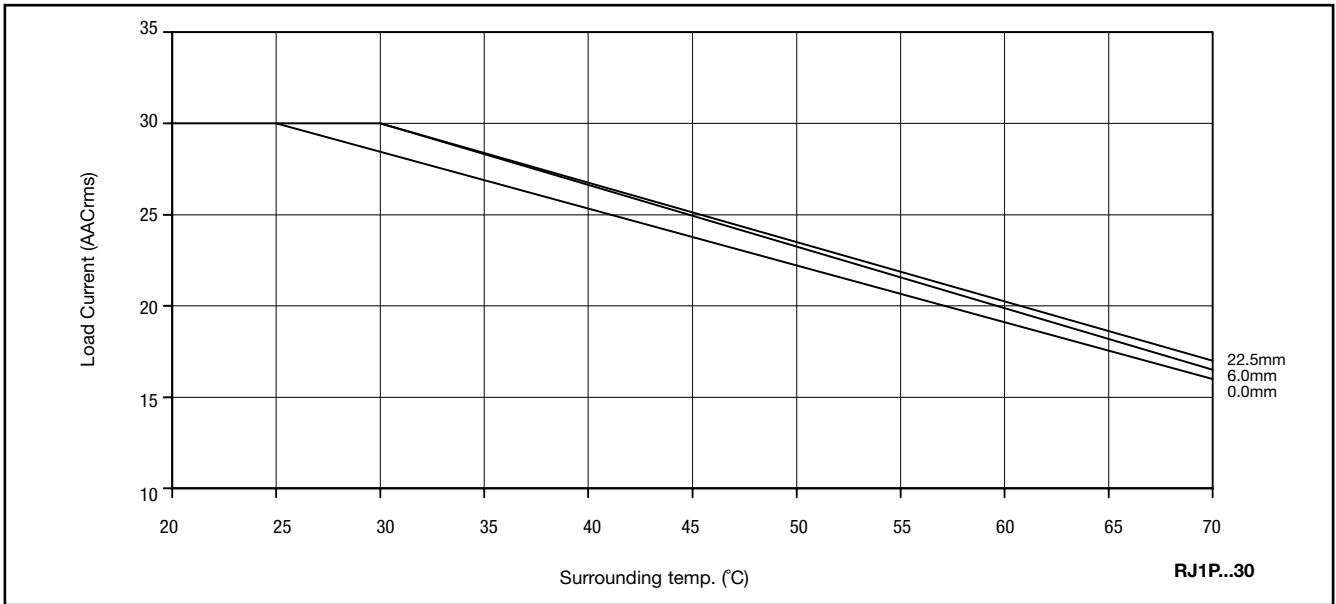

Note: Based on 100% output power

Functional Diagram

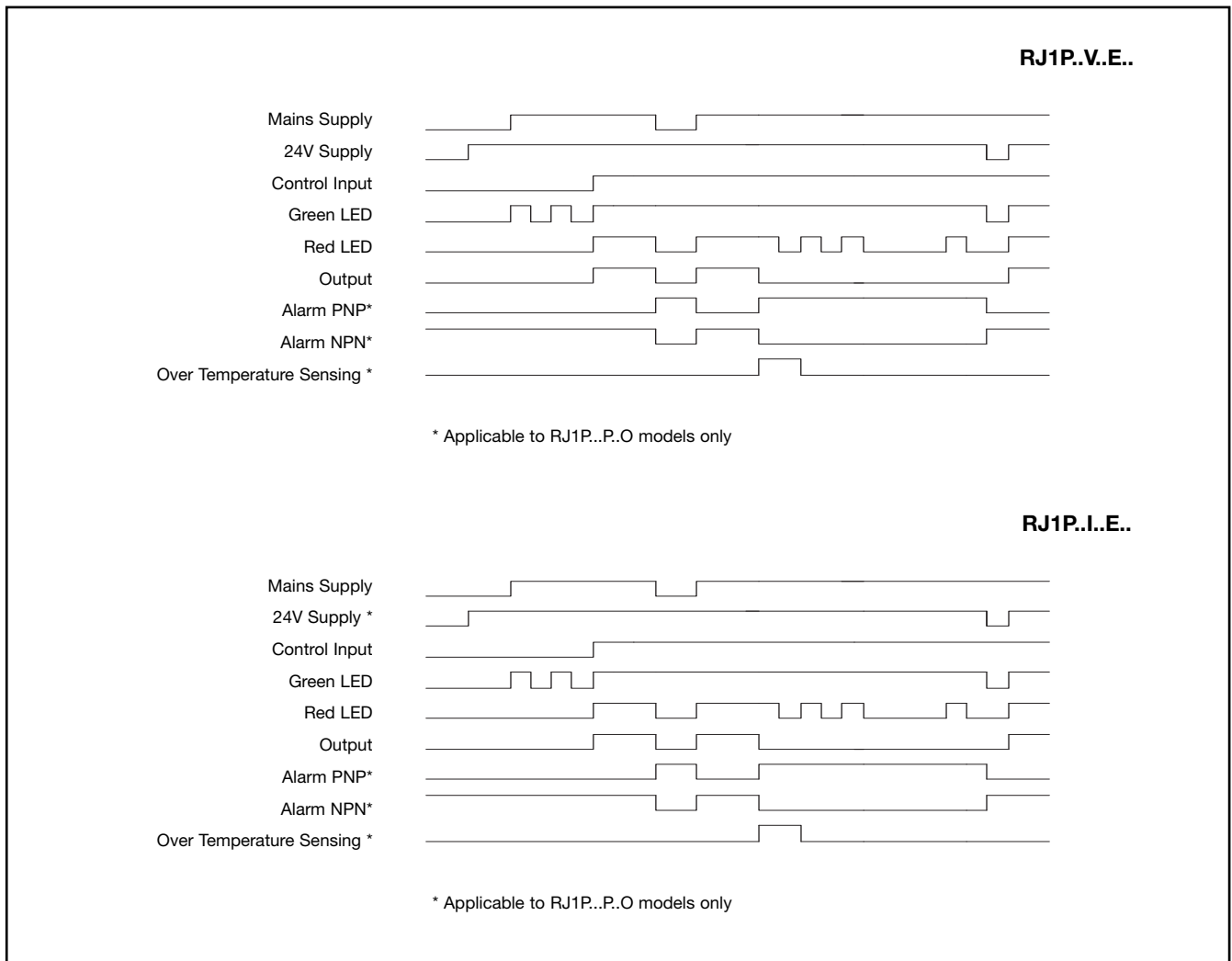

X-ON Electronics

Largest Supplier of Electrical and Electronic Components

Click to view similar products for [Solid State Relays - Industrial Mount](#) category:

Click to view products by [Carlo Gavazzi](#) manufacturer:

Other Similar products are found below :

[D2440-C](#) [H10CA4890](#) [D4875C](#) [D53TP50DH-10](#) [1395831-1](#) [1616010-6](#) [BR312BY](#) [A-1326](#) [H10CA4850](#) [H12CA4890VL](#) [RA2410-D06](#)
[RA2410HA06T](#) [D1202F](#) [D53TP50-10](#) [W230E-1-12](#) [W230T-3-12](#) [1-1617030-3](#) [1-1617033-7](#) [MS2-D2420](#) [MS2-D2430](#) [A-1440](#)
[RJ1P60V50E](#) [HS501DR-D2425](#) [RN1F48I50](#) [70.362.1028.0](#) [7-1393030-8](#) [Z5.509.0828.0](#) [G3DZ-4B DC24](#) [G3DZ-F4B DC12](#) [SSRDAC10](#)
[RV8S-L-A240-D24](#) [RV8S-L-A240-D6](#) [RV8S-S-A240-D24](#) [RV8S-S-A240-D6](#) [RV8S-S-A240Z-D24](#) [RV8S-S-D24-A240](#) [RV8S-S-D48-A120](#)
[RN1F12V50](#) [RJ1P60I30E](#) [RJ1P60V30E](#) [SO967860](#) [SMT8628521](#) [SO869970](#) [SOD867180](#) [SAL961360](#) [SO867970](#) [SOB863860](#)
[SOB867640](#) [SOB942360](#) [G3PH-5150B DC5-24](#)