

# Solid State Relays Zero Switching Type RMD Hybrid Relay

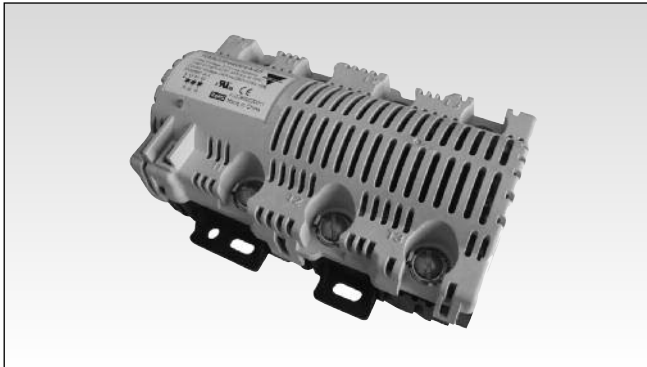

- Hybrid Relay: SSR + EMR combination
- Current rating @ 60°C: 30 AAC, 40 AAC
- Nominal voltage ratings: 240 VAC, 227 VAC/ 480 VAC + Neutral
- Control voltage: 24 VAC, 120 VAC, 240 VAC
- Mercury-free, leading to a safer environment
- Similar mounting to mercury relays
- RoHS compliant
- Switching with arc-free operation
- Switching rate: up to 20 cycles per minute
- Operating life: 4 million operating cycles

## Product Description

RMD3H combines the benefits of solid state relays and electro-mechanical relays to provide a hybrid relay. This means that there is virtually no contact arcing and much less heat emission inside the panel. RMD3H switches heaters on three legs while RMD2H has two poles which are switched and the

third one is directly connected between the L2 and the T2 terminals. This hybrid relay also provides a solution which does not contain mercury and is RoHS compliant. The maximum current reached per pole is 40AAC in a surrounding temperature of 60°C (140°F).

## Ordering Key

**RMD 3 H 48 HA 40**

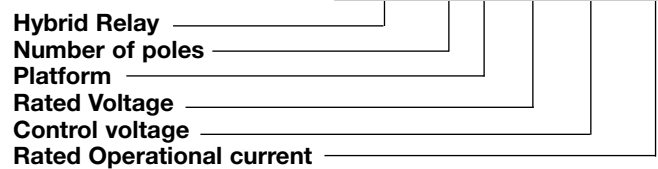

## Selection Guide

Rated Voltage	Blocking Voltage	Number of switched Poles	Rated Control Voltage	Rated operational current at 60°C surrounding temperature	
				30 Arms	40 Arms
240Vrms (1phase loads) (3phase delta)	600Vp	2	24 VAC/DC	RMD2H24LA30	RMD2H24LA40
			120 VAC	RMD2H24MA30	RMD2H24MA40
			240 VAC	RMD2H24HA30	RMD2H24HA40
240Vrms (3phase delta)	600Vp	3	24 VAC/ DC	RMD3H24LA30	RMD3H24LA40
			120 VAC	RMD3H24MA30	RMD3H24MA40
			240 VAC	RMD3H24HA30	RMD3H24HA40
480Vrms (3phase star+Neutral)	600Vp	3	24 VAC/ DC	RMD3H48LA30	RMD3H48LA40
			120 VAC	RMD3H48MA30	RMD3H48MA40
			240 VAC	RMD3H48HA30	RMD3H48HA40

## General Specifications

	RMD..24	RMD..48
Operational voltage Range	240 VAC -15% / +10%	277 VAC (480 VAC with neutral connection) -15%/+10%
Non-rep peak voltage	600 Vp	
Operational frequency range	45 - 65Hz	
Power factor	> 0.90	
CE marking	Yes	
Finger Protection	IP20	
Operating life	4 million cycles	
Control input status	continuously ON Green LED when control input is applied	
Varistor protection across outputs	420V	
Pollution degree	2 (non-conductive pollution with possibilities of condensation)	
Over-voltage category	III (fixed installations)	
Isolation - input to Output	4000Vrms	
RoHS compliance	YES	



## Input Specifications

	RMD..LA	RMD..MA	RMD..HA..
Rated Control voltage range	24 VAC/DC +10/-15%	120 VAC +10/-15%	240 VAC +10/-15%
Pick-up voltage	15 VAC/ 9 VDC	36 VAC	90 VAC
Drop-out voltage	15 VAC/ 9 VDC	36 VAC	90 VAC
Maximum Input current	400 mA	400 mA	400 mA
Response time pick-up ZC	0.5 cycle	0.5 cycle	0.5 cycle
Response time drop-out	2 cycles	2 cycles	2 cycles

## Output Specifications

	RMD..30	RMD..40
Rated operational current (see derating curve)	30 AAC	40 AAC
Min. operational current	150 mA	150 mA

## Derating Curves

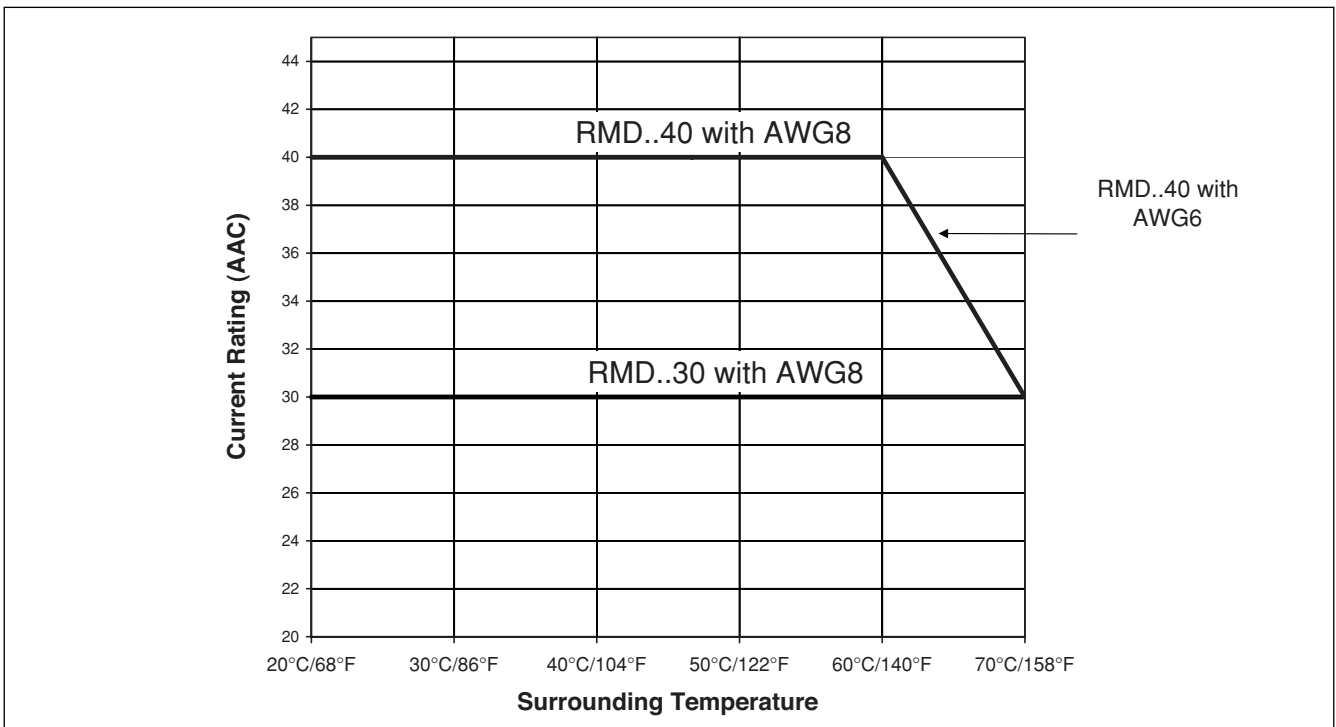

## Agency Approvals & EMC

<b>CE marking</b>		<b>Approvals</b>	cURus (E80573)
Low Voltage Directive	IEC / EN 60947-4-3	<b>Endurance Test</b>	100,000 cycle as per UL508
EMC Immunity	IEC / EN 61000-6-3	<b>Restrictions of hazardous substances</b>	RoHS
EMC Emission	IEC / EN 61000-6-1	<b>Radiated Radio Frequency Immunity</b>	EN 61000-4-3
<b>Electrostatic Discharge (ESD) Immunity</b>	IEC / EN 61000-4-2 8kV, PC2 Air discharge 4kV, PC2 Contact	10 V/m, 80 - 1000 MHz, 1.4 - 2.0 GHz 1 V/m, 2.0 - 2.7 GHz	Performance criteria 1 Performance criteria 1
<b>Electrical Fast Transient Burst Immunity</b>	IEC / EN 61000-4-4 Output 2kV, performance criteria 1 Input 1kV, performance criteria 1	<b>Conducted Radio Frequency Immunity</b>	IEC / EN 61000-4-6 Performance criteria 1
<b>Electrical Surge Immunity</b>	IEC / EN 61000-4-5 Output, line to line 1kV, performance criteria 1 Output, line to earth 2kV, performance criteria 1 Input, line to line 1kV, performance criteria 2 Input, line to earth 2kV, performance criteria 2	<b>Voltage Dips Immunity</b>	IEC / EN 61000-4-11 0% for 10ms/20ms, 70% for 500ms 40% for 200ms
<b>Radio Interference field emissions (radiated)</b>	IEC / EN 55011 Class B (light industry)	<b>Voltage Interruptions Immunity</b>	IEC / EN 61000-4-11 Performance criteria 3
		<b>Radio Interference voltage emissions (conducted)</b>	EC / EN 55011 Class A (industrial)

## Connection Specifications

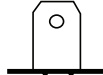
Connection Type	Power Connection Screw terminal	Control Connection FASTON terminal
Illustration of terminal		
Terminal Designations	1L1, 2T1, 3L2, 4T2, 5L3, 6T3, 7N	A1, A2
Rigid (Solid or Stranded)	1 x (2.5-16)mm <sup>2</sup> 1 x (14-6)AWG	N/A
Tightening torque	18 in lb (2.1Nm)	N/A
Size	No. 10 screw	6.35mm (1/4 inch) FASTON
Aperture for termination lug	Max 13.5mm for ring and fork/spade termination lugs	

## Housing Specifications

Weight	approx. 360g
Housing Material	PA66
Flame class	UL94V0
Dimensions (w x h x d) (without input connector)	105 x 45 x 90 mm

## Environmental Specifications

Operating Temperature	0 to 70°C
Storage Temperature	0 to 100°C
Humidity	95% RH, non condensing @ 40°C
Impact resistance	15/11 g/ms

## Connection Diagrams

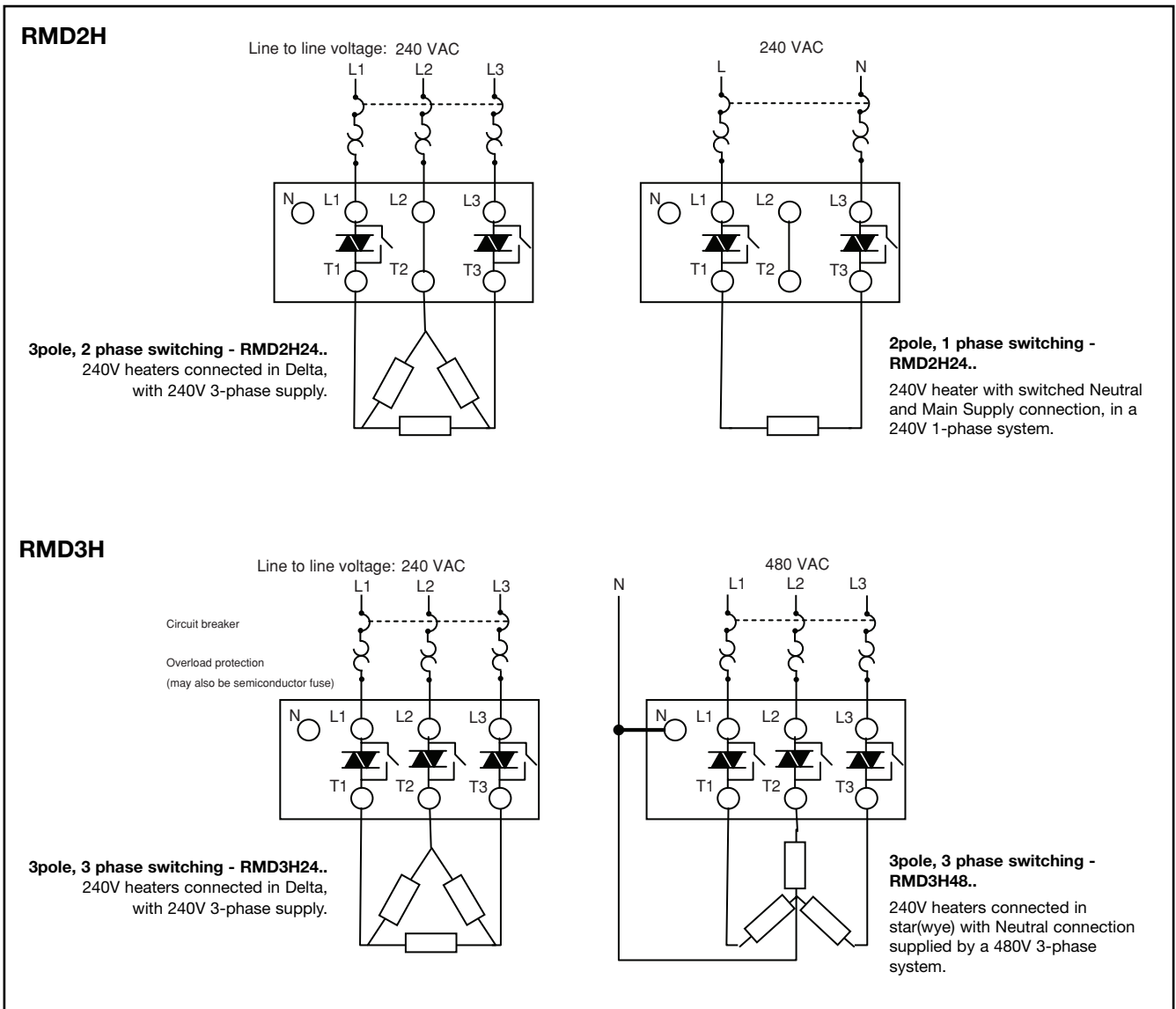

### Dimensions (mm)

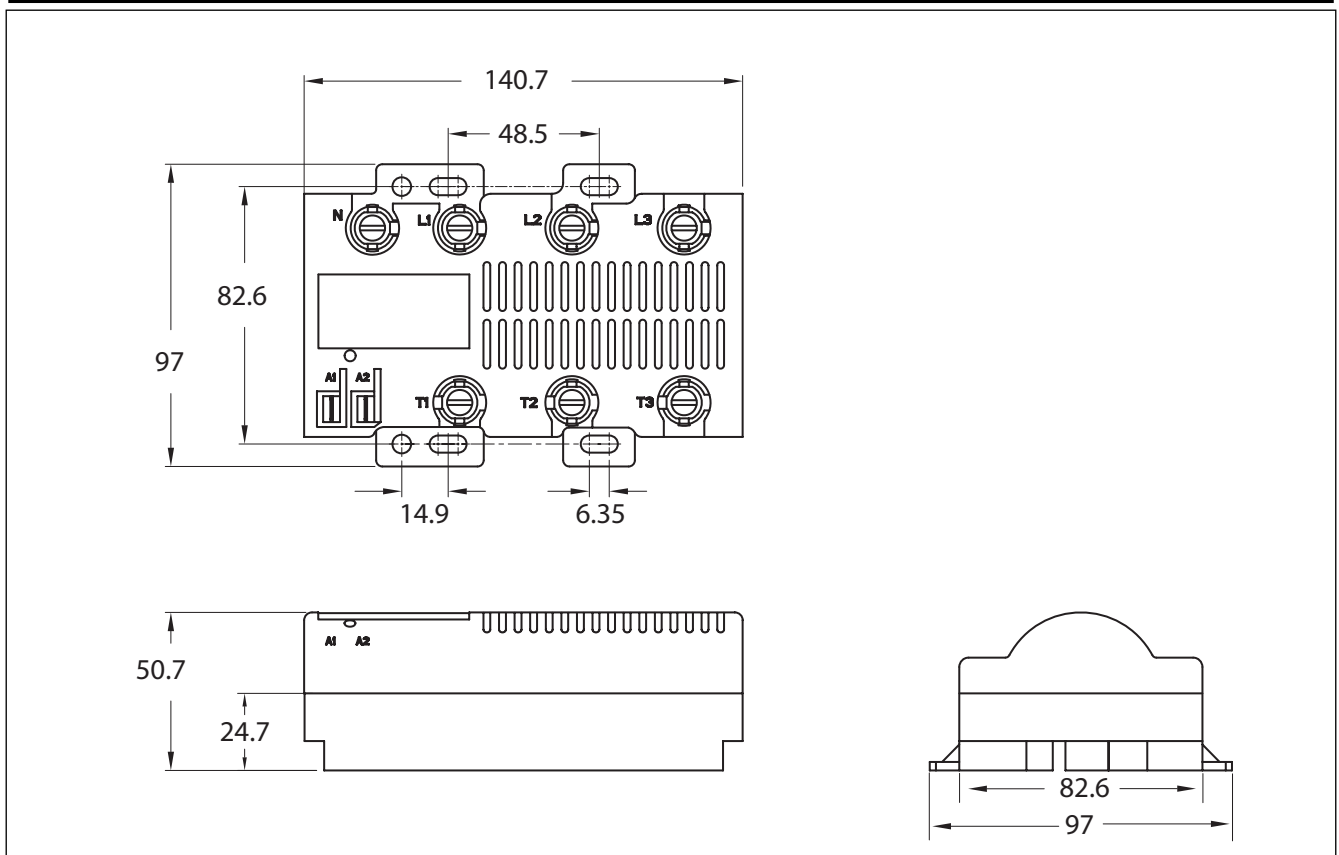

## X-ON Electronics

Largest Supplier of Electrical and Electronic Components

*Click to view similar products for [Solid State Relays - Industrial Mount](#) category:*

*Click to view products by [Carlo Gavazzi](#) manufacturer:*

Other Similar products are found below :

[D2440-C](#) [H10CA4890](#) [D4875C](#) [D53TP50DH-10](#) [1395831-1](#) [1616010-6](#) [BR312BY](#) [A-1326](#) [H10CA4850](#) [H12CA4890VL](#) [RA2410-D06](#)  
[RA2410HA06T](#) [D1202F](#) [D53TP50-10](#) [W230E-1-12](#) [W230T-3-12](#) [1-1617030-3](#) [1-1617033-7](#) [MS2-D2420](#) [MS2-D2430](#) [A-1440](#)  
[RJ1P60V50E](#) [HS501DR-D2425](#) [RN1F48I50](#) [70.362.1028.0](#) [7-1393030-8](#) [Z5.509.0828.0](#) [G3DZ-4B DC24](#) [G3DZ-F4B DC12](#) [SSRDAC10](#)  
[RV8S-L-A240-D24](#) [RV8S-L-A240-D6](#) [RV8S-S-A240-D24](#) [RV8S-S-A240-D6](#) [RV8S-S-A240Z-D24](#) [RV8S-S-D24-A240](#) [RV8S-S-D48-A120](#)  
[RN1F12V50](#) [RJ1P60I30E](#) [RJ1P60V30E](#) [SO967860](#) [SMT8628521](#) [SO869970](#) [SOD867180](#) [SAL961360](#) [SO867970](#) [SOB863860](#)  
[SOB867640](#) [SOB942360](#) [G3PH-5150B DC5-24](#)