

# SPDC



## Single Phase Compact Power Supply



### Description

The SPDC power supplies is a range where high performance meets high quality in a compact frame. These power supplies are offered in 120W, 240W, 480W, and they have a universal input voltage range 85VAC to 264VAC and 130VDC to 350VDC. The SPDC achieve a high energy efficiency of up to 94%, and can be connected in parallel to achieve twice the current. Reliability is guaranteed through the multiple integrated protections, and it also comes with built-in active PFC. SPDC coupled compact dimensions with advance features to provide a power supply for all automation applications requiring reliability, quality and performance.

### Benefits

- **Reliable power in very compact dimensions.** This SPDC has an ultra-slim DIN rail body, with up to 480W in only 70mm width of space
- **Built-in active PFC.** The power factor correction (PFC) circuit adjusts the power factor to 0.99@110Vac and 0.95@230Vac.
- **Parallel function.** The SPDC can easily be connected in parallel to provide for increased power or used in redundancy operations.
- **150% Power Boost.** The SPDC can provide 150% of the rated output power for up to 3 seconds, providing the extra power needed during critical startups.
- **Universal AC, DC input range.** SPDC Series can be powered with AC Voltage (85VAC to 264VAC) or with DC Voltage (130VDC to 350VDC).
- **Reliable critical protection.** Safety and reliability is guaranteed by the various output protections: Over Voltage (OVP), Over Load (OLP), Short Circuit (SCP) and Over Temperature (OTP).
- **High efficiency and wide operating ambient temperature.** The SPDC has a very high efficiency of up to 93.8%. The operating temperature range is, from -25°C to +60°C (without derating), and up to 70°C with -25% derating.
- **Ease of installation.** The SPDC can be installed in 5 different orientations, enabling the unit to fit easily into installation with limited space.

### Applications

The SPDC is extremely suitable for applications which requires high efficiency, high safety standards and high PF corrections. It also provides the DC OK signaling with LED and relay output.

### Main functions

- High Efficiency up to 93.8%
- In-built active PFC, PF>0.95
- Output options of 12VDC, 24VDC or 48VDC
- Universal input voltage range: 85VAC to 264VAC; 130VDC to 350VDC
- Bi-colour LED for Status, and DC-OK relay contact
- Parallel function

## References

### Order code



SPDC   1

Enter the code entering the corresponding option instead of

Code	Option	Description	Notes
S	-	Switching	Device typology
P	-	Power	
D	-	DIN rail	
C	-	Compact	
<input type="checkbox"/>	12	12VDC	Rated output voltage
	24	24VDC	
	48	48VDC	
<input type="checkbox"/>	120	120W	Rated output power
	240	240W	
	480	480W	
1	-	Single phase input	Input type

### Selection guide

Output Voltage	120W	240W	480W
12VDC	SPDC121201	-	-
24VDC	SPDC241201	SPDC242401	SPDC244801
48VDC	-	-	SPDC484801

### Further reading

Information	Where to find it	QR
SPDC DatasheetSheet	<a href="http://www.productselection.net/Pdf/UK/PS_SPDC_DS.pdf">http://www.productselection.net/Pdf/UK/PS_SPDC_DS.pdf</a>	
SPDC Installation Sheet	<a href="http://www.productselection.net/MANUALS/UK/PS_SPDC_IM.pdf">http://www.productselection.net/MANUALS/UK/PS_SPDC_IM.pdf</a>	
SPDC CAD drawings	<a href="http://www.productselection.net/DXF/PS_SPDC.zip">http://www.productselection.net/DXF/PS_SPDC.zip</a>	

# SPDC



## Structure

SPDC 120W

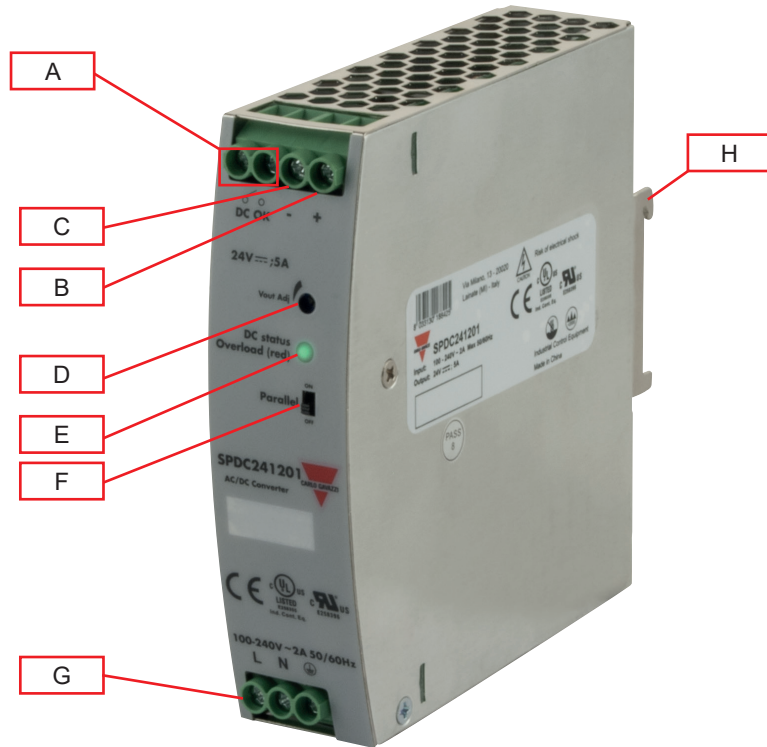

SPDC 240W

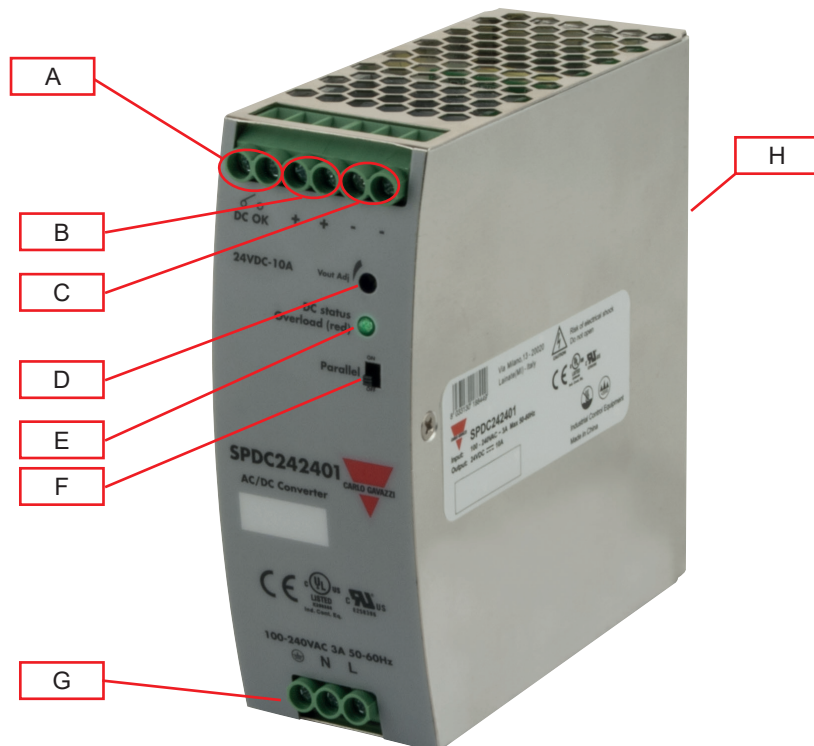

# SPDC



## SPDC 480W

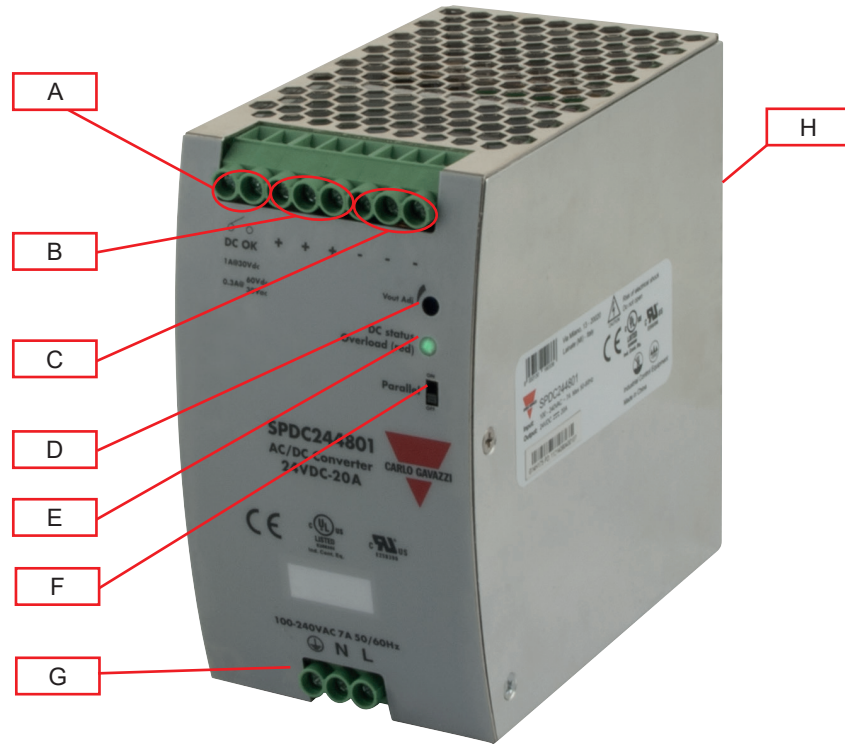

Element	Component	Function
A	DC OK Relay contacts	Output status. Max 30V/1A or 60V/0.3A or 30Vac/0.3A Resistive load
B	+ V terminals	Positive DC Output terminals
C	- V terminals	Negative DC Output terminals
D	VADJ Trimmer	Output voltage adjustment
E	DC OK LED	Green when output voltage $\geq 90\%$ of rated output voltage Red when output voltage $\leq 80\%$ of rated output voltage, or, Overload
F	Single/Parallel Switch	Enabling or disabling of output parallel connection function
G	Power supply terminals	L, N supply terminals + GND
H	DIN rail mounting clip	Clip present on back side

## Features

### General data

	SPDC 120W	SPDC 240W	SPDC 480W
Leakage current	<0.25mA (Input-Output)		
Earth leakage current	<3.5mA (Input-GND)		
Efficiency	89.5% (12VDC) 91% (24VDC)	94% (24VDC)	93.8% (24VDC) 93.8% (48VDC)
Power loss @ nominal load	15W	23W	35W
Power Factor (Full Load) 110VAC 230VAC	0.99 0.95		
Ingress Protection	IP20		
MTBF (MIL-HDBK-217F)	>300,000Hrs		
Case material	Metal, Stainless Steel		
Weight	550g (1.21lb)	780g (1.72lb)	1150g (2.535 lb)

(All specifications are at nominal values, full load, 25°C unless otherwise stated)

### Dimensions

#### SPDC 120W

Unit : mm

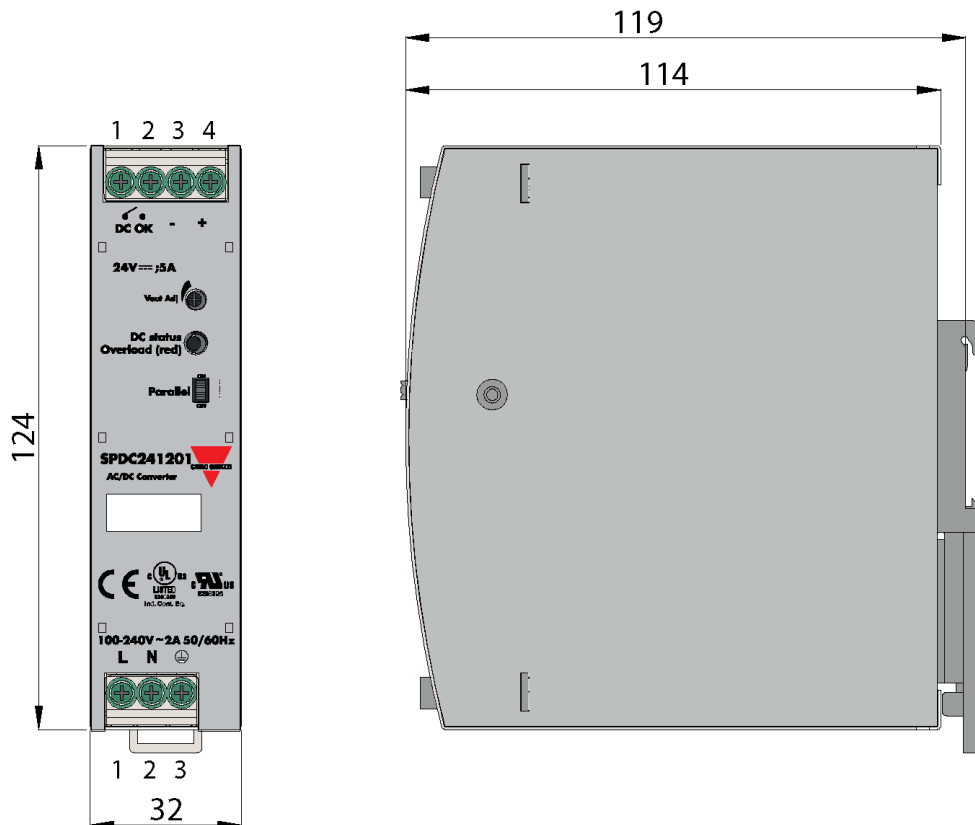

# SPDC



**SPDC 240W**  
Unit: mm

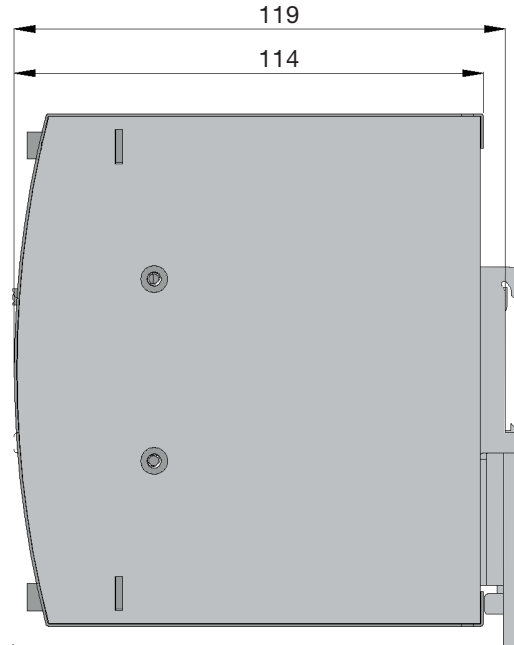
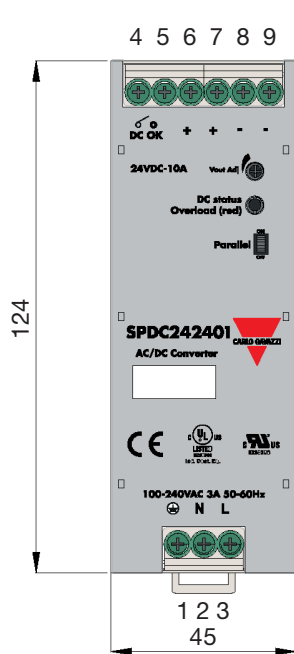

**SPDC 480W**  
Unit: mm

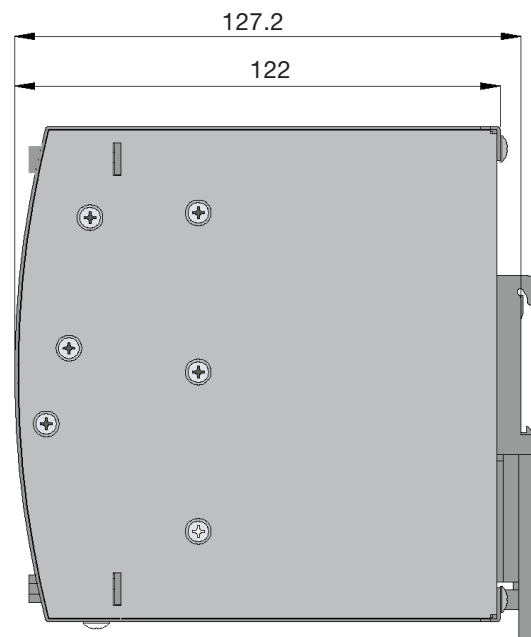
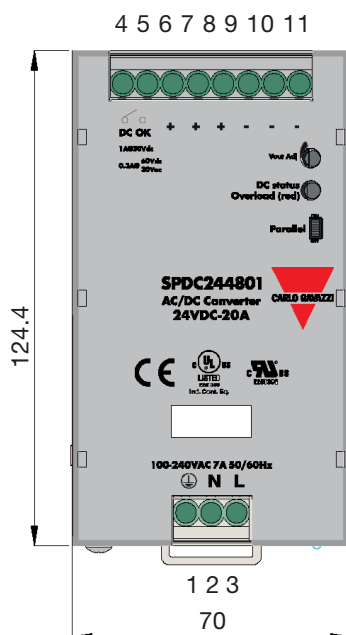

## Connection diagram

### Terminal markings

#### SPDC120W

Terminal	Designation	Description
1	Ground	Ground this terminal to minimize high frequency emissions
2	N	Input terminals (neutral conductor, no polarity with DC input)
3	L	Input terminals (phase conductor, no polarity with DC input)
4	DC OK	DC ON relay contact (Common)
5	DC OK	DC ON relay contact (Normally open contact)
7	V+	Positive output terminal
6	V-	Negative output terminal
	Vout ADJ.	Potentiometer for output voltage adjustment
	DC status	LED indication of power supply output status
	Parallel	Switch for single or parallel operation



#### SPDC240W

Terminal	Designation	Description
1	Ground	Ground this terminal to minimize high frequency emissions
2	N	Input terminals (neutral conductor, no polarity with DC input)
3	L	Input terminals (phase conductor, no polarity with DC input)
4	DC OK	DC ON relay contact (Common)
5	DC OK	DC ON relay contact (Normally open contact)
6, 7	V+	Positive output terminal
8, 9	V-	Negative output terminal
	Vout ADJ.	Potentiometer for output voltage adjustment
	DC status	LED indication of power supply output status
	Parallel	Switch for single or parallel operation



#### SPDC480W

Terminal	Designation	Description
1	Ground	Ground this terminal to minimize high frequency emissions
2	N	Input terminals (neutral conductor, no polarity with DC input)
3	L	Input terminals (phase conductor, no polarity with DC input)
4	DC OK	DC ON relay contact (Common)
5	DC OK	DC ON relay contact (Normally open contact)
6, 7, 8	V+	Positive output terminal
9, 10, 11	V-	Negative output terminal
	Vout ADJ.	Potentiometer for output voltage adjustment
	DC status	LED indication of power supply output status
	Parallel	Switch for single or parallel operation

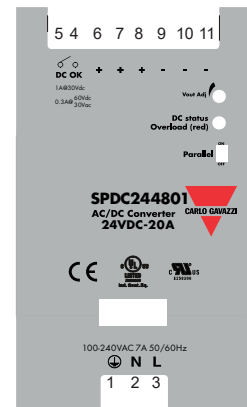

## Environmental

	SPDC 120W	SPDC 240W	SPDC 480W
Operating temperature	-25°C to 70°C -13°F to 158°F		
Storage temperature	-40°C to 85°C -40°F to 185°F		
Humidity	20% to 90% RH No condensing	5% to 90% RH No condensing	
Temperature derating from 60°C to 70°C (140°F to 158°F)	Refer to derating diagram		
Temperature coefficient	+/- 0.03%/°C		

## Compatibility and conformity

	SPDC 120W	SPDC 240W	SPDC 480W
Safety standards	EN60950-1		
EMC emission	EN55022, EN55024, FCC PART 15 Class B		
Harmonic current	EN61000-3-2, Class A		
EMC immunity	EN61000-4-2, EN61000-4-3, EN61000-4-4, EN61000-4-5, EN61000-4-6, EN61000-4-8, EN61000-4-11, Heavy Industrial Level		
UL Certification cULus cURus	UL508 Listed UL60950-1 (2nd Edition)		
Vibration resistance	IEC 60068-2-6		

## Insulation

	SPDC 120W	SPDC 240W	SPDC 480W
Insulation/Withstand Voltage (Input / GND)	2.5kVAC /10mA		
Insulation/Withstand Voltage (Input / Output)	3kVAC /10mA		
Insulation/Withstand Voltage (Output / GND)	0.5kVAC /20mA		
Output / DC OK	0.5KVAC/1mA		
Insulation resistance	≥10MΩ		
Overvoltage Category	II		
Pollution Degree	2		



## Inputs

	SPDC 120W	SPDC 240W	SPDC 480W
Rated input Voltage	100VAC to 240VAC		
Input Voltage range	85VAC to 264VAC 127VDC to 375 VDC		90VAC to 264VAC 130VDC to 350VDC
AC Current (max) 100VAC 230VAC	<1.5A <0.65A	<3A <1.5A	<7A <3.5A
Frequency Range	47Hz to 63Hz		
Inrush current 100VAC 230VAC	<30A <60A	<20A <40A	<20A <40A
Inrush current (DC)	60A	44A	5.3A
Internal input fuse	T5A/250V	T5A/250V	T10A/250V
Standby-Consumption	<2.5W	<3W	<4W

(All specifications are at nominal values, full load, 25°C unless otherwise stated)

## Outputs

	SPDC 120W	SPDC 240W	SPDC 480W
Output Power	120W	240W	480W
Voltage accuracy	±1%	±3%	±3%
Line Regulation	±0.5%		
Load Regulation	±1.0%		
Voltage regulation span	12VDC to 14VDC (12VDC) 24VDC to 28VDC (24VDC)	24VDC to 28VDC (24VDC)	24VDC to 28VDC (24VDC) 48VDC to 56VDC (48VDC)
Rated output current	10A (12VDC) 5A (24VDC)	10A (24VDC)	20A (24VDC) 10A (48VDC)
Ripple and Noise 0 to 70°C (32 to 158°F)  -25 to 0°C (-13 to 32°F)	≤100mV (12VDC) ≤120mV (24VDC)  ≤200mV (12VDC) ≤240mV (24VDC)	≤240mV (24VDC)  ≤480mV (24VDC)	≤240mV (24VDC) ≤480mV (48VDC)  ≤480mV (24VDC) ≤480mV (48VDC)
Hold up Time	≤20ms		
Set-up Time	≤250ms	≤3s	
Rise Time	≤23ms	≤26ms	≤30ms
Turn-on overshoot	≤5.0%		
Overshoot and Undershoot	≤5.0%		
Series Operation	Yes		
Parallel Operation	Max 2 identical units		
Power Boost	150% of rated output current		

(All specifications are at nominal values, full load, 25°C unless otherwise stated)

## Performance

### Current derating

#### SPDC 120W 12VDC

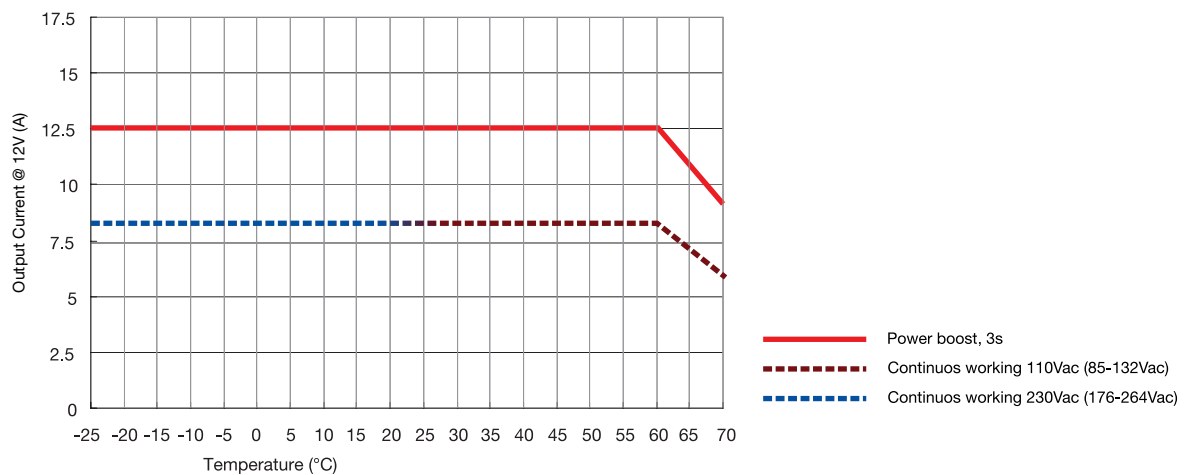
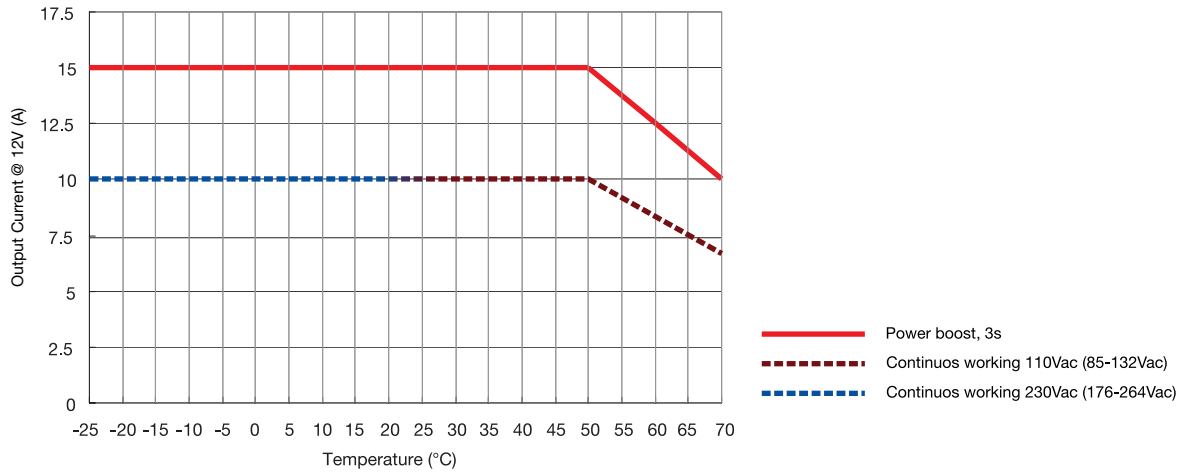

#### SPDC 120W 24VDC

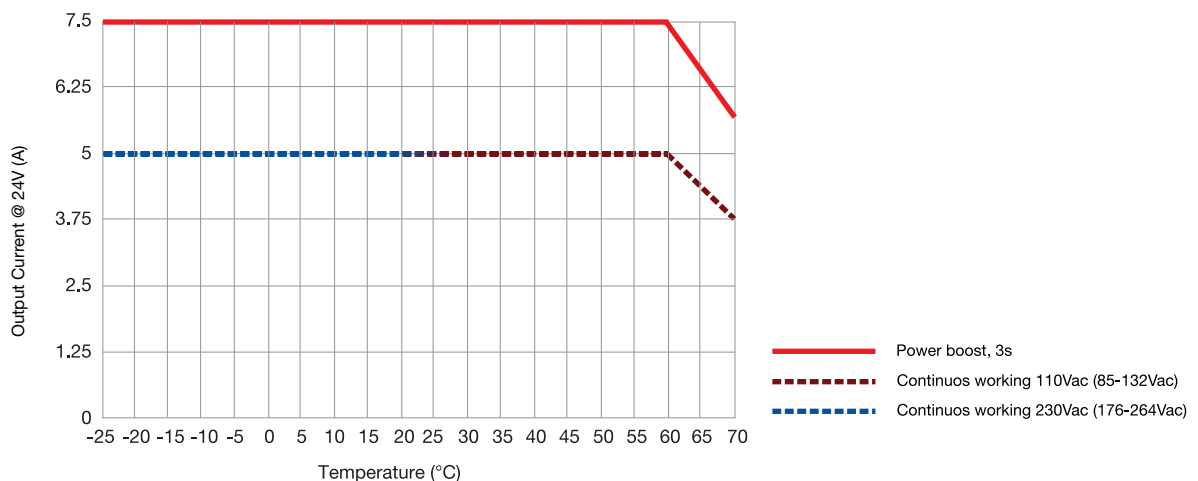

## SPDC 240W 24VDC

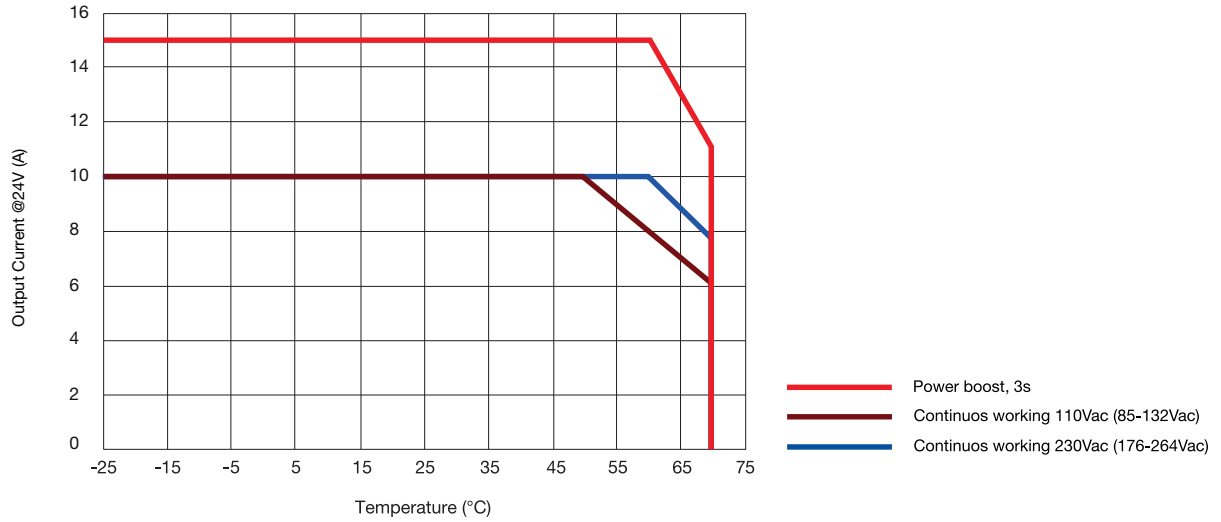

## SPDC 480W 24VDC

Output Current Vs Ambient Temp.

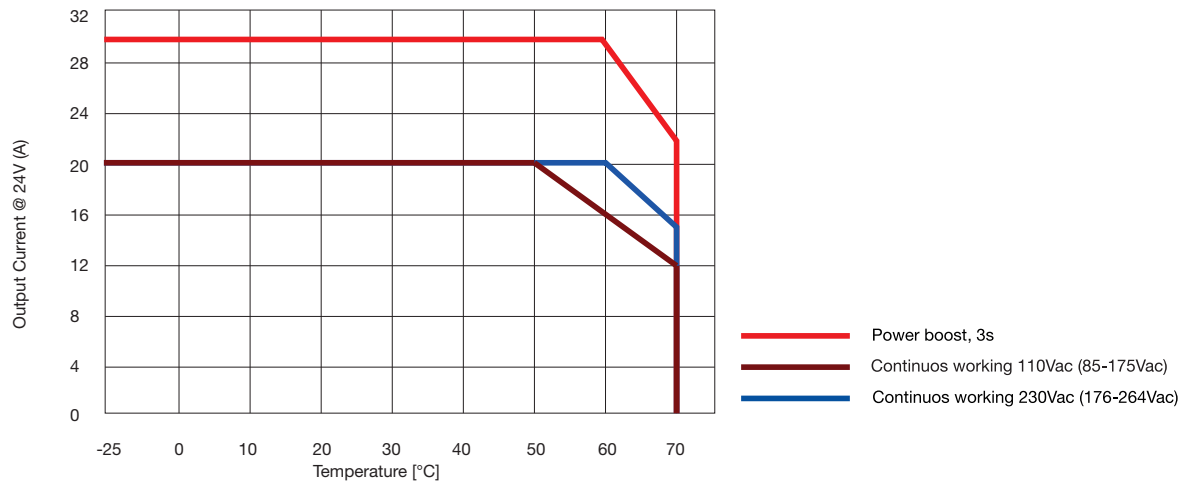

## SPDC 480W 48VDC

Output Current Vs Ambient Temp.

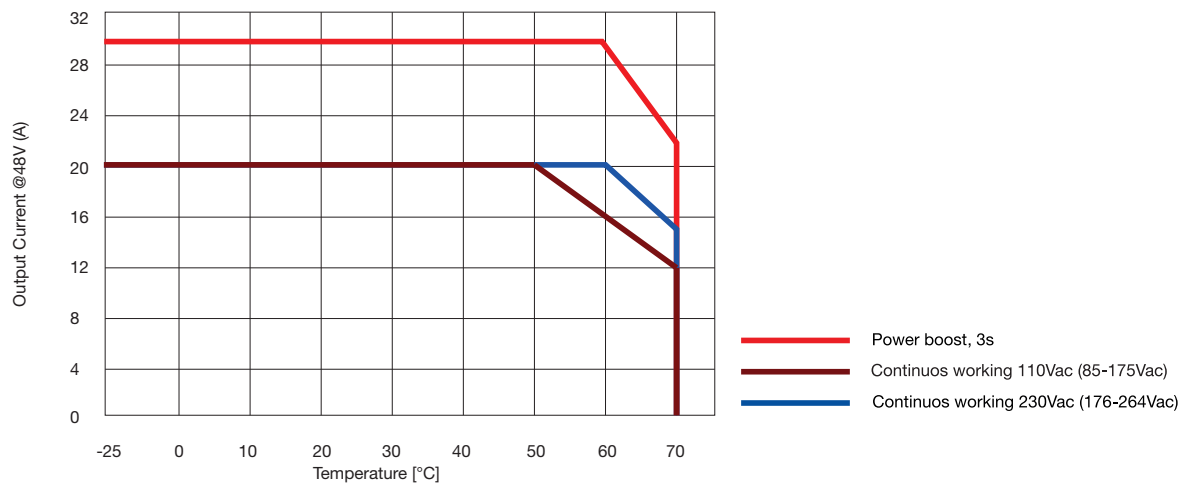

## Installation

	SPDC 120W	SPDC 240W	SPDC 480W
Ventilation and Cooling	Normal air convection; 25mm of free space on each side is recommended		

### Mounting method instruction

A1 is recommended output current, A2 is the allowed max output current (PSU lifetime is around half of A1)

#### 120W 12VDC

#### 120W 24VDC

Mounting A

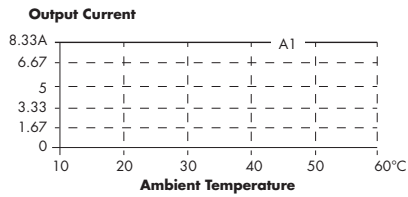
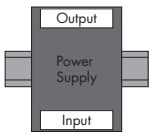

Mounting A

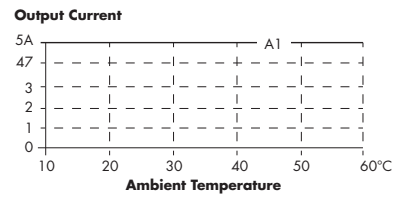
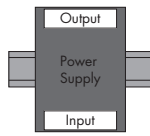

Mounting B

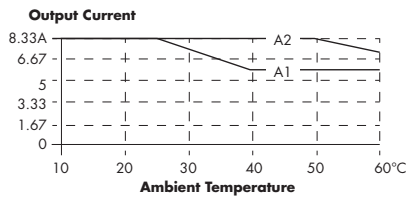
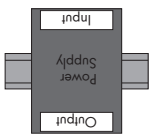

Mounting B

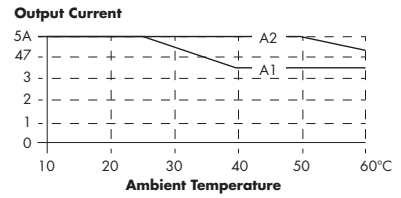
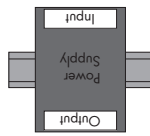

Mounting C

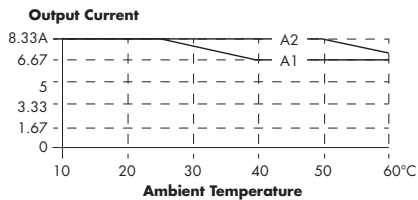
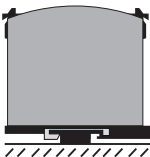

Mounting C

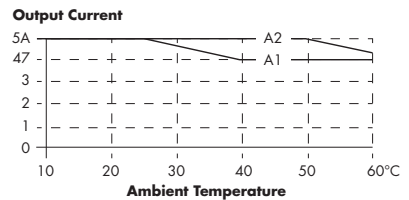
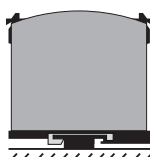

Mounting D

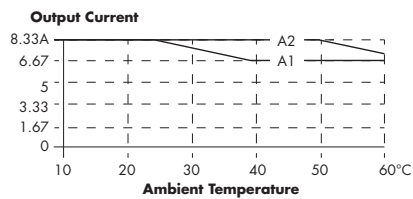
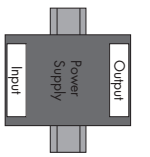

Mounting D

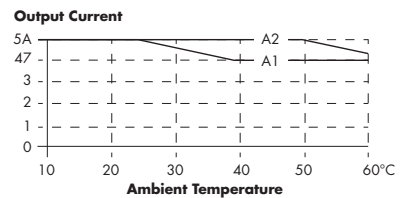
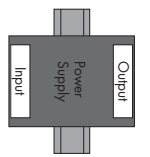

Mounting E

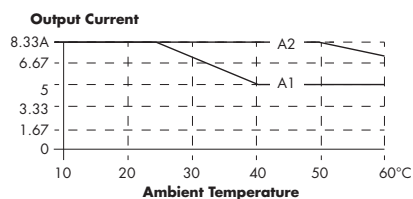
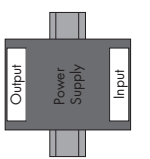

Mounting E

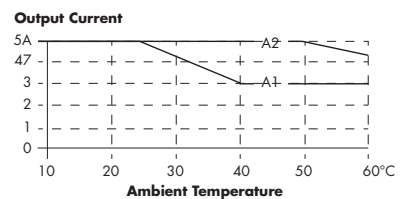
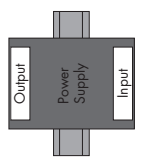

## Installation

### Mounting method instruction

A1 is recommended output current, A2 is the allowed max output current (PSU lifetime is around half of A1). Below curves are tested under 230Vac (179~264Vac), when 110Vac input (85~175Vac), all derating points drops 10°C

### 240W 24VDC

Mounting A

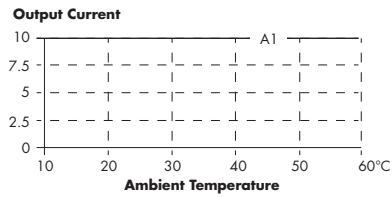
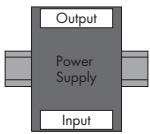

Mounting B

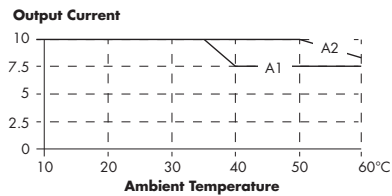
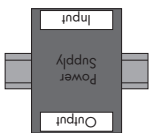

Mounting C

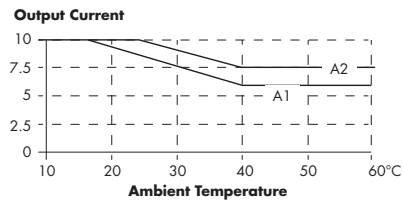
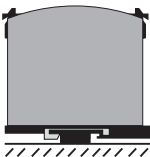

Mounting D

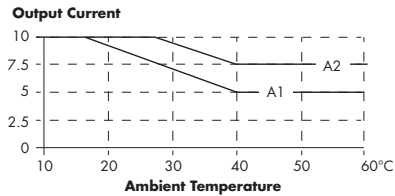
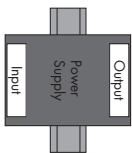

Mounting E

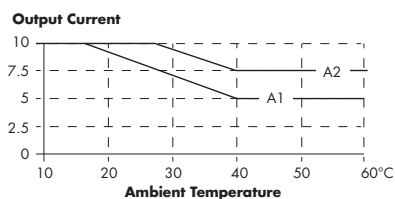
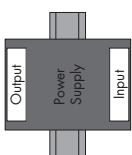

## Installation

### Mounting method instruction

A1 is recommended output current, A2 is the allowed max output current (PSU lifetime is around half of A1). Below curves are tested under 230Vac (179~264Vac), when 110Vac input (85~175Vac), all derating points drops 10°C

#### 480W 24VDC

Mounting A

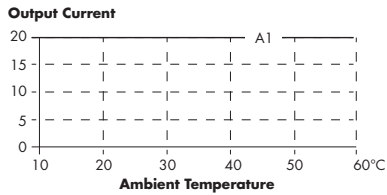
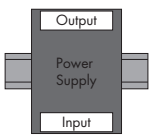

Mounting B

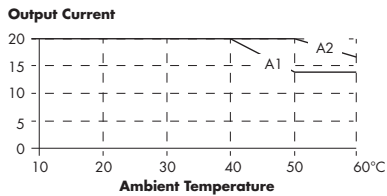
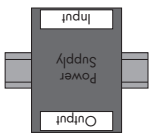

Mounting C

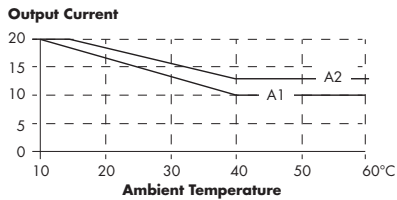
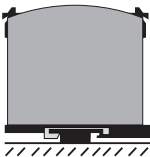

Mounting D

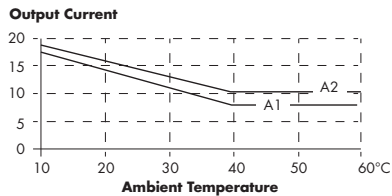
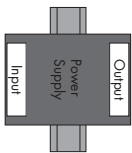

Mounting E

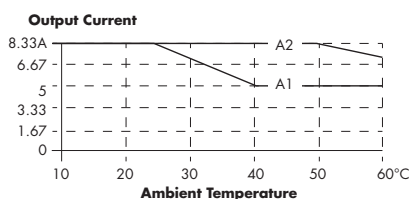
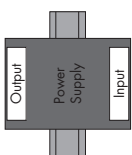

#### 480W 48VDC

Mounting A

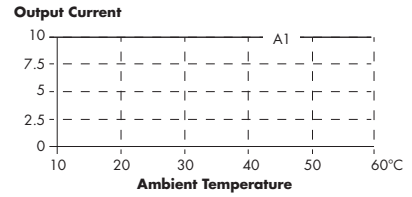
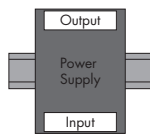

Mounting B

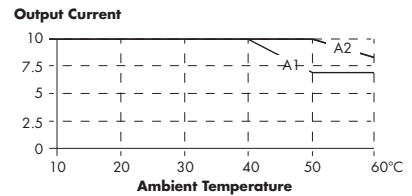
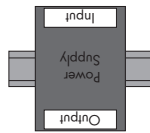

Mounting C

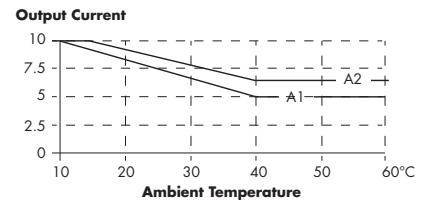

Mounting D

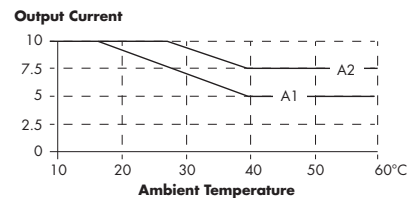
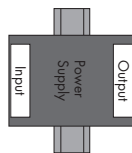

Mounting E

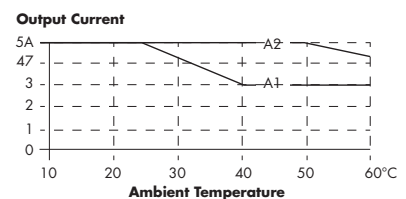
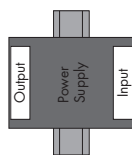

## Wiring diagram

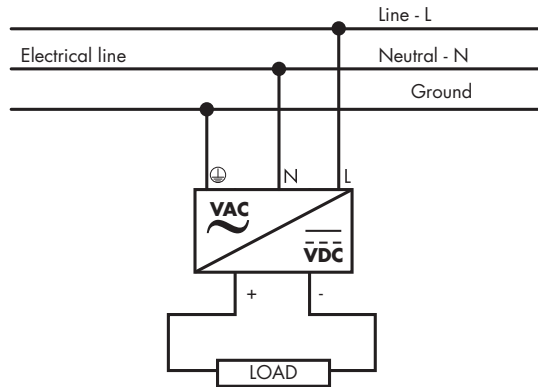

## Connection specification

	SPDC 120W	SPDC 240W	SPDC 480W
Terminal type	Input: 6.35mm 3PIN screw terminals		
Screw driver blade	3.5mm slotted or cross screwdriver		
Tightening torque (Recommended)	1Nm		
Flexible conductor Cross section Max	4mm <sup>2</sup>		
Flexible conductor Cross section Min	0.5mm <sup>2</sup>		
Conductor Cross section AWG Max	AWG20 (GND wire >18AWG)		
Conductor Cross section AWG Min	AWG10 (GND wire >18AWG)		
Rigid conductor Cross-section Min	6mm <sup>2</sup>		
Rigid conductor Cross-section Max	0.5mm <sup>2</sup>		
Max Wire Diameter	2.8mm <sup>2</sup>		

## Block diagram

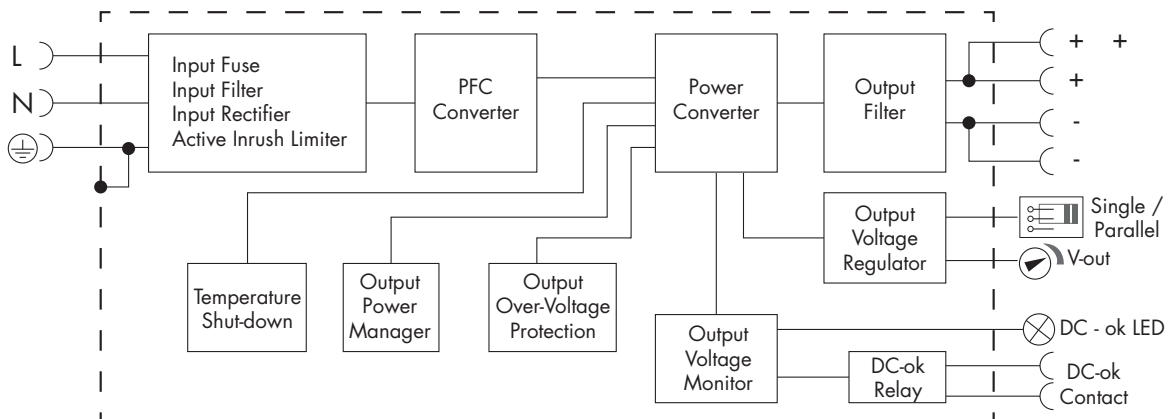

## Troubleshooting

### ▶ Signaling and controls

	SPDC 120W	SPDC 240W	SPDC 480W
DC OK LED	Bicolour LED: Green-OK, Red-Fault		
DC OK output type	Normally Open contact		
Voltage free contact	Yes		
DC contact rating	Max 30V/1A or 60V/0.3A (DC1)		
AC contact rating	Max 30V/0.3A Resistive load (AC1)		
OK threshold	≥ 90% of rated output voltage		
Not OK threshold	≤ 80% of rated output voltage		

## Operating description

### ▶ Control and protection

	SPDC 120W	SPDC 240W	SPDC 480W
Overvoltage protection	15-18VDC (12VDC) 29-33VDC (24VDC)	29-33VDC (24VDC)	28.8-33VDC (24VDC) 58-63VDC (48VDC)
Overload protection 100% ~ 150% of rated current >150% of rated current	Constant current limiting for some time (150% of rated current, last 3s) Hiccup mode, auto recovery: PS stop working for 7s, after 7s, if the load ≤ rated current, PS will work normally, auto recovery		
Current Limiting	Constant Current limiting		
Short Circuit protection	Long term mode. Auto recovery		
Over temperature protection	105±5°C (221±41°F), detect on temperature controller; shut down O/P, auto recovery after temperature goes down		
Reverse voltage protection	No		



## Glossary



**CE:** "Conformité Européene" or "European Conformity" ; Indicates the manufacturer declaration of conformity that the product meets the relevant health, safety and environmental protection requirements of the applicable EC directives.



**cULus:** This certification mark is based on the UL508 ; Standard for Industrial Control Equipment. The UL508 covers industrial control devices and devices accessory for starting, stopping, regulating, controlling, or protecting electric motors. In addition, UL508 also covers devices rated 1500 volts or less. Industrial control equipment covered by these requirements is intended for use in an ambient temperature of 0 – 40°C (32 – 104°F)



**cRUus:** This certification mark is based on the UL60950-1 ; Information Technology Equipment - Safety - Part 1. The UL60950-1 is applicable to mains-powered or battery-powered information technology equipment, including electrical business equipment and associated equipment, with a RATED VOLTAGE not exceeding 600 V.

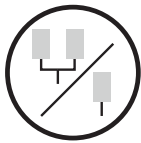

**Parallel Operation:** Enable the use of 2 identical Power Supply units to be connected in Parallel to double the output current.



**Power Boost:** Increase the power output between 110% to 150% for a short period of time to sustain the initial load operations.

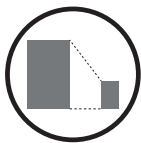

**Compact dimension:** The footprint is greatly reduced with this range, saving up to 50% space when compared to others.

## X-ON Electronics

Largest Supplier of Electrical and Electronic Components

*Click to view similar products for [DIN Rail Power Supplies](#) category:*

*Click to view products by [Carlo Gavazzi](#) manufacturer:*

Other Similar products are found below :

[PS-S6024](#) [DVP01PU-S](#) [DVP06AD-S](#) [DVP06XA-S](#) [DVDPNET-SL](#) [DVPDT01-S](#) [DVPPS01](#) [PS-6012](#) [PS9Z-5R1G](#) [PS-C24024](#)  
[DVP08ST11N](#) [DVPACAB530](#) [DVPCOPM-SL](#) [DVPEN01-SL](#) [DVPPF01-S](#) [ADNB008-48-1PM-C](#) [ADNB017-24-1PM-C](#) [ADNB040-24-1PM-C](#) [ADNB050-12-1PM-C](#) [ADNB040-15-1PM-C](#) [ADNB034-12-1PM-C](#) [S8TS-06024-E1](#) [PS-UPS40](#) [PSC-6024](#) [PSD-A60W12](#) [96PS-A120WDIN](#) [PSD-A60W48](#) [PSD-A40W12](#) [PSD-A40W24](#) [SMP21-L20-DC24V-5A](#) [PSD-A40W48](#) [S8T-DCBU-02](#) [PS-S4024](#) [NTPS-24-1.3](#)  
[PST-96024](#) [S82YVSC4P](#) [PS-S4005](#) [PS-10024](#) [PS-S10024](#) [PS-C12024](#) [PSP-480S24](#) [PS-C48024](#) [PSC-2024](#) [PSC-4012](#) [PSC-4015](#) [PSC-4048](#)  
[PSC-9615](#) [PSC-15124](#) [PSC-15148](#) [PSC-24148](#)