

SPDM



Single Phase Power Supply



Benefits

- **Power in compact dimensions.** The SPDM provide up to +30% space saving when compared to SPD
- **Reliable and cost saving.** The SPDM provide high reliability power at an attractive price level
- **Low power loss, high efficiency.** The compact design results in low energy losses and high efficiency
- **Intuitive indication.** A clear LED indicate the status of the power supply
- **Universal AC, DC input range.** SPDM Series can be powered with AC Voltage (85VAC to 264VAC) or with DC Voltage (130VDC to 350VDC).
- **Reliable critical protection.** The operation safety is guaranteed by the various output protections: Over Voltage (OVP), Over Load (OLP), Short Circuit (SCP) and Over Temperature (OTP).
- **High efficiency and wide operating ambient temperature.** These power supplies have an efficiency up to 88%.
- **Ease of installation.** The SPDM can be installed in 5 different orientations, enabling the unit to fit easily into installations with limited space.

Description

The SPDM is designed to be used in all automation applications, where it can be easily installed on the Din Rail and save installation time by up to 50% with the option of the spring terminal. The SPDM is a premium quality product at a attractive price level. Reliability is guaranteed through the multiple integrated protections.

Applications

This product is extremely suitable for all applications which require single-phase power supply with universal voltage input and high efficiency.

Main functions

- Compact dimension of up to 45mm width
- High efficiency up to 88%
- Universal input voltage range: 85VAC to 264VAC; 130VDC to 350VDC
- 30W, 50W, 75W, 120W, 240W
- Screw or Spring terminals

References

Order code



SPDM 1

Enter the code entering the corresponding option instead of

| Code | Option | Description | Notes |
|--------------------------|--------|--------------------|----------------------|
| S | - | Switching | Device typology |
| P | - | Power | |
| D | - | DIN rail | |
| M | - | Medium | Size |
| <input type="checkbox"/> | 12 | 12VDC | Rated output voltage |
| | 24 | 24VDC | |
| | 48 | 48VDC | |
| <input type="checkbox"/> | 30 | 30W | Rated output power |
| | 50 | 50W | |
| | 75 | 75W | |
| | 120 | 120W | |
| | 240 | 240W | |
| 1 | - | Single phase input | Input type |
| | B | Spring terminal | Terminal type |

Selection guide

| Output Voltage | 30W | 50W | 75W | 120W | 240W |
|----------------|-------------|-------------|-------------|------------|------------|
| 12VDC | SPDM12301/B | SPDM12501/B | SPDM12751/B | SPDM121201 | - |
| 24VDC | SPDM24301/B | SPDM24501/B | SPDM24751/B | SPDM241201 | SPDM242401 |
| 48VDC | - | - | - | SPDM481201 | SPDM482401 |

Further reading

| Information | Where to find it | QR |
|-------------------------|---|----|
| SPDM DatasheetSheet | http://www.productselection.net/Pdf/UK/PS_SPDM_DS.pdf | |
| SPDM Installation Sheet | http://www.productselection.net/MANUALS/UK/PS_SPDM_IM.pdf | |
| SPDM CAD drawings | http://www.productselection.net/DXF/PS_SPDM.zip | |

SPDM

Structure

SPDM 30W

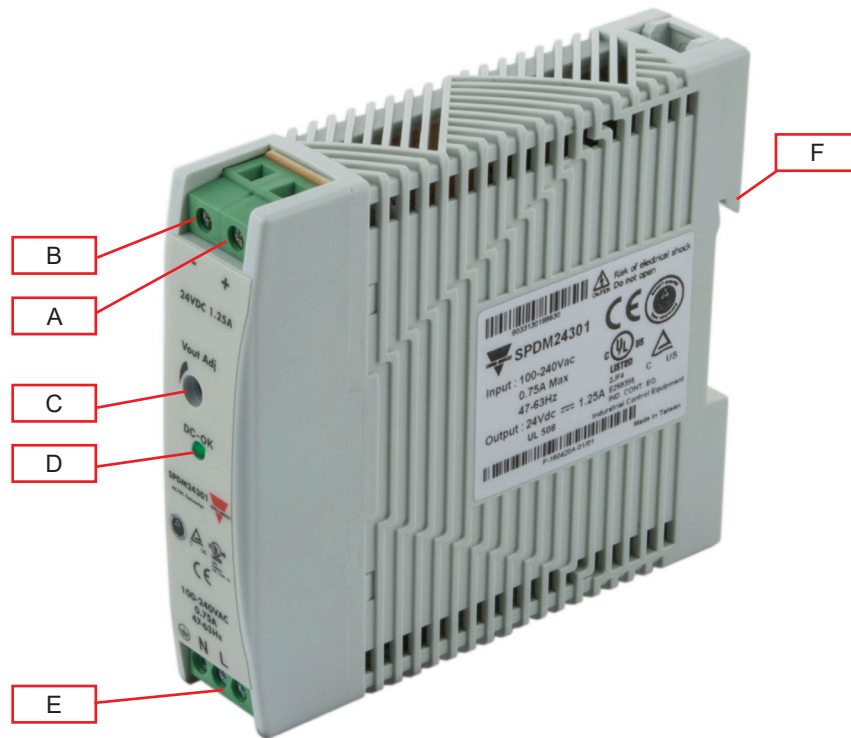

SPDM 50W

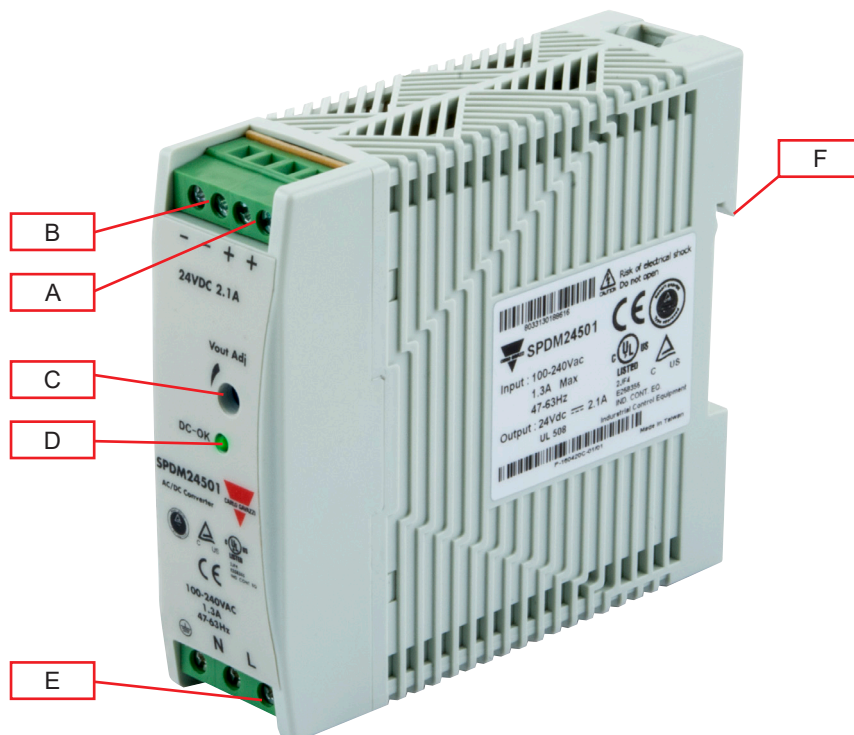

SPDM



SPDM 75W

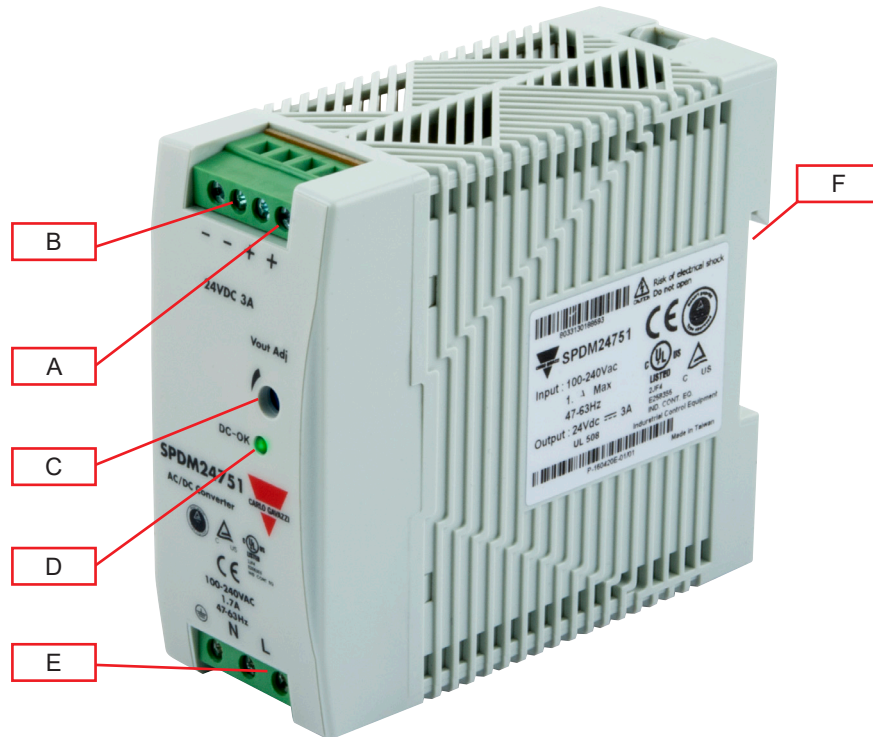

| SPDM 30W / SPDM 50W / SPDM 75W | | |
|--------------------------------|------------------------|--|
| Element | Component | Function |
| A | + V terminals | Positive DC Output terminals |
| B | - V terminals | Negative DC Output terminals |
| C | VADJ Trimmer | Output voltage adjustment |
| D | DC OK LED | Green when output voltage $\geq 90\%$ of rated output voltage Red when output voltage $\leq 80\%$ of rated output voltage, or, Overload |
| E | Power supply terminals | L, N supply terminals + GND |
| F | DIN rail mounting clip | Clip present on back side |

SPDM



SPDM 120W

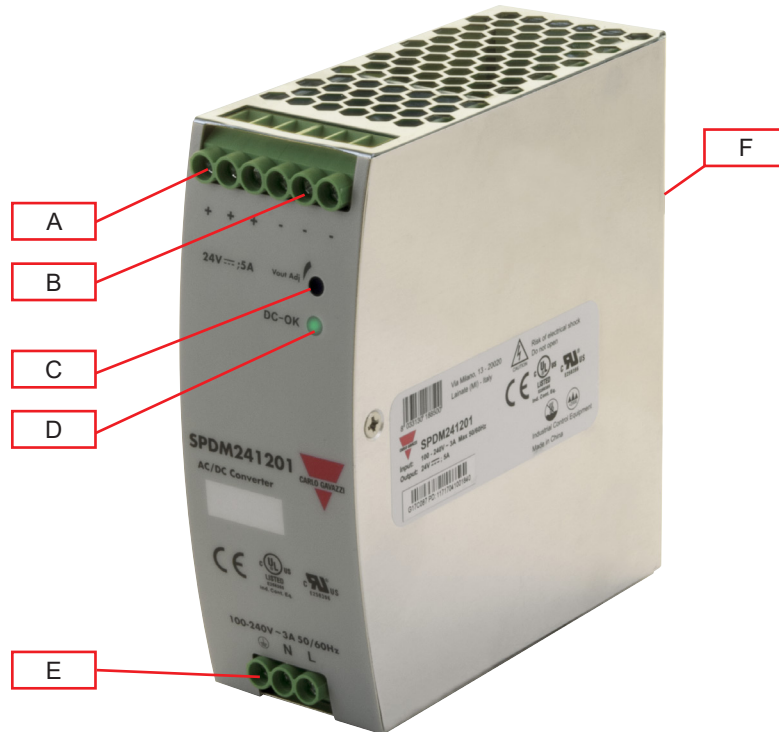

SPDM 240W

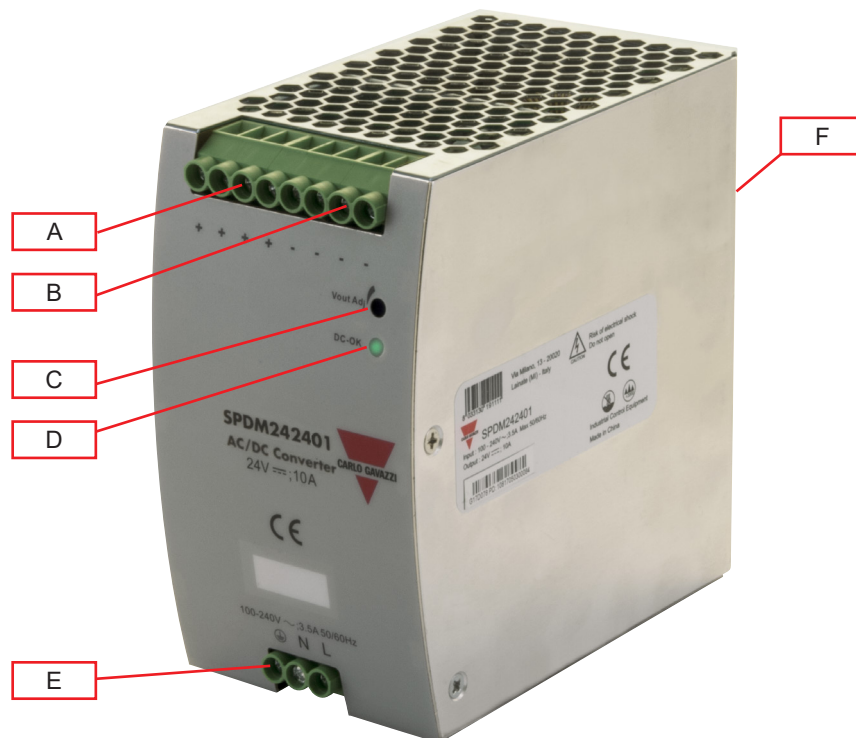

| SPDM 120W / SPDM 240W | | |
|-----------------------|------------------------|--|
| Element | Component | Function |
| A | + V terminals | Positive DC Output terminals |
| B | - V terminals | Negative DC Output terminals |
| C | VADJ Trimmer | Output voltage adjustment |
| D | DC OK LED | Green when output voltage $\geq 90\%$ of rated output voltage Red when output voltage $\leq 80\%$ of rated output voltage, or, Overload |
| E | Power supply terminals | L, N supply terminals + GND |
| F | DIN rail mounting clip | Clip present on back side |

Features

General data

| | SPDM 30W | SPDM 50W | SPDM 75W | SPDM 120W | SPDM 240W |
|--|---|---|---|---|--------------------------------|
| Leakage current | <0.25mA (Input-Output) | | | | |
| Earth leakage current | <3.5mA (Input-GND) | | | | |
| Efficiency | 86% | 87% | 87% | 85% (12VDC) 88% (24VDC) 89% (48VDC) | 87% (24VDC) 88% (48VDC) |
| Power loss @ nominal load | 4.9W (12VDC) 5.7W (24VDC) | 8.0W (12VDC) 8.8W (24VDC) | 10.5W (12VDC) 10.5W (24VDC) | 16W @ 120W | 35W @ 240W |
| Power Factor (Full Load) 110VAC 230VAC | - | - | - | - | 0.98 0.94 |
| Ingress Protection | IP20 | | | | |
| MTBF | 721,000Hrs (12V) 764,000Hrs (24V) Bellcore Issue 6 @40°C, GB | 556,000Hrs (12V) 580,000Hrs (24V) Bellcore Issue 6 @40°C, GB | 556,000Hrs (12V) 580,000Hrs (24V) Bellcore Issue 6 @40°C, GB | >500,000Hrs (MIL-HDBK-217F) | >300,000Hrs (MIL-HDBK-217F) |
| Case material | Plastic | | | Metal | |
| Weight | 140g | 200g | 250g | 590g | 940g |
| Switching Frequency | 65kHz | | 40 to 100kHz | 80KHz | 75z |
| Mounting | DIN rail mounting | | | | |
| Packing | 0.15Kg; 60 pcs / 10Kg / 2.16cuft | 0.22Kg; 48 pcs / 12Kg / 2.16cuft | 0.27Kg; 40 pcs / 12Kg / 2.16cuft | 24pcs/CTN, 15.0Kg, 0.04cbm | 10pcs/CTN, 11.5Kg, 0.04cbm |

(All specifications are at nominal values, full load, 25°C unless otherwise stated)

SPDM



Dimensions

SPDM 30W
Unit: mm

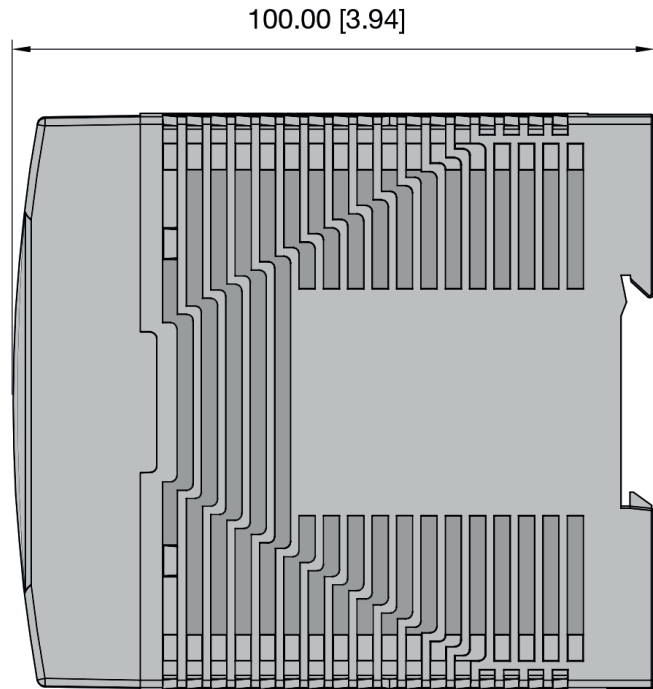
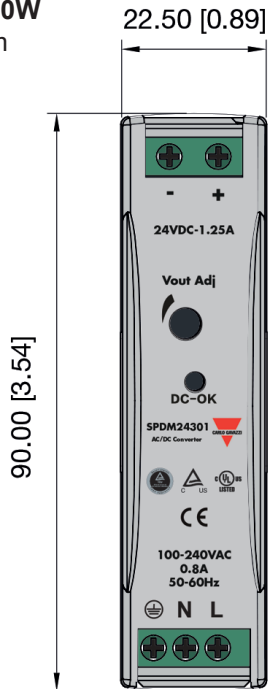

SPDM 50W
Unit: mm

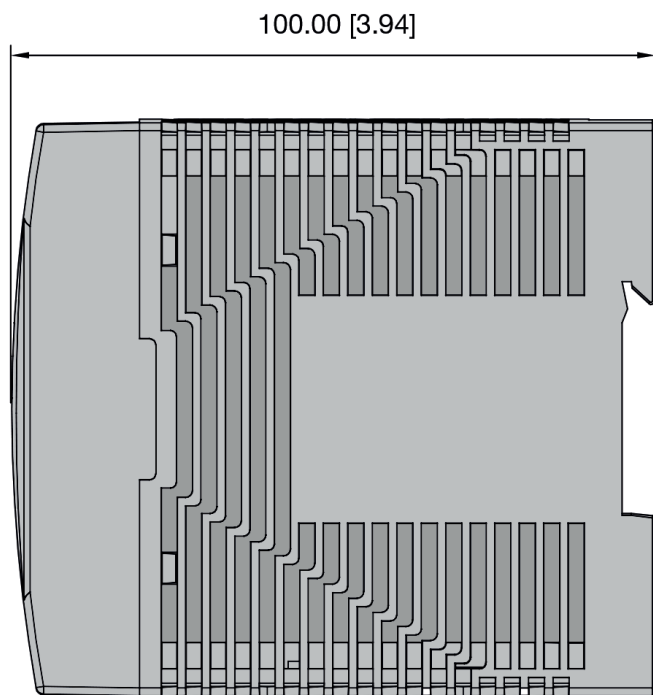
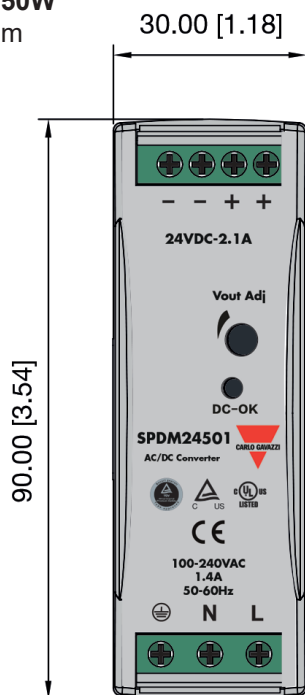

SPDM



SPDM 75W
Unit: mm

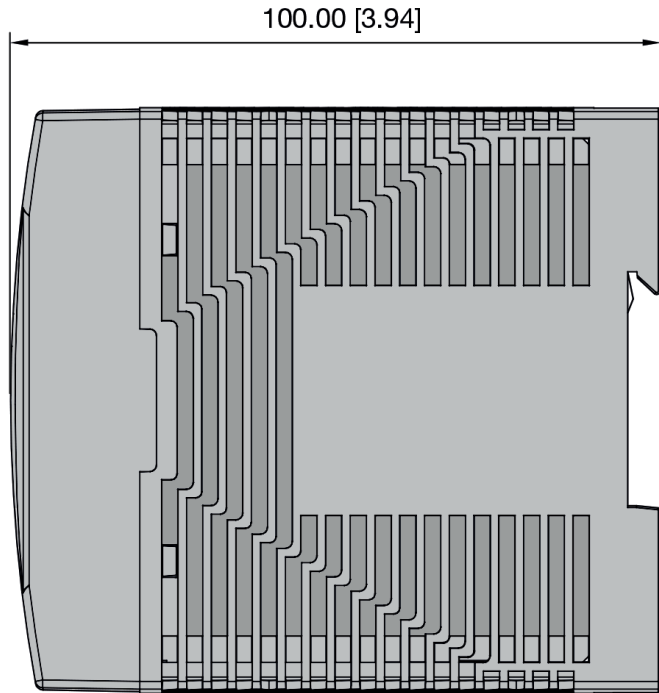
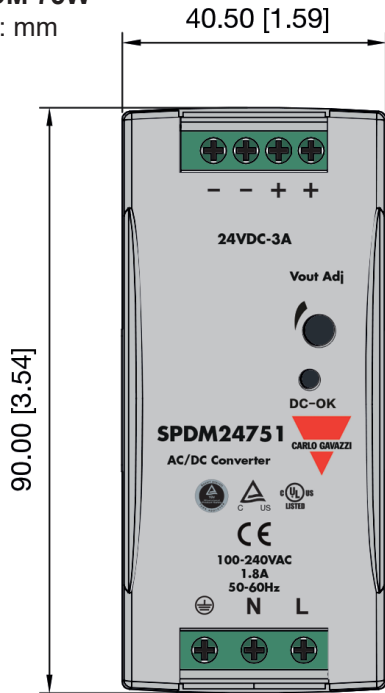

SPDM 120W
Unit: mm

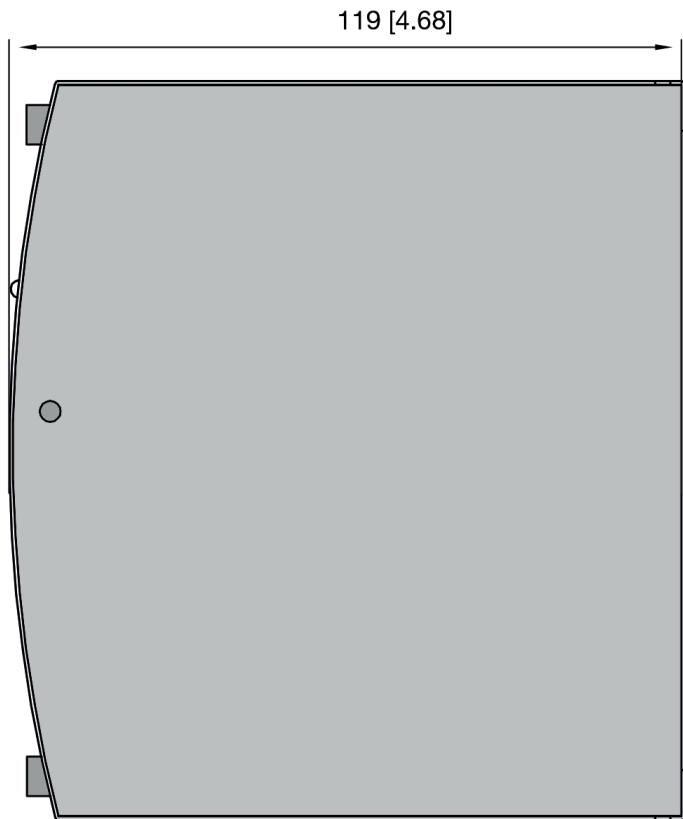
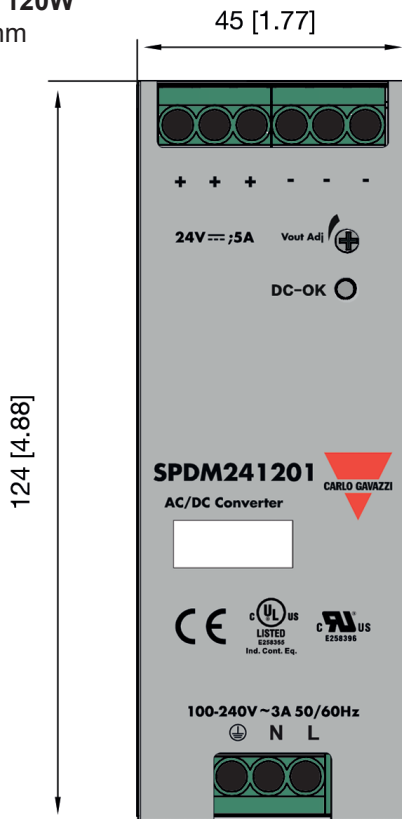

SPDM



SPDM 240W

Unit: mm

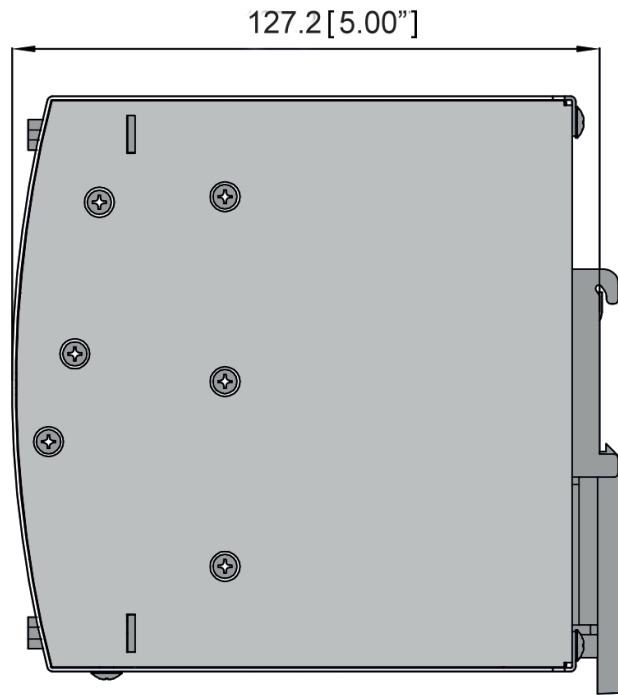
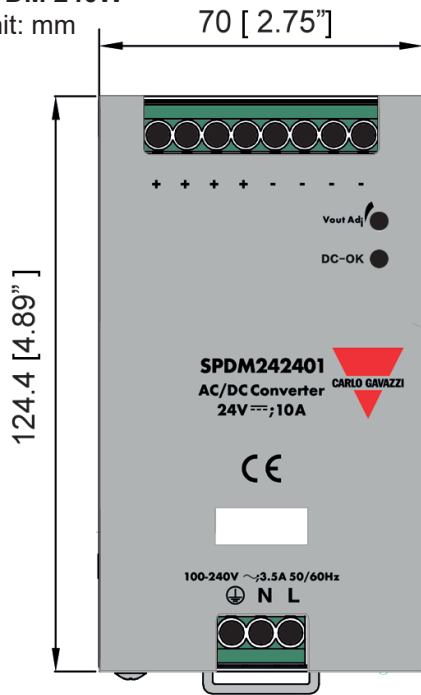

Connection diagram

Terminal markings

SPDM 30W

| Terminal | Designation | Description |
|----------|-------------|--|
| 1 | Ground | Ground this terminal to minimize high frequency emissions |
| 2 | N | Input terminals (neutral conductor, no polarity with DC input) |
| 3 | L | Input terminals (phase conductor, no polarity with DC input) |
| 4 | V+ | Positive output terminal |
| 5 | V- | Negative output terminal |
| | Vout ADJ. | Potentiometer for output voltage adjustment |
| | DC status | LED indication of power supply output status |



SPDM 50W

| Terminal | Designation | Description |
|----------|-------------|--|
| 1 | Ground | Ground this terminal to minimize high frequency emissions |
| 2 | N | Input terminals (neutral conductor, no polarity with DC input) |
| 3 | L | Input terminals (phase conductor, no polarity with DC input) |
| 4, 5 | V+ | Positive output terminal |
| 6, 7 | V- | Negative output terminal |
| | Vout ADJ. | Potentiometer for output voltage adjustment |
| | DC status | LED indication of power supply output status |



SPDM 75W

| Terminal | Designation | Description |
|----------|-------------|--|
| 1 | Ground | Ground this terminal to minimize high frequency emissions |
| 2 | N | Input terminals (neutral conductor, no polarity with DC input) |
| 3 | L | Input terminals (phase conductor, no polarity with DC input) |
| 4, 5 | V+ | Positive output terminal |
| 6, 7 | V- | Negative output terminal |
| | Vout ADJ. | Potentiometer for output voltage adjustment |
| | DC status | LED indication of power supply output status |



SPDM



SPDM 120W

| Terminal | Designation | Description |
|----------|-------------|--|
| 1 | Ground | Ground this terminal to minimize high frequency emissions |
| 2 | N | Input terminals (neutral conductor, no polarity with DC input) |
| 3 | L | Input terminals (phase conductor, no polarity with DC input) |
| 4, 5, 6 | V+ | Positive output terminal |
| 7, 8, 9 | V- | Negative output terminal |
| | Vout ADJ. | Potentiometer for output voltage adjustment |
| | DC status | LED indication of power supply output status |

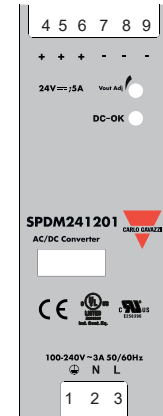

SPDM 240W

| Terminal | Designation | Description |
|--------------|-------------|--|
| 1 | Ground | Ground this terminal to minimize high frequency emissions |
| 2 | N | Input terminals (neutral conductor, no polarity with DC input) |
| 3 | L | Input terminals (phase conductor, no polarity with DC input) |
| 4, 5, 6, 7 | V+ | Positive output terminal |
| 8, 9, 10, 11 | V- | Negative output terminal |
| | Vout ADJ. | Potentiometer for output voltage adjustment |
| | DC status | LED indication of power supply output status |

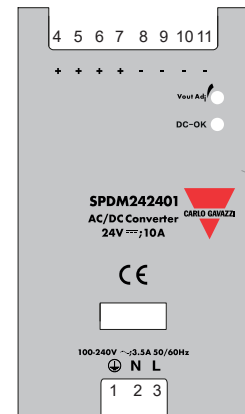

Environmental

| | SPDM 30W | SPDM 50W | SPDM 75W | SPDM 120W | SPDM 240W |
|-----------------------------|-----------------------------------|----------|----------|--------------------------------|-----------|
| Temperature operating range | -25°C to 71°C -13°F to 159.8°F | | | -20°C to 70°C -4°F to 158°F | |
| Temperature storage | -40°C to 85°C -40°F to 185°F | | | | |
| Humidity | 20% to 95% RH No condensing | | | 20% to 90% RH No condensing | |
| Temperature derating | Refer to derating diagrams | | | | |
| Temperature regulation | +/- 0.03%/°C | | | | |

Compatibility and conformity

| | SPDM 30W | SPDM 50W | SPDM 75W | SPDM 120W | SPDM 240W |
|--|---|----------|---|--|--|
| Safety Standards | EN60950-1 | | | | |
| EMC Emission | EN61000-6-3:2007+A1:2011+AC:2012 EN61204-3:2000 | | | EN55022, EN55024, FCC PART 15 Class B | EN55022, EN55024, Class B |
| Harmonic current | EN 61000-3-2 | | | EN61000-3-2, Class A | |
| EMC immunity | EN 61000-6-2: 2005+AC: 2005 EN 61204-3: 2000 EN55024:2010+A1: 2015 | | | EN61000-4-2, EN61000-4-3, EN61000-4-4, EN61000-4-5, EN61000-4-6, EN61000-4-11, Heavy Industrial Level | |
| CE | EN61000-6-3, EN55032 Class B, EN61000-3-2, EN61000-3-3 EN61000-6-2, EN55024, EN61000-4-2 Level 4, EN61000-4-3 Level 3 EN61000-4-4 Level 4, EN61000-4-5 L-N Level 3, L / N-FG Level 4 EN61000-4-6 Level 3, EN61000-4-8 Level 4, EN691000-4-11 ENV 50204 Level 2, EN61204-3 | | | EN55022, EN55024, FCC PART 15 CLASS B | EN55022, EN55024, FCC PART 15 CLASS B |
| UL Certification cULus cURus UL1310 | UL508 Listed UL60950-1 (2nd Edition) Class 2 | | UL508 Listed UL60950-1 (2nd Edition) Class 2 only for 24VDC models (SPDM24751 and SPDM24751B) | UL508 Listed UL60950-1 (2nd Edition) | - |
| Vibration resistance | IEC 60068-2-6 | | | IEC 60068-2-6 | IEC 60068-2-6 |
| Shock resistance | IEC 60068-2-27 | | | IEC 60068-2-27 | IEC 60068-2-27 |

Insulation

| | SPDM 30W | SPDM 50W | SPDM 75W | SPDM 120W | SPDM 240W |
|-------------------------------------|-----------------------------|----------|----------|-----------------|-----------|
| Insulation/Withstand Voltage (I/PE) | 3000VAC / 4242VDC | | | 3kVAC , ≤10mA | |
| Insulation/Withstand Voltage (I/O) | 1500VAC / 2121VDC | | | 1.5kVAC , ≤10mA | |
| Insulation/Withstand Voltage (O/PE) | 500VAC / 710VDC | | | 0.5kVAC , ≤10mA | |
| Insulation resistance | 100MΩ Input-Output @ 500VDC | | | 10MΩ | |
| Overvoltage Category | Level OVC II | | | II | |
| Pollution Degree | 2 | | | | |

Input Data

| | SPDM 30W | SPDM 50W | SPDM 75W | SPDM 120W | SPDM 240W |
|--------------------------------------|-------------------------------------|-----------------|-----------------|-------------------------------------|--|
| Rated Input Voltage | 100VAC to 240VAC | | | | |
| Input voltage range | 85VAC to 264VAC 120VDC to 375VDC | | | 90VAC to 264VAC 127VDC to 370VDC | |
| AC Current (max) 115VAC 230VAC | 335mA 210mA | 1000mA 500mA | 1450mA 750mA | <2.7A <1.35A | <3A (24VDC), <3.5A (48VDC) <2.5A (24VDC), <2.5A (48VDC) |
| Frequency Range | 47Hz to 63Hz | | | | |
| Inrush current 115VAC 230VAC | <20A <40A | <30A <60A | <30A <60A | <20A <35A | <30A <60A |
| Inrush current (DC) | 50A @ 375Vdc | 70A @ 375Vdc | / | | |
| Internal input fuse | T2A/250VAC | T2A/250VAC | T3.15A/250VAC | 4A/250Vac | T6.3A/250V |
| Standby Power Consumption | 0.3W | | 0.5W | <5W | |

(All specifications are at nominal values, full load, 25°C unless otherwise stated)

Output Data

| | | SPDM 30W | SPDM 50W | SPDM 75W | SPDM 120W | SPDM 240W |
|---|----|--|----------------------------|----------------------------|---|--|
| Output Power | | 30W | 50W | 75W | 120W | 240W |
| Voltage accuracy | | ±1% | | | | |
| Line Regulation | | ±1% | | | ±0.5% | |
| Load Regulation | | ±1% | | | | |
| Voltage regulation span | | 11.4VDC to 15.6VDC (12VDC) 22.5VDC to 28.5VDC (24VDC) | | | 12VDC to 14VDC (12VDC) 24VDC to 28VDC (24VDC) 48VDC to 56VDC (48VDC) | 24VDC to 28VDC (24VDC) 48VDC to 56VDC (48VDC) |
| Rated output current | | 2A (12VDC) 1.25A (24VDC) | 4A (12VDC) 2.1A (24VDC) | 5.5A (12VDC) 3A (24VDC) | 10A (12V) 5A (24V) 2.5A (48DC) | 10A (24V) 5A (48DC) |
| Rated continuous loading | 12 | 1.6 A (15 VDC) | 3.2 A (15 VDC) | 4.4 A (15 VDC) | 9 A (14 VDC) | |
| | 24 | 1 A (28.5 VDC) | 1.7 A (28.5 VDC) | 2.4 A (28.5 VDC) | 4.5 A (28 VDC) | 9 A (28 VDC) |
| | 48 | | | | 2.25 A (56 VDC) | 4.5 A (56 VDC) |
| Ripple and Noise | | 100mV | | | 0 to 70°C (32 to 158°F) ≤120mV (12-24VDC) ≤240mV (48VDC) -20 to 0°C (-13 to 32°F) ≤240mV (12-24VDC) ≤480mV (48VDC) | 0-70°C (32 to 158°F) ≤120mV (24VDC) ≤240mV (48VDC) (-20) -0°C (-13 to 32°F) ≤240mV (24VDC) ≤480mV (48VDC) |
| Hold up Time 115VAC 230VAC | | 20ms 50ms | | 15ms 50ms | ≥10ms ≥20ms | ≥10ms ≥20ms |
| Set-up Time 115VAC 230VAC | | ≤1s ≤1s | | ≤2s ≤2s | ≤3ms ≤1.2s | ≤2s |
| Rise Time | | 150ms | | | <60mS | <100mS |
| Turn-on overshoot | | < +5%, lo nom, 25°C | | | <5.0% | |
| Overshoot and Undershoot | | < +5%, lo nom, 25°C / < -5%, lo nom, 25°C | | | ≤5.0% | |
| Series Operation | | Yes | | | | |
| Parallel Operation | | No | | | | |
| Power Boost | | No | | | | |

(All specifications are at nominal values, full load, 25°C unless otherwise stated)

Performance

Current derating

SPDM 30W - 50W - 75W 12VDC / 24VDC

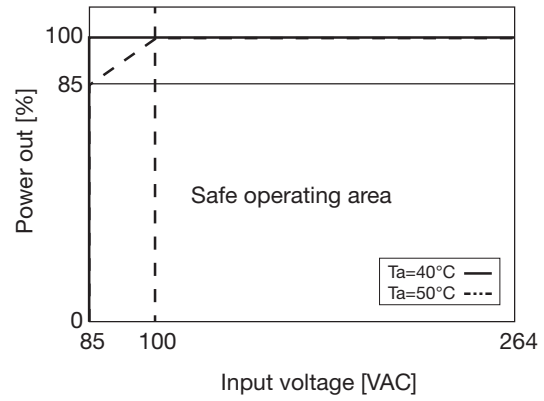
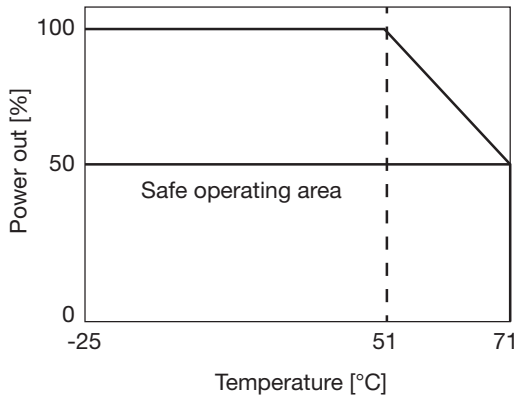

SPDM 120W 12VDC / 24VDC / 48VDC

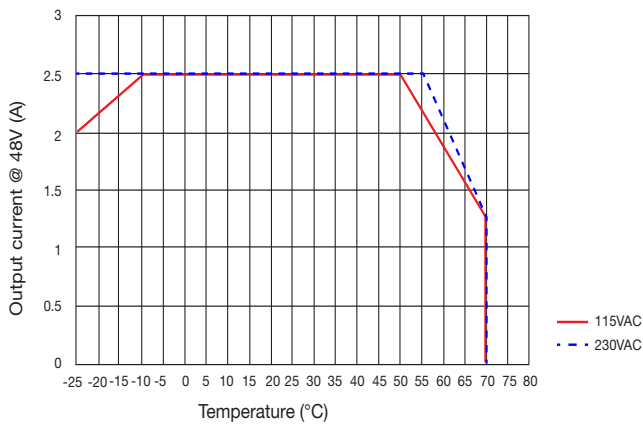
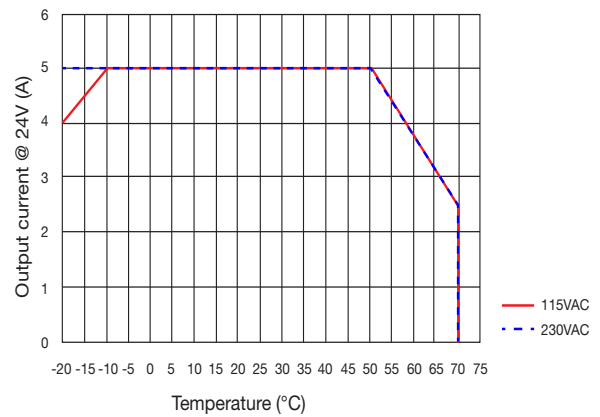
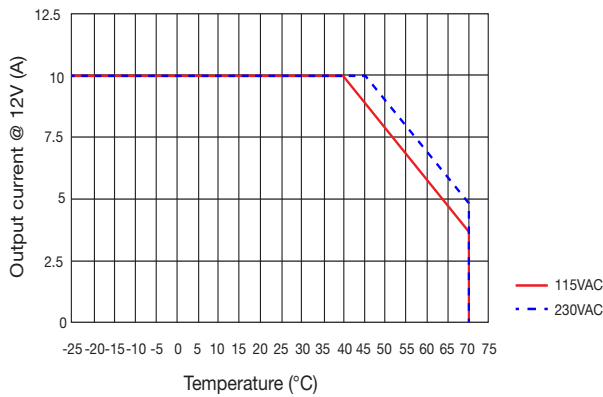

SPDM



SPDM 240W 24VDC / 48VDC

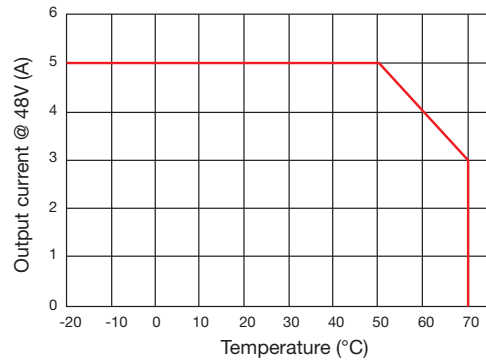
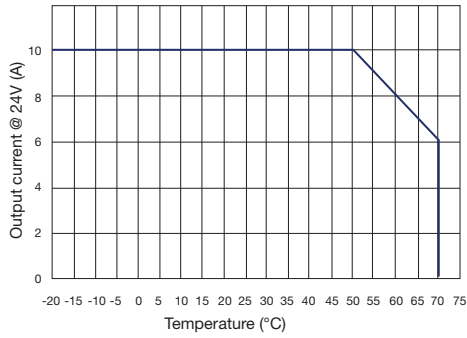

Typical current limited curve

SPDM 30W / 50W / 75W 12VDC / 24VDC @110VAC

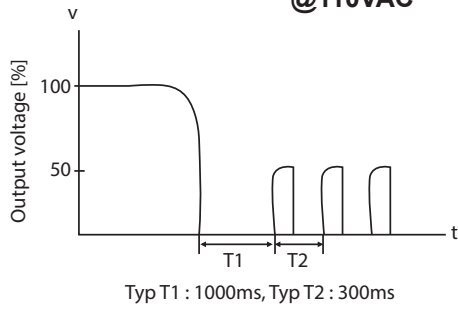

SPDM 30W / 50W / 75W 12VDC / 24VDC @230VAC

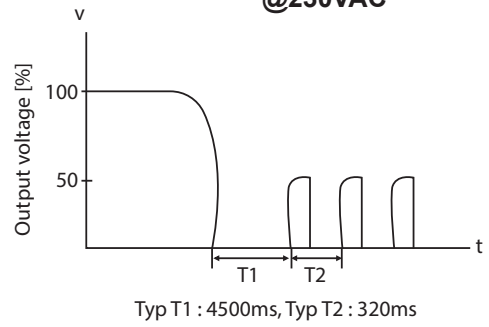

SPDM



**SPDM 120W 12VDC / 24VDC / 48VDC
@ 110 VAC**

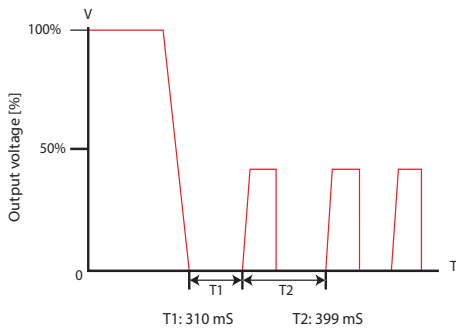

**SPDM 120W 12VDC / 24VDC / 48VDC
@ 230 VAC**

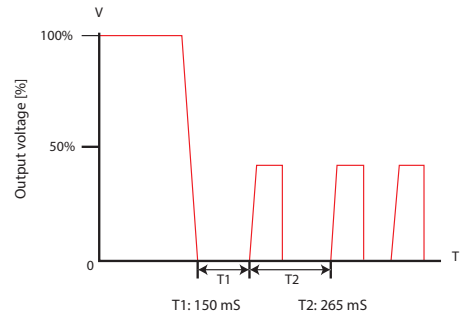

**SPDM 240W 24VDC / 48VDC
@ 110VAC**

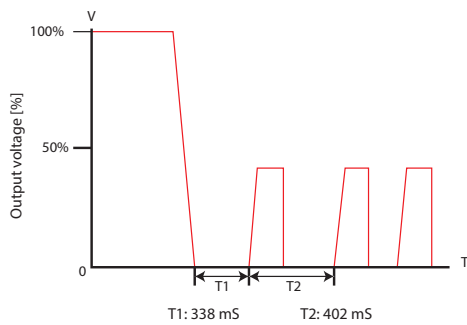

**SPDM 240W 24VDC / 48VDC
@ 230VAC**

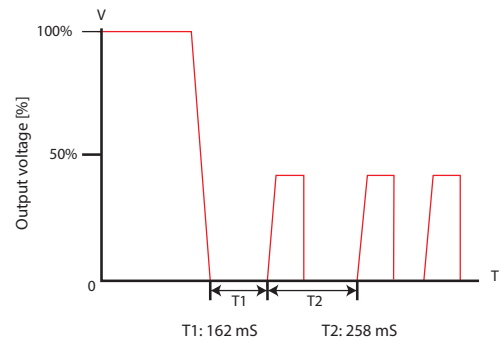

Output Characteristics

SPDM 30W 12VDC

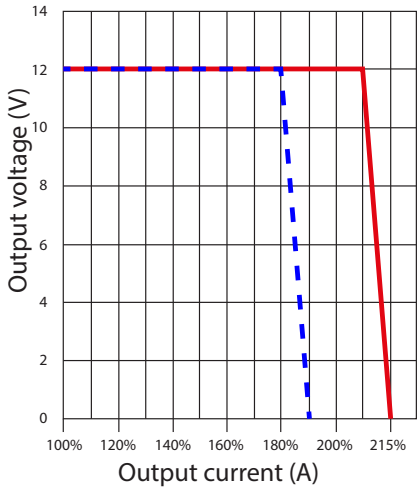

SPDM 30W 24VDC

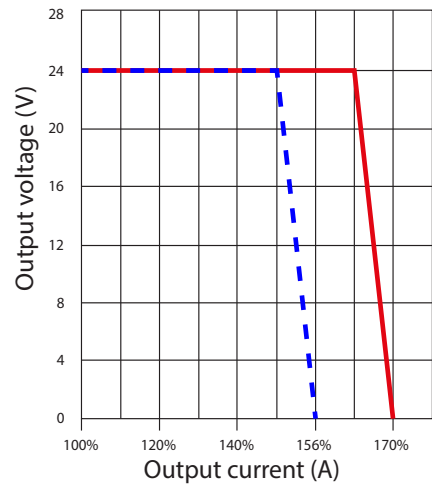

— @ 110VAC

— @ 230VAC

SPDM 50W 12VDC

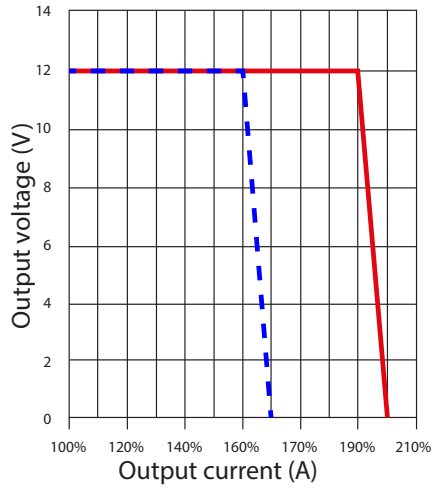

SPDM 50W 24VDC

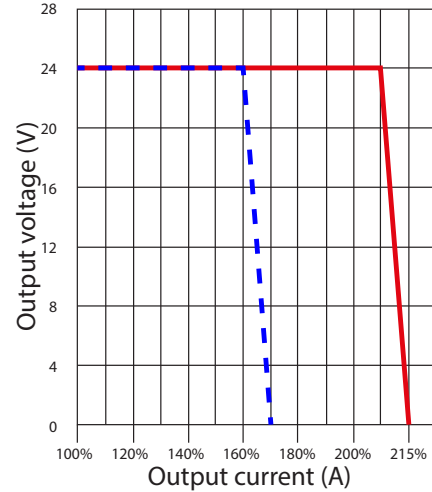

SPDM 75W 12VDC

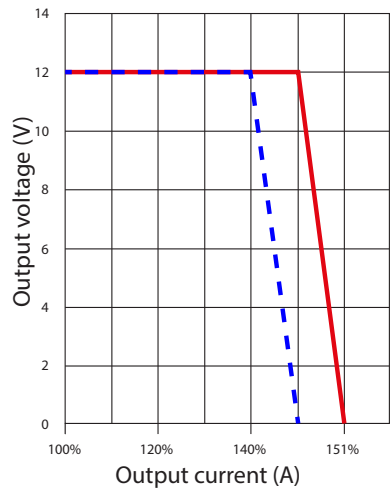

SPDM 75W 24VDC

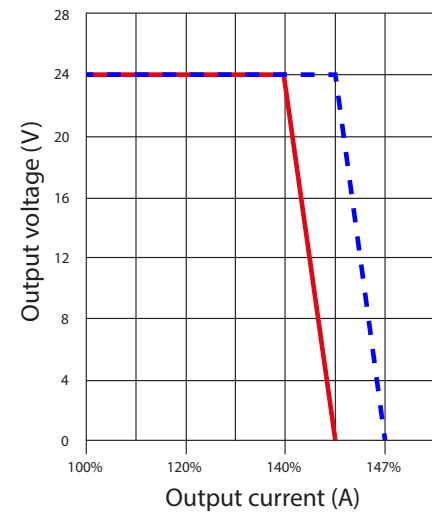

SPDM 120W 12VDC

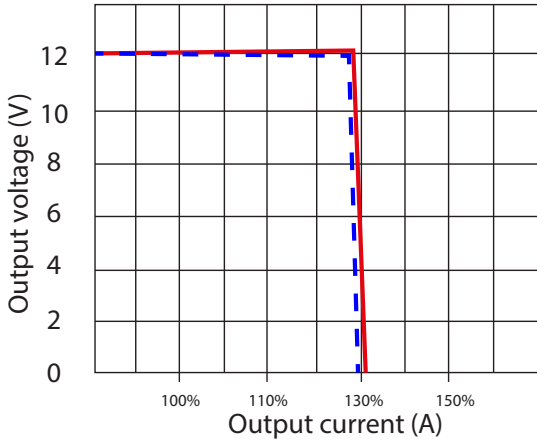

SPDM 120W 24VDC

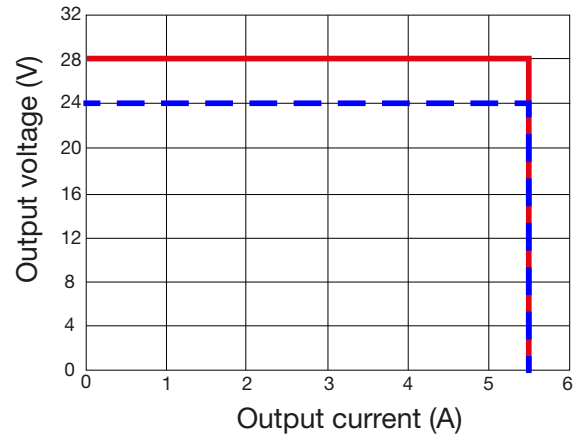

@ 110VAC

—
@ 230VAC

SPDM 120W 48VDC

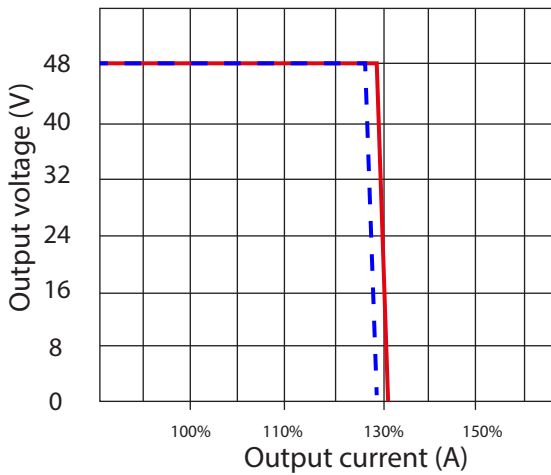

SPDM 240W 24VDC

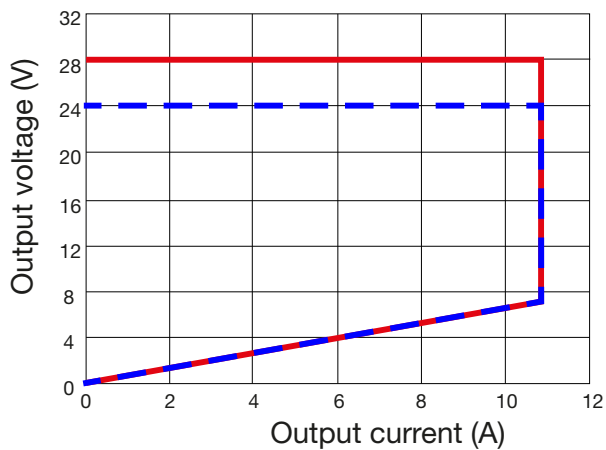

SPDM 240W 48VDC

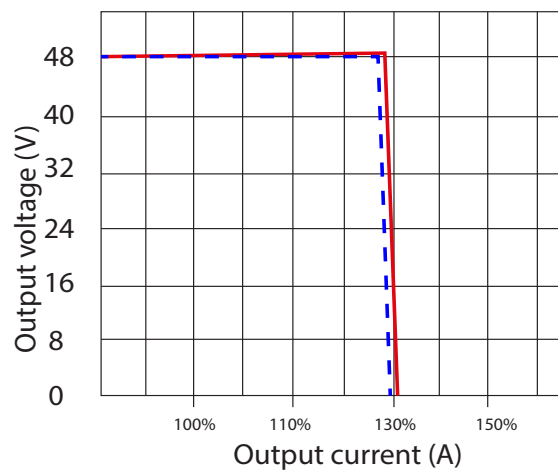

Typical efficiency curve

SPDM 30W 12VDC / 24VDC

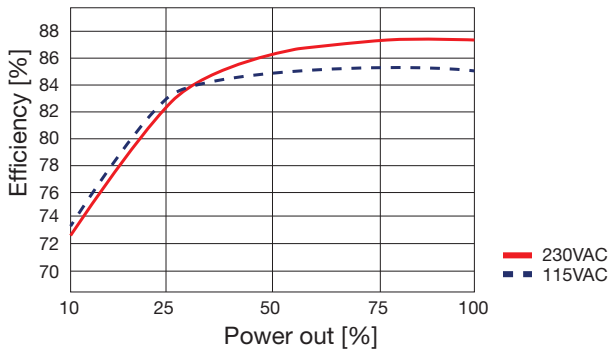

SPDM 50W 12VDC / 24VDC

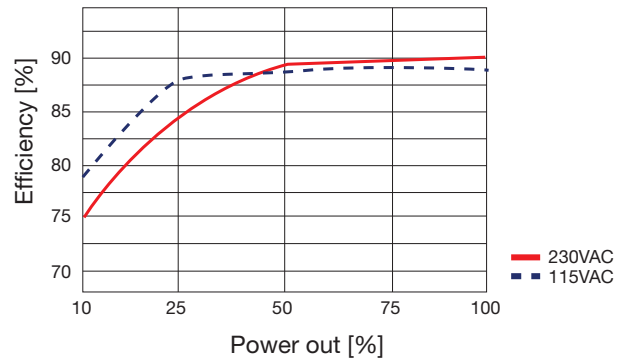

SPDM 75W 12VDC / 24VDC

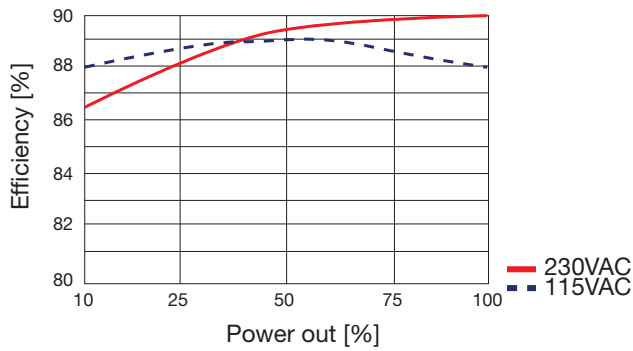

SPDM 120W 12VDC / 24VDC / 48VDC

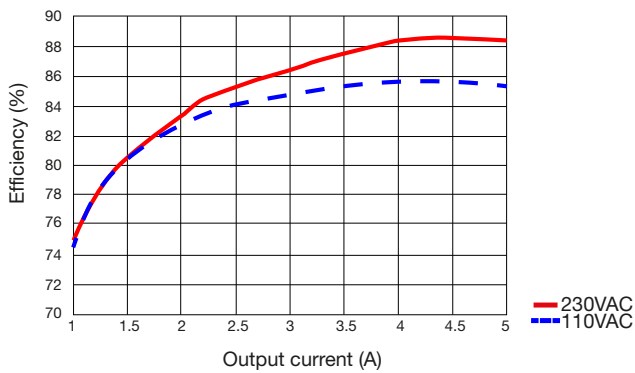

SPDM 240W 24VDC / 48VDC

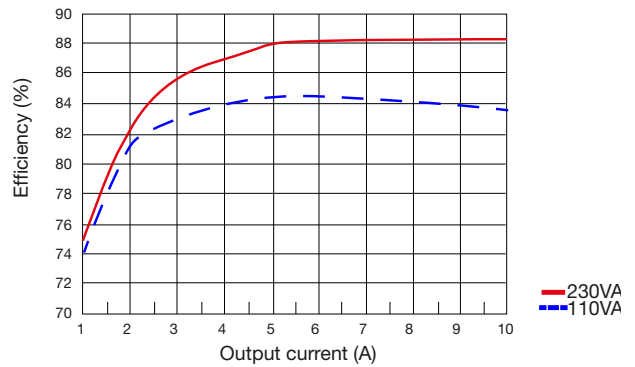

Installation

| | SPDM 30W | SPDM 50W | SPDM 75W | SPDM 120W | SPDM 240W |
|-------------------------|---|----------|----------|-----------|-----------|
| Ventilation and Cooling | Normal air convection; 25mm of free space on each side is recommended | | | | |

SPDM 30W / 12VDC

Mounting A

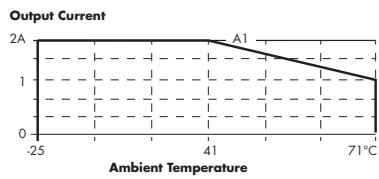
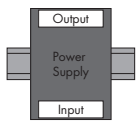

SPDM 30W / 24VDC

Mounting A

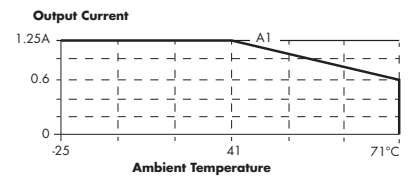
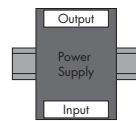

SPDM 50W / 12VDC

Mounting A

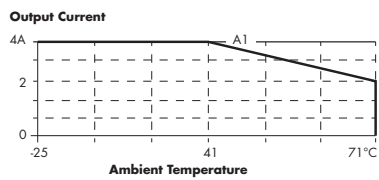
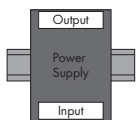

SPDM 50W / 24VDC

Mounting A

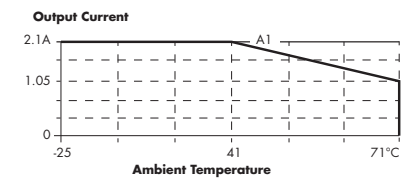
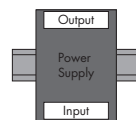

SPDM 75W / 12VDC

Mounting A

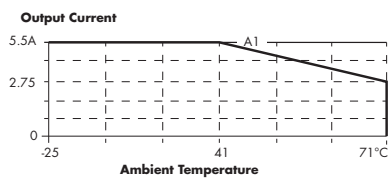
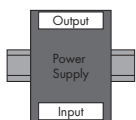

SPDM 75W / 24VDC

Mounting A

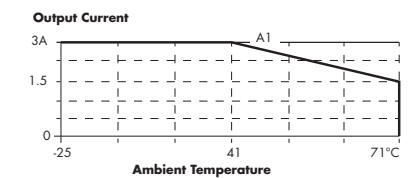
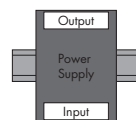

SPDM 30W / 12VDC

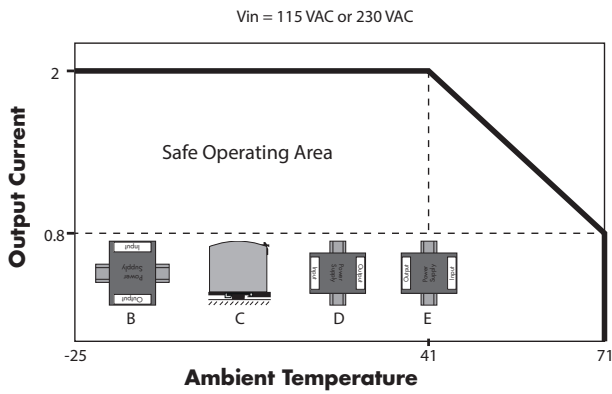

SPDM 30W / 24VDC

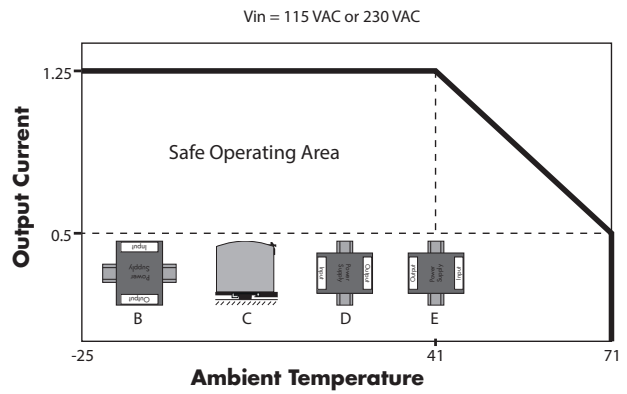

SPDM 50W / 12VDC

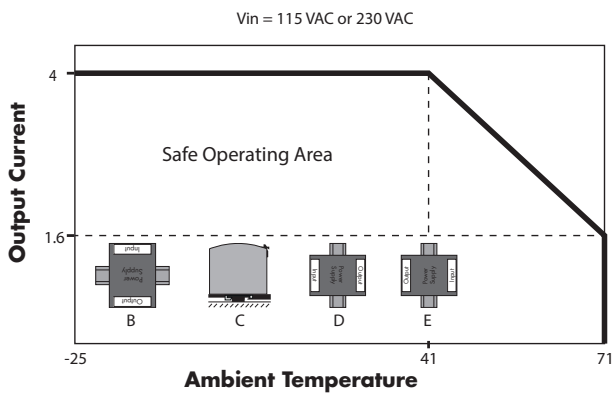

SPDM 50W / 24VDC

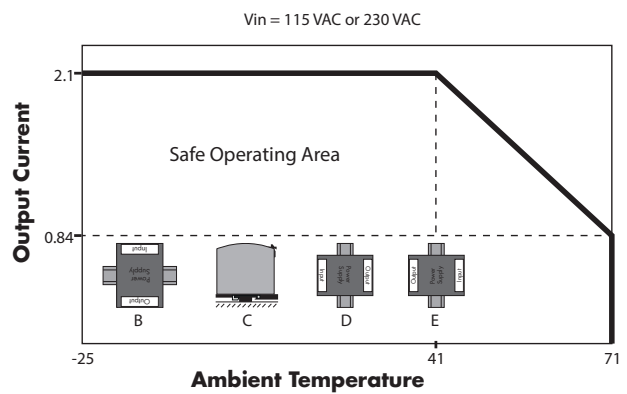

SPDM 75W / 12VDC

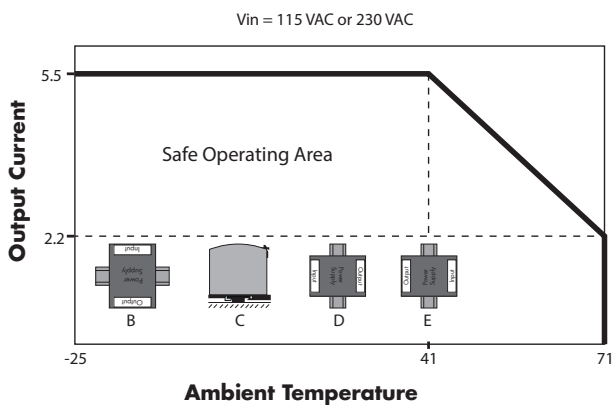

SPDM 75W / 24VDC

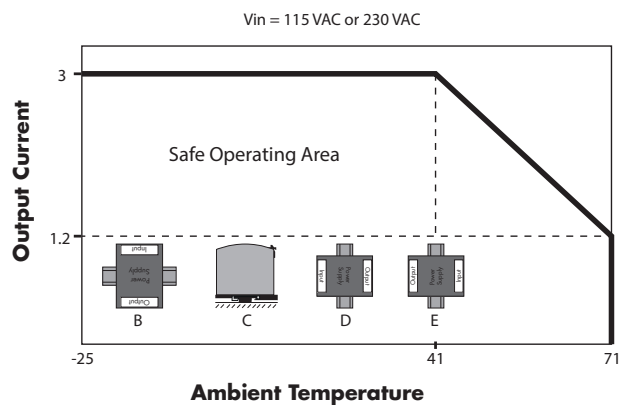

SPDM 120W / 12VDC

SPDM 120W / 24VDC

Mounting A

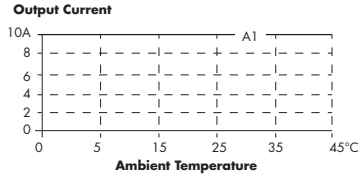
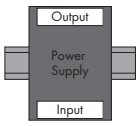

Mounting B

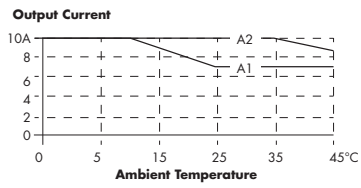
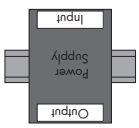

Mounting C

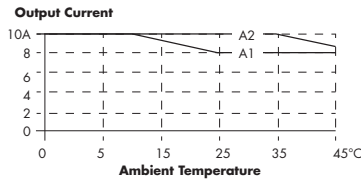

Mounting D

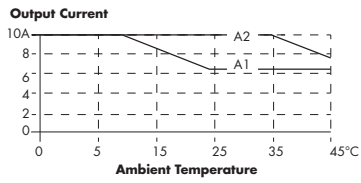
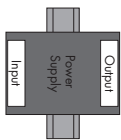

Mounting E

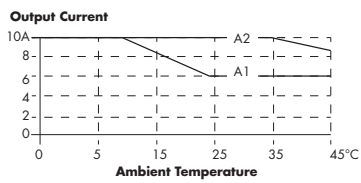
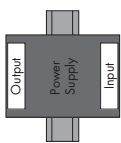

Mounting A

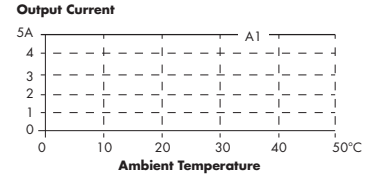
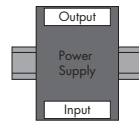

Mounting B

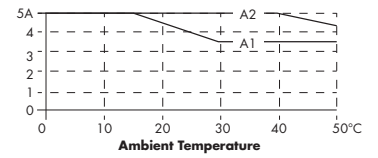
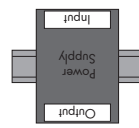

Mounting C

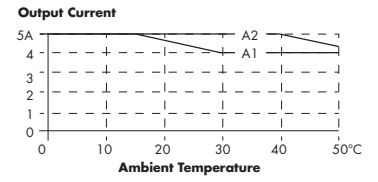
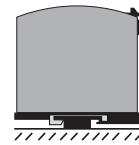

Mounting D

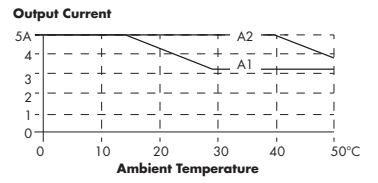
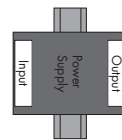

Mounting E

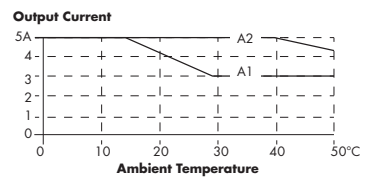
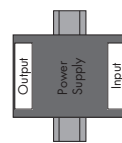

SPDM



SPDM 120W / 48VDC

Mounting A

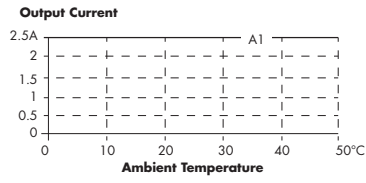
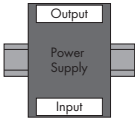

Mounting B

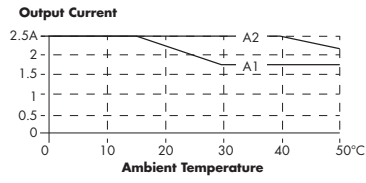
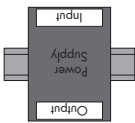

Mounting C

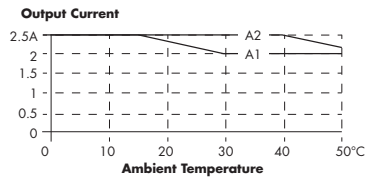
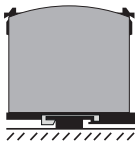

Mounting D

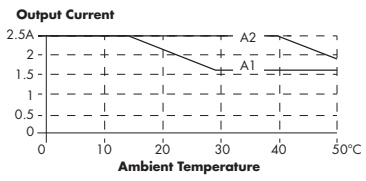
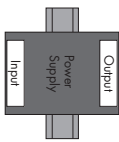

Mounting E

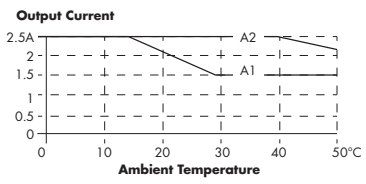
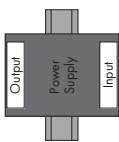

SPDM 240W / 24VDC

SPDM 240W / 48VDC

Mounting A

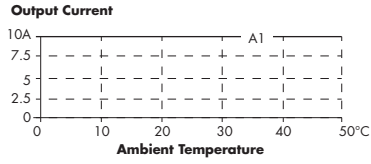
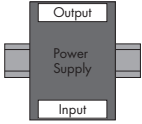

Mounting B

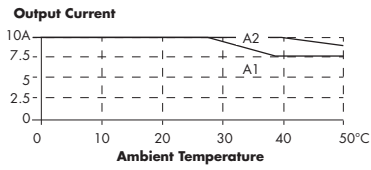
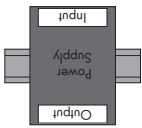

Mounting C

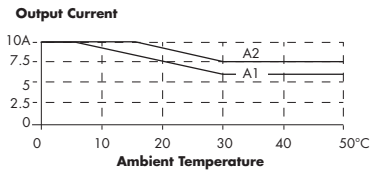
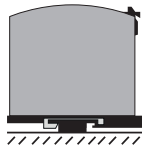

Mounting D

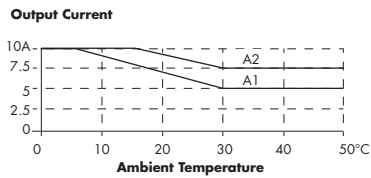
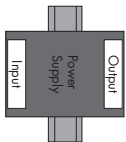

Mounting E

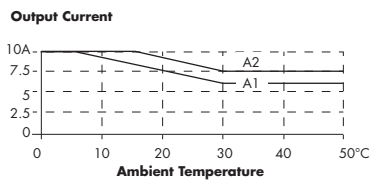
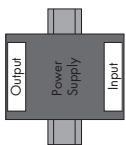

Mounting A

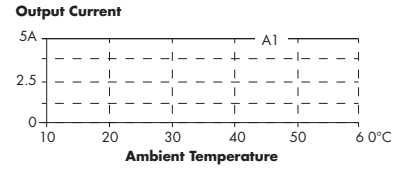
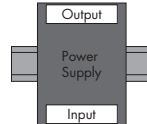

Mounting B

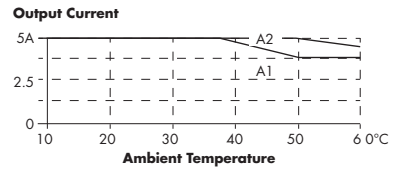
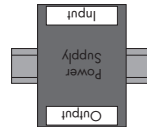

Mounting C

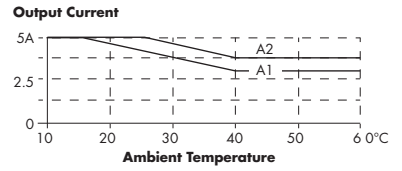
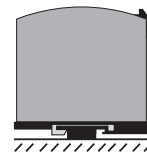

Mounting D

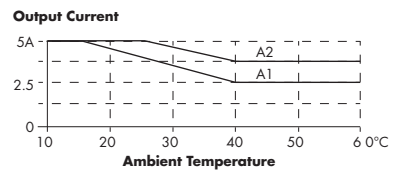
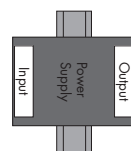

Mounting E

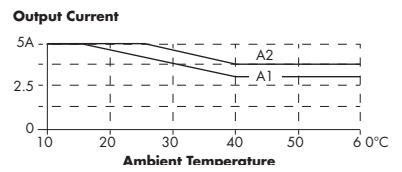
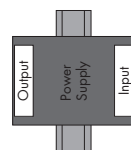

▶ Wiring diagram

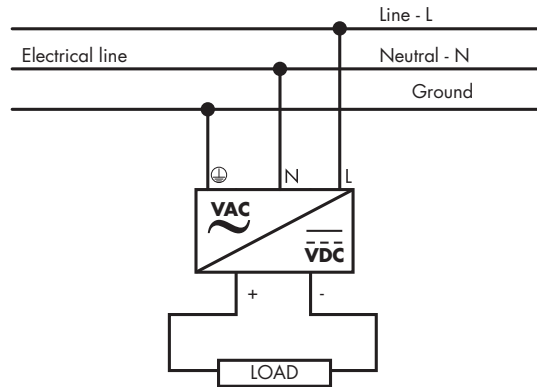

▶ Connection specification

| | SPDM 30W | SPDM 50W | SPDM 75W | SPDM 120W | SPDM 240W |
|---|--|----------|----------|------------------------------------|-----------|
| Terminal type | SCREW or SPRING Terminal Type | | | Input 6.35mm, 3pin screw terminals | |
| Screw driver blade | Philips 1 (PH 1) | | | 3.5mm slotted or cross screwdriver | |
| Tightening torque (Recommended) | 5Nm | | | 5Nm | |
| Flexible conductor Cross section Max | 2.5mm ² (screw) 2.0mm ² (spring) | | | 4mm ² | |
| Flexible conductor Cross section Min | 0.2mm ² | | | 0.5mm ² | |
| Conductor Cross section AWG Max | AWG26 (Screw) AWG 24 (Spring) | | | AWG20 (PG wire >18AWG) | |
| Conductor Cross section AWG Min | AWG12 (Screw) AWG 14 (Spring) | | | AWG10 (PG wire >18AWG) | |
| Rigid conductor Cross-section Min | 2.5mm ² (screw) 2.0mm ² (spring) | | | 6mm ² | |
| Rigid conductor Cross-section Max | 0.2mm ² | | | 0.5mm ² | |
| Max Wire Diameter | Spring terminal: AWG24-14 (0.2~ 2mm ²) Screw terminal: AWG26-12 (0.2~2.5mm ²) | | | 2.8mm ² | |

Block diagram

SPDM 30W / 50W / 75W

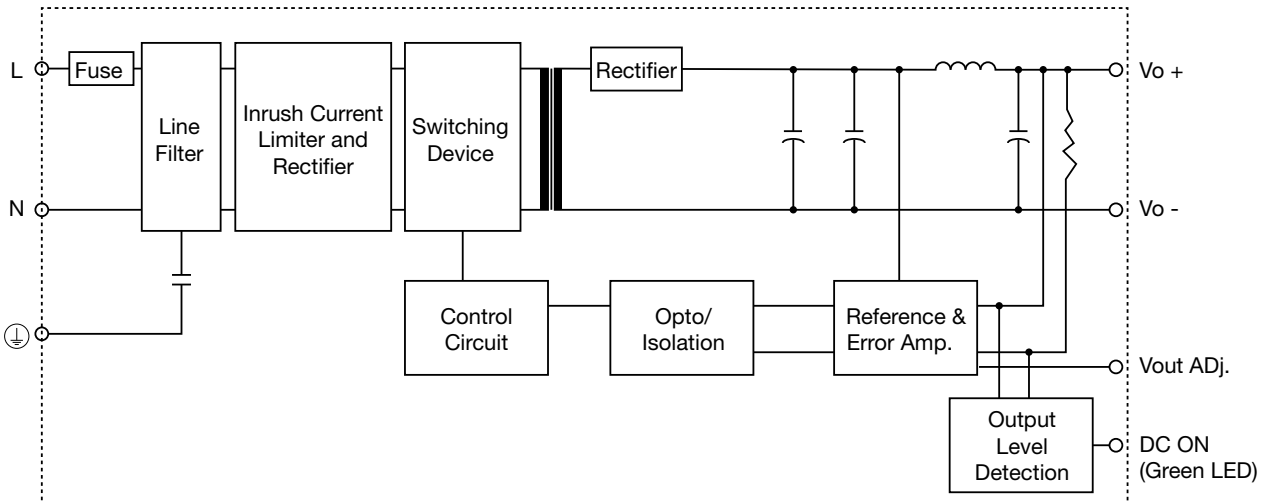

SPDM 120W / 240W

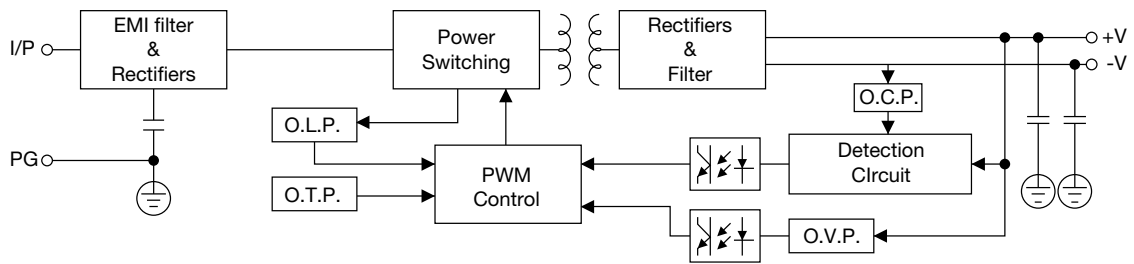

Troubleshooting

▶ Signaling and controls

| | SPDM 30W | SPDM 50W | SPDM 75W | SPDM 120W | SPDM 240W |
|-------------------|---|----------|----------|-----------|-----------|
| DC OK LED | Green | | | | |
| DC OK output type | No | | | | |
| OK threshold | 9.6VDC to 10.8VDC (12VDC) 19.2 VDCto 21.6VDC (24VDC) | | | / | / |

Operating description

▶ Control and protection

| | SPDM 30W | SPDM 50W | SPDM 75W | SPDM 120W | SPDM 240W |
|-----------------------------------|--|----------|----------|--|---|
| Overvoltage protection | 16-18VDC (12VDC) 28.8-32.4VDC (24VDC) | | | 15-18VDC (12VDC) 29-33VDC (24VDC) 58-63VDC (48VDC) | 28-35VDC (24VDC) 58-63VDC (48VDC) |
| Overload protection | 140% | | | 10.5-13A (12VDC) 5.25-6.5A (24VDC) 2.75-3.25A (48VDC) | 10.3-11.5A (24VDC) 5.55-6.5A (48VDC) |
| Current Limiting | / | | | / | / |
| Short Circuit protection | Hiccup mode | | | Long-term mode, auto recovery | |
| Over temperature protection | - | | | 100±5°C, detect on heat sink of power transistor; shut down O/P, re-power on | |
| Internal voltage surge protection | Varistor | | | NTC | |
| Reverse voltage protection | No | | | | |

Glossary



CE: "Conformité Européene" or "European Conformity" ; Indicates the manufacturer declaration of conformity that the product meets the relevant health, safety and environmental protection requirements of the applicable EC directives.



cULus: This certification mark is based on the UL508 ; Standard for Industrial Control Equipment. The UL508 covers industrial control devices and devices accessory for starting, stopping, regulating, controlling, or protecting electric motors. In addition, UL508 also covers devices rated 1500 volts or less. Industrial control equipment covered by these requirements is intended for use in an ambient temperature of 0 – 40°C (32 – 104°F).



UL1310: The UL1310 Class 2 units utilize an isolating transformer and may incorporate components to provide an alternating- or direct-current output. Each output provides Class 2 power levels in accordance with the National Electrical Code, ANSI/NFPA 70. Maximum output voltage does not exceed 42.4 V peak for alternating current, 60 V for continuous direct current. These products are intended primarily to provide power to low voltage, electrically operated devices.



cRUus: This certification mark is based on the UL60950-1 ; Information Technology Equipment - Safety - Part 1. The UL60950-1 is applicable to mains-powered or battery-powered information technology equipment, including electrical business equipment and associated equipment, with a RATED VOLTAGE not exceeding 600 V.



Economical: The SPDM is the most economical power supply, offering features and space saving while lowering the cost.



Spring Terminals: The SPDM 30W, 50W and 75W provide the option of spring terminals, saving installation time by up to 50%.



Reduced dimension: The footprint is reduced with the SPDM, saving up to 30% space when compared to others.

X-ON Electronics

Largest Supplier of Electrical and Electronic Components

Click to view similar products for [DIN Rail Power Supplies](#) category:

Click to view products by [Carlo Gavazzi](#) manufacturer:

Other Similar products are found below :

[PS-S6024](#) [DVP01PU-S](#) [DVP06AD-S](#) [DVP06XA-S](#) [DVDPNET-SL](#) [DVPDT01-S](#) [DVPPS01](#) [PS-6012](#) [PS9Z-5R1G](#) [PS-C24024](#)
[DVP08ST11N](#) [DVPACAB530](#) [DVPCOPM-SL](#) [DVPEN01-SL](#) [DVPPF01-S](#) [ADNB008-48-1PM-C](#) [ADNB017-24-1PM-C](#) [ADNB040-24-1PM-C](#) [ADNB050-12-1PM-C](#) [ADNB040-15-1PM-C](#) [ADNB034-12-1PM-C](#) [S8TS-06024-E1](#) [PS-UPS40](#) [PSC-6024](#) [PSD-A60W12](#) [96PS-A120WDIN](#) [PSD-A60W48](#) [PSD-A40W12](#) [PSD-A40W24](#) [SMP21-L20-DC24V-5A](#) [PSD-A40W48](#) [S8T-DCBU-02](#) [PS-S4024](#) [NTPS-24-1.3](#)
[PST-96024](#) [S82YVSC4P](#) [PS-S4005](#) [PS-10024](#) [PS-S10024](#) [PS-C12024](#) [PSP-480S24](#) [PS-C48024](#) [PSC-2024](#) [PSC-4012](#) [PSC-4015](#) [PSC-4048](#)
[PSC-9615](#) [PSC-15124](#) [PSC-15148](#) [PSC-24148](#)