

# Ultrasonic Diffuse, Digital Output Types UA30CAD.....TI

CARLO GAVAZZI



- Cylindrical M30 PBT housing
- Sensing distance: 250-3500 mm
- Power supply: 12 to 30 VDC
- Outputs: Two multi function switching outputs. PNP or NPN
- Setup: Normal switching or adjustable hysteresis
- Repeatability 0.2%
- Beam angle.  $\pm 6^\circ$
- Protection: Short-circuit, reverse polarity and overvoltage
- Protection degree IP 67, Nema 4X
- 2 m cable or M12 plug



## Product Description

A self-contained multi function diffuse ultrasonic sensor with a sensing range of 250 to 3500 mm. 2 switching outputs - easily set up for two different output modes and adjusted by teach-in - makes it ideal for level control tasks in a wide variety of vessels. A sturdy one-piece polyester

housing provides the perfect packaging for the sophisticated microprocessor controlled and digitally filtered sensor electronics. Excellent EMC performance and precision are typical features of this sensor on true distance measurement.

## Ordering Key

**UA30CAD35NPM1TI**

Ultrasonic sensor	_____
Housing style	_____
Housing size	_____
Housing material	_____
Housing length	_____
Detection principle	_____
Sensing distance	_____
Output type	_____
Output configuration	_____
Connection	_____
Teach-in	_____

## Type Selection

Housing diameter	Connection	Rated operating dist. ( $S_n$ )	Digital output NPN/PNP	Ordering no.
M30	Plug M12	250-3500 mm	2 x NPN	<b>UA 30 CAD 35 NP M1 TI</b>
M30	Cable	250-3500 mm	2 x NPN	<b>UA 30 CAD 35 NP TI</b>
M30	Plug M12	250-3500 mm	2 x PNP	<b>UA 30 CAD 35 PP M1 TI</b>
M30	Cable	250-3500 mm	2 x PNP	<b>UA 30 CAD 35 PP TI</b>

## Specifications

<b>Rated operating distance (<math>S_n</math>)</b>	Reference target: 1 mm metal rolled finish, size 200 x 200 mm. 250 - 3500 mm	Max. load capacity 100 nF UL508 specification	$\leq 300$ mA $\leq 100$ mA
<b>Blind zone</b>	$\leq 250$ mm	<b>Output current short-time (I)</b> Max. load capacity 100 nF UL508 specification	$\leq 300$ mA $\leq 100$ mA
<b>Repeatability</b>	0.2%	<b>Minimum operational current (<math>I_m</math>)</b>	$\leq 0.5$ mA
<b>Beam angle</b>	$\pm 6^\circ$	<b>OFF-state current (<math>I_o</math>)</b>	$\leq 10$ $\mu$ A
<b>Adjustment</b> Push-button	P1 (farthest setpoint) P2 (nearest setpoint)	<b>Voltage drop (<math>U_d</math>)</b>	$\leq 2.2$ VDC @ 100 mA
<b>Temperature drift</b>	$\leq 0.1\%/^\circ\text{C}$ @ $-20^\circ$ to $+70^\circ$ C	<b>Protection</b>	Short-circuit, overvoltage and reverse polarity
<b>Temperature compensation</b>	Yes	<b>Carrier frequency</b>	112 kHz
<b>Hysteresis (H)</b>	Min. 0.5%	<b>Operating frequency (f)</b>	$\leq 2$ Hz
<b>Rated operational voltage (<math>U_B</math>)</b>	12 to 30 VDC (ripple included)	<b>Response time OFF-ON (<math>t_{ON}</math>)</b>	$\leq 250$ ms
<b>Ripple (<math>U_{rpp}</math>)</b>	$\leq 5\%$	<b>Response time ON-OFF (<math>t_{OFF}</math>)</b>	$\leq 250$ ms
<b>No-load supply current (<math>I_o</math>)</b>	$\leq 50$ mA @ $U_B$ max	<b>Power ON delay</b>	$\leq 500$ ms
<b>Output current continuous (<math>I_o</math>)</b>		<b>Output function, open collector</b>	

## Specifications (cont.)

By sensor type	NPN or PNP	<b>Rated insulation voltage</b>	< 500 VAC (rms)
<b>Output switching function</b>	Two open collector transistor outputs to be configured as: - Normal Switching function with N.O output. - Adjustable hysteresis Filling or emptying control	<b>Housing</b>	Material body: PBT Material front: Epoxy-glass resin Material back, plug: Grilamid Material back, cable: Grilamid Material push-button: TPE Sealing around push-button: TPE Material sealing front: TPE
<b>Indication</b>	Output ON: Yellow LED Echo received: Green LED	<b>Connection</b>	Cable: PVC, grey, 2 m, 4 x 0.34 mm <sup>2</sup> , Ø = 4.7 mm Plug: M12, 4-pin (CON. 14-series)
<b>Environment</b>	Installation category: III (IEC 60664/60664A; 60947-1) Pollution degree: 3 (IEC 60664/60664A; 60947-1) Degree of protection: IP67 (IEC 60529; 60947-1) Nema 4X	<b>Tightening torque</b>	≤ 1.5 Nm
<b>Ambient temperature</b>	Operating: -20° to +70°C (-4° to +158°F) Storage: -35° to +70°C (-31° to +158°F)	<b>Weight</b>	Cable version: 160 g Plug version: 90 g
<b>Vibration</b>	10 to 55 Hz, 1.0 mm/6G. (IEC/EN 60068-2-6)	<b>CE-marking</b>	Yes
<b>Shock</b>	30 g / 11 mS, 3 directions (IEC/EN 60068-2-27)	<b>Approvals</b>	cULus (UL508)

## Wiring Diagram

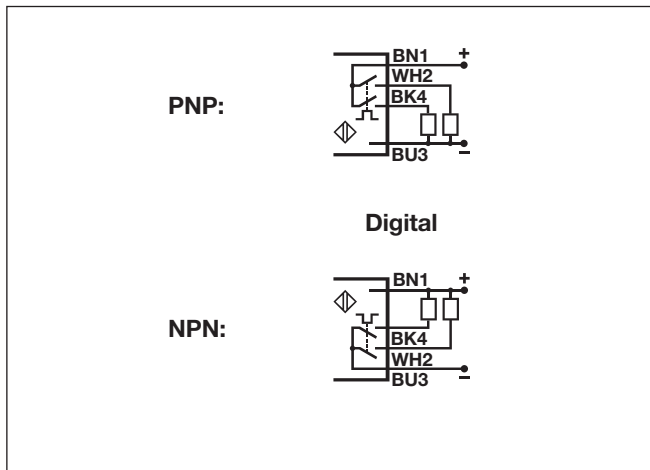

## Detection Range

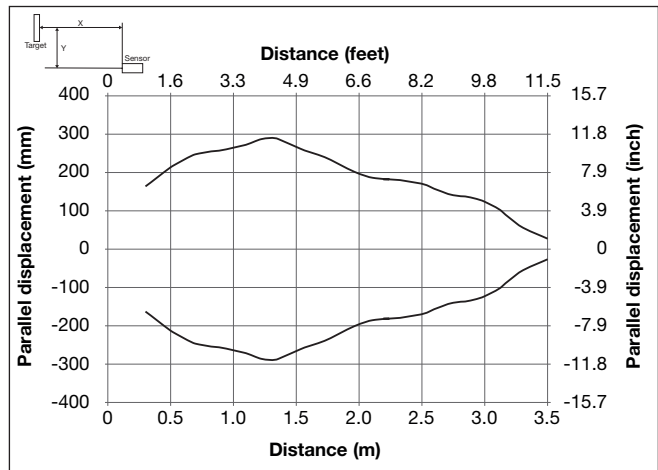

## Dimensions

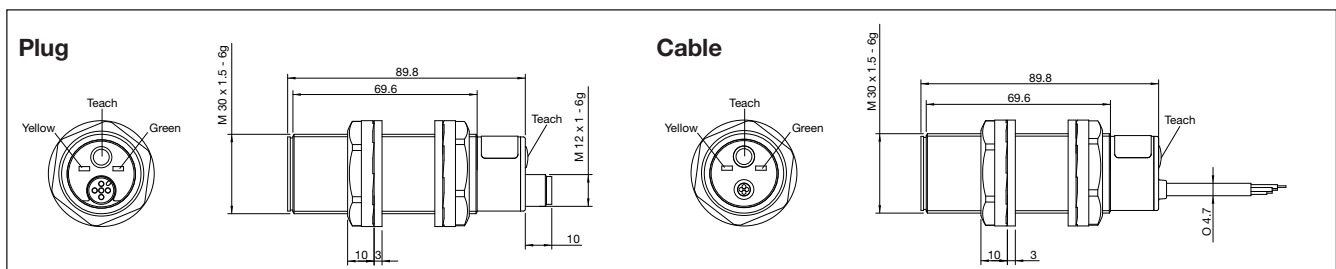

## Programming setup

**General set up of sensing point P1 (longest distance) and P2 (shortest distance) independently of the sensor type or function.**

- 1) Mount the sensor in the selected application.
- 2) Place a target in front of the sensor at the maximum required distance (P1), then press shortly on the teach-button. The yellow LED switches Off and then On again after a maximum of 2 seconds. Now, the distance (P1) is saved in the sensor, and the target can be moved. I)
- 3) Place the target at the minimum distance requested (P2), then press shortly on the teach-button. The yellow LED turns Off and then flashes 5 times. Now, the distance (P2) is saved in the sensor and the target can be moved. II)

I) P1 can be set to maximum exceeding the family specification for the sensor by removing the target in front of the sensor. Push and hold the teach-button for more than one second and the sensing distance is set at a unique distance for this sensor only.

II) The second switch point can be set to minimum by setting the target within the blind zone close to the sensor head or by covering the sensor head with your hand while teaching P2.

**Sensors with 2 digital outputs: UA..CAD..PP/NP types, Normal sensing function or Adjustable Hysteresis**

- 1) The factory settings are normal sensing function.

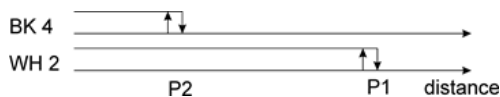

- 2) Push and hold the teach-button for 8 seconds (12 for UC18CAD22..) until the yellow LED flashes fast, then release the teach-button and the LED will flash 5 times to acknowledge the change in function. Now, the sensor is in adjustable hysteresis mode.

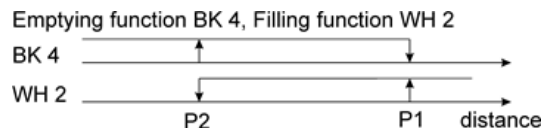

- 3) To switch back to normal function, repeat step 2.

## Installation Hints

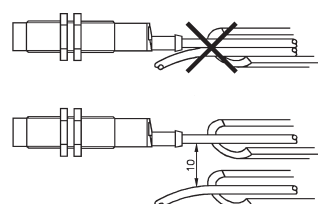
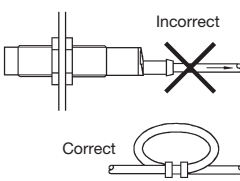
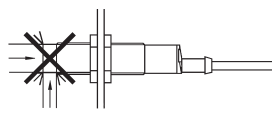
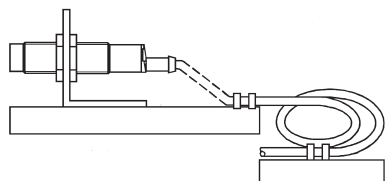
<p>To avoid interference from inductive voltage/current peaks, separate the prox. switch power cables from any other power cables, e.g. motor, contactor or solenoid cables</p> 	<p>Relief of cable strain</p>  <p>The cable should not be pulled</p>	<p>Protection of the sensing face</p>  <p>A proximity switch should not serve as mechanical stop</p>	<p>Switch mounted on mobile carrier</p>  <p>Any repetitive flexing of the cable should be avoided</p>
---	---	--	--

## Delivery Contents

- Ultrasonic sensor: UA30CAD....
- Installation instruction
- Mounting:
  - 2 x M30 Nuts
  - 2 x rubber washers
- Packaging: Carton box 35 x 107 x 173 mm

## Accessories

- Connector type COBM14NF.. series

## X-ON Electronics

Largest Supplier of Electrical and Electronic Components

*Click to view similar products for [Proximity Sensors](#) category:*

*Click to view products by [Carlo Gavazzi](#) manufacturer:*

Other Similar products are found below :

[01.001.5653.1](#) [70.340.1028.0](#) [70.360.2428.0](#) [70.364.4828.0](#) [70.810.1053.0](#) [72.360.1628.0](#) [73.363.6428.0](#) [9221350022](#) [980659-1](#) [QT-12](#)  
[E2EX10D1NN](#) [E2E-X14MD1-G](#) [E2E-X2D1-G](#) [E2EX2ME2N](#) [E2E-X3D1-N](#) [10M](#) [E2E-X4MD1-G](#) [E2FMX1R5D12M](#) [E2K-F10MC1](#) [5M](#)  
[EI1204TBOSL-6](#) [EI5515NPAP](#) [BSA-08-25-08](#) [IC08ANC15PO-K](#) [IMM2582C](#) [25.161.3253.0](#) [25.332.0653.1](#) [25.352.0653.0](#) [25.352.0753.0](#)  
[25.523.3253.0](#) [9151710023](#) [922FS1.5C-A4P-Z774](#) [SC606ABV0S30](#) [SM952A126100LE](#) [A1220EUA-T](#) [F3S-A162-U](#) [CL18](#) [QT-08L](#)  
[34.110.0010.0](#) [TL-C2MF1-M3-E4](#) [IA08BLF15NOM5](#) [IA08BSF15NOM5](#) [IA12ASF04DOM1](#) [IMM32188C](#) [IS2](#) [IS31SE5000-UTLS2-TR](#)  
[34.110.0021.0](#) [34.110.0022.0](#) [CA150-120VACDC](#) [VM18VA3000Q](#) [XS508BSCBL2](#) [XS512BLNAM12](#)